

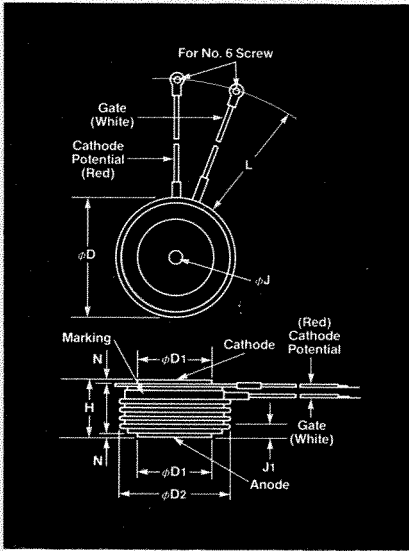

Fast Switching SCR T72H_42

420A Avg.
(650A RMS)
Up to 1800 Volts
80-100 μ s



Symbol	Inches		Millimeters	
	Min.	Max.	Min.	Max.
ϕD	2.250	2.290	57.15	58.17
ϕD_1	1.333	1.343	33.86	34.11
ϕD_2	2.030	2.090	51.56	53.09
H	1.020	1.060	25.91	26.92
ϕJ	.135	.145	3.43	3.68
J_1	.075	.090	1.91	2.29
L	7.75	8.50	196.85	215.90
N	.040		1.02	

Creep Distance—1.00 in. min. (25.40 mm).
Strike Distance—1.02 in. min. (25.91 mm).
(In accordance with NEMA standards.)

Finish—Nickel Plate.

Approx. Weight—8 oz. (227 g).

1. Dimension "H" is a clamped dimension.



T72 Outline

Features:

- Interdigitated, di/namic Gate Structure
- Hard Commutation Turn-Off
- Forward Blocking Voltage Capabilities to 1800 Volts
- Low Switching Losses at High Frequency
- Soft Cummutation (Feedback Diode) Testing Available
- High di/dt

Applications:

- Induction Heating
- Transportation
- Inverters

Ordering Information

Type	Voltage		Current		Turn-off		Gate current		Leads	
	V_{DRM} and V_{RRM} (V)	Code	$I_{T(av)}$ (A)	Code	t_q μ sec	Code	I_{GT} (ma)	Code	Case	Code
T72H	1400 1600 1800	14 16 18	420	42	80 100	1 K	150	4	T72	DN

Example: Obtain optimum device performance for your application by selecting proper Order Code.

Type T72H rated at 420 A average with $V_{DRM} = 1600V$, $I_{GT} = 150$ ma, $t_q = 80 \mu$ sec max. and leads—order as:

Type	Voltage	Current	Turn Off	Gate Current	Leads
T 7 2 H	1 6	4 2	1	4	D N

**420A Avg.
(650A RMS)
Up to 1800 Volts
80-100 μ s**

**Fast Switching
SCR
T72H__42**



Voltage ②

Blocking State Maximums ($T_J = 125^\circ\text{C}$) **Symbol**

Repetitive peak forward blocking voltage, V V_{DRM}
 Repetitive peak reverse voltage, V V_{RRM}
 Non-repetitive transient peak reverse voltage,
 $t \leq 5.0$ msec, V V_{RSM}
 Forward leakage current, mA peak I_{DRM}
 Reverse leakage current, mA peak I_{RRM}

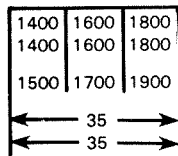

Current

Conducting State Maximums ($T_J = 125^\circ\text{C}$) **Symbol** **T72H__42**

RMS forward current, A I_T (rms) 650
 Ave. forward current, A I_T (av) 420
 One-half cycle surge current ③, A I_{TSM} 6800
 I^2t for fusing (for times ≥ 8.3 ms)
 A² sec I^2t 205,000
 Forward voltage drop at $I_{TM} = 1500\text{A}$
 and $T_J = 25^\circ\text{C}$, V V_{TM} 2.2
 Min. repetitive di/dt ④⑤ A/ μ sec di/dt 400

Switching

($T_J = 25^\circ\text{C}$) **Symbol**

Max. turn-off time, $I_T = 1000\text{A}$, $T_J = 125^\circ\text{C}$,
 $t_p = 100 \mu\text{sec}$, $diR/dt = 50$ ⑥
 A/ μ sec., reapplied $dv/dt =$
 $200 \text{ V}/\mu\text{sec}$ linear to 0.8 V_{DRM} , μsec . ⑦⑧ t_q 80 to 100
 Typ. delay time, $I_{TM} = 1000\text{A}$ t_d 2.0
 $T_D = .8 \text{ V}_{DRM}$ ④, μsec ④
 Typ. turn-on-time $I_{TM} = 1000\text{A}$, μsec t_{on} 3.0
 Min. critical dv/dt exponential to .8
 V_{DRM} $T_J = 125^\circ\text{C}$, V/ μ sec ②③ dv/dt 300
 Min. di/dt non-repetitive, A/ μ sec ①④⑤ di/dt 1200

Gate

Maximum Parameters ($T_J = 25^\circ\text{C}$) **Symbol**

Gate current to trigger at $V_D = 12\text{V}$, mA I_{GT} 150
 Gate voltage to trigger at $V_D = 12\text{V}$, V V_{GT} 3
 Non-triggering gate voltage, $T_J = 125^\circ\text{C}$,
 and rated V_{DRM} , V V_{GDM} .25
 Peak forward gate current, A I_{GTM} 4
 Peak reverse gate voltage, V V_{GRM} 5
 Peak gate power, Watts P_{GM} 16
 Average gate power, Watts $P_{G(av)}$ 3

Thermal and Mechanical

..... **Symbol**

Min., Max. oper. junction temp., $^\circ\text{C}$ T_J -40 to +125
 Min., Max. storage temp., $^\circ\text{C}$ T_{stg} -40 to +150
 Max. mounting force, lb. ① 2000 to 2400
 Thermal resistance ①, double-
 side cooling,
 junction to case, $^\circ\text{C}/\text{Watt}$ $R_{\theta JC}$.06
 Case to sink, lubricated, $^\circ\text{C}/\text{Watt}$ $R_{\theta CS}$.02

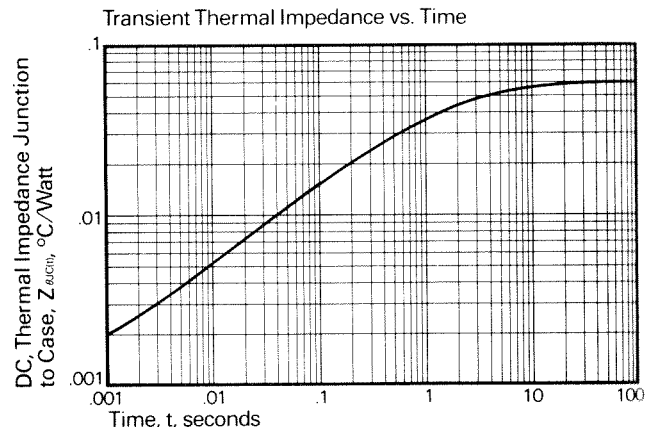
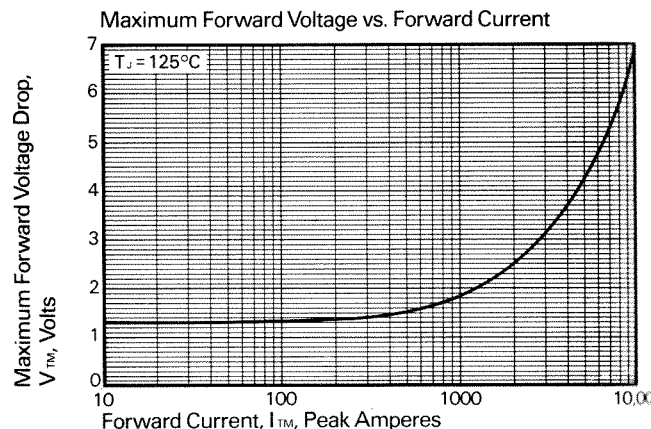

- ① Consult recommended mounting procedures.
- ② Applies for zero or negative gate bias.
- ③ Per JEDEC RS-397, 5.2.2.1.
- ④ With recommended gate drive.
- ⑤ Higher dv/dt ratings available, consult factory.
- ⑥ Per JEDEC standard RS-397, 5.2.2.6.
- ⑦ For operation with antiparallel diode, consult factory.
- ⑧ Other t_q and u_t combinations available consult factory.

FAST SWITCHING THYRISTORS



Fast Switching SCR T72H_42

420A Avg.
(650A RMS)
Up to 1800 Volts
80-100 μ s

Sinusoidal Current Data

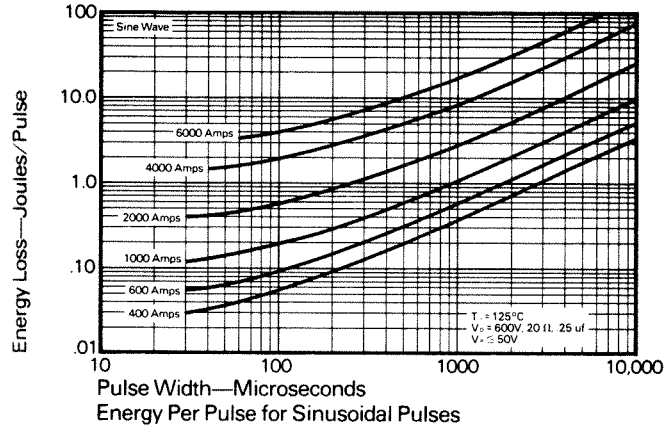

Trapezoidal Wave Current Data

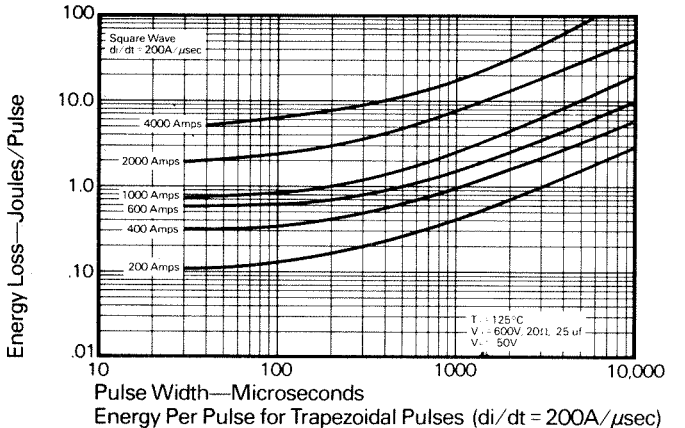
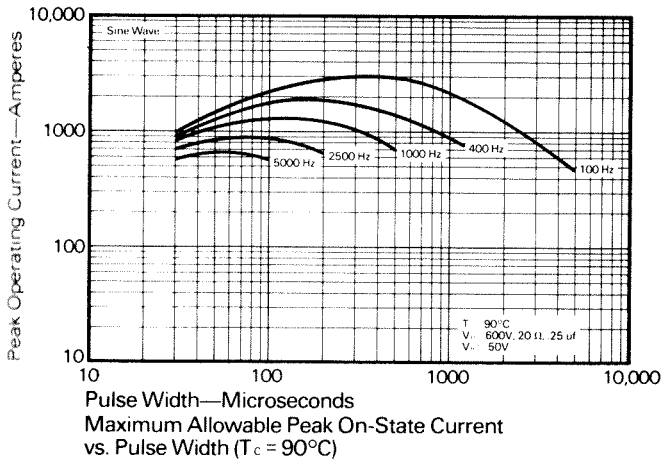
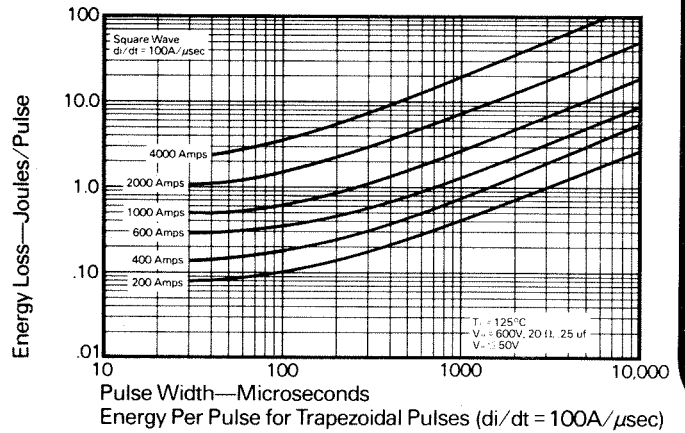
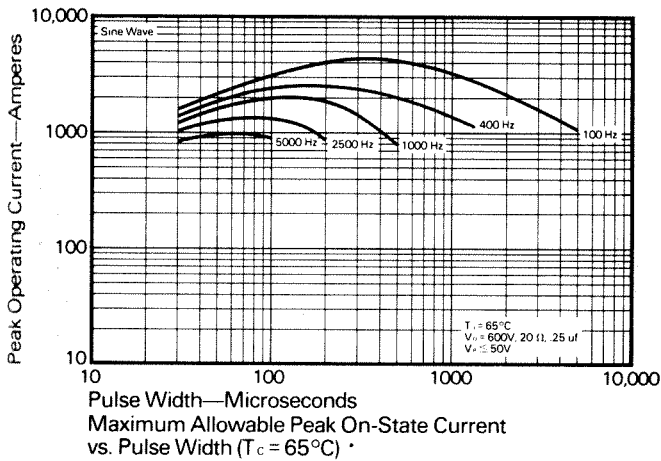
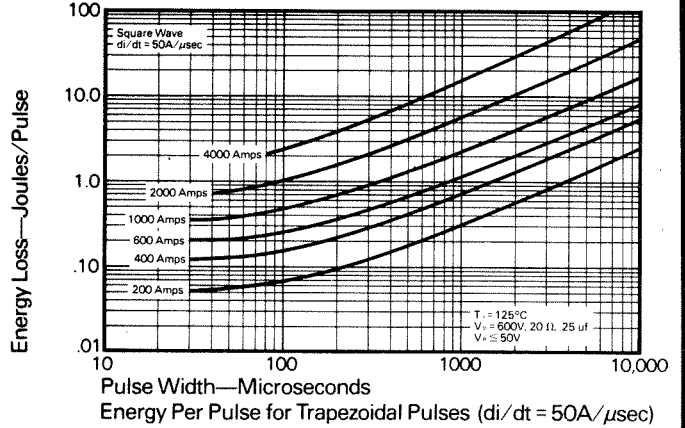

FAST SWITCHING
THYRISTORS

420A Avg.
(650A RMS)
Up to 1800 Volts
80-100 μ s

Fast Switching
SCR
T72H_42



Trapezoidal Wave Current Data ($T_c = 65^\circ\text{C}$)

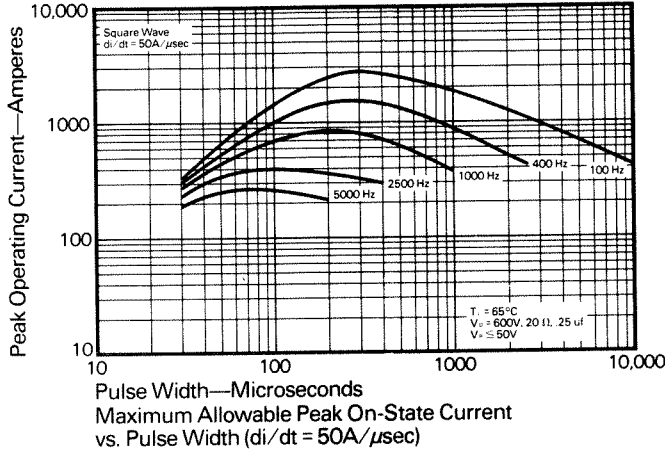

Trapezoidal Wave Current Data ($T_c = 90^\circ\text{C}$)

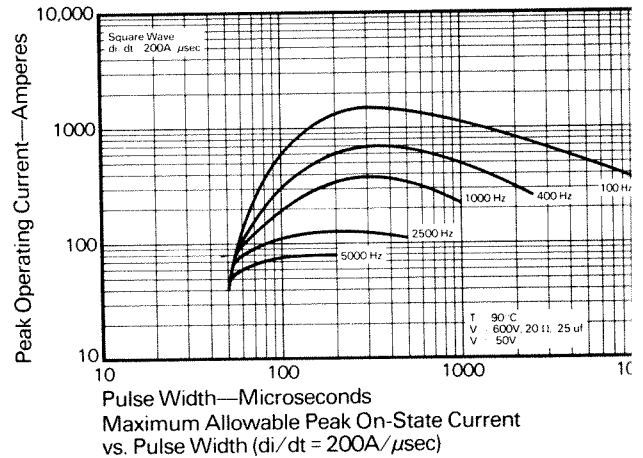
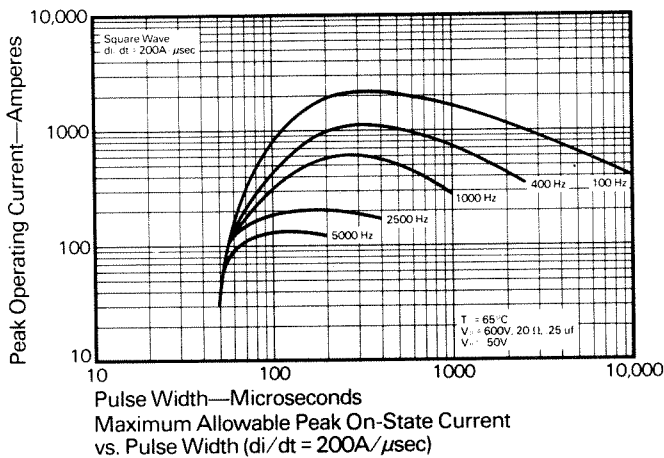
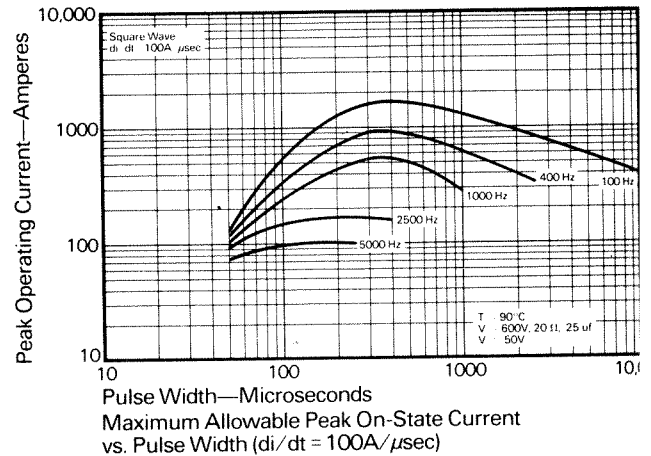
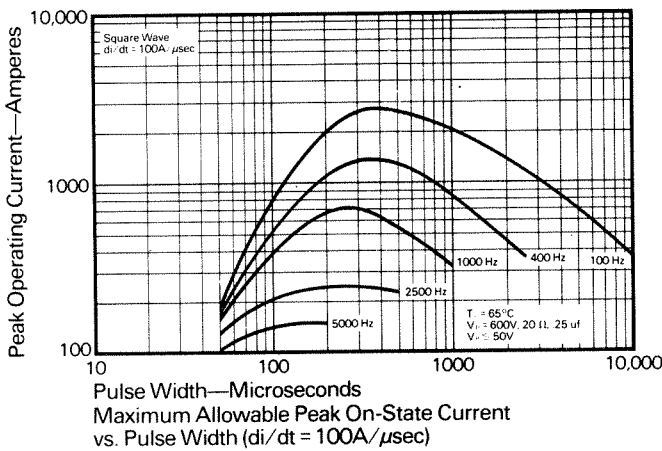
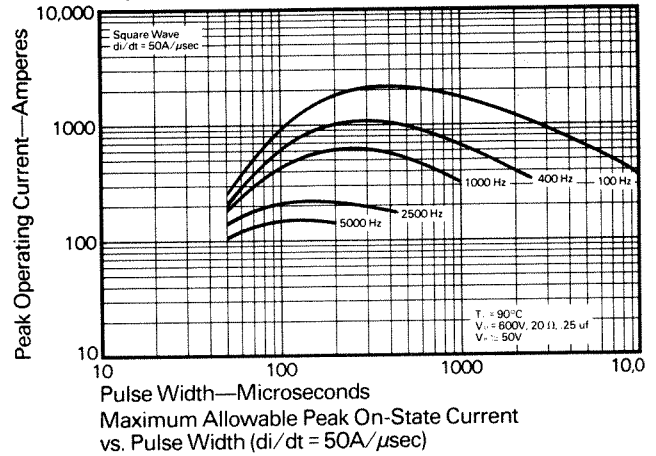

FAST SWITCHING
THYRISTORS