

High Accuracy, Hall-Effect-Based Current Sensor IC in High Isolation SOIC16 Package

FEATURES AND BENEFITS

- Patented integrated digital temperature compensation circuitry allows for near closed loop accuracy over temperature in an open loop sensor
- UL60950-1 (ed. 2) certified
 - Dielectric Strength Voltage = 4.8 kVrms
 - Basic Isolation Working Voltage = 1097 Vrms
 - Reinforced Isolation Working Voltage = 565 Vrms
- Industry-leading noise performance with greatly improved bandwidth through proprietary amplifier and filter design techniques
- Pin-selectable band width: 80 kHz for high bandwidth applications or 20 kHz for low noise performance
- 0.85 mΩ primary conductor resistance for low power loss and high inrush current withstand capability
- Low-profile SOIC16 package suitable for space-constrained applications
- 3 to 3.6 V, single supply operation
- Output voltage proportional to AC or DC current
- Factory-trimmed sensitivity and quiescent output voltage for improved accuracy

Continued on the next page...



PACKAGE: 16-pin SOICW (suffix MA)

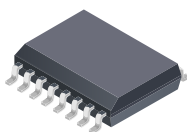

Not to scale

DESCRIPTION

The Allegro™ ACS722 current sensor IC is an economical and precise solution for AC or DC current sensing in industrial, commercial, and communication systems. The small package is ideal for space constrained applications while also saving costs due to reduced board area. Typical applications include motor control, load detection and management, switched-mode power supplies, and overcurrent fault protection.

The device consists of a precise, low-offset, linear Hall sensor circuit with a copper conduction path located near the surface of the die. Applied current flowing through this copper conduction path generates a magnetic field which is sensed by the integrated Hall IC and converted into a proportional voltage. Device accuracy is optimized through the close proximity of the magnetic field to the Hall transducer. A precise, proportional voltage is provided by the low-offset, chopper-stabilized BiCMOS Hall IC, which includes Allegro's patented digital temperature compensation, resulting in extremely accurate performance over temperature. The output of the device has a positive slope when an increasing current flows through the primary copper conduction path (from pins 1 through 4, to pins 5 through 8), which is the path used for current sensing. The internal resistance of this conductive path is 0.85 mΩ typical, providing low power loss.

The terminals of the conductive path are electrically isolated from the sensor leads (pins 9 through 16). This allows the ACS722 current sensor IC to be used in high-side current sense applications without the use of high-side differential amplifiers or other costly isolation techniques.

Continued on the next page...

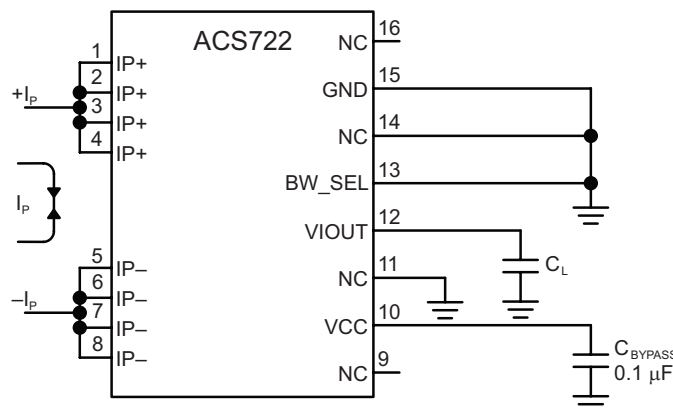

Typical Application

The ACS722 outputs an analog signal, V_{IOUT} , that changes, proportionally, with the bidirectional AC or DC primary sensed current, I_p , within the specified measurement range. The BW_SEL pin can be used to select one of the two bandwidths to optimize the noise performance. Grounding the BW_SEL pin puts the part in the high bandwidth (80 kHz) mode.

FEATURES AND BENEFITS (continued)

- Chopper stabilization results in extremely stable quiescent output voltage
- Nearly zero magnetic hysteresis
- Ratiometric output from supply voltage

DESCRIPTION (continued)

The ACS722 is provided in a low profile surface mount SOIC16 package. The leadframe is plated with 100% matte tin, which is compatible with standard lead (Pb) free printed circuit board assembly processes. Internally, the device is Pb-free, except for flip-chip high-temperature Pb-based solder balls, currently exempt from RoHS. The device is fully calibrated prior to shipment from the factory.

SELECTION GUIDE

Part Number	I_{PR} (A)	Sens(Typ) at $V_{CC} = 3.3$ V (mV/A)	T_A (°C)	Packing [1]
ACS722KMATR-10AB-T	±10	132	-40 to 125	Tape and Reel, 3000 pieces per reel
ACS722KMATR-20AB-T	±20	66		
ACS722KMATR-40AB-T	±40	33		

[1] Contact Allegro for additional packing options.

SPECIFICATIONS

ABSOLUTE MAXIMUM RATINGS

Characteristic	Symbol	Notes	Rating	Units
Supply Voltage	V_{CC}		6	V
Reverse Supply Voltage	V_{RCC}		-0.1	V
Output Voltage	V_{IOUT}		25	V
Reverse Output Voltage	V_{RIOUT}		-0.1	V
Maximum Continuous Current	I_{CMAX}	$T_A = 25^\circ\text{C}$	60	A
Operating Ambient Temperature	T_A	Range K	-40 to 125	$^\circ\text{C}$
Junction Temperature	$T_J(\text{max})$		165	$^\circ\text{C}$
Storage Temperature	T_{stg}		-65 to 165	$^\circ\text{C}$

ISOLATION CHARACTERISTICS

Characteristic	Symbol	Notes	Rating	Unit
Dielectric Strength Test Voltage	V_{ISO}	Agency type-tested for 60 seconds per UL 60950-1 (edition. 2). Production tested at 3000 V_{RMS} for 1 second, in accordance with UL 60950-1 (edition. 2).	4800	V_{RMS}
Working Voltage for Basic Isolation	V_{WVBI}	Maximum approved working voltage for basic (single) isolation according UL 60950-1 (edition 2)	1550	V_{PK}
			1097	V_{RMS} or VDC
Working Voltage for Reinforced Isolation	V_{WVRI}	Maximum approved working voltage for reinforced isolation according to UL 60950-1 (edition 2)	800	V_{PK}
			565	V_{RMS} or VDC
Clearance	D_{cl}	Minimum distance through air from IP leads to signal leads.	7.5	mm
Creepage	D_{cr}	Minimum distance along package body from IP leads to signal leads	8.2	mm

THERMAL CHARACTERISTICS

Characteristic	Symbol	Test Conditions*	Value	Units
Package Thermal Resistance (Junction to Ambient)	$R_{\theta JA}$	Mounted on the Allegro 85-0738 evaluation board with 700 mm ² of 4 oz. copper on each side, connected to pins 1 and 2, and to pins 3 and 4, with thermal vias connecting the layers. Performance values include the power consumed by the PCB.	23	$^\circ\text{C}/\text{W}$
Package Thermal Resistance (Junction to Lead)	$R_{\theta JL}$	Mounted on the Allegro ASEK 722 evaluation board.	5	$^\circ\text{C}/\text{W}$

*Additional thermal information available on the Allegro website.

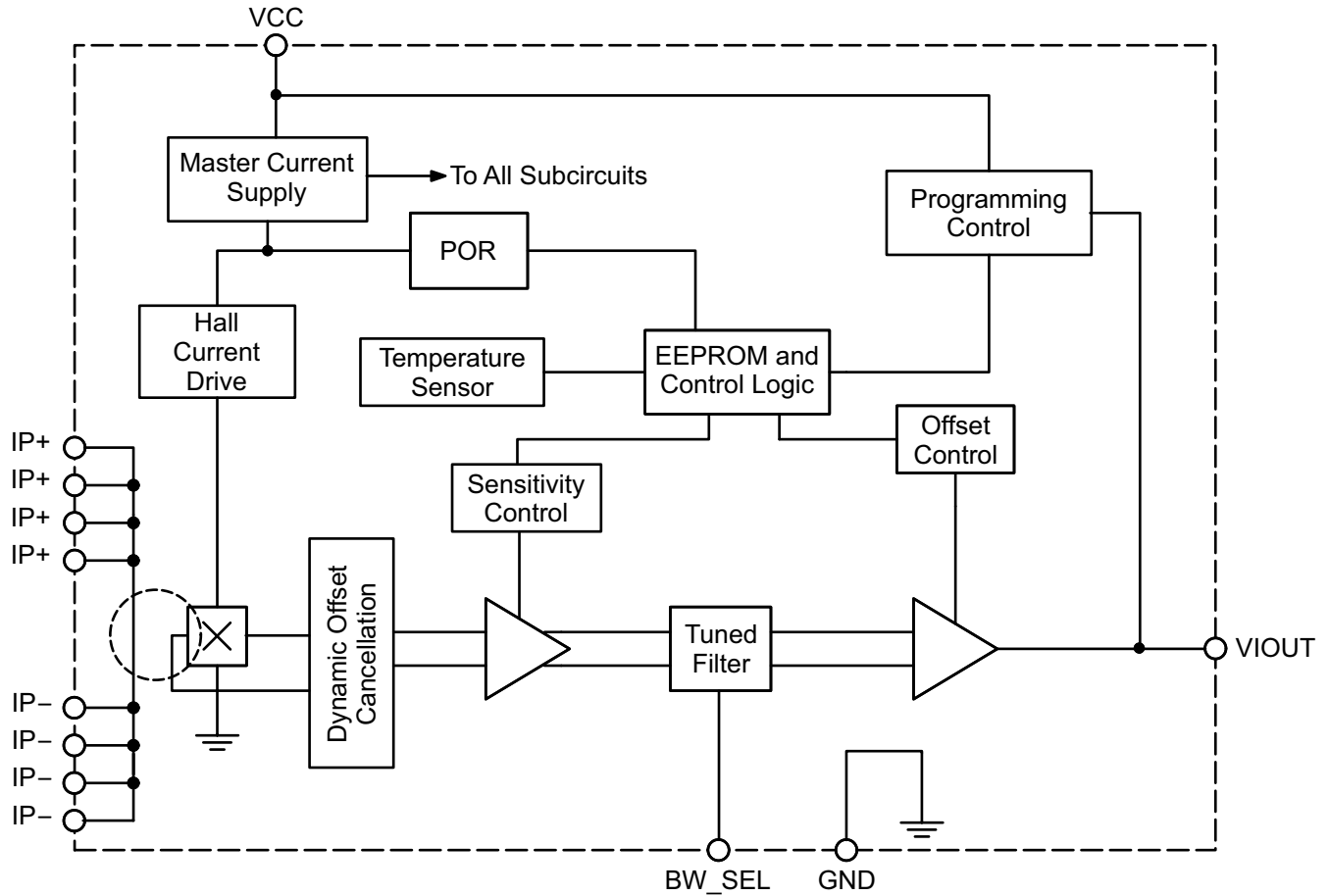

Functional Block Diagram

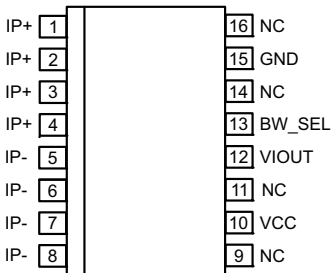

Pinout Diagram

Terminal List Table

Number	Name	Description
1, 2, 3, 4	IP+	Terminals for current being sensed; fused internally
5, 6, 7, 8	IP-	Terminals for current being sensed; fused internally
9, 16	NC	No internal connection; recommended to be left unconnected in order to maintain high creepage.
10	VCC	Device power supply terminal
11, 14	NC	No internal connection; recommended to connect to GND for the best ESD performance
12	VIOUT	Analog output signal
13	BW_SEL	Terminal for selecting 20 kHz or 80 kHz bandwidth
15	GND	Signal ground terminal

**COMMON ELECTRICAL CHARACTERISTICS [1]: Valid through the full range of $T_A = -40^\circ\text{C}$ to 125°C ,
and at $V_{CC} = 3.3\text{ V}$, unless otherwise specified**

Characteristic	Symbol	Test Conditions	Min.	Typ.	Max.	Units
Supply Voltage	V_{CC}		3	3.3	3.6	V
Supply Current	I_{CC}	V_{CC} within $V_{CC}(\text{min})$ and $V_{CC}(\text{max})$	–	9	12	mA
Output Capacitance Load	C_L	VIOUT to GND	–	–	10	nF
Output Resistive Load	R_L	VIOUT to GND	4.7	–	–	k Ω
Primary Conductor Resistance	R_{IP}	$T_A = 25^\circ\text{C}$	–	0.85	–	m Ω
Magnetic Coupling Factor	C_F		–	4.5	–	G/A
Rise Time	t_r	$I_P = I_P(\text{max})$, $T_A = 25^\circ\text{C}$, $C_L = 1\text{ nF}$, BW_SEL tied to GND	–	4	–	μs
		$I_P = I_P(\text{max})$, $T_A = 25^\circ\text{C}$, $C_L = 1\text{ nF}$, BW_SEL tied to VCC	–	17.5	–	μs
Propagation Delay	t_{pd}	$I_P = I_P(\text{max})$, $T_A = 25^\circ\text{C}$, $C_L = 1\text{ nF}$, BW_SEL tied to GND	–	2	–	μs
		$I_P = I_P(\text{max})$, $T_A = 25^\circ\text{C}$, $C_L = 1\text{ nF}$, BW_SEL tied to VCC	–	5	–	μs
Response Time	t_{RESPONSE}	$I_P = I_P(\text{max})$, $T_A = 25^\circ\text{C}$, $C_L = 1\text{ nF}$, BW_SEL tied to GND	–	5	–	μs
		$I_P = I_P(\text{max})$, $T_A = 25^\circ\text{C}$, $C_L = 1\text{ nF}$, BW_SEL tied to VCC	–	22.5	–	μs
Internal Bandwidth	BW _i	Small signal –3 dB; $C_L = 1\text{ nF}$, BW_SEL tied to GND	–	80	–	kHz
		Small signal –3 dB; $C_L = 1\text{ nF}$, BW_SEL tied to VCC	–	20	–	kHz
Noise Density	I_{ND}	Input referenced noise density; $T_A = 25^\circ\text{C}$, $C_L = 1\text{ nF}$	–	300	–	$\mu\text{A}_{(\text{rms})}/\sqrt{\text{Hz}}$
Noise	I_N	Input referenced noise; BW _i = 80 kHz, $T_A = 25^\circ\text{C}$, $C_L = 1\text{ nF}$	–	84	–	$\text{mA}_{(\text{rms})}$
		Input referenced noise; BW _i = 20 kHz, $T_A = 25^\circ\text{C}$, $C_L = 1\text{ nF}$	–	42	–	$\text{mA}_{(\text{rms})}$
Nonlinearity	E_{LIN}	Through full range of I_P	–	± 1	–	%
Saturation Voltage [2]	V_{OH}	$R_L = 4.7\text{ k}\Omega$, $T_A = 25^\circ\text{C}$	$V_{CC} - 0.33$	–	–	V
	V_{OL}	$R_L = 4.7\text{ k}\Omega$, $T_A = 25^\circ\text{C}$	–	–	0.33	V
Power-On Time	t_{PO}	Output reaches 90% of steady-state level, $T_A = 25^\circ\text{C}$, $I_P = I_{PR}(\text{max})$ applied	–	64	–	μs

[1] Device may be operated at higher primary current levels, I_P , ambient temperatures, T_A , and internal leadframe temperatures, provided the Maximum Junction Temperature, $T_J(\text{max})$, is not exceeded.

[2] The sensor IC will continue to respond to current beyond the range of I_P until the high or low saturation voltage; however, the nonlinearity in this region will be worse than through the rest of the measurement range.

xKMATR-10AB PERFORMANCE CHARACTERISTICS: T_A Range K, valid at $T_A = -40^\circ\text{C}$ to 125°C , $V_{CC} = 3.3\text{ V}$, unless otherwise specified

Characteristic	Symbol	Test Conditions	Min.	Typ. ^[1]	Max.	Units
NOMINAL PERFORMANCE						
Current Sensing Range	I_{PR}		-10	-	10	A
Sensitivity	Sens	$I_{PR(\min)} < I_P < I_{PR(\max)}$	-	132	-	mV/A
Zero Current Output Voltage	$V_{IOUT(Q)}$	Bidirectional; $I_P = 0\text{ A}$	-	$V_{CC} \times 0.5$	-	V
ACCURACY PERFORMANCE						
Total Output Error ^[2]	E_{TOT}	$I_P = I_{PR(\max)}$, $T_A = 25^\circ\text{C}$ to 125°C	-2.5	± 1.7	2.5	%
		$I_P = I_{PR(\max)}$, $T_A = -40^\circ\text{C}$ to 25°C	-	± 2.5	-	%
TOTAL OUTPUT ERROR COMPONENTS ^[3]: $E_{TOT} = E_{SENS} + 100 \times V_{OE} / (\text{Sens} \times I_P)$						
Sensitivity Error	E_{SENS}	$T_A = 25^\circ\text{C}$ to 125°C ; measured at $I_P = I_{PR(\max)}$	-2	± 1.5	2	%
		$T_A = -40^\circ\text{C}$ to 25°C ; ; measured at $I_P = I_{PR(\max)}$	-	± 2.3	-	%
Offset Voltage ^[4]	V_{OE}	$I_P = 0\text{ A}$; $T_A = 25^\circ\text{C}$ to 125°C	-15	± 7	15	mV
		$I_P = 0\text{ A}$; $T_A = -40^\circ\text{C}$ to 25°C	-	± 20	-	mV
LIFETIME DRIFT CHARACTERISTICS						
Sensitivity Error Lifetime Drift	$E_{\text{sens_drift}}$		-	± 1	-	%
Total Output Error Lifetime Drift	$E_{\text{tot_drift}}$		-	± 1	-	%

^[1] Typical values with +/- are 3 sigma values.

^[2] Percentage of I_P , with $I_P = I_{PR(\max)}$

^[3] A single part will not have both the maximum/minimum sensitivity error and maximum/minimum offset voltage, as that would violate the maximum/minimum total output error specification. Also, 3 sigma distribution values are combined by taking the square root of the sum of the squares. See Application Information section.

^[4] Offset Voltage does not incorporate any error due to external magnetic fields. See section: Impact of External Magnetic Fields.

xKMATR-20AB PERFORMANCE CHARACTERISTICS: T_A Range K, valid at $T_A = -40^\circ\text{C}$ to 125°C , $V_{CC} = 3.3\text{ V}$, unless otherwise specified

Characteristic	Symbol	Test Conditions	Min.	Typ. ^[1]	Max.	Units
NOMINAL PERFORMANCE						
Current Sensing Range	I_{PR}		-20	-	20	A
Sensitivity	Sens	$I_{PR(\min)} < I_P < I_{PR(\max)}$	-	66	-	mV/A
Zero Current Output Voltage	$V_{IOUT(Q)}$	Bidirectional; $I_P = 0\text{ A}$	-	$V_{CC} \times 0.5$	-	V
ACCURACY PERFORMANCE						
Total Output Error ^[2]	E_{TOT}	$I_P = I_{PR(\max)}$, $T_A = 25^\circ\text{C}$ to 125°C	-2	± 1.2	2	%
		$I_P = I_{PR(\max)}$, $T_A = -40^\circ\text{C}$ to 25°C	-	± 2.1	-	%
TOTAL OUTPUT ERROR COMPONENTS ^[3]: $E_{TOT} = E_{SENS} + 100 \times V_{OE} / (\text{Sens} \times I_P)$						
Sensitivity Error	E_{SENS}	$T_A = 25^\circ\text{C}$ to 125°C ; measured at $I_P = I_{PR(\max)}$	-1.5	± 0.75	1.5	%
		$T_A = -40^\circ\text{C}$ to 25°C ; ; measured at $I_P = I_{PR(\max)}$	-	± 1.25	-	%
Offset Voltage ^[4]	V_{OE}	$I_P = 0\text{ A}$; $T_A = 25^\circ\text{C}$ to 125°C	-10	± 4.5	10	mV
		$I_P = 0\text{ A}$; $T_A = -40^\circ\text{C}$ to 25°C	-	± 10	-	mV
LIFETIME DRIFT CHARACTERISTICS						
Sensitivity Error Lifetime Drift	$E_{\text{sens_drift}}$		-	± 1	-	%
Total Output Error Lifetime Drift	$E_{\text{tot_drift}}$		-	± 1	-	%

^[1] Typical values with +/- are 3 sigma values.

^[2] Percentage of I_P , with $I_P = I_{PR(\max)}$

^[3] A single part will not have both the maximum/minimum sensitivity error and maximum/minimum offset voltage, as that would violate the maximum/minimum total output error specification. Also, 3 sigma distribution values are combined by taking the square root of the sum of the squares. See Application Information section.

^[4] Offset Voltage does not incorporate any error due to external magnetic fields. See section: Impact of External Magnetic Fields.

xKMATR-40AB PERFORMANCE CHARACTERISTICS: T_A Range K, valid at $T_A = -40^\circ\text{C}$ to 125°C , $V_{CC} = 3.3\text{ V}$, unless otherwise specified

Characteristic	Symbol	Test Conditions	Min.	Typ. [1]	Max.	Units
NOMINAL PERFORMANCE						
Current Sensing Range	I_{PR}		-40	-	40	A
Sensitivity	Sens	$I_{PR(\min)} < I_P < I_{PR(\max)}$	-	33	-	mV/A
Zero Current Output Voltage	$V_{IOUT(Q)}$	Bidirectional; $I_P = 0\text{ A}$	-	$V_{CC} \times 0.5$	-	V
ACCURACY PERFORMANCE						
Total Output Error [2]	E_{TOT}	$I_P = I_{PR(\max)}$, $T_A = 25^\circ\text{C}$ to 125°C	-2	± 1.25	2	%
		$I_P = I_{PR(\max)}$, $T_A = -40^\circ\text{C}$ to 25°C	-	± 2	-	%
TOTAL OUTPUT ERROR COMPONENTS [3]: $E_{TOT} = E_{SENS} + 100 \times V_{OE} / (\text{Sens} \times I_P)$						
Sensitivity Error	E_{SENS}	$T_A = 25^\circ\text{C}$ to 125°C ; measured at $I_P = I_{PR(\max)}$	-1.5	± 1.2	1.5	%
		$T_A = -40^\circ\text{C}$ to 25°C ; ; measured at $I_P = I_{PR(\max)}$	-	± 1.75	-	%
Offset Voltage [4]	V_{OE}	$I_P = 0\text{ A}$; $T_A = 25^\circ\text{C}$ to 125°C	-10	± 3	10	mV
		$I_P = 0\text{ A}$; $T_A = -40^\circ\text{C}$ to 25°C	-	± 5	-	mV
LIFETIME DRIFT CHARACTERISTICS						
Sensitivity Error Lifetime Drift	$E_{\text{sens_drift}}$		-	± 1	-	%
Total Output Error Lifetime Drift	$E_{\text{tot_drift}}$		-	± 1	-	%

[1] Typical values with +/- are 3 sigma values.

[2] Percentage of I_P , with $I_P = I_{PR(\max)}$

[3] A single part will not have both the maximum/minimum sensitivity error and maximum/minimum offset voltage, as that would violate the maximum/minimum total output error specification. Also, 3 sigma distribution values are combined by taking the square root of the sum of the squares. See Application Information section.

[4] Offset Voltage does not incorporate any error due to external magnetic fields. See section: Impact of External Magnetic Fields.

CHARACTERISTIC PERFORMANCE

xKMATR-10AB Key Parameters

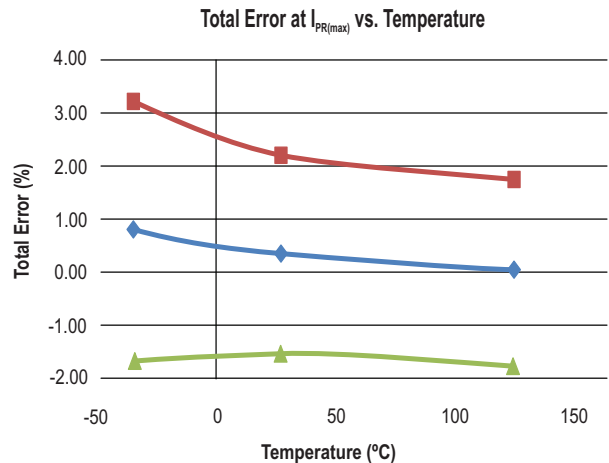
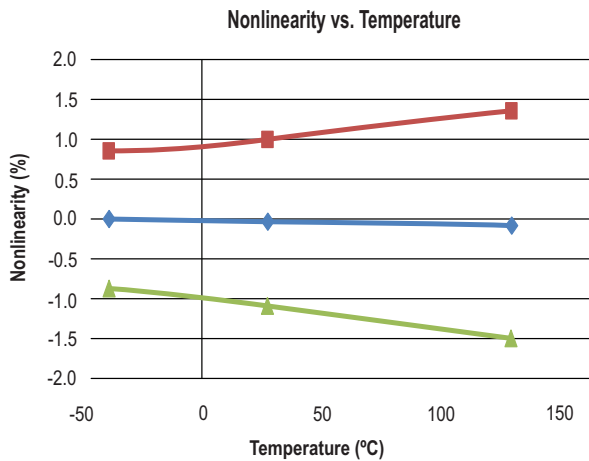
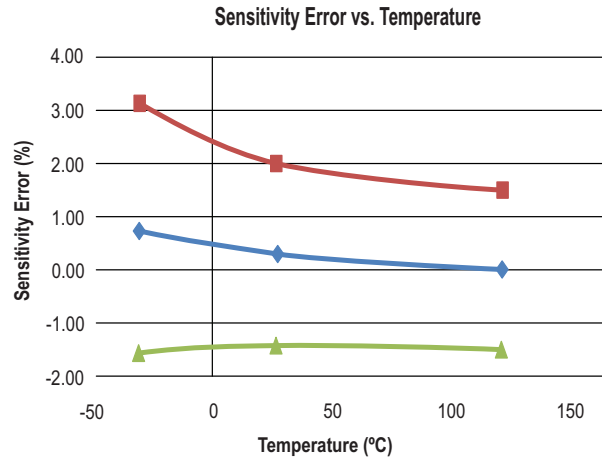
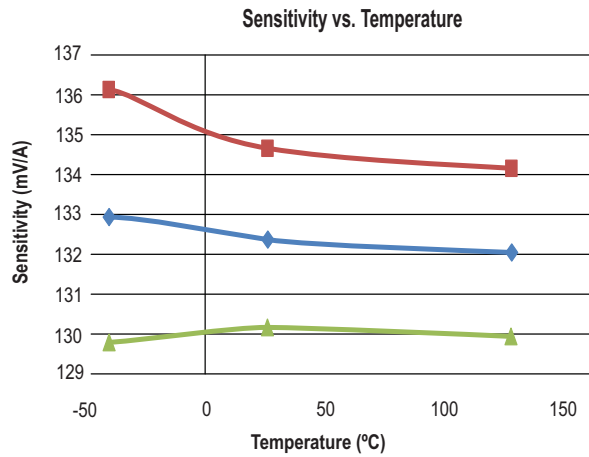
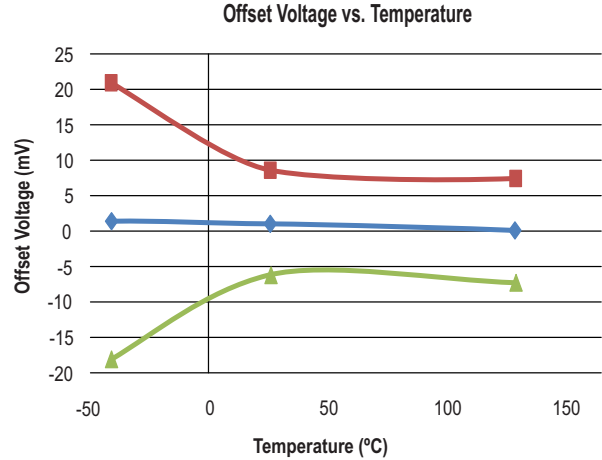
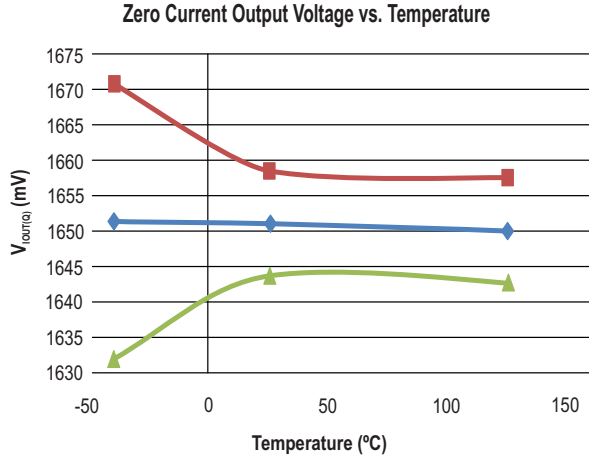

■ +3 Sigma
 ◆ Average
 ▲ -3 Sigma

xKMATR-20AB Key Parameters

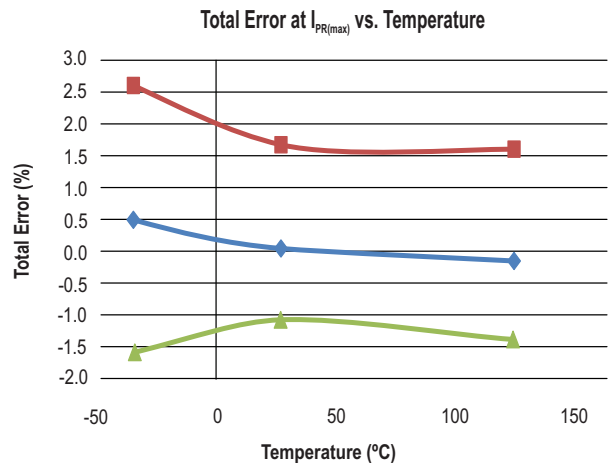
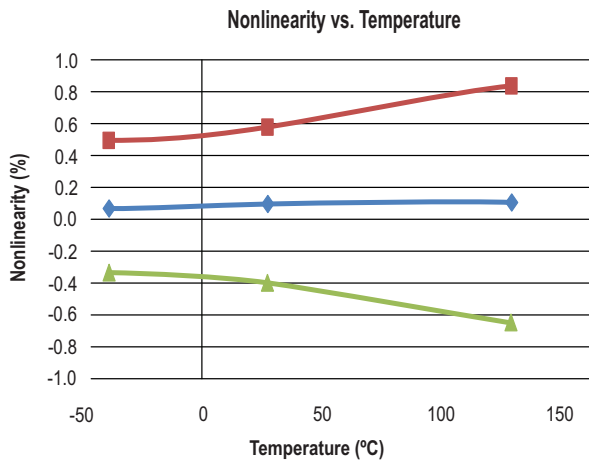
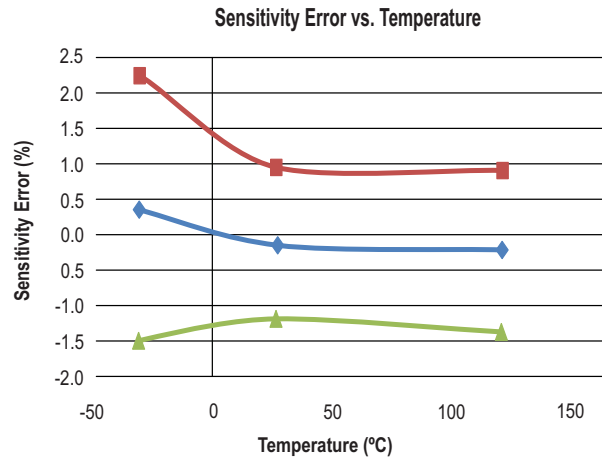
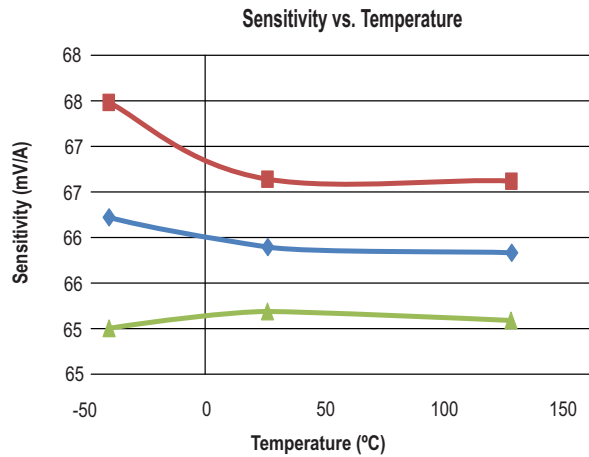
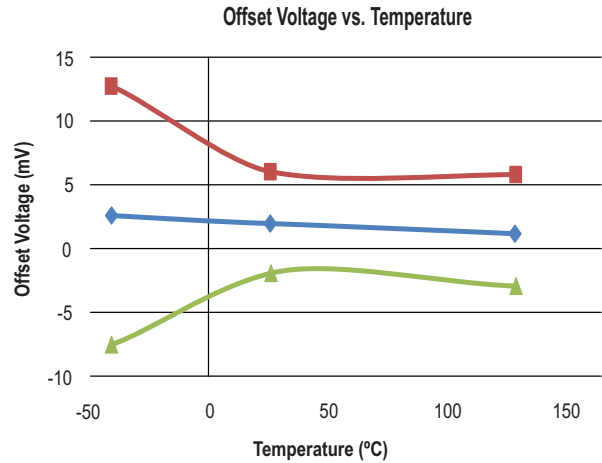
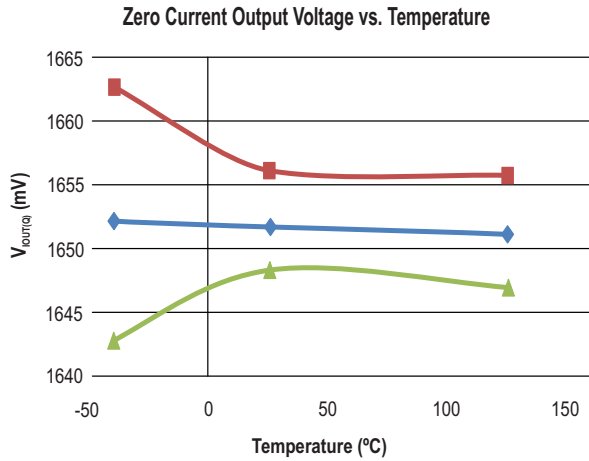

■ +3 Sigma
 ◆ Average
 ▲ -3 Sigma

xKMATR-40AB Key Parameters

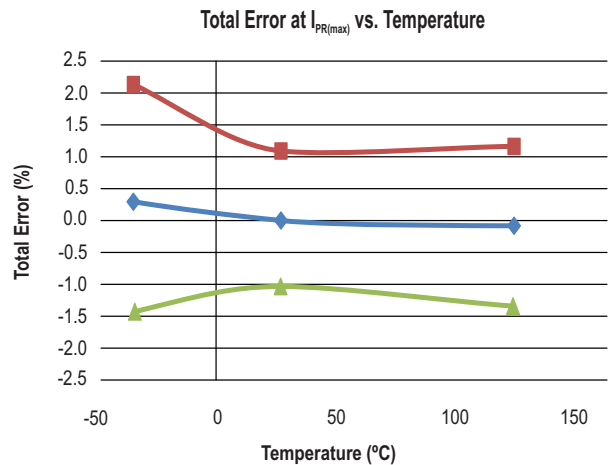
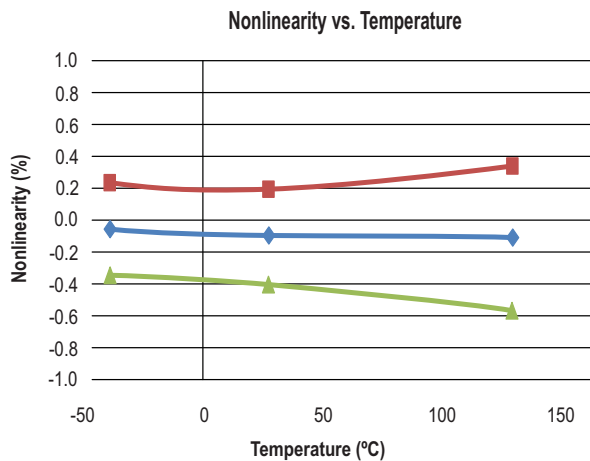
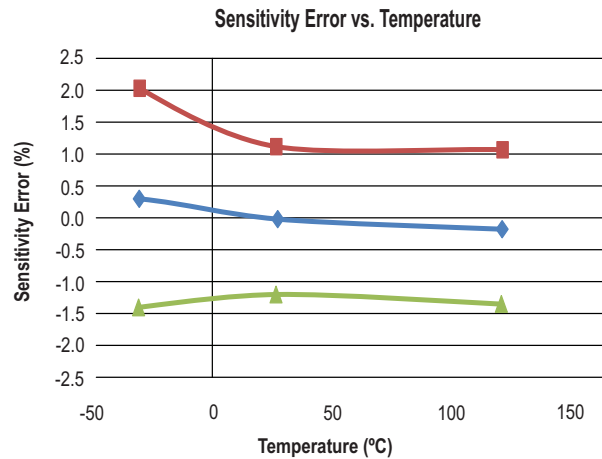
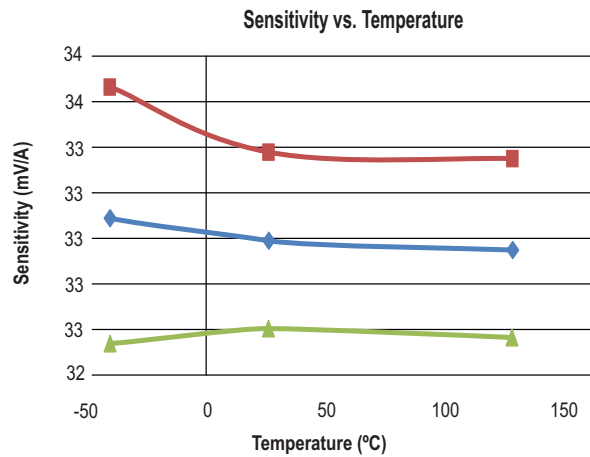
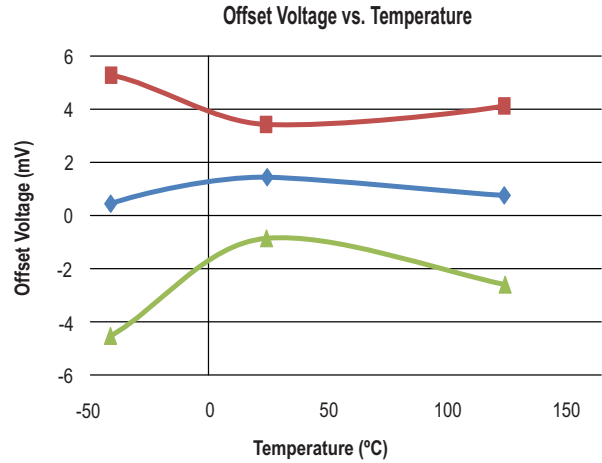
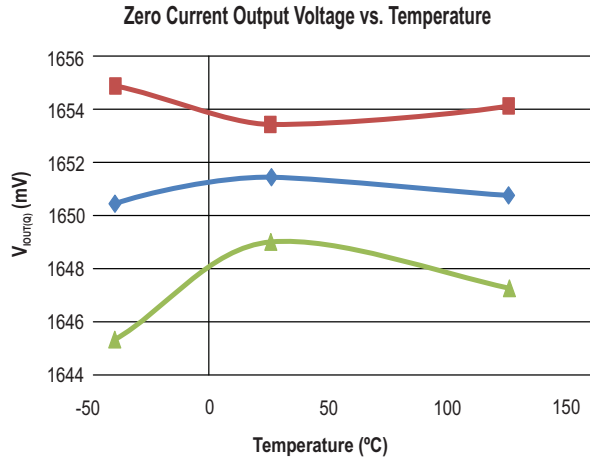

■ +3 Sigma
 ◆ Average
 ▲ -3 Sigma

DEFINITIONS OF ACCURACY CHARACTERISTICS

Sensitivity (Sens)

The change in sensor IC output in response to a 1A change through the primary conductor. The sensitivity is the product of the magnetic coupling factor (G/A) (1 G = 0.1 mT) and the linear IC amplifier gain (mV/G). The linear IC amplifier gain is programmed at the factory to optimize the sensitivity (mV/A) for the full-scale current of the device.

Nonlinearity (E_{LIN})

The nonlinearity is a measure of how linear the output of the sensor IC is over the full current measurement range. The nonlinearity is calculated as:

$$E_{LIN} = \left\{ 1 - \left[\frac{V_{IOUT}(I_{PR(max)}) - V_{IOUT(Q)}}{2 \times V_{IOUT}(I_{PR(max)}/2) - V_{IOUT(Q)}} \right] \right\} \times 100 (\%)$$

where $V_{IOUT}(I_{PR(max)})$ is the output of the sensor IC with the maximum measurement current flowing through it and $V_{IOUT}(I_{PR(max)}/2)$ is the output of the sensor IC with half of the maximum measurement current flowing through it.

Zero Current Output Voltage ($V_{IOUT(Q)}$)

The output of the sensor when the primary current is zero. For a unipolar supply voltage, it nominally remains at $0.5 \times V_{CC}$ for a bidirectional device and $0.1 \times V_{CC}$ for a unidirectional device. For example, in the case of a bidirectional output device, $V_{CC} = 3.3 \text{ V}$ translates into $V_{IOUT(Q)} = 1.65 \text{ V}$. Variation in $V_{IOUT(Q)}$ can be attributed to the resolution of the Allegro linear IC quiescent voltage trim and thermal drift.

Offset Voltage (V_{OE})

The deviation of the device output from its ideal quiescent value of $0.5 \times V_{CC}$ (bidirectional) or $0.1 \times V_{CC}$ (unidirectional) due to nonmagnetic causes. To convert this voltage to amperes, divide by the device sensitivity, Sens.

Total Output Error (E_{TOT})

The the difference between the current measurement from the sensor IC and the actual current (I_P), relative to the actual current. This is equivalent to the difference between the ideal output voltage and the actual output voltage, divided by the ideal sensitivity, relative to the current flowing through the primary conduction path:

$$E_{TOT}(I_P) = \frac{V_{IOUT_ideal}(I_P) - V_{IOUT}(I_P)}{\text{Sens}_{ideal}(I_P) \times I_P} \times 100 (\%)$$

The Total Output Error incorporates all sources of error and is a function of I_P . At relatively high currents, E_{TOT} will be mostly

due to sensitivity error, and at relatively low currents, E_{TOT} will be mostly due to Offset Voltage (V_{OE}). In fact, at $I_P = 0$, E_{TOT} approaches infinity due to the offset. This is illustrated in Figures 1 and 2. Figure 1 shows a distribution of output voltages versus I_P at 25°C and across temperature. Figure 2 shows the corresponding E_{TOT} versus I_P .

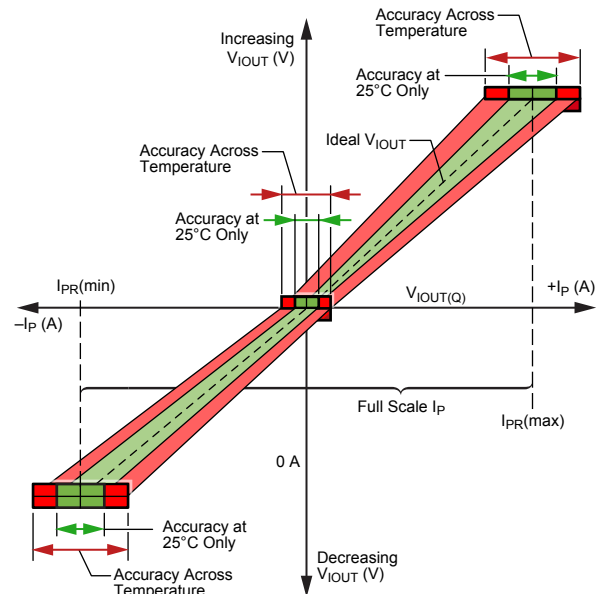

Figure 1: Output Voltage versus Sensed Current

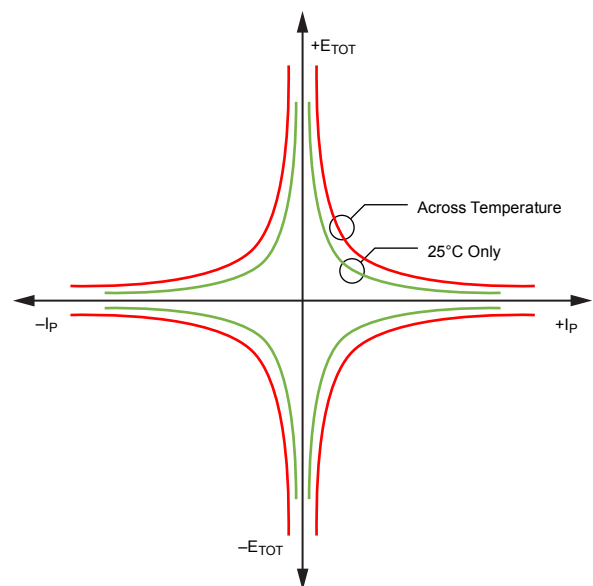

Figure 2: Total Output Error versus Sensed Current

APPLICATION INFORMATION

Impact of External Magnetic Fields

The ACS722 works by sensing the magnetic field created by the current flowing through the package. However, the sensor cannot differentiate between fields created by the current flow and external magnetic fields. This means that external magnetic fields can cause errors in the output of the sensor. Magnetic fields which are perpendicular to the surface of the package affect the output of the sensor, as it only senses fields in that one plane. The error in Amperes can be quantified as:

$$Error(B) = \frac{B}{C_F}$$

where B is the strength of the external field perpendicular to the surface of the package in Gauss, and C_F is the coupling factor in G/A. Then, multiplying by the sensitivity of the part (Sens) gives the error in mV.

For example, an external field of 1 Gauss will result in around 0.22 A of error. If the ACS722KMATR-10AB, which has a nominal sensitivity of 132 mV/A, is being used, that equates to 29 mV of error on the output of the sensor.

Table 1: External Magnetic Field (Gauss) Impact

External Field (Gauss)	Error (A)	Error (mV)		
		10AB	20AB	40AB
0.5	0.11	15	7	4
1	0.22	29	15	7
2	0.44	58	29	15

Estimating Total Error vs. Sensed Current

The Performance Characteristics tables give distribution (± 3 sigma) values for Total Error at $I_{PR(max)}$; however, one often wants to know what error to expect at a particular current. This can be estimated by using the distribution data for the components of Total Error, Sensitivity Error and Offset Voltage. The

± 3 sigma value for Total Error (E_{TOT}) as a function of the sensed current (I_P) is estimated as:

$$E_{TOT}(I_P) = \sqrt{E_{SENS}^2 + \left(\frac{100 \times V_{OE}}{Sens \times I_P}\right)^2}$$

Here, E_{SENS} and V_{OE} are the ± 3 sigma values for those error terms. If there is an average sensitivity error or average offset voltage, then the average Total Error is estimated as:

$$E_{TOT_{AVG}}(I_P) = E_{SENS_{AVG}} + \frac{100 \times V_{OE_{AVG}}}{Sens \times I_P}$$

The resulting total error will be a sum of E_{TOT} and $E_{TOT_{AVG}}$. Using these equations and the 3 sigma distributions for Sensitivity Error and Offset Voltage, the Total Error vs. sensed current (I_P) is below for the ACS722KMATR-40AB. As expected, as one goes towards zero current, the error in percent goes towards infinity due to division by zero (refer to Figure 3)

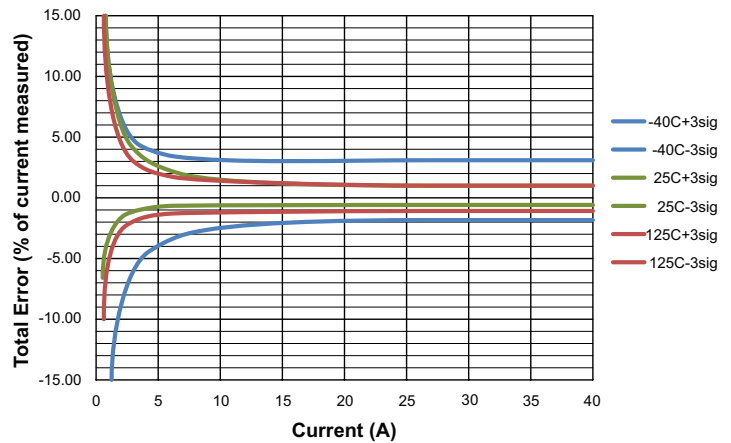

Figure 3: Predicted Total Error as a Function of Sensed Current for the ACS722KMATR-40AB

Thermal Rise vs. Primary Current

Self-heating due to the flow of current should be considered during the design of any current sensing system. The sensor, printed circuit board (PCB), and contacts to the PCB will generate heat as current moves through the system.

The thermal response is highly dependent on PCB layout, copper thickness, cooling techniques, and the profile of the injected current. The current profile includes peak current, current “on-time”, and duty cycle. While the data presented in this section was collected with direct current (DC), these numbers may be used to approximate thermal response for both AC signals and current pulses.

The plot in Figure 4 shows the measured rise in steady-state die temperature of the ACS722 versus continuous current at an ambient temperature, T_A , of 25 °C. The thermal offset curves may be directly applied to other values of T_A . Conversely, Figure 5 shows the maximum continuous current at a given T_A . Surges beyond the maximum current listed in Figure 5 are allowed given the maximum junction temperature, $T_{J(MAX)}$ (165°C), is not exceeded.

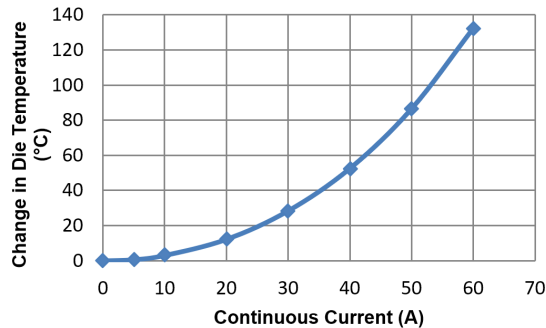

Figure 4: Self-Heating in the MA Package Due to Current Flow

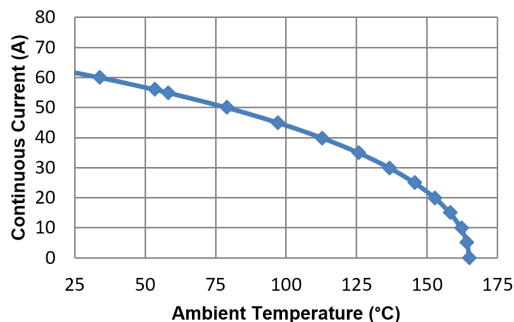

Figure 5: Maximum Continuous Current at a Given T_A

The thermal capacity of the ACS722 should be verified by the end user in the application’s specific conditions. The maximum junction temperature, $T_{J(MAX)}$ (165°C), should not be exceeded. Further information on this application testing is available in the [DC and Transient Current Capability application note](#) on the Allegro website.

ASEK722 Evaluation Board Layout

Thermal data shown in Figure 4 and Figure 5 was collected using the ASEK722 Evaluation Board (TED-85-0738-003). This board includes 1280 mm² of 4 oz. copper (0.1388) connected to pins 1 through 4, and to pins 5 through 8, with thermal vias connecting the layers. Top and Bottom layers of the PCB are shown below in Figure 6.

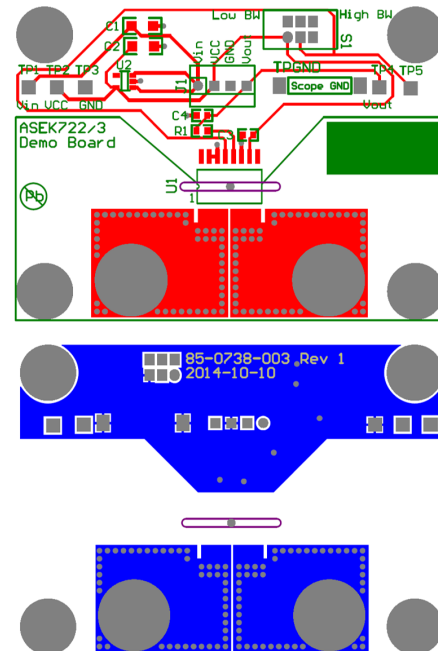

Figure 6: Top and Bottom Layers for ASEK722 Evaluation Board

Gerber files for the ASEK722 evaluation board are available for download from the Allegro website. See the technical documents section of the [ACS722 device webpage](#).

DEFINITIONS OF DYNAMIC RESPONSE CHARACTERISTICS

Power-On Time (t_{PO})

When the supply is ramped to its operating voltage, the device requires a finite time to power its internal components before responding to an input magnetic field.

Power-On Time (t_{PO}) is defined as the time it takes for the output voltage to settle within $\pm 10\%$ of its steady state value under an applied magnetic field, after the power supply has reached its minimum specified operating voltage ($V_{CC(min)}$) as shown in the chart at right (refer to Figure 7).

Rise Time (t_r)

The time interval between: a) when the sensor IC reaches 10% of its full scale value; and b) when it reaches 90% of its full scale value (refer to Figure 8). The rise time to a step response is used to derive the bandwidth of the current sensor IC, in which $f(-3 \text{ dB}) = 0.35/t_r$. Both t_r and $t_{RESPONSE}$ are detrimentally affected by eddy current losses observed in the conductive IC ground plane.

Propagation Delay (t_{pd})

The propagation delay is measured as the time interval between: a) when the primary current signal reaches 20% of its final value; and b) when the device reaches 20% of its output corresponding to the applied current (refer to Figure 8).

Response Time ($t_{RESPONSE}$)

The time interval between: a) when the primary current signal reaches 90% of its final value; and b) when the device reaches 90% of its output corresponding to the applied current (refer to Figure 9).

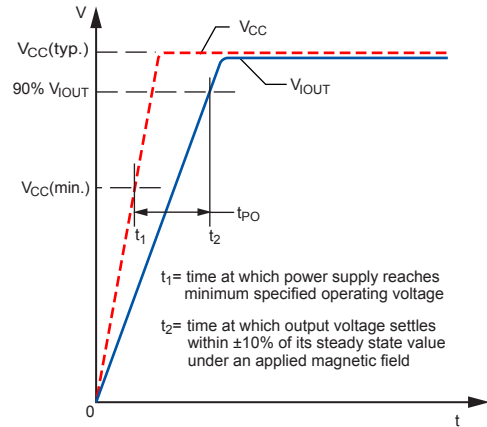

Figure 7: Power-On Time

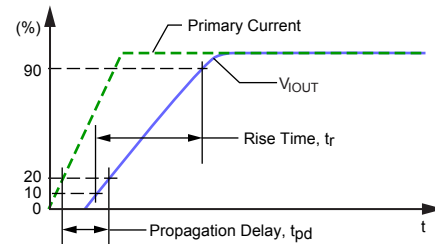

Figure 8: Rise Time and Propagation Delay

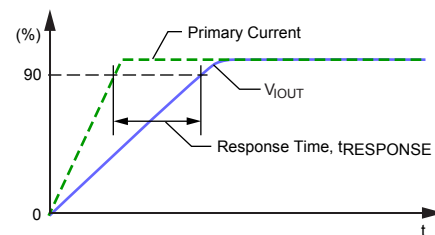

Figure 9: Response Time

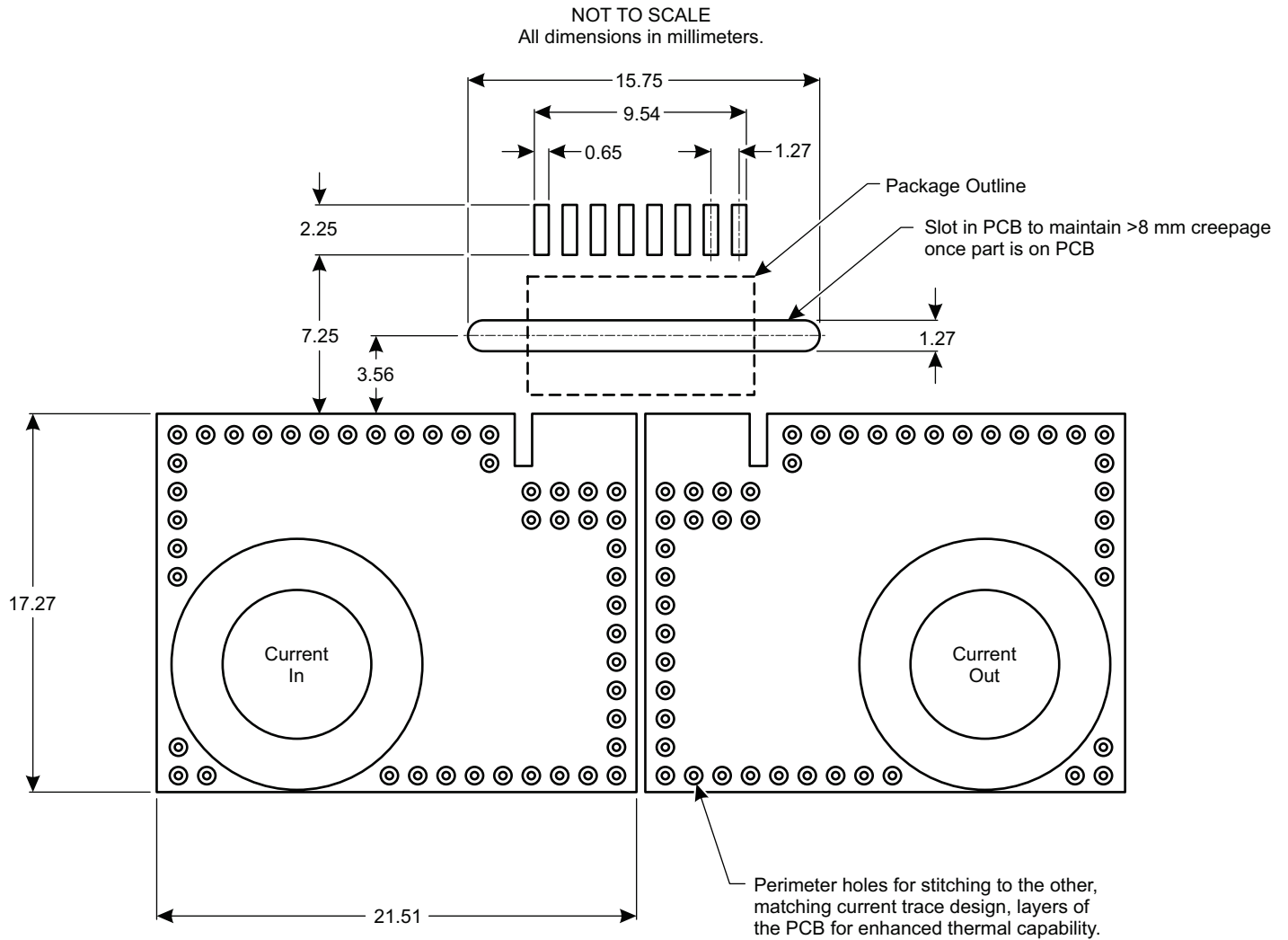

Figure 10: High-Isolation PCB Layout

PACKAGE OUTLINE DRAWING

For Reference Only – Not for Tooling Use

(Reference MS-013AA)

NOT TO SCALE

Dimensions in millimeters

Dimensions exclusive of mold flash, gate burrs, and dambar protrusions

Exact case and lead configuration at supplier discretion within limits shown

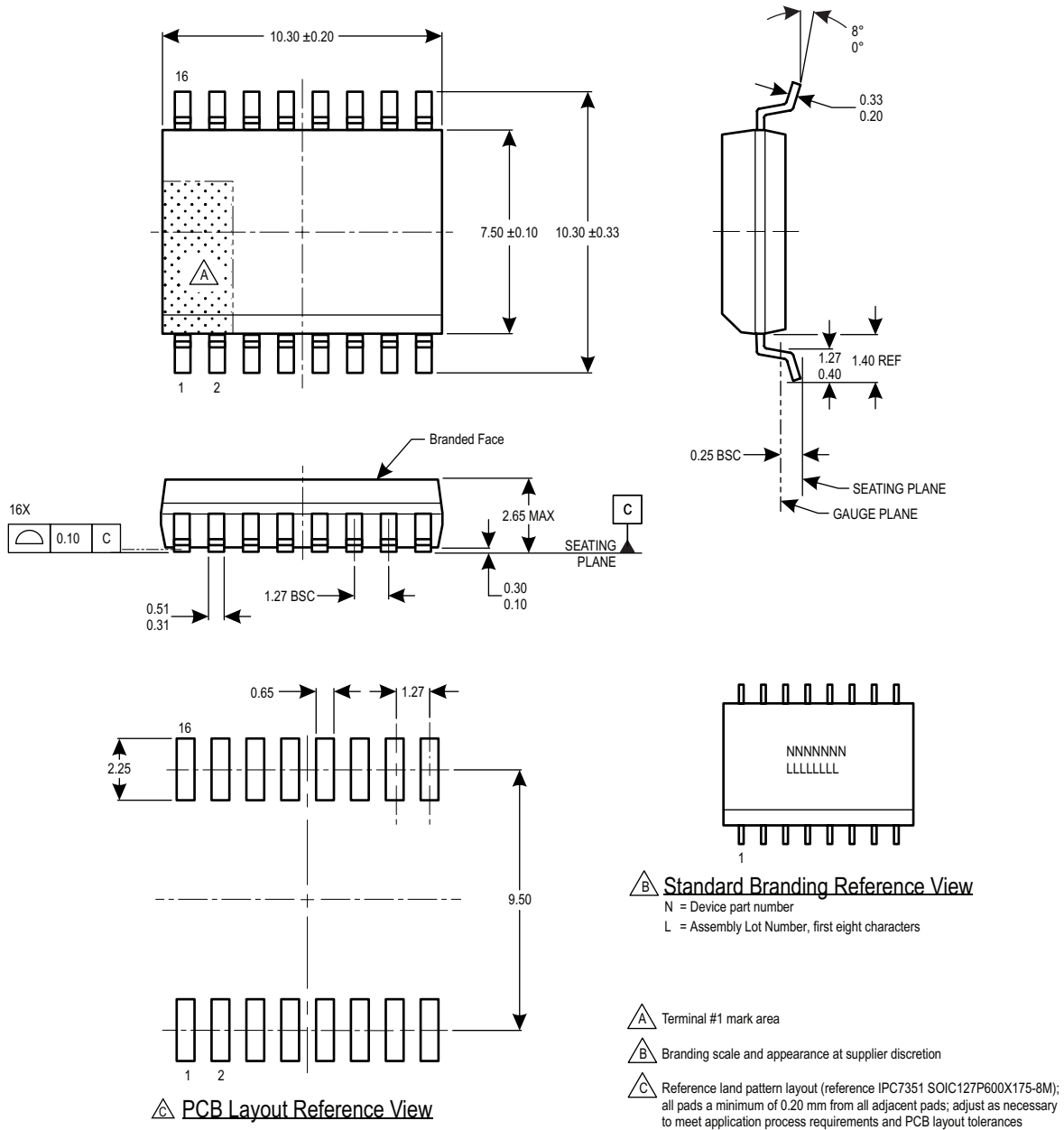

Figure 11: Package MA, 16-pin SOICW

REVISION HISTORY

Number	Date	Description
–	March 4, 2015	Initial release
1	April 13, 2016	Corrected Package Outline Drawing branding information (page 16).
2	December 14, 2018	Updated certificate numbers and minor editorial updates
3	May 3, 2019	Updated TUV certificate mark
4	September 9, 2019	Added Maximum Continuous Current to Absolute Maximum Ratings table (page 3) and thermal data section (page 14)

Copyright 2019, Allegro MicroSystems.

Allegro MicroSystems reserves the right to make, from time to time, such departures from the detail specifications as may be required to permit improvements in the performance, reliability, or manufacturability of its products. Before placing an order, the user is cautioned to verify that the information being relied upon is current.

Allegro's products are not to be used in any devices or systems, including but not limited to life support devices or systems, in which a failure of Allegro's product can reasonably be expected to cause bodily harm.

The information included herein is believed to be accurate and reliable. However, Allegro MicroSystems assumes no responsibility for its use; nor for any infringement of patents or other rights of third parties which may result from its use.

Copies of this document are considered uncontrolled documents.

For the latest version of this document, visit our website:

www.allegromicro.com