

### NPN Silicon AF Transistor Array

- For AF stages and driver applications
- High current gain
- Low collector-emitter saturation voltage
- Two (galvanic) internal isolated NPN/PNP transistors in one package
- Pb-free (RoHS compliant) package
- Qualified according AEC Q101

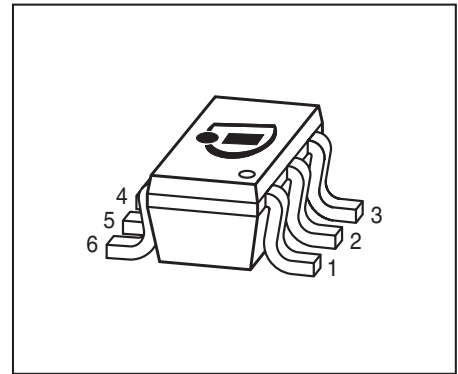

### Tape loading orientation

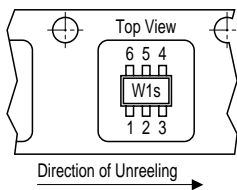

Marking on SC74 package (for example W1s) corresponds to pin 1 of device

Position in tape: pin 1 opposite of feed hole side

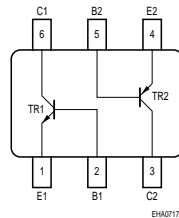

SC74\_Tape

Type	Marking	Pin Configuration						Package
BC817UPN	1Bs	1=E1	2=B1	3=C2	4=E2	5=B2	6=C1	SC74

### Maximum Ratings

Parameter	Symbol	Value	Unit
Collector-emitter voltage	$V_{CEO}$	45	V
Collector-base voltage	$V_{CBO}$	50	
Emitter-base voltage	$V_{EBO}$	5	
Collector current	$I_C$	500	mA
Peak collector current, $t_p \leq 10$ ms	$I_{CM}$	1000	
Base current	$I_B$	100	
Peak base current	$I_{BM}$	200	mW
Total power dissipation- $T_S \leq 115$ °C	$P_{tot}$	330	
Junction temperature	$T_j$	150	
Storage temperature	$T_{stg}$	-65 ... 150	

**Thermal Resistance**

Parameter	Symbol	Value	Unit
Junction - soldering point <sup>1)</sup>	$R_{thJS}$	$\leq 105$	K/W

**Electrical Characteristics at  $T_A = 25^\circ\text{C}$ , unless otherwise specified**

Parameter	Symbol	Values			Unit
		min.	typ.	max.	

**DC Characteristics**

Collector-emitter breakdown voltage $I_C = 10 \text{ mA}, I_B = 0$	$V_{(BR)CEO}$	45	-	-	V
Collector-base breakdown voltage $I_C = 10 \mu\text{A}, I_E = 0$	$V_{(BR)CBO}$	50	-	-	
Emitter-base breakdown voltage $I_E = 10 \mu\text{A}, I_C = 0$	$V_{(BR)EBO}$	5	-	-	
Collector-base cutoff current $V_{CB} = 25 \text{ V}, I_E = 0$ $V_{CB} = 25 \text{ V}, I_E = 0, T_A = 150^\circ\text{C}$	$I_{CBO}$	-	-	0.1 50	$\mu\text{A}$
Emitter-base cutoff current $V_{EB} = 4 \text{ V}, I_C = 0$	$I_{EBO}$	-	-	100	nA
DC current gain <sup>2)</sup> $I_C = 100 \text{ mA}, V_{CE} = 1 \text{ V}$ $I_C = 300 \text{ mA}, V_{CE} = 1 \text{ V}$	$h_{FE}$	160 100	250 -	400 -	-
Collector-emitter saturation voltage <sup>2)</sup> $I_C = 500 \text{ mA}, I_B = 50 \text{ mA}$	$V_{CEsat}$	-	-	0.7	V
Base emitter saturation voltage <sup>2)</sup> $I_C = 500 \text{ mA}, I_B = 50 \text{ mA}$	$V_{BEsat}$	-	-	1.2	

**AC Characteristics**

Transition frequency $I_C = 50 \text{ mA}, V_{CE} = 5 \text{ V}, f = 100 \text{ MHz}$	$f_T$	-	170	-	MHz
Collector-base capacitance $f = 1 \text{ MHz}, V_{BE} = 10 \text{ V}$	$C_{cb}$	-	6	-	pF
Emitter-base capacitance $V_{EB} = 0.5 \text{ V}, f = 1 \text{ MHz}$	$C_{eb}$	-	60	-	

<sup>1)</sup>For calculation of  $R_{thJA}$  please refer to Application Note AN077 (Thermal Resistance Calculation)

<sup>2)</sup>Pulse test:  $t < 300\mu\text{s}; D < 2\%$

**DC current gain  $h_{FE} = f(I_C)$**

$V_{CE} = 1\text{ V}$

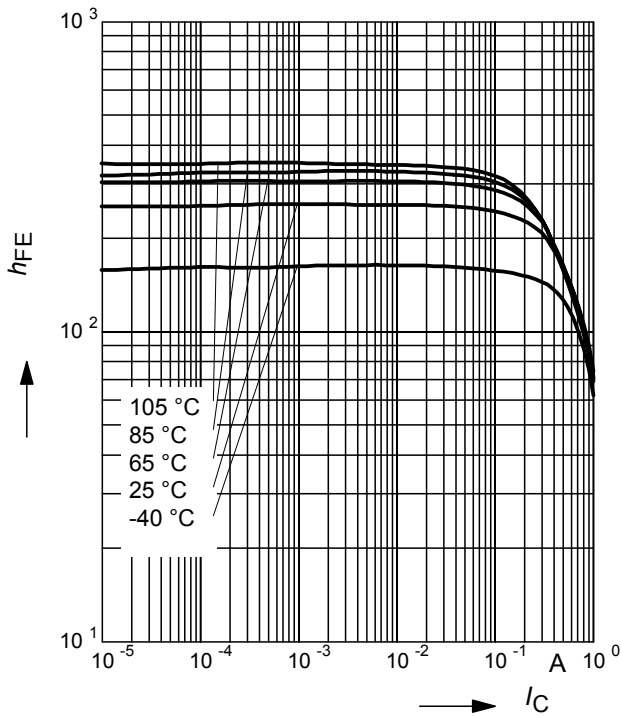

**Collector-emitter saturation voltage**

$I_C = f(V_{CEsat}), h_{FE} = 10$

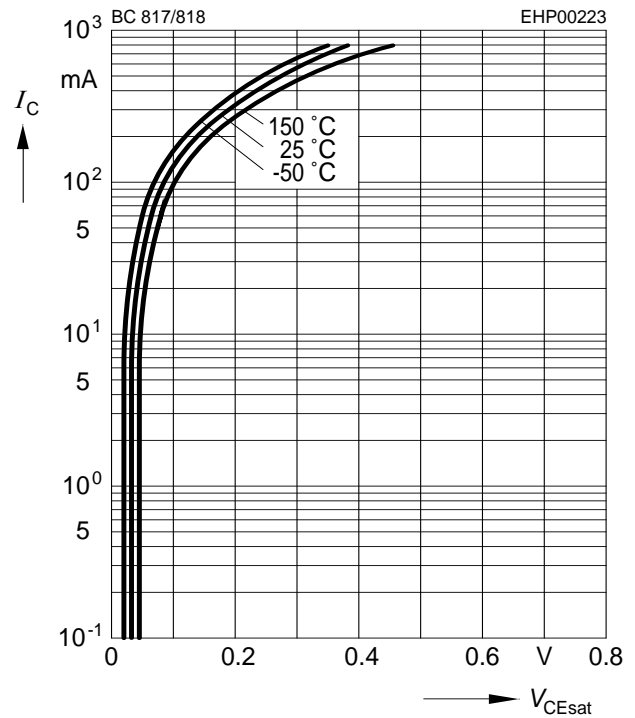

**Base-emitter saturation voltage**

$I_C = f(V_{BEsat}), h_{FE} = 10$

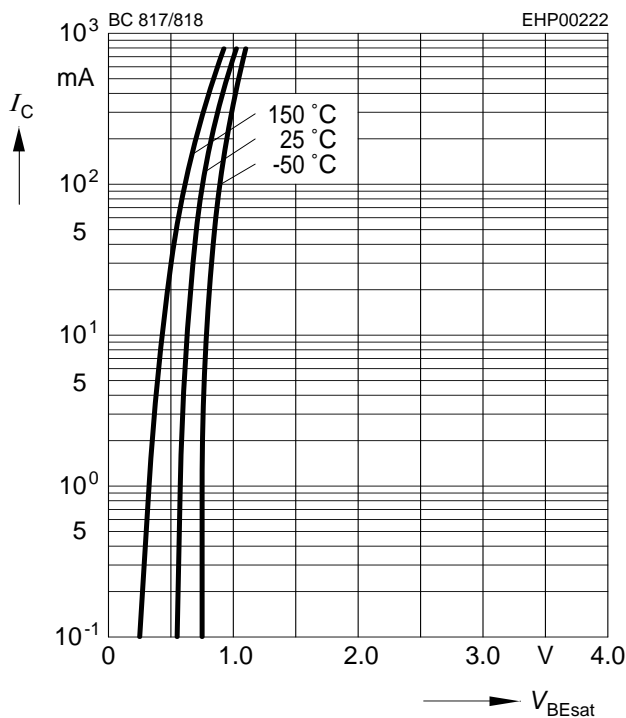

**Collector cutoff current  $I_{CBO} = f(T_A)$**

$V_{CBO} = 25\text{ V}$

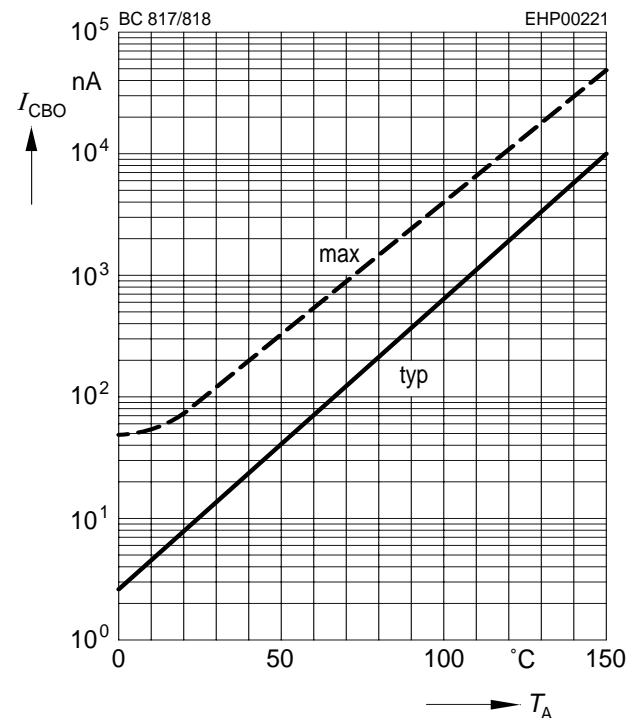

Transition frequency  $f_T = f(I_C)$

$V_{CE}$  = parameter in V,  $f = 2$  GHz

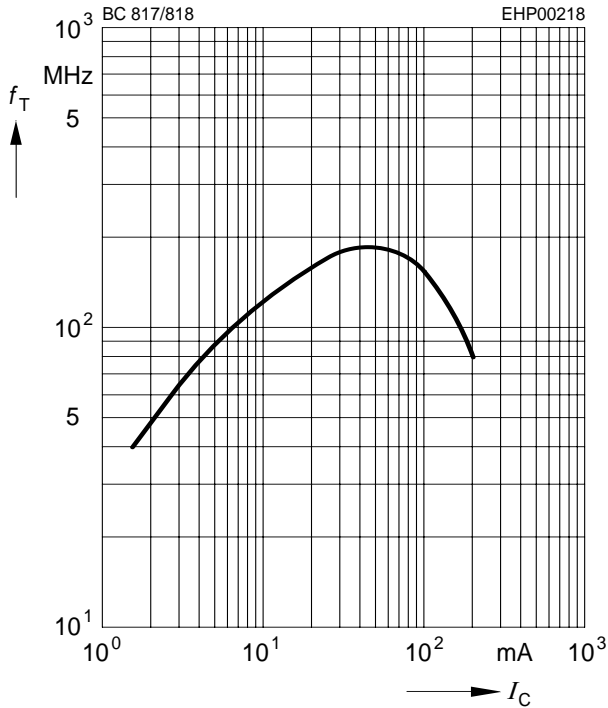

Collector-base capacitance  $C_{cb} = f(V_{CB})$

Emitter-base capacitance  $C_{eb} = f(V_{EB})$

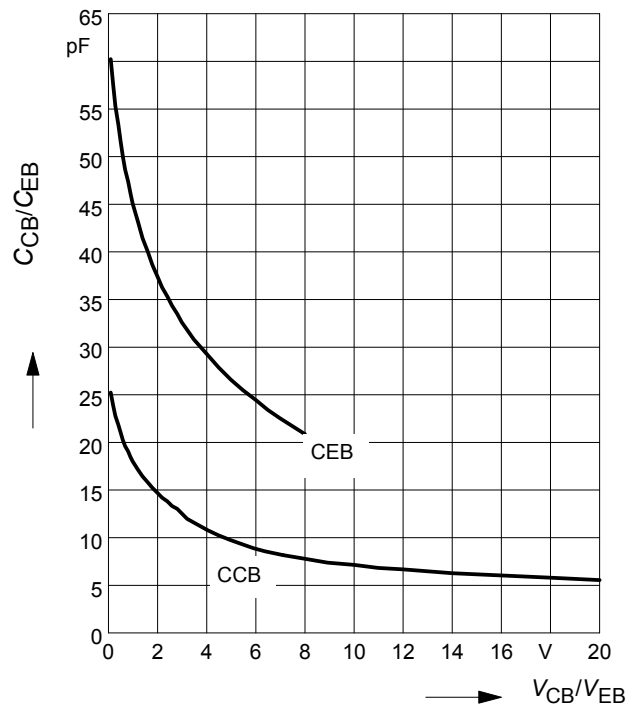

Total power dissipation  $P_{tot} = f(T_S)$

Permissible Pulse Load  $R_{thJS} = f(t_p)$

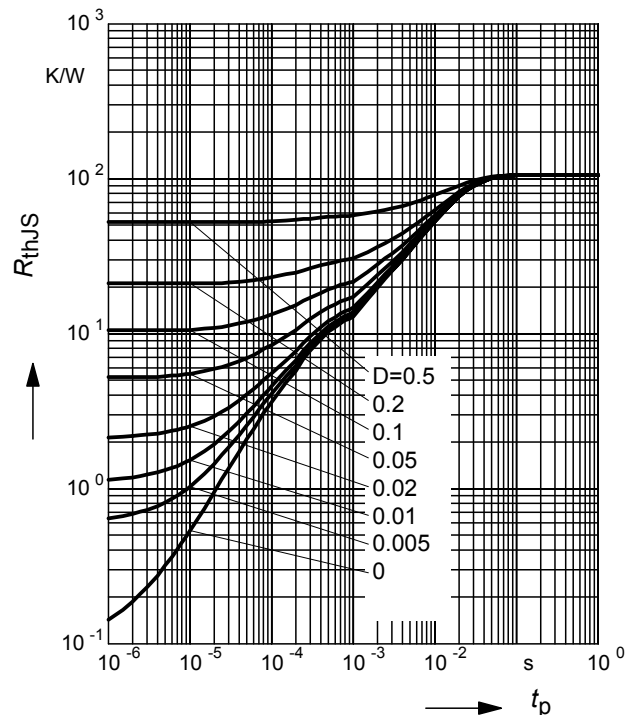
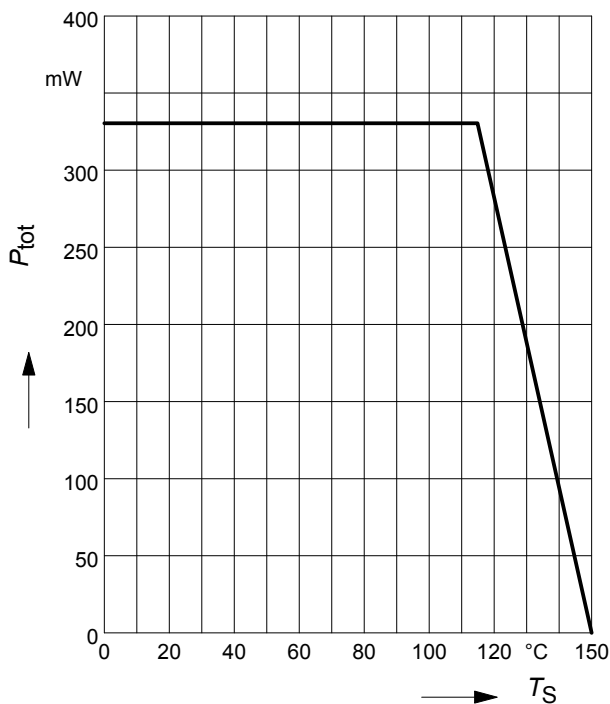

**Permissible Pulse Load**

$$P_{\text{totmax}}/P_{\text{totDC}} = f(t_p)$$

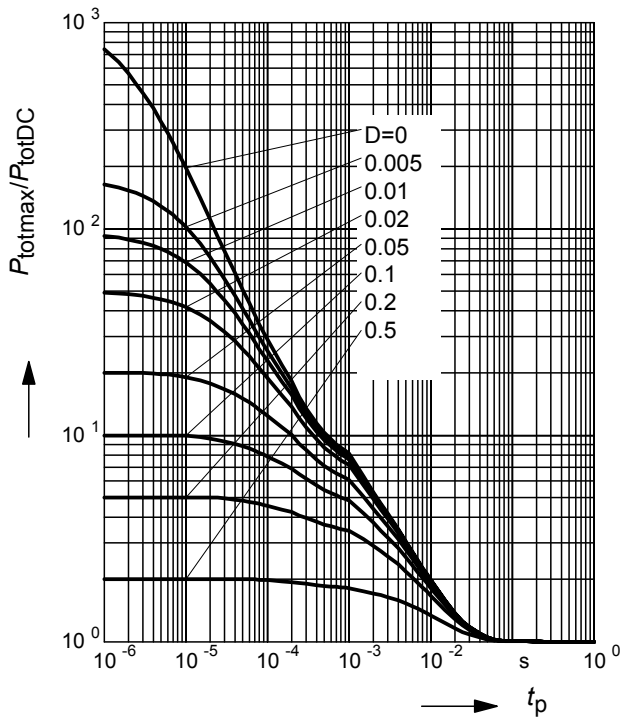

Package Outline



Foot Print

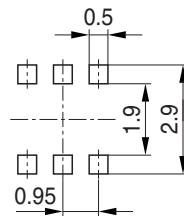

Marking Layout (Example)

Small variations in positioning of Date code, Type code and Manufacture are possible.



Standard Packing

Reel  $\varnothing$ 180 mm = 3.000 Pieces/Reel  
 Reel  $\varnothing$ 330 mm = 10.000 Pieces/Reel

For symmetric types no defined Pin 1 orientation in reel.

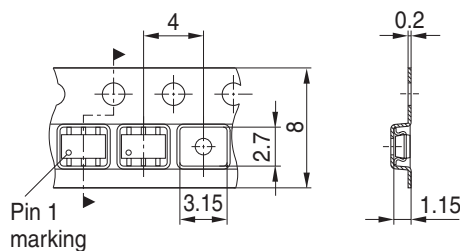

**Edition 2009-11-16**

**Published by  
Infineon Technologies AG  
81726 Munich, Germany**

**© 2009 Infineon Technologies AG  
All Rights Reserved.**

### **Legal Disclaimer**

The information given in this document shall in no event be regarded as a guarantee of conditions or characteristics. With respect to any examples or hints given herein, any typical values stated herein and/or any information regarding the application of the device, Infineon Technologies hereby disclaims any and all warranties and liabilities of any kind, including without limitation, warranties of non-infringement of intellectual property rights of any third party.

### **Information**

For further information on technology, delivery terms and conditions and prices, please contact the nearest Infineon Technologies Office ([www.infineon.com](http://www.infineon.com)).

### **Warnings**

Due to technical requirements, components may contain dangerous substances. For information on the types in question, please contact the nearest Infineon Technologies Office.

Infineon Technologies components may be used in life-support devices or systems only with the express written approval of Infineon Technologies, if a failure of such components can reasonably be expected to cause the failure of that life-support device or system or to affect the safety or effectiveness of that device or system. Life support devices or systems are intended to be implanted in the human body or to support and/or maintain and sustain and/or protect human life. If they fail, it is reasonable to assume that the health of the user or other persons may be endangered.