



LUXEON 2835 with FreshFocus Technology™

Accentuating freshness and overall visual appeal, making food irresistible



LUXEON 2835 with FreshFocus Technology creates impactful lighting by accentuating the freshness and overall visual appeal of a variety of fresh food in supermarkets, delis, butcher shops and bakeries. LUXEON 2835 with FreshFocus Technology brings out reds for greater visual appeal to meat; increases the appetite appeal of bread and pastries; exhibits the most natural and attractive fish; and emphasizes the “just picked” appearance for produce (fruits and vegetables) using a common 2835 platform.

FEATURES AND BENEFITS

Spectrum engineered products with focused color points to enable the right lighting for specific merchandise and application

Industry standard footprint for drop-in replacement designs

Maximum drive current of up to 240mA allows for reduction of LED count

IR and UV free, which keeps the merchandise fresher longer and prevents meat discoloration

3- and 5-step MacAdam ellipse color kits available

PRIMARY APPLICATIONS

Downlights

Indoor Area Lighting

- TLEDs

- Troffers

Lamps

Table of Contents

General Product Information	2
Product Test Conditions	2
Part Number Nomenclature	2
Lumen Maintenance	2
Environmental Compliance	2
Performance Characteristics	3
Product Selection Guide	3
Electrical and Thermal Characteristics	4
Absolute Maximum Ratings	4
Characteristic Curves	5
Spectral Power Distribution Characteristics	5
Light Output Characteristics	5
Forward Current Characteristics	6
Radiation Pattern Characteristics	7
Product Bin and Labeling Definitions	8
Decoding Product Bin Labeling	8
Luminous Flux Bins	8
Color Bin Definition	9
Forward Voltage Bins	12
Mechanical Dimensions	12
Reflow Soldering Guidelines	13
JEDEC Moisture Sensitivity	13
Solder Pad Design	14
Packaging Information	14
Pocket Tape Dimensions	14
Reel Dimensions	15

General Product Information

Product Test Conditions

LUXEON 2835 with FreshFocus Technology™ LEDs are tested and binned with a 20ms monopulse of 120mA at a junction temperature, T_j , of 25°C.

Part Number Nomenclature

Part numbers for LUXEON 2835 FreshFocus Line follow the convention below:

L 1 2 8 – **A A 0 0 C A 3 5 0 0 0 0 0**

Where:

- A A** – designates product type (PR=Produce, RM=Red Meat, MM=Marbled Meat, FS=Fish, BD=Bread)
- C** – designates binning current (C=120mA)
- A** – designates voltage of the part (A=3V)

Therefore, the following part number is used for a LUXEON 2835C with FreshFocus Technology for Marbled Meat, 3V:

L 1 2 8 – **M M 0 0 C A 3 5 0 0 0 0 0**

Lumen Maintenance

Please contact your local Sales Representative or Lumileds Technical Solutions Manager for more information about the long-term performance of this product.

Environmental Compliance

Lumileds LLC is committed to providing environmentally friendly products to the solid-state lighting market. LUXEON 2835 with FreshFocus Technology™ is compliant to the European Union directives on the restriction of hazardous substances in electronic equipment, namely the RoHS Directive 2011/65/EU and REACH Regulation (EC) 1907/2006. Lumileds LLC will not intentionally add the following restricted materials to its products: lead, mercury, cadmium, hexavalent chromium, polybrominated biphenyls (PBB) or polybrominated diphenyl ethers (PBDE).

Performance Characteristics

Product Selection Guide

Table 1. Product performance of LUXEON 2835 with FreshFocus Technology at 120mA, T_j=25°C.

PRODUCT	VOLTAGE	SPECTRUM	LUMINOUS FLUX ^[1, 2] (lm)		TYPICAL LUMINOUS EFFICACY (lm/W)	PART NUMBER
			MINIMUM	TYPICAL		
LUXEON 2835C	3V	Produce	39	44	123	L128-PR00CA3500000
		Red Meat	27	31	86	L128-RM00CA3500000
		Marbled Meat	26	30	84	L128-MM00CA3500000
		Fish	44	50	139	L128-FS00CA3500000
		Bread	43	47	131	L128-BD00CA3500000

Notes for Table 1:

1. Lumileds maintains a tolerance of ±7.5% on luminous flux measurements.
2. Luminous flux is based upon mounted package on highly reflective surface at T_j=25°C.

Optical Characteristics

Table 2. Optical characteristics for LUXEON 2835 with FreshFocus Technology at 120mA, T_j=25°C.

PART NUMBER	TYPICAL TOTAL INCLUDED ANGLE ^[1]	TYPICAL VIEWING ANGLE ^[2]
L128-xx00CA350000	160°	120°

Notes for Table 2:

1. Total angle at which 90% of total luminous flux is captured.
2. Viewing angle is the off axis angle from the LED centerline where the luminous intensity is ½ of the peak value.

Electrical and Thermal Characteristics

Table 3. Electrical and thermal characteristics for LUXEON 2835 with FreshFocus Technology at 120mA, T_j=25°C.

PART NUMBER	FORWARD VOLTAGE ^[1] (V _f)			TYPICAL TEMPERATURE COEFFICIENT OF FORWARD VOLTAGE ^[2] (mV/°C)	TYPICAL THERMAL RESISTANCE—JUNCTION TO SOLDER PAD (°C/W)
	MINIMUM	TYPICAL	MAXIMUM		
L128-xx00CA350000	2.9	3.0	3.2	-3.0 to -6.0	21

Notes for Table 3:

1. Lumileds maintains a tolerance of ±0.10V on forward voltage measurements.
2. Measured between 25°C and 85°C.

Absolute Maximum Ratings

Table 4. Absolute maximum ratings for LUXEON 2835 with FreshFocus Technology.

PARAMETER	MAXIMUM PERFORMANCE
DC Forward Current ^[1, 2]	240mA
Peak Pulsed Forward Current ^[1, 3]	300mA
LED Junction Temperature ^[1] (DC & Pulse)	125°C
ESD Sensitivity (ANSI/ESDA/JEDEC JS-001-2012)	Class 2
Operating Case Temperature ^[1]	-40°C to 105°C
LED Storage Temperature	-40°C to 105°C
Soldering Temperature	JEDEC 020c 260°C
Allowable Reflow Cycles	3
Reverse Voltage (V _{reverse}) ^[4, 5]	5

Notes for Table 4:

1. Proper current derating must be observed to maintain the junction temperature below the maximum allowable junction temperature.
2. Residual periodic variations due to power conversion from alternating current (AC) to direct current (DC), also called "ripple," are acceptable if the following conditions are met:
 - The frequency of the ripple current is 100Hz or higher
 - The average current for each cycle does not exceed the maximum allowable DC forward current
 - The maximum amplitude of the ripple does not exceed the maximum peak pulsed forward current
3. At ≤50% duty cycle with pulse width of 5ms.
4. Transient reverse voltages and surge currents due to electrical switching or supply interruptions are acceptable if these events do not last for more than 10ms, the amplitude of the reverse voltage does not exceed 5V and the reverse current is less than 220uA.
5. Max 5V reverse for up to 10s is an acceptable beginning of life, one time test condition.

Characteristic Curves

Spectral Power Distribution Characteristics

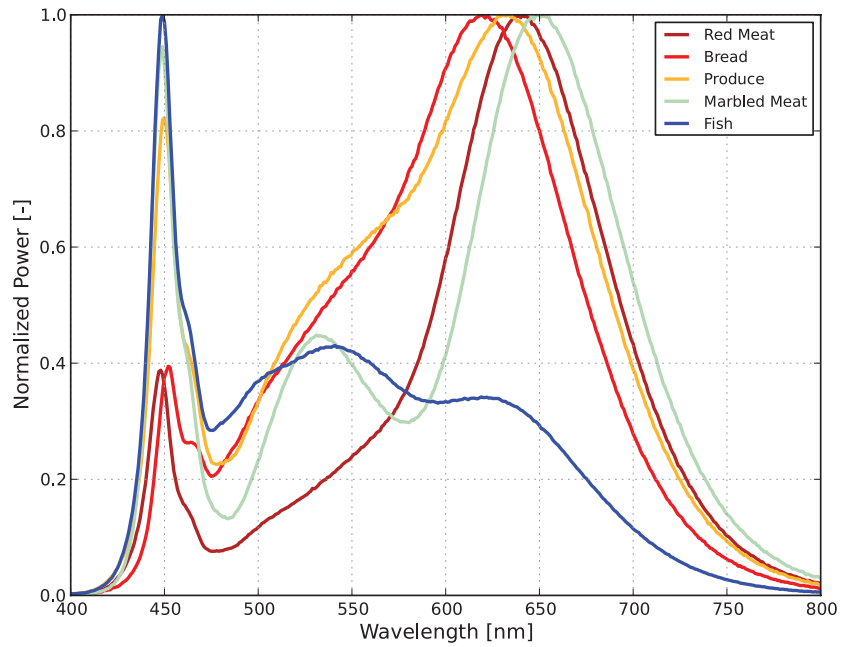

Figure 1. Typical normalized power vs. wavelength for LUXEON 2835 with FreshFocus Technology at 120mA, $T_j=25^{\circ}\text{C}$.

Light Output Characteristics

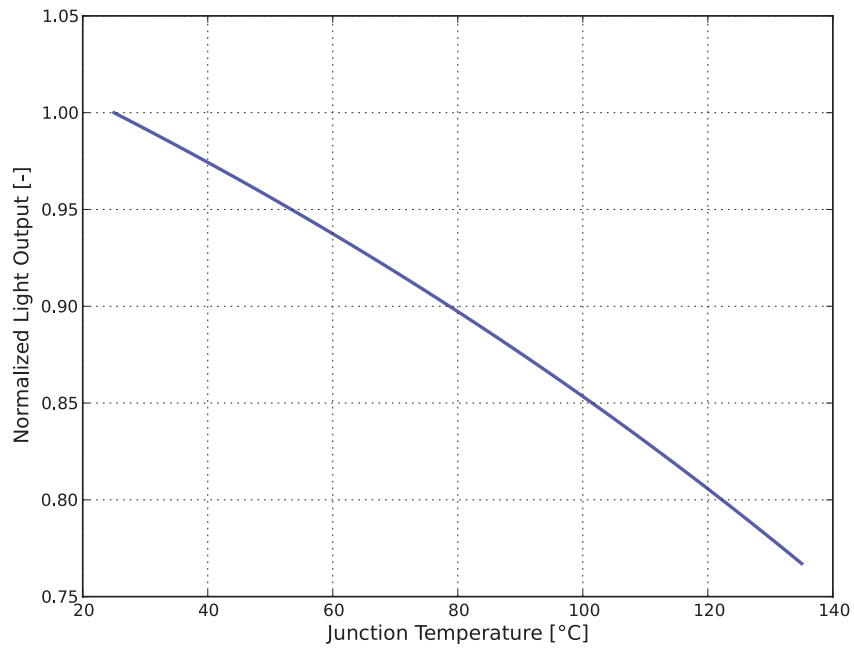

Figure 2. Typical normalized light output vs. junction temperature for LUXEON 2835 with FreshFocus Technology at 120mA.

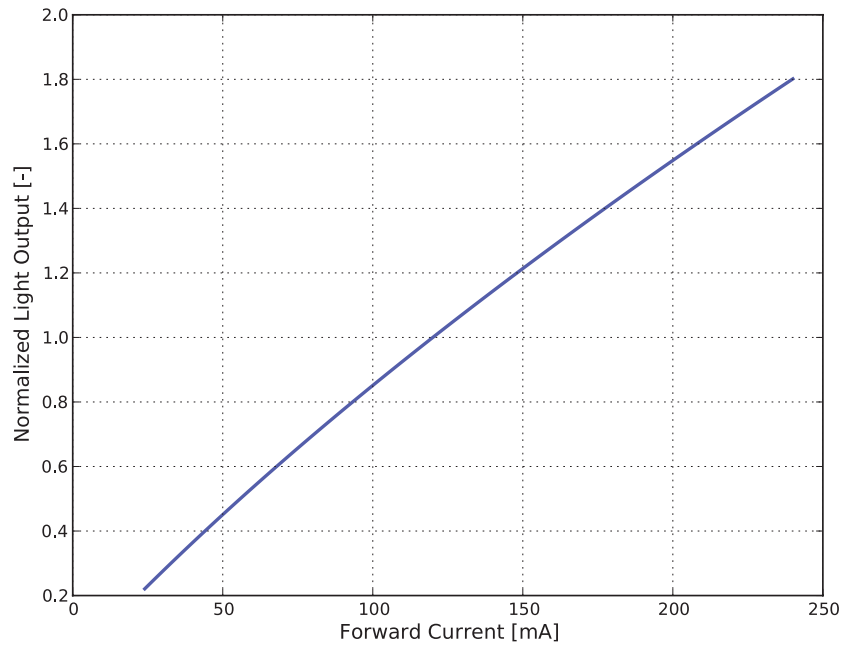

Figure 3. Typical normalized light output vs. forward current for LUXEON 2835 with FreshFocus Technology at $T_j=25^\circ\text{C}$.

Forward Current Characteristics

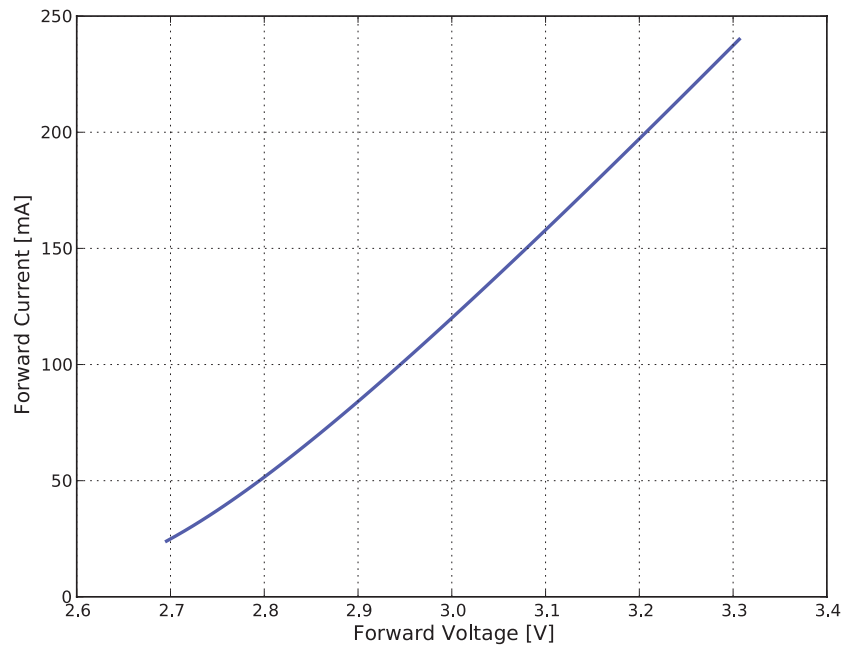

Figure 4. Typical forward current vs. forward voltage for LUXEON 2835 with FreshFocus Technology at $T_j=25^\circ\text{C}$.

Radiation Pattern Characteristics

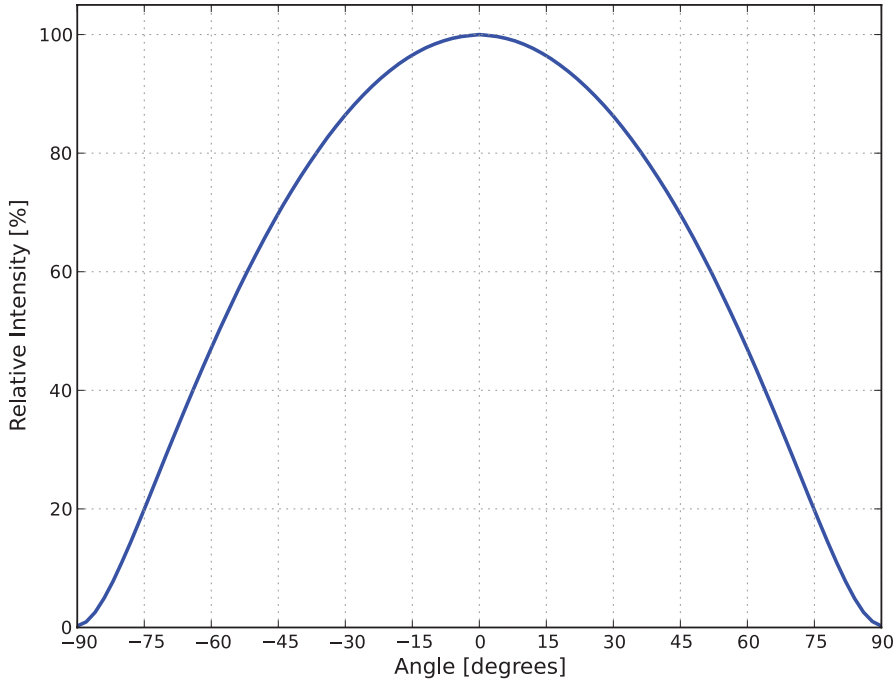

Figure 5. Typical radiation pattern for LUXEON 2835 with FreshFocus Technology at 120mA, T_J=25°C.

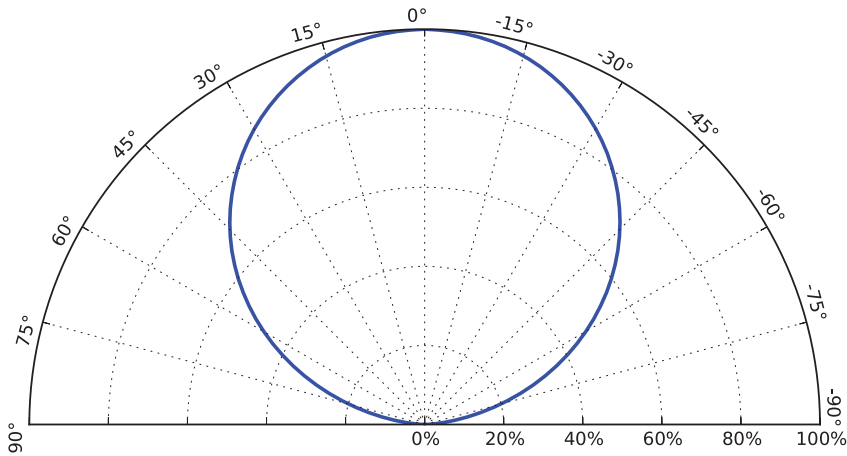

Figure 6. Typical polar radiation pattern for LUXEON 2835 with FreshFocus Technology at 120mA, T_J=25°C.

Product Bin and Labeling Definitions

Decoding Product Bin Labeling

In the manufacturing of semiconductor products, there are variations in performance around the average values given in the technical datasheet. For this reason, Lumileds bins LED components for luminous flux or radiometric power, color point, peak or dominant wavelength and forward voltage.

LUXEON 2835 with FreshFocus Technology LEDs are labeled using a 4-digit alphanumeric CAT code following the format below:

A B C D

Where:

- A** – designates luminous flux bin (example: R=48 to 52 lumens, T=56 to 60 lumens)
- B C** – designates correlated color bin (example: JD, JE, JF, JG, JH for Bread parts)
- D** – designates forward voltage bin (example: V=3.0 to 3.1V, W=3.0 to 3.1V)

Therefore, a LUXEON 2835 with FreshFocus Technology with a lumen range of 48 to 52, color bin of JD and a forward voltage range of 3.0 to 3.1V has the following CAT code:

R J D W

Luminous Flux Bins

Table 5 lists the standard luminous flux bins for LUXEON 2835C with FreshFocus Technology emitters. Although several bins are outlined, product availability in a particular bin varies by production run and by product performance. Not all bins are available in all CCTs.

Table 5. Luminous flux bin definitions for LUXEON 2835 with FreshFocus Technology, $T_j=85^\circ\text{C}$.

PRODUCT	BIN	LUMINOUS FLUX ⁽¹⁾ (lm)	
		MINIMUM	MAXIMUM
LUXEON 2835C	J	24	28
	K	28	32
	L	32	36
	M	36	40
	P	40	44
	Q	44	48
	R	48	52
	S	52	56
	T	56	60

Notes for Table 5:

1. Lumileds maintains a tolerance of $\pm 7.5\%$ on luminous flux measurements.

Color Bin Definition

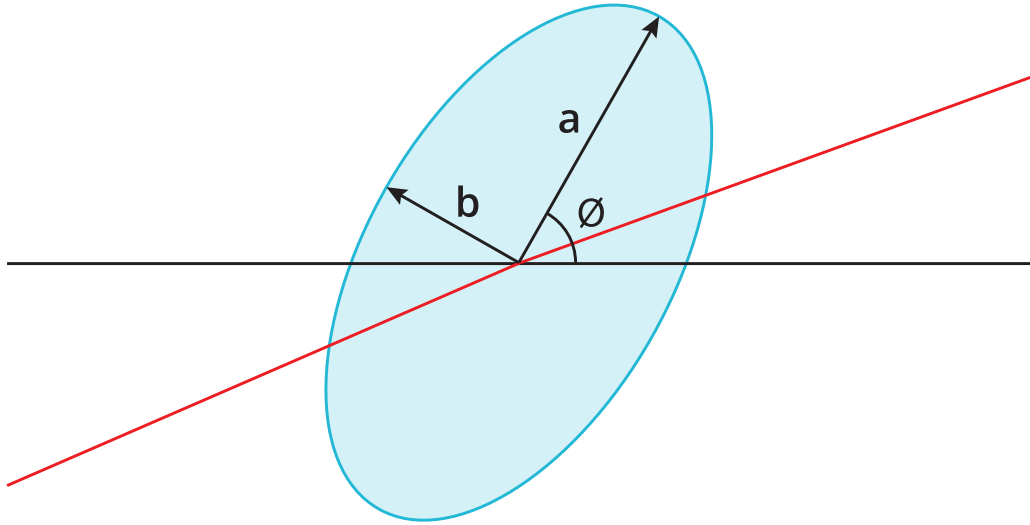

Figure 7. 3- and 5-step MacAdam ellipse illustration for Tables 6a–6e.

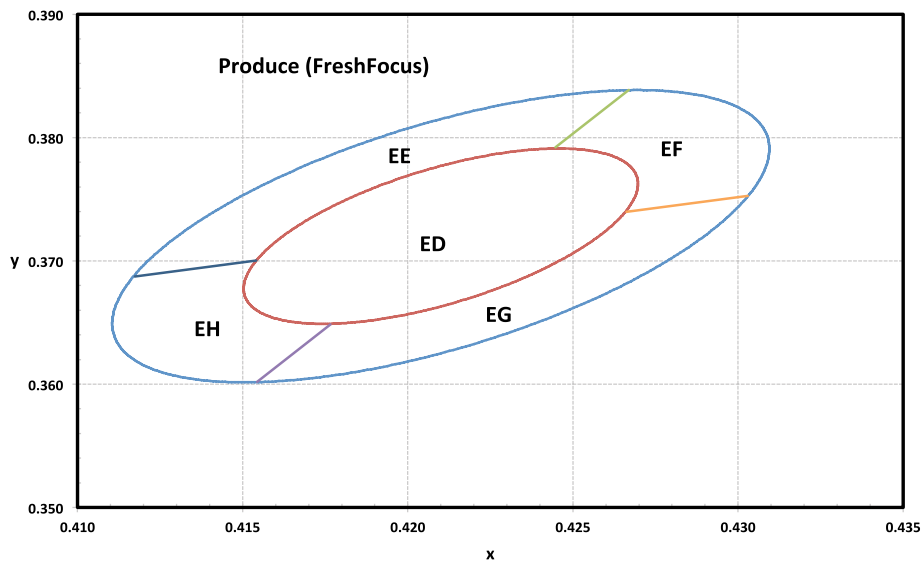

Figure 8a. 1/5th color bin structure for LUXEON 2835 with FreshFocus Technology for Produce, 120mA, $T_j=25^\circ\text{C}$.

Table 6a. 3- and 5-step MacAdam ellipse color bin definitions for LUXEON 2835 with FreshFocus Technology for Produce at $T_j=25^\circ\text{C}$.

SPECTRUM	COLOR SPACE	CENTER POINT ⁽¹⁾ (cx, cy)	MAJOR AXIS, a	MINOR AXIS, b	ELLIPSE ROTATION ANGLE, θ
Produce	Single 3-step MacAdam ellipse	(0.421, 0.372)	0.00834	0.00408	53.2°
	Single 5-step MacAdam ellipse	(0.421, 0.372)	0.01390	0.00680	53.2°

Notes for Table 6a:

1. Lumileds maintains a tolerance of ± 0.007 on x and y color coordinates in the CIE 1931 color space.

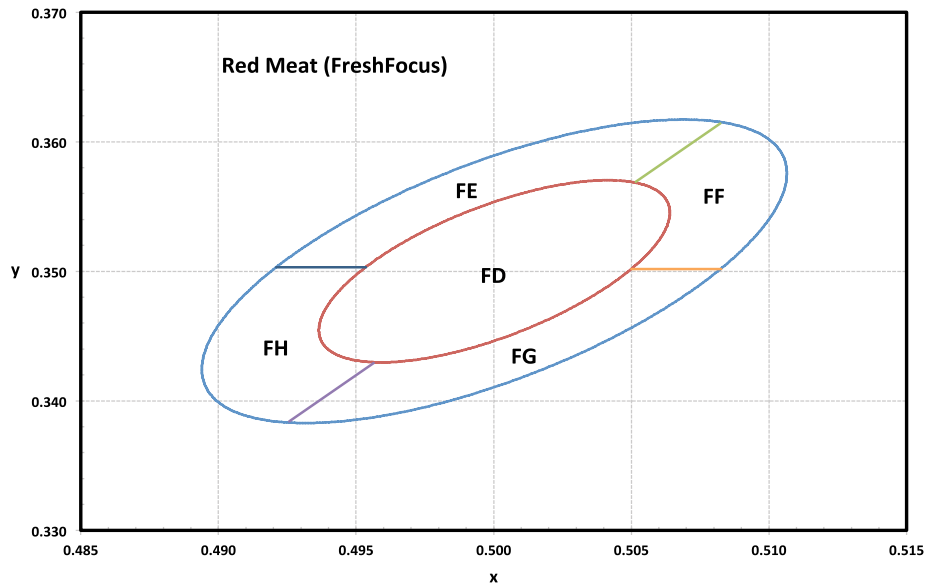

Figure 8b. 1/5th color bin structure for LUXEON 2835 with FreshFocus Technology for Red Meat, 120mA, $T_j=25^\circ\text{C}$.

Table 6b. 3- and 5-step MacAdam ellipse color bin definitions for LUXEON 2835 with FreshFocus Technology for Red Meat at $T_j=25^\circ\text{C}$.

NOMINAL CCT	COLOR SPACE	CENTER POINT ^[1] (cx, cy)	MAJOR AXIS, a	MINOR AXIS, b	ELLIPSE ROTATION ANGLE, θ
Red Meat	Single 3-step MacAdam ellipse	(0.500, 0.350)	0.00862	0.00397	49.3°
	Single 5-step MacAdam ellipse	(0.500, 0.350)	0.01437	0.00662	49.3°

Notes for Table 6b:

1. Lumileds maintains a tolerance of ± 0.007 on x and y color coordinates in the CIE 1931 color space.

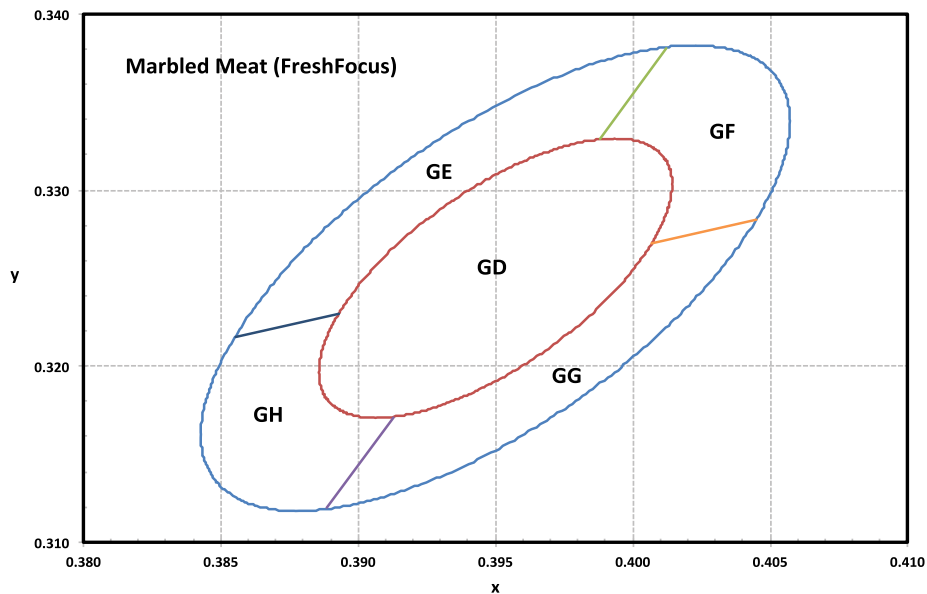

Figure 8c. 1/5th color bin structure for LUXEON 2835 with FreshFocus Technology for Marbled Meat, 120mA, $T_j=25^\circ\text{C}$.

Table 6c. 3- and 5-step MacAdam ellipse color bin definitions for LUXEON 2835 with FreshFocus Technology for Marbled Meat at $T_j=25^\circ\text{C}$.

NOMINAL CCT	COLOR SPACE	CENTER POINT ^[1] (cx, cy)	MAJOR AXIS, a	MINOR AXIS, b	ELLIPSE ROTATION ANGLE, θ
Marbled Meat	Single 3-step MacAdam ellipse	(0.395, 0.325)	0.00939	0.00402	53.7°
	Single 5-step MacAdam ellipse	(0.395, 0.325)	0.01565	0.00670	53.7°

Notes for Table 6c:

1. Lumileds maintains a tolerance of ± 0.007 on x and y color coordinates in the CIE 1931 color space.

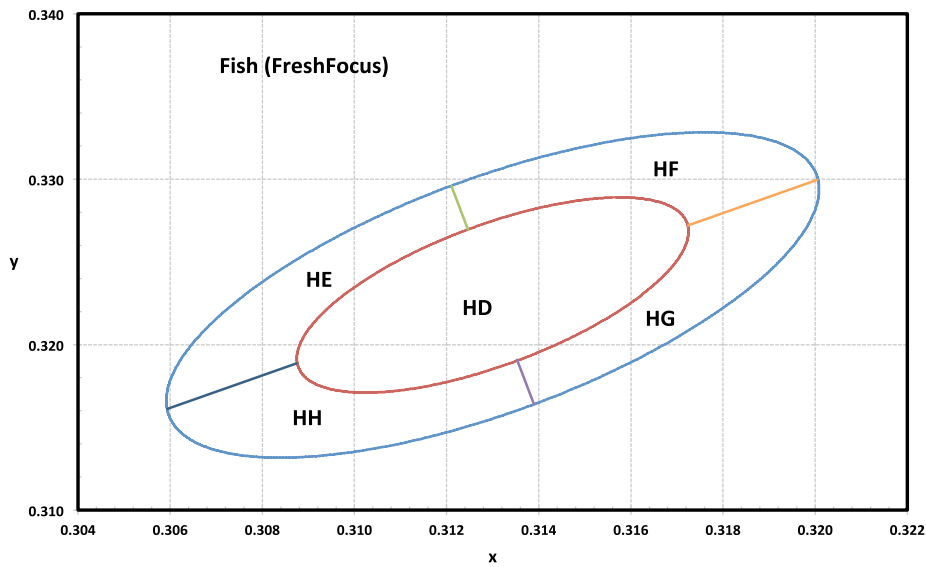

Figure 8d. 1/5th color bin structure for LUXEON 2835 with FreshFocus Technology for Fish, 120mA, $T_j=25^\circ\text{C}$.

Table 6d. 3- and 5-step MacAdam ellipse color bin definitions for LUXEON 2835 with FreshFocus Technology for Fish at $T_j=25^\circ\text{C}$.

NOMINAL CCT	COLOR SPACE	CENTER POINT ^[1] (cx, cy)	MAJOR AXIS, a	MINOR AXIS, b	ELLIPSE ROTATION ANGLE, θ
Fish	Single 3-step MacAdam ellipse	(0.313, 0.323)	0.00669	0.00285	58.6°
	Single 5-step MacAdam ellipse	(0.313, 0.323)	0.01115	0.00475	58.6°

Notes for Table 6d:

1. Lumileds maintains a tolerance of ± 0.007 on x and y color coordinates in the CIE 1931 color space.

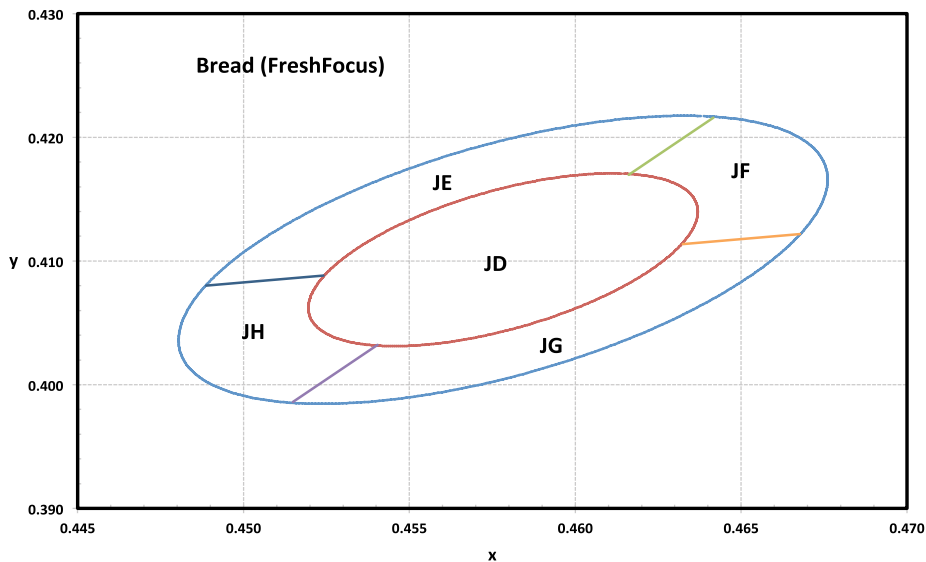

Figure 8e. 1/5th color bin structure for LUXEON 2835 with FreshFocus Technology for Bread, 120mA, $T_j=25^\circ\text{C}$.

Table 6e. 3- and 5-step MacAdam ellipse color bin definitions for LUXEON 2835 with FreshFocus Technology for Bread at $T_j=25^\circ\text{C}$.

NOMINAL CCT	COLOR SPACE	CENTER POINT ^[1] (cx, cy)	MAJOR AXIS, a	MINOR AXIS, b	ELLIPSE ROTATION ANGLE, θ
Bread	Single 3-step MacAdam ellipse	(0.4578, 0.4101)	0.00810	0.00420	53.7°
	Single 5-step MacAdam ellipse	(0.4578, 0.4101)	0.01350	0.00700	53.7°

Notes for Table 6e:

1. Lumileds maintains a tolerance of ± 0.007 on x and y color coordinates in the CIE 1931 color space.

Forward Voltage Bins

Table 7. Forward voltage bin definitions for LUXEON 2835 with FreshFocus Technology at 120mA, T_j=25°C.

PRODUCT	BIN	FORWARD VOLTAGE ⁽¹⁾ (V _f)	
		MINIMUM	MAXIMUM
LUXEON 2835C	V	2.9	3.0
	W	3.0	3.1
	X	3.1	3.2
	Y	3.2	3.3

Notes for Table 7:

1. Lumileds maintains a tolerance of ±0.10V on forward voltage measurements.

Mechanical Dimensions

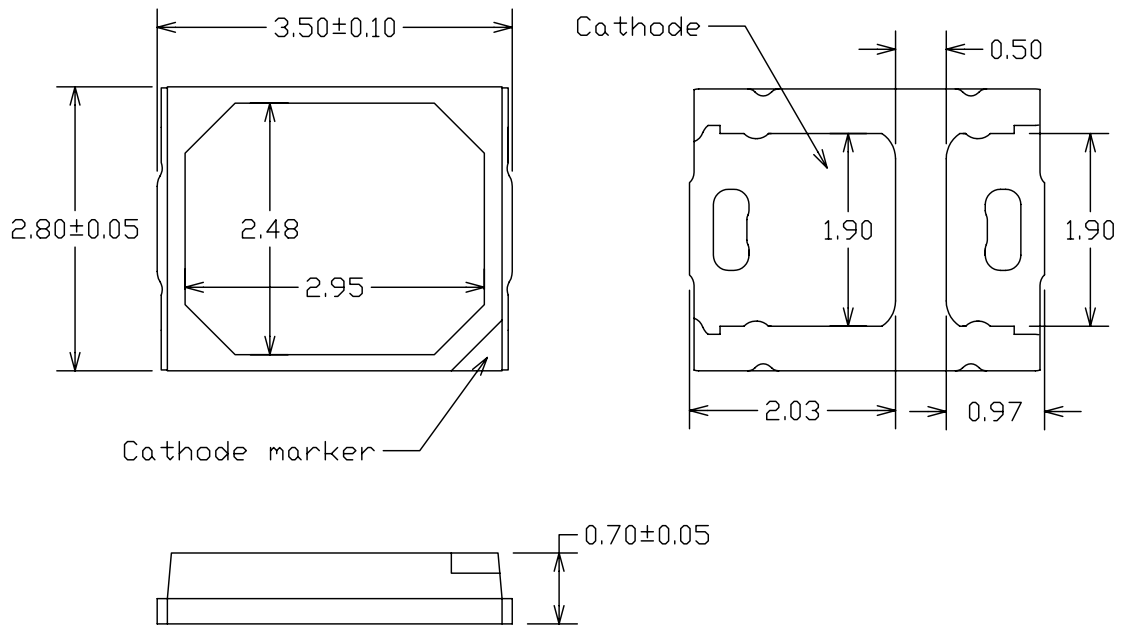

Figure 9. Mechanical dimensions for LUXEON 2835 with FreshFocus Technology.

Notes for Figure 9:

1. Drawings are not to scale.
2. All dimensions are in millimeters.

Reflow Soldering Guidelines

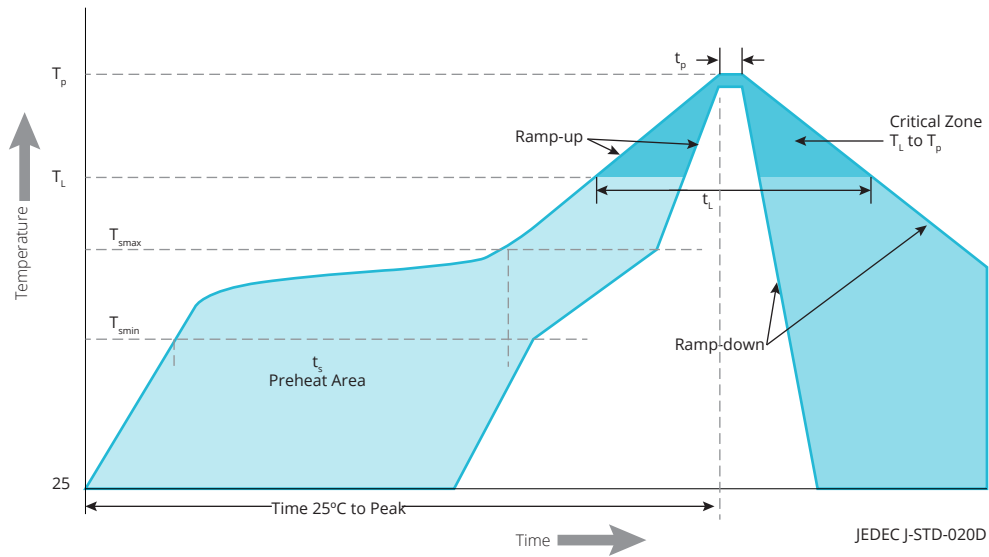

Figure 10. Visualization of the acceptable reflow temperature profile as specified in Table 8.

Table 8. Reflow profile characteristics for LUXEON 2835 with FreshFocus Technology.

PROFILE FEATURE	LEAD-FREE ASSEMBLY
Preheat Minimum Temperature (T_{smin})	150°C
Preheat Maximum Temperature (T_{smax})	200°C
Preheat Time (t_{smin} to t_{smax})	60 to 120 seconds
Ramp-Up Rate (T_L to T_p)	3°C / second maximum
Liquidus Temperature (T_L)	217°C
Time Maintained Above Temperature T_L (t_t)	60 to 150 seconds
Peak / Classification Temperature (T_p)	260°C
Time Within 5°C of Actual Temperature (t_p)	20 to 40 seconds
Ramp-Down Rate (T_p to T_L)	6°C / second maximum
Time 25°C to Peak Temperature	8 minutes maximum

JEDEC Moisture Sensitivity

Table 9. Moisture sensitivity levels for LUXEON 2835 with FreshFocus Technology.

LEVEL	FLOOR LIFE		SOAK REQUIREMENTS STANDARD	
	TIME	CONDITIONS	TIME	CONDITIONS
3	168 Hours	≤30°C / 30% RH	192 Hours +5 / -0	30°C / 60% RH

Solder Pad Design

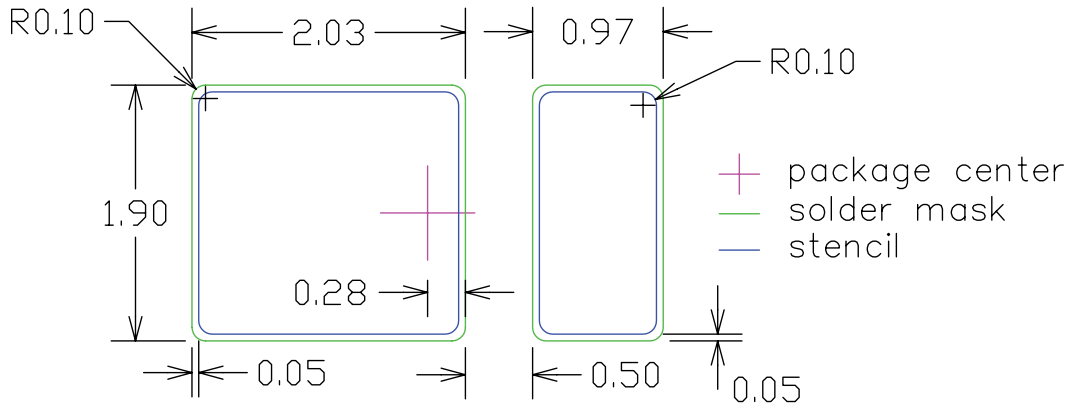

Figure 11. Recommended PCB solder pad layout for LUXEON 2835 with FreshFocus Technology.

Notes for Figure 11:

1. Drawings are not to scale.
2. All dimensions are in millimeters.

Packaging Information

Pocket Tape Dimensions

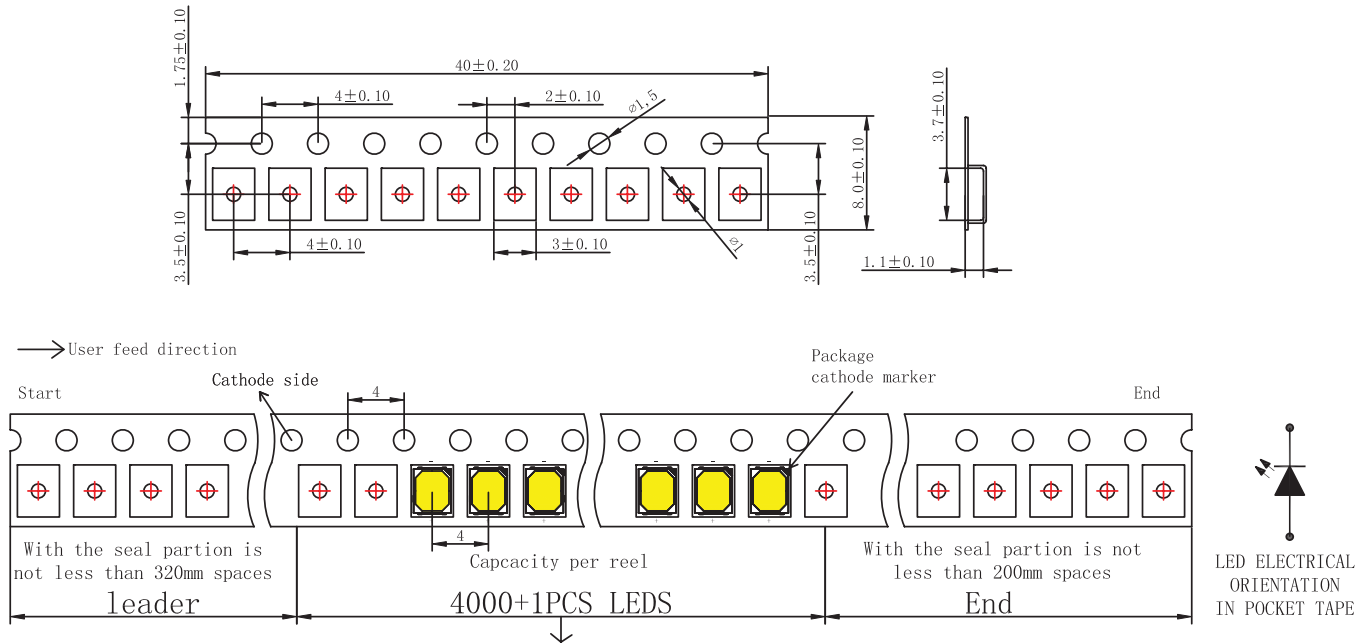

Figure 12. Pocket tape dimensions for LUXEON 2835 with FreshFocus Technology.

Notes for Figure 12:

1. Drawings are not to scale.
2. All dimensions are in millimeters.

Reel Dimensions

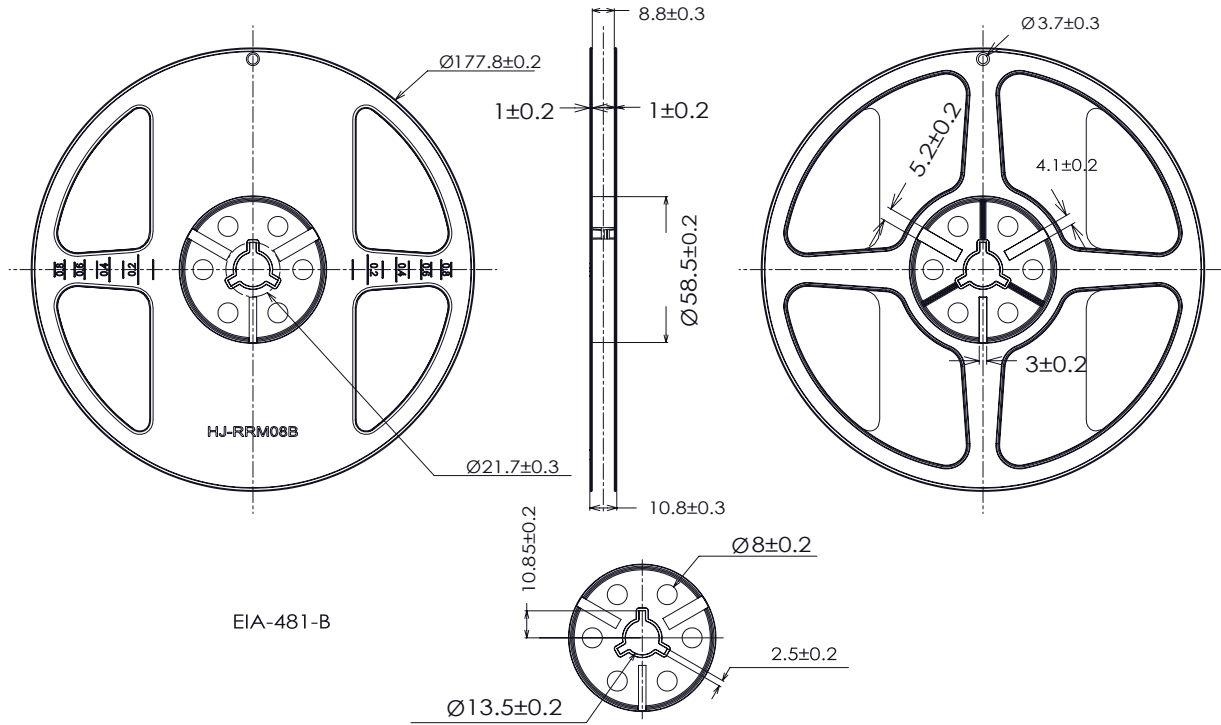

Figure 13. Reel dimensions for LUXEON 2835 with FreshFocus Technology.

Notes for Figure 13:

1. Drawings are not to scale.
2. All dimensions are in millimeters.

About Lumileds

Companies developing automotive, mobile, IoT and illumination lighting applications need a partner who can collaborate with them to push the boundaries of light. With over 100 years of inventions and industry firsts, Lumileds is a global lighting solutions company that helps customers around the world deliver differentiated solutions to gain and maintain a competitive edge. As the inventor of Xenon technology, a pioneer in halogen lighting and the leader in high performance LEDs, Lumileds builds innovation, quality and reliability into its technology, products and every customer engagement. Together with its customers, Lumileds is making the world better, safer, more beautiful—with light.

To learn more about our lighting solutions, visit lumileds.com.



©2020 Lumileds Holding B.V. All rights reserved.
LUXEON is a registered trademark of the Lumileds Holding B.V. in the United States and other countries.
lumileds.com

Neither Lumileds Holding B.V. nor its affiliates shall be liable for any kind of loss of data or any other damages, direct, indirect or consequential, resulting from the use of the provided information and data. Although Lumileds Holding B.V. and/or its affiliates have attempted to provide the most accurate information and data, the materials and services information and data are provided "as is," and neither Lumileds Holding B.V. nor its affiliates warrants or guarantees the contents and correctness of the provided information and data. Lumileds Holding B.V. and its affiliates reserve the right to make changes without notice. You as user agree to this disclaimer and user agreement with the download or use of the provided materials, information and data. A listing of Lumileds product/patent coverage may be accessed at lumileds.com/patents.