

Parameter	Rating	Units
Blocking Voltage	60	$V_P$
Load Current	600	$mA_{rms} / mA_{DC}$
Input Control Current	2	mA
On-Resistance (max)	1	$\Omega$

### Features

- Low Input Control Current: 2mA
- 3750V<sub>rms</sub> Input/Output Isolation
- Greater Reliability than Electromechanical Relays
- No EMI/RFI Generation
- Small 8-Pin Package
- Surface Mount Tape & Reel Version Available

### Applications

- Instrumentation
  - Multiplexers
  - Data Acquisition
  - Electronic Switching
  - I/O Subsystems
- Meters (Watt-Hour, Water, Gas)
- Medical Equipment—Patient/Equipment Isolation
- Security
- Industrial Controls
- Automotive

### Description

The PAA132 Solid State Relay has two independent, single-pole, normally open (1-Form-A), relays in a single 8-pin package. It employs optically coupled MOSFET technology to provide 3750V<sub>rms</sub> of input to output isolation.

Its optically coupled outputs, which use the patented OptoMOS architecture, are controlled by a highly efficient infrared LED.

By incorporating two independent, single-pole relays into a single 8-pin package, the PAA132 saves board space by providing a more compact design solution than two discrete single-pole relays in a variety of applications.

### Approvals

- UL Recognized Component: File # E76270
- TUV EN 62368-1: Certificate # B 082667 0008

### Ordering Information

Part #	Description
PAA132	8-Pin DIP (50/Tube)
PAA132S	8-Pin Surface Mount (50/Tube)
PAA132STR	8-Pin Surface Mount (1,000/Reel)

### Pin Configuration

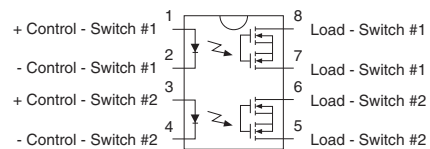

### Switching Characteristics of Normally Open Devices

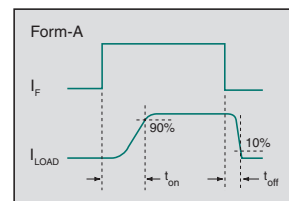

### Absolute Maximum Ratings @ 25°C

Parameter	Ratings	Units
Blocking Voltage	60	V <sub>P</sub>
Reverse Input Voltage	5	V
Input Control Current Peak (10ms)	50	mA
	1	A
Input Power Dissipation <sup>1</sup>	150	mW
Total Power Dissipation <sup>2</sup>	800	mW
Isolation Voltage, Input to Output	3750	V <sub>rms</sub>
Operational Temperature, Ambient	-40 to +85	°C
Storage Temperature	-40 to +125	°C

Absolute Maximum Ratings are stress ratings. Stresses in excess of these ratings can cause permanent damage to the device. Functional operation of the device at conditions beyond those indicated in the operational sections of this data sheet is not implied.

<sup>1</sup> Derate linearly 1.33 mW / °C

<sup>2</sup> Derate output power linearly 6.67 mW / °C

### Electrical Characteristics @ 25°C

Parameter	Conditions	Symbol	Min	Typ	Max	Units
<b>Output Characteristics</b>						
Blocking Voltage	I <sub>L</sub> =1μA	V <sub>DRM</sub>	60	-	-	V <sub>P</sub>
Load Current	-	I <sub>L</sub>	-	-	600	mA <sub>rms</sub> / mA <sub>DC</sub>
On-Resistance <sup>2</sup>	I <sub>L</sub> =600mA	R <sub>ON</sub>	-	0.85	1	Ω
Off-State Leakage Current	V <sub>L</sub> =60V <sub>P</sub>	I <sub>LEAK</sub>	-	-	1	μA
<b>Switching Speeds</b>						
Turn-On	I <sub>F</sub> = 5mA, V <sub>L</sub> = 10V	t <sub>on</sub>	-	-	5	ms
Turn-Off		t <sub>off</sub>	-	-	2	ms
Output Capacitance	V <sub>L</sub> =50V, f=1MHz	C <sub>OUT</sub>	-	25	-	pF
<b>Input Characteristics</b>						
Input Control Current to Activate	I <sub>L</sub> = 600mA	I <sub>F</sub>	-	-	2	mA
Input Control Current to Deactivate	-	I <sub>F</sub>	0.2	-	-	mA
Input Voltage Drop	I <sub>F</sub> = 10mA	V <sub>F</sub>	0.9	1.36	1.5	V
Reverse Input Current	V <sub>R</sub> = 5V	I <sub>R</sub>	-	-	10	μA
<b>Common Characteristics</b>						
Capacitance Input to Output	-	C <sub>I/O</sub>	-	3	-	pF

<sup>1</sup> If both poles operate, then the load current must be derated so that the package power dissipation value is not exceeded.

<sup>2</sup> Measurement taken within one second of on-time.

**PERFORMANCE DATA\***

**Typical LED Forward Voltage Drop**  
(N=50,  $I_F=5mA$ )

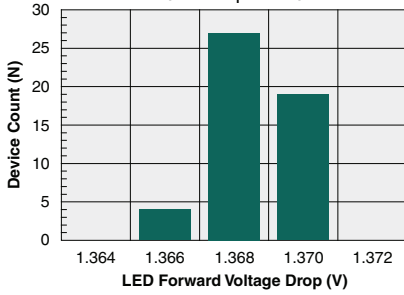

**Typical Turn-On Time**  
(N=50,  $I_F=5mA$ ,  $I_L=100mA$ )

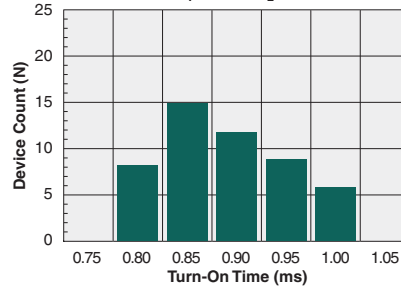

**Typical Turn-Off Time**  
(N=50,  $I_F=5mA$ ,  $I_L=100mA$ )

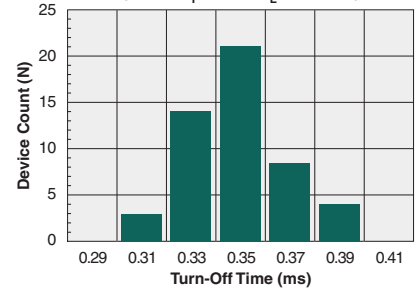

**Typical  $I_F$  for Switch Operation**  
(N=50,  $I_L=600mA$ )

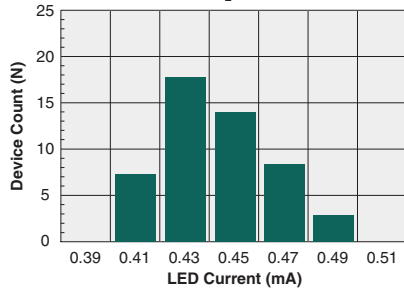

**Typical  $I_F$  for Switch Dropout**  
(N=50,  $I_L=600mA$ )

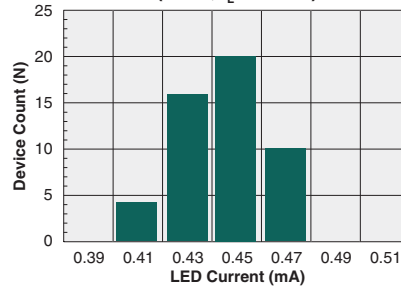

**Typical On-Resistance Distribution**  
(N=50,  $I_F=5mA$ ,  $I_L=600mA$ )

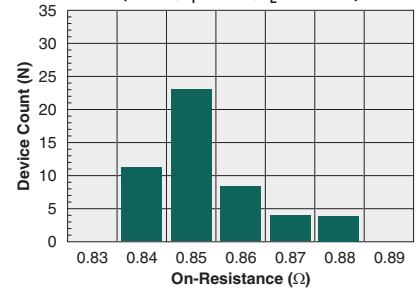

**Typical Blocking Voltage Distribution**  
(N=50)

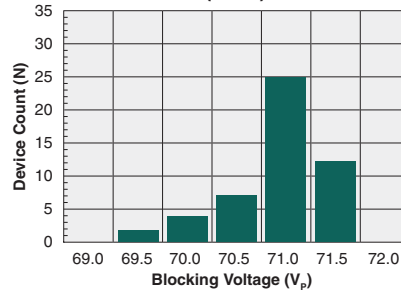

**Typical LED Forward Voltage Drop vs. Temperature**

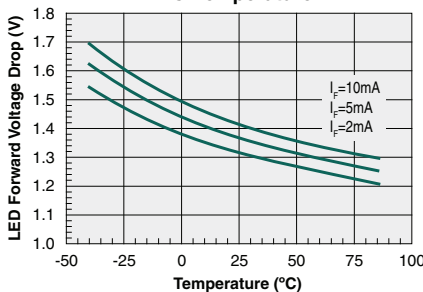

**Typical Turn-On Time vs. LED Forward Current**  
( $I_L=80mA$ )

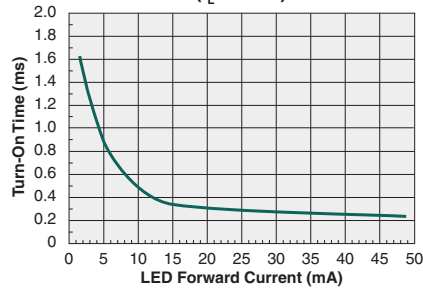

**Typical Turn-Off Time vs. LED Forward Current**  
( $I_L=80mA$ )

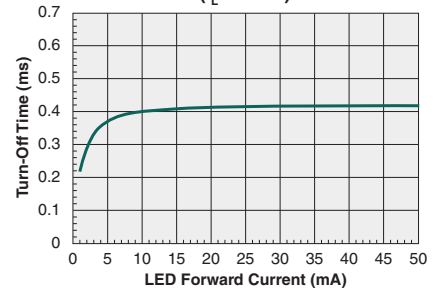

\*Unless otherwise noted, data presented in these graphs is typical of device operation at 25°C.

**PERFORMANCE DATA\***

**Typical Turn-On Time vs. Temperature**  
( $I_L=80\text{mA}$ )

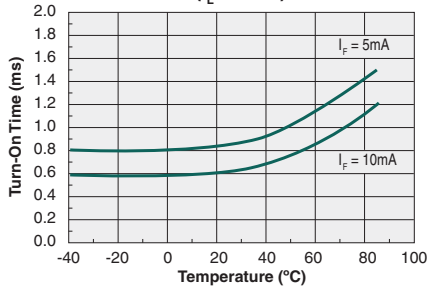

**Typical Turn-Off Time vs. Temperature**  
( $I_L=80\text{mA}$ )

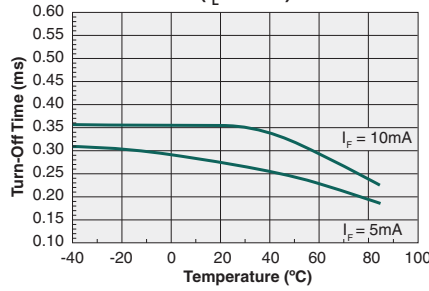

**Typical On-Resistance vs. Temperature**  
( $I_F=2\text{mA}$ ,  $I_L=600\text{mA}$ )

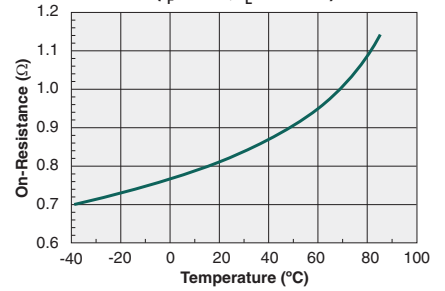

**Typical  $I_F$  for Switch Operation vs. Temperature**  
( $I_L=300\text{mA}$ )

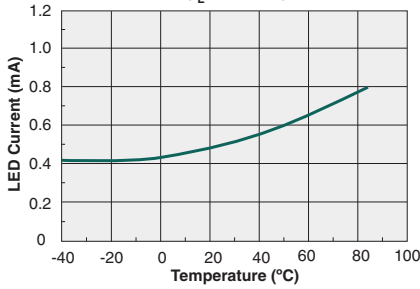

**Typical  $I_F$  for Switch Dropout vs. Temperature**  
( $I_L=300\text{mA}$ )

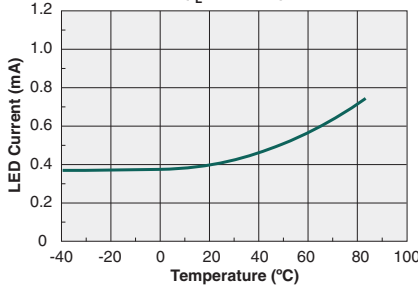

**Typical Load Current vs. Load Voltage**  
( $I_F=2\text{mA}$ )

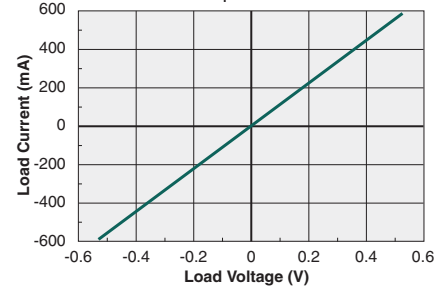

**Maximum Load Current vs. Temperature**  
( $I_F=2\text{mA}$ )

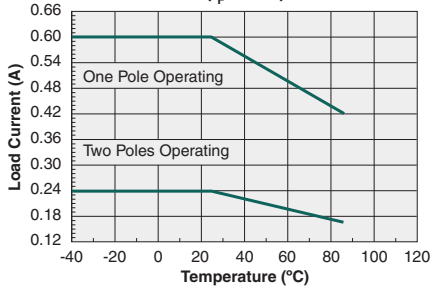

**Typical Blocking Voltage vs. Temperature**

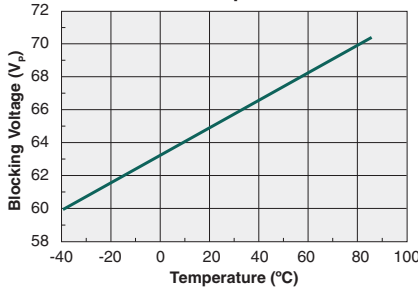

**Typical Leakage vs. Temperature Measured Across Pins 5&6, 7&8**  
( $V_p=60\text{V}$ )

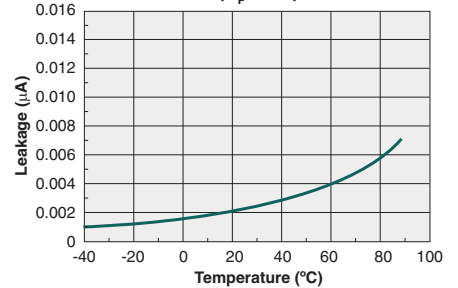

**Energy Rating Curve**

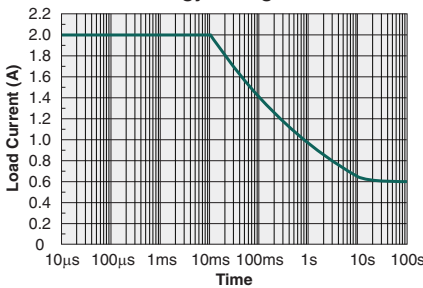

\*Unless otherwise noted, data presented in these graphs is typical of device operation at 25°C.

## Manufacturing Information

### Moisture Sensitivity



All plastic encapsulated semiconductor packages are susceptible to moisture ingress. IXYS Integrated Circuits classifies its plastic encapsulated devices for moisture sensitivity according to the latest version of the joint industry standard, **IPC/JEDEC J-STD-020**, in force at the time of product evaluation. We test all of our products to the maximum conditions set forth in the standard, and guarantee proper operation of our devices when handled according to the limitations and information in that standard as well as to any limitations set forth in the information or standards referenced below.

Failure to adhere to the warnings or limitations as established by the listed specifications could result in reduced product performance, reduction of operable life, and/or reduction of overall reliability.

This product carries a **Moisture Sensitivity Level (MSL)** classification as shown below, and should be handled according to the requirements of the latest version of the joint industry standard **IPC/JEDEC J-STD-033**.

Device	Moisture Sensitivity Level (MSL) Classification
PAA132S	MSL 1

### ESD Sensitivity



This product is ESD Sensitive, and should be handled according to the industry standard **JESD-625**.

### Soldering Profile

Provided in the table below is the **IPC/JEDEC J-STD-020** Classification Temperature ( $T_C$ ) and the maximum total dwell time ( $t_p$ ) in all reflow processes that the body temperature of these surface mount devices may be ( $T_C - 5$ )°C or greater. The device's body temperature must not exceed the Classification Temperature at any time during reflow soldering processes.

Device	Classification Temperature ( $T_C$ )	Dwell Time ( $t_p$ )	Max Reflow Cycles
PAA132S	250°C	30 seconds	3

For through-hole devices, the maximum pin temperature and maximum dwell time through all solder waves is provided in the table below. Dwell time is the interval beginning when the pins are initially immersed into the solder wave until they exit the solder wave. For multiple waves, the dwell time is from entering the first wave until exiting the last wave. During this time, pin temperatures must not exceed the maximum temperature given in the table below. Body temperature of the device must not exceed the limit shown in the table below at any time during the soldering process.

Device	Maximum Pin Temperature	Maximum Body Temperature	Maximum Dwell Time	Wave Cycles
PAA132	260°C	250°C	10 seconds*	1

\*Total cumulative duration of all waves.

### Board Wash

IXYS Integrated Circuits recommends the use of no-clean flux formulations. Board washing to reduce or remove flux residue following the solder reflow process is acceptable provided proper precautions are taken to prevent damage to the device. These precautions include but are not limited to: using a low pressure wash and providing a follow up bake cycle sufficient to remove any moisture trapped within the device due to the washing process. Due to the variability of the wash parameters used to clean the board, determination of the bake temperature and duration necessary to remove the moisture trapped within the package is the responsibility of the user (assembler). Cleaning or drying methods that employ ultrasonic energy may damage the device and should not be used. Additionally, the device must not be exposed to halide flux or solvents.



**Mechanical Dimensions**

**PAA132**

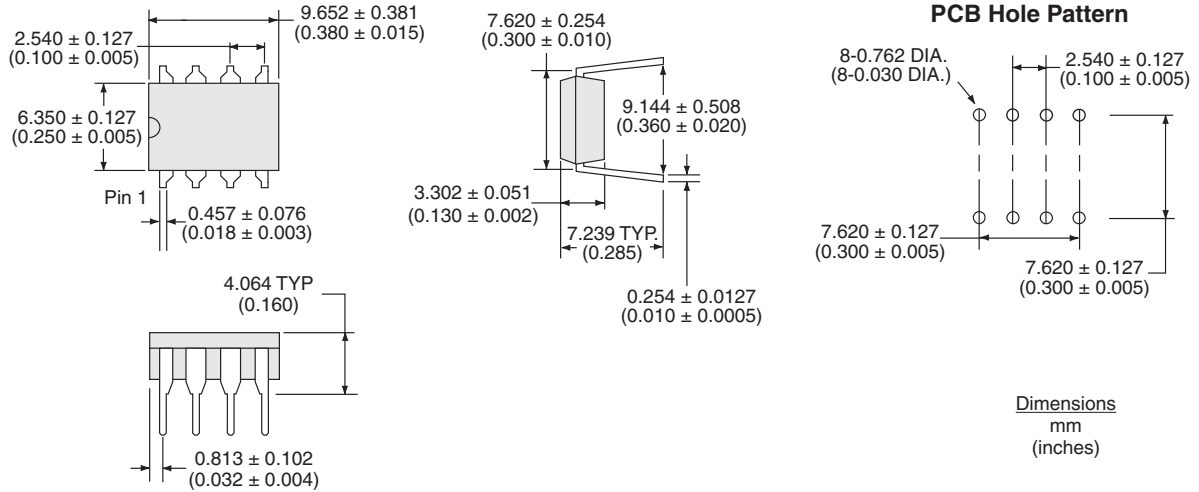

**PAA132S**

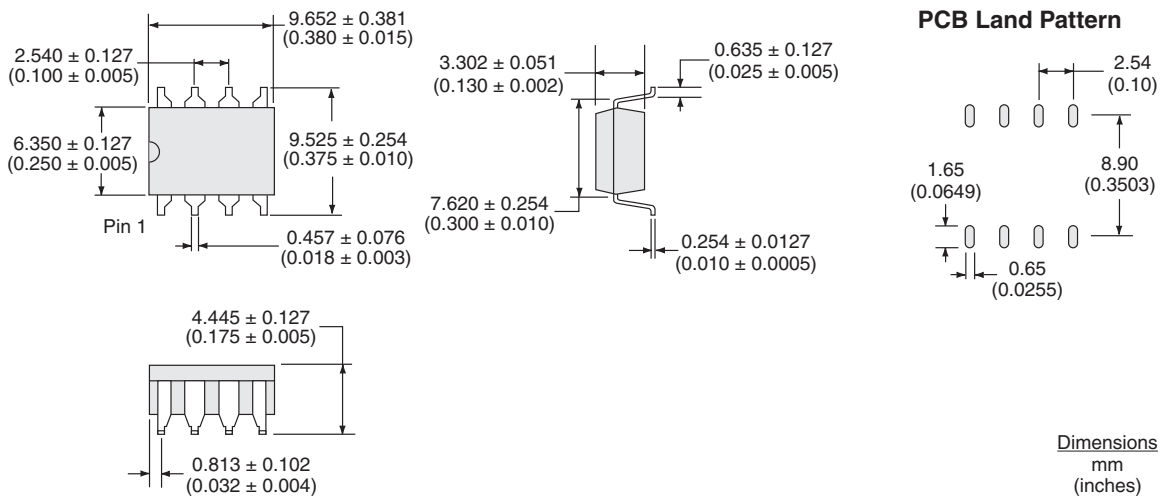

**PAA132STR Tape & Reel**

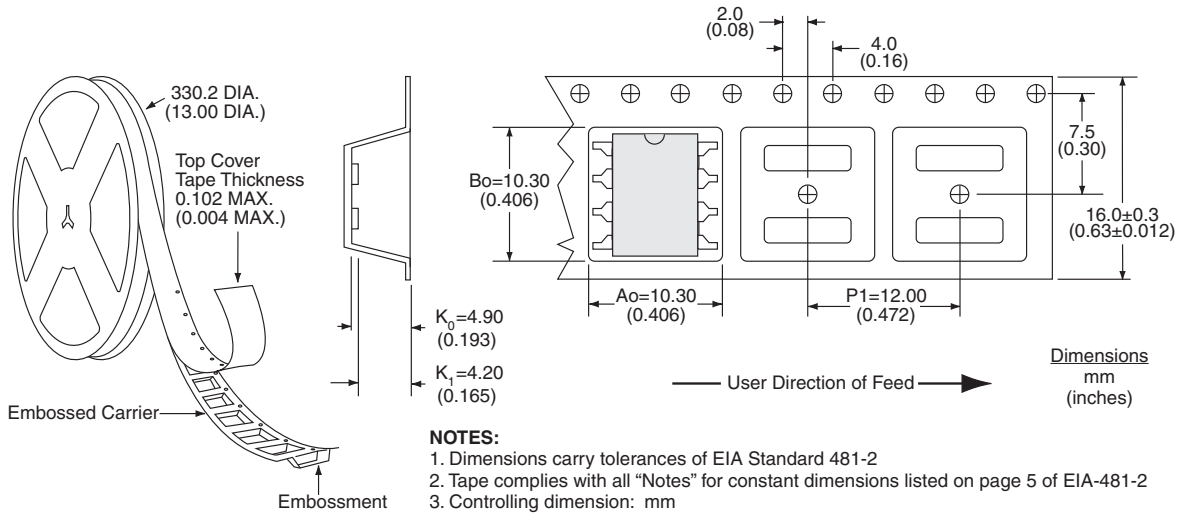

For additional information please visit our website at: <https://www.ixysic.com>