

# Fast Switching SCR T707\_\_30

300A Avg.  
(475 RMS)  
Up to 1400 Volts  
25-60  $\mu$ s

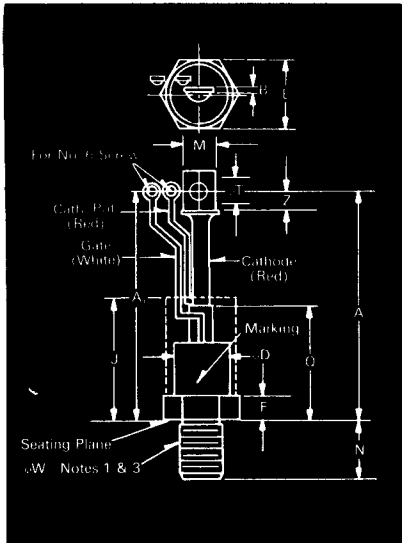

Symbol	Inches		Millimeters	
	Min.	Max.	Min.	Max.
A	9.76	10.00	247.90	254.00
A <sub>1</sub>	10.18	10.42	258.57	264.67
B	.063	.172	1.60	4.37
$\phi$ D		1.490		37.85
E	1.620	1.750	41.15	44.45
F	.430	.810	10.92	20.57
J	4.000		101.60	
M	.530	.755	13.46	19.18
N	1.04	1.08	26.42	27.43
Q		3.100		78.74
$\phi$ T	.330	.350	8.38	8.89
Z	.440		11.18	
$\phi$ W	¼-16 UNF-2A			

Creep Distance—1.76 in. min. (44.91 mm).  
Strike Distance—.81 in. min. (20.70 mm).  
(In accordance with NEMA standards.)  
Finish—Nickel Plate.

Approx. Weight—16 oz. (454 g).

1. Complete threads to extend to within 2½ threads of seating plane.
2. Angular orientation of terminals is undefined.
3. Pitch diameter of ¼-16 UNF-2A (coated) threads (ASA B1.1-1960).
4. Dimension "J" denotes seated height with leads bent at right angles.

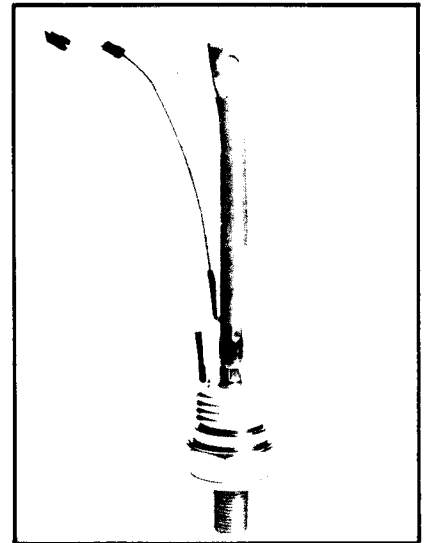

T70 Outline

### Features:

- Center fired di/damic gate
- High di/dt with soft gate control
- High frequency operation
- Sinusoidal waveform operation to 20 KHz
- Rectangular waveform operation to 20 KHz
- Low dynamic forward voltage drop
- Low switching losses at high frequency
- Westinghouse Lifetime Guarantee

### Applications:

- Inverters for UPS
- Induction heating
- AC motor drives
- Cycloconverters
- Choppers
- Crowbar

### Ordering Information

Type	Voltage		Current		Turn-off		Gate Current		Leads	
Code	V <sub>DRM</sub> and V <sub>RRM</sub> (V)	Code	I <sub>T(av)</sub> (A)	Code	t <sub>q</sub> $\mu$ sec	Code	I <sub>GT</sub> (ma)	Code	Case	Code
T707	100 200 300 400 500 600 700 800 900 1000 1100 1200 1400	01 02 03 04 05 06 07 08 09 10 11 12 14	300	30	25 30 40 50 60 15	4 5 6 7	150	4	T70	BY

### Example

Obtain optimum device performance for your application by selecting proper Order Code.

Type T 707 rated at 300A average with V<sub>DRM</sub> = 800V.  
I<sub>GT</sub> = 150 ma, t<sub>q</sub> = 40  $\mu$ sec and standard flex lead — order as

Type	Voltage	Current	Turn Off	Gate Current	Leads
T 7 0 7	0 8	3 0	4	4	B Y

# 300A Avg. (475 RMS) Up to 1400 Volts 25-60 $\mu$ s

# Fast Switching SCR T707\_30

## Voltage

Blocking State Maximums<sup>①</sup> ( $T_J = 125^\circ\text{C}$ )

Symbol	Value
Repetitive peak forward blocking voltage, V ... $V_{DRM}$	100 to 1400
Repetitive peak reverse voltage, V ... $V_{RRM}$	100 to 1400
Non-repetitive transient peak reverse voltage, V ... $V_{RSM}$	200 to 1500
Forward leakage current, mA peak ... $I_{DRM}$	30
Reverse leakage current, mA peak ... $I_{RRM}$	30

100	200	300	400	500	600	700	800	900	1000	1100	1200	1400	
100	200	300	400	500	600	700	800	900	1000	1100	1200	1400	
200	300	400	500	600	700	800	900	1000	1100	1200	1300	1500	
←							30	→					
←							30	→					

## Current

Conducting State Maximums  
( $T_J = 125^\circ\text{C}$ )

Symbol	T707_30
RMS forward current, A ... $I_T(\text{rms})$	475
Ave. forward current, A ... $I_T(\text{av})$	300
One-half cycle surge current <sup>②</sup> , A ... $I_{TSM}$	8000
$I^2t$ for fusing (for times $\geq 8.3$ ms) $\text{A}^2 \text{sec.}$ ... $I^2t_f$	265,000
Forward voltage drop at $I_{TM} = 625$ A and $T_J = 25^\circ\text{C}$ , V ... $V_{TM}$	1.45
Min. repetitive $di/dt$ , A/ $\mu\text{sec}$ ... $di/dt$	400

## Switching

( $T_J = 25^\circ\text{C}$ )

Symbol	Value
Max. turn-off time, $I_T = 400$ A, $T_J = 125^\circ\text{C}$ , $di/dt = 25$ A/ $\mu\text{sec}$ , reappplied $dv/dt = 20$ V/ $\mu\text{sec}$ linear to .8V DRM, $\mu\text{sec}$ ... $t_q$	25 to 60
Typ. turn-on-time, $I_T = 1000$ A, $V_D = 300$ V, $\mu\text{sec}$ ... $t_{on}$	3.0
Min. critical $dv/dt$ , exponential to $V_{DRM}$ , $T_J = 125^\circ\text{C}$ , V/ $\mu\text{sec}$ ... $dv/dt$	300
Min. $di/dt$ , non-repetitive, A/ $\mu\text{sec}$ ... $di/dt$	800

## Gate

Maximum Parameters  
( $T_J = 25^\circ\text{C}$ )

Symbol	Value
Gate current to trigger at $V_D = 12$ V, mA ... $I_{GT}$	150
Gate voltage to trigger at $V_D = 12$ V, V ... $V_{GT}$	3
Non-triggering gate voltage, $T_J = 125^\circ\text{C}$ , and rated $V_{DRM}$ , V ... $V_{GDM}$	0.15
Peak forward gate current, A ... $I_{GTM}$	4
Peak reverse gate voltage, V ... $V_{GRM}$	5
Peak gate power, Watts ... $P_{GM}$	16
Average gate power, Watts ... $P_{G(av)}$	3

## Thermal and Mechanical

Symbol	Value
Min., Max. oper. junction temp., $^\circ\text{C}$ ... $T_J$	-40 to +125
Min., Max. storage temp., $^\circ\text{C}$ ... $T_{stg}$	-40 to +15C
Max. mounting torque, in lb ...	360
Max. Thermal resistance <sup>③</sup>	
Junction to case, $^\circ\text{C}/\text{Watt}$ ... $R_{\theta JC}$	.10
Case to sink, lubricated, $^\circ\text{C}/\text{Watt}$ ... $R_{\theta CS}$	.05

- ① Consult recommended mounting procedures.
- ② Applies for zero or negative gate bias.
- ③ Per JEDEC RS-397, 5.2.2.1.
- ④ With recommended gate drive.
- ⑤ Higher  $dv/dt$  ratings available, consult factory.
- ⑥ Per JEDEC standard RS-397, 5.2.2.6.
- ⑦ For operation with antiparallel diode, consult factory.

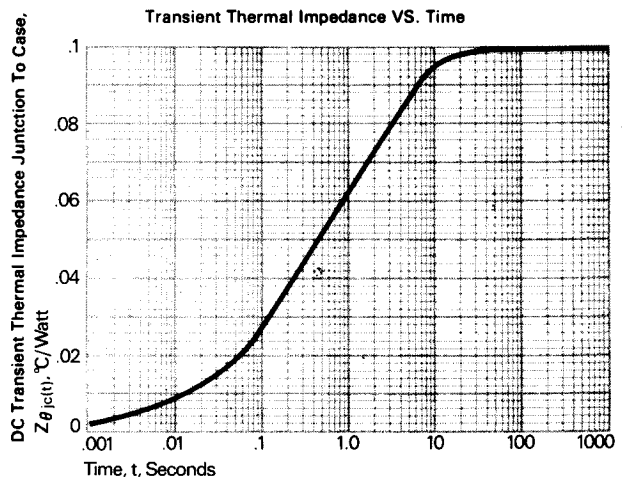
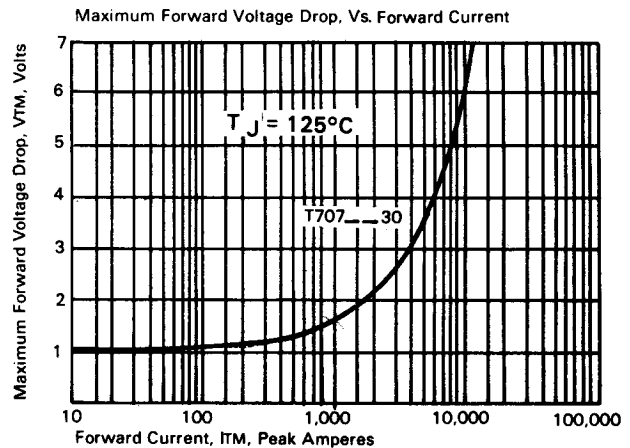

# Fast Switching SCR T707\_30

300A Avg.  
(475 RMS)  
Up to 1400 Volts  
25-60  $\mu$ s

## Sinusoidal Current Data

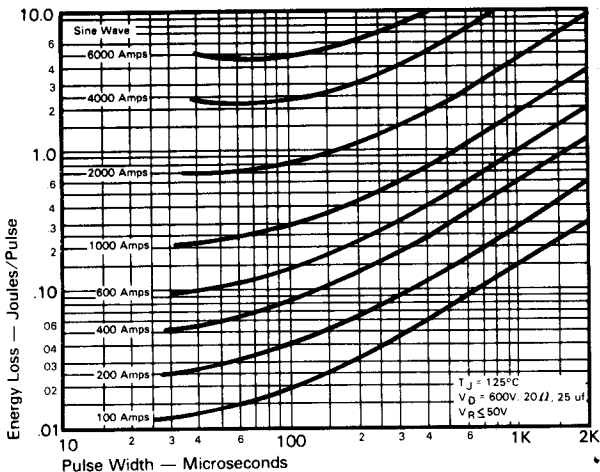

ENERGY PER PULSE FOR SINUSOIDAL PULSES

## Trapezoidal Wave Current Data

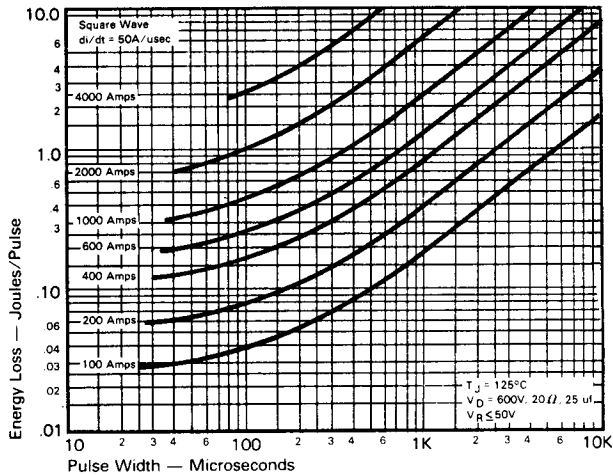

ENERGY PER PULSE FOR TRAPEZOIDAL PULSES  
( $di/dt = 50\text{A/usec}$ )

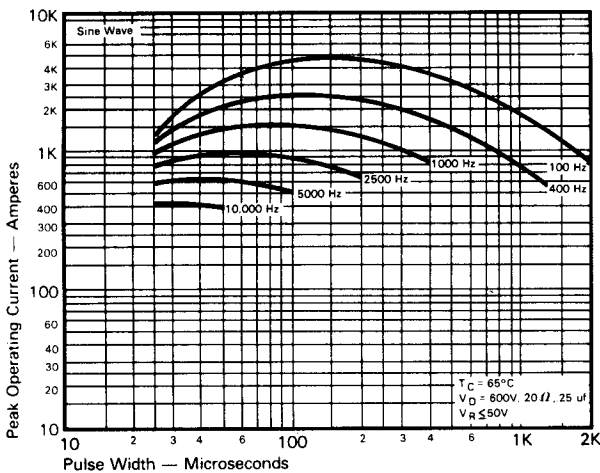

MAXIMUM ALLOWABLE PEAK ON-STATE CURRENT  
vs. PULSE WIDTH ( $T_C = 65^\circ\text{C}$ )

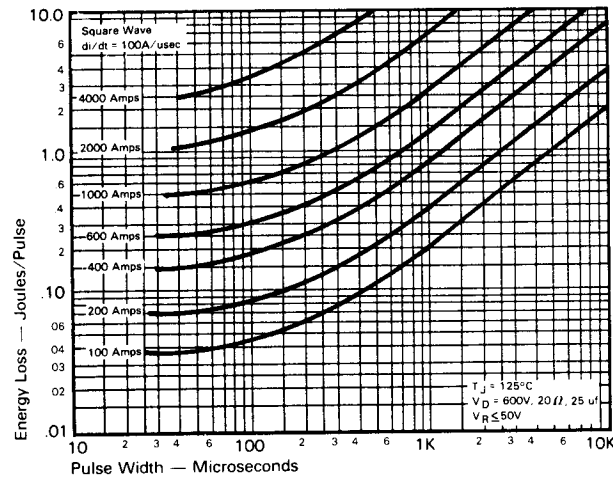

ENERGY PER PULSE FOR TRAPEZOIDAL PULSES  
( $di/dt = 100\text{A/usec}$ )

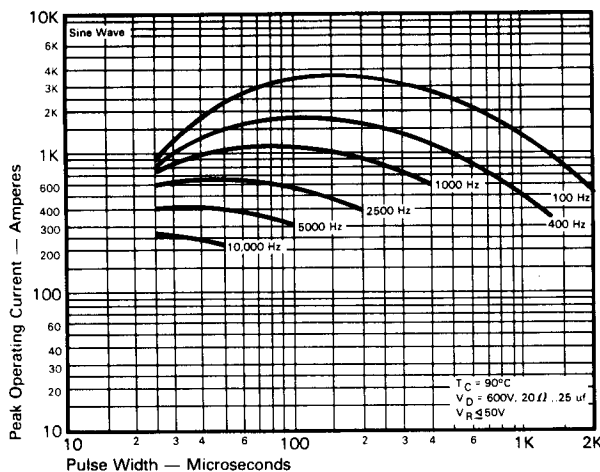

MAXIMUM ALLOWABLE PEAK ON-STATE CURRENT  
vs. PULSE WIDTH ( $T_C = 90^\circ\text{C}$ )

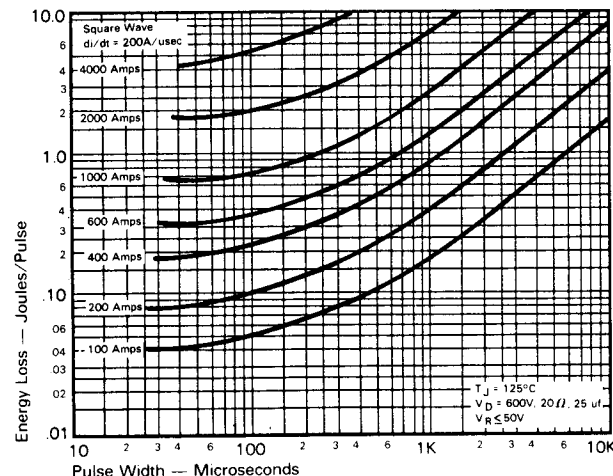

ENERGY PER PULSE FOR TRAPEZOIDAL PULSES  
( $di/dt = 200\text{A/usec}$ )

FAST SWITCHING  
THYRISTORS

**300A Avg.  
(475 RMS)  
Up to 1400 Volts  
25-60  $\mu$ s**

**Fast Switching  
SCR  
T707\_30**

**Trapezoidal Wave Current Data  
( $T_C = 65^\circ\text{C}$ )**

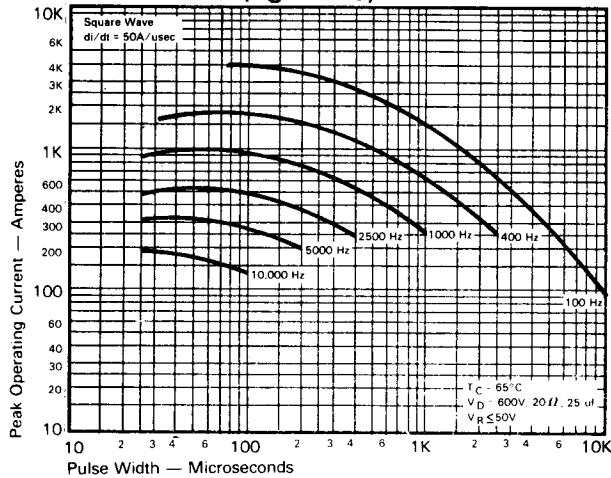

**MAXIMUM ALLOWABLE PEAK ON-STATE CURRENT vs. PULSE WIDTH ( $di/dt = 50A/usec$ )**

**Trapezoidal Wave Current Data  
( $T_C = 90^\circ\text{C}$ )**

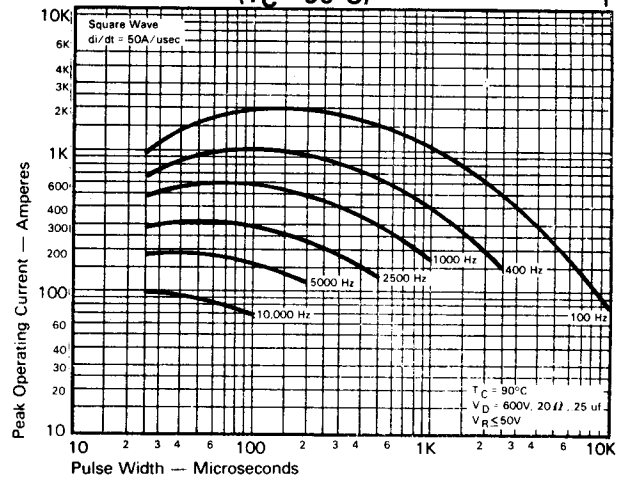

**MAXIMUM ALLOWABLE PEAK ON-STATE CURRENT vs. PULSE WIDTH ( $di/dt = 50A/usec$ )**

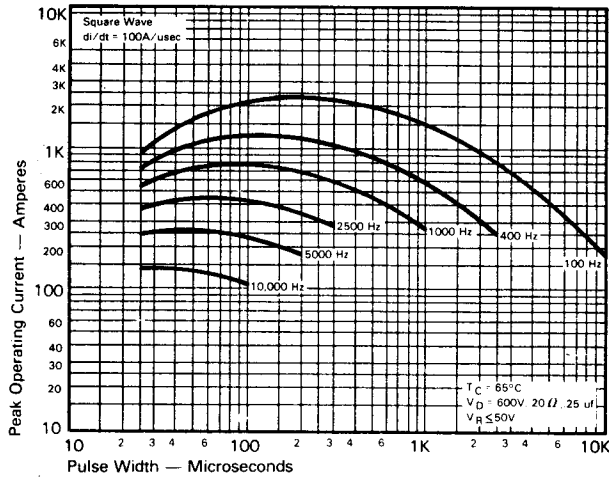

**MAXIMUM ALLOWABLE PEAK ON-STATE CURRENT vs. PULSE WIDTH ( $di/dt = 100A/usec$ )**

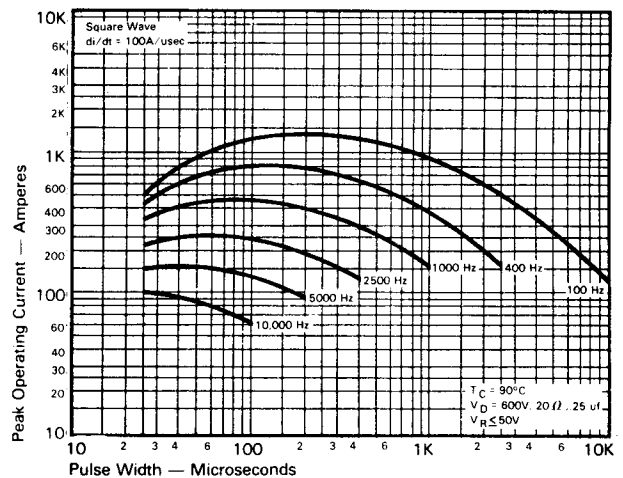

**MAXIMUM ALLOWABLE PEAK ON-STATE CURRENT vs. PULSE WIDTH ( $di/dt = 100A/usec$ )**

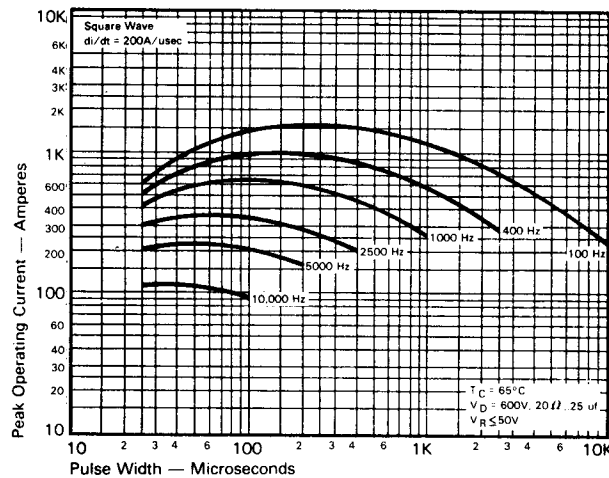

**MAXIMUM ALLOWABLE PEAK ON-STATE CURRENT vs. PULSE WIDTH ( $di/dt = 200A/usec$ )**

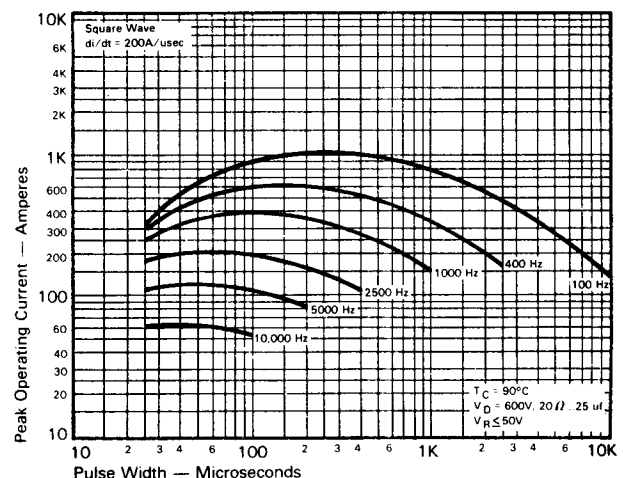

**MAXIMUM ALLOWABLE PEAK ON-STATE CURRENT vs. PULSE WIDTH ( $di/dt = 200A/usec$ )**

FAST SWITCHING THYRISTORS

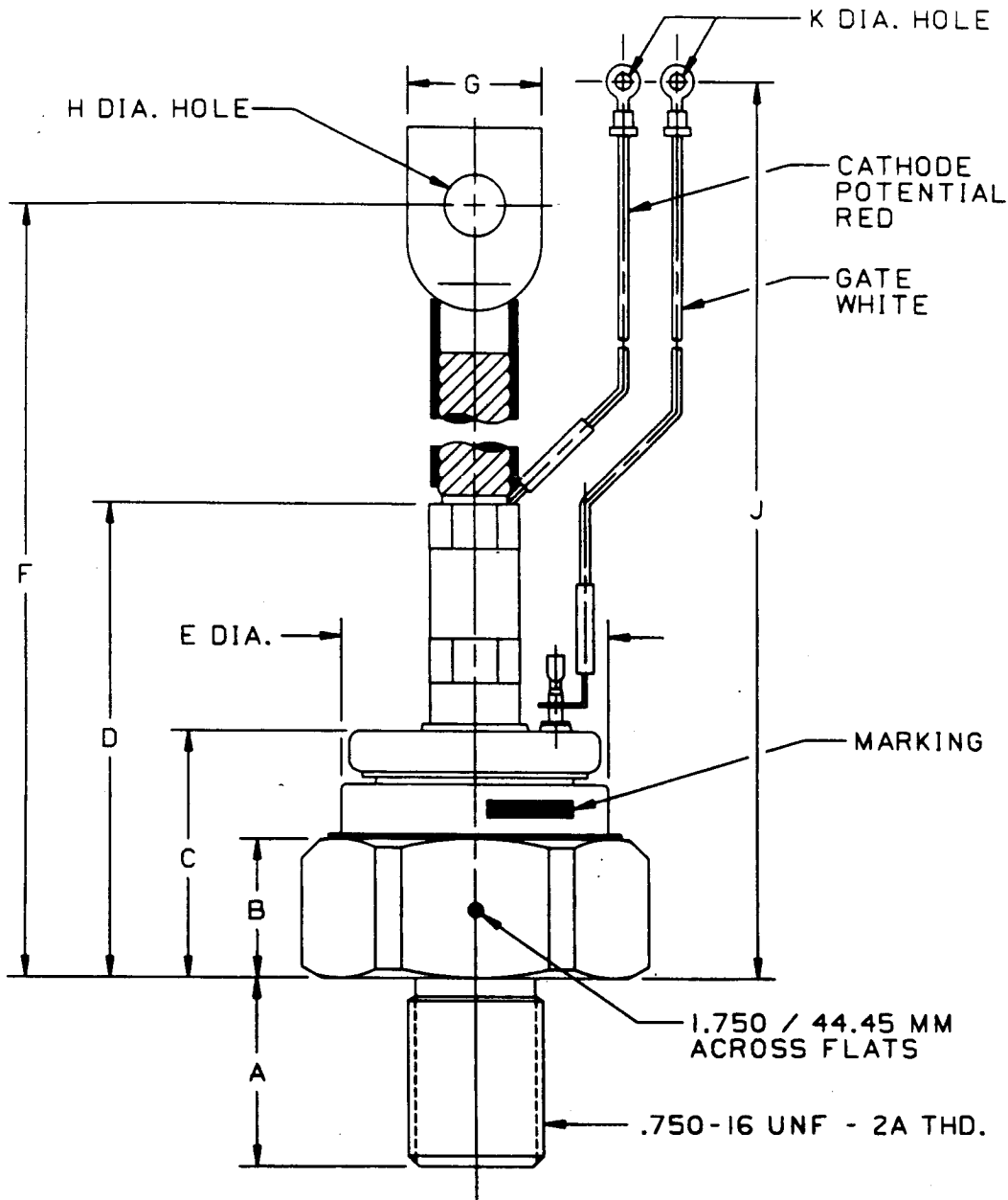

CASE NUMBER T70  
NOMINAL DIMENSIONS

STRIKE DISTANCE = .43 INCH / 10.9 MM MIN.  
CREEPAGE DISTANCE = .43 INCH / 10.9 MM MIN.

SYM.	A	B	C	D	E	F	G	H	J	K
INCHES	1.06	.78	1.41	2.74	1.49	9.66	.73	.343	10.06	.146
MM	26.9	19.8	35.8	69.6	37.8	245.4	18.5	8.71	255.5	3.71

ALL DIMENSIONS ARE REFERENCE