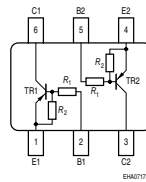
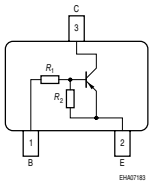

PNP Silicon Digital Transistor

- Switching circuit, inverter, interface circuit, driver circuit
- Built in bias resistor ($R_1 = 47\text{ k}\Omega$, $R_2 = 47\text{ k}\Omega$)
- BCR198S: Two internally isolated transistors with good matching in one multichip package
- BCR198S: For orientation in reel see package information below

**BCR198/F/L3
BCR198T/W**

Type	Marking	Pin Configuration						Package
BCR198	WRs	1=B	2=E	3=C	-	-	-	SOT23
BCR198F	WRs	1=B	2=E	3=C	-	-	-	TSFP-3
BCR198L3	WR	1=B	2=E	3=C	-	-	-	TSLP-3-4
BCR198S	WRs	1=E1	2=B1	3=C2	4=E2	5=B2	6=C1	SOT363
BCR198T	WR	1=B	2=E	3=C	-	-	-	SC75
BCR198W	WRs	1=B	2=E	3=C	-	-	-	SOT323

Maximum Ratings

Parameter	Symbol	Value	Unit
Collector-emitter voltage	V_{CEO}	50	V
Collector-base voltage	V_{CBO}	50	
Input forward voltage	$V_{i(fwd)}$	80	
Input reverse voltage	$V_{i(rev)}$	10	
Collector current	I_C	70	mA
Total power dissipation- BCR198, $T_S \leq 102^\circ\text{C}$ BCR198F, $T_S \leq 128^\circ\text{C}$ BCR198L3, $T_S \leq 135^\circ\text{C}$ BCR198S, $T_S \leq 115^\circ\text{C}$ BCR198T, $T_S \leq 109^\circ\text{C}$ BCR198W, $T_S \leq 124^\circ\text{C}$	P_{tot}	200 250 250 250 250 250	mW
Junction temperature	T_j	150	°C
Storage temperature	T_{stg}	-65 ... 150	

Thermal Resistance

Parameter	Symbol	Value	Unit
Junction - soldering point ¹⁾	R_{thJS}		K/W
BCR198		≤ 240	
BCR198F		≤ 90	
BCR198L3		≤ 60	
BCR198S		≤ 140	
BCR198T		≤ 165	
BCR198W		≤ 105	

¹⁾For calculation of R_{thJA} please refer to Application Note Thermal Resistance

Electrical Characteristics at $T_A = 25^\circ\text{C}$, unless otherwise specified

Parameter	Symbol	Values			Unit
		min.	typ.	max.	
DC Characteristics					
Collector-emitter breakdown voltage $I_C = 100 \mu\text{A}, I_B = 0$	$V_{(BR)CEO}$	50	-	-	V
Collector-base breakdown voltage $I_C = 10 \mu\text{A}, I_E = 0$	$V_{(BR)CBO}$	50	-	-	
Collector-base cutoff current $V_{CB} = 40 \text{ V}, I_E = 0$	I_{CBO}	-	-	100	nA
Emitter-base cutoff current $V_{EB} = 10 \text{ V}, I_C = 0$	I_{EBO}	-	-	164	μA
DC current gain ¹⁾ $I_C = 5 \text{ V}, V_{CE} = 5 \text{ V}$	h_{FE}	70	-	-	-
Collector-emitter saturation voltage ¹⁾ $I_C = 10 \text{ mA}, I_B = 0.5 \text{ mA}$	V_{CEsat}	-	-	0.3	V
Input off voltage $I_C = 100 \mu\text{A}, V_{CE} = 5 \text{ V}$	$V_{i(off)}$	0.8	-	1.5	
Input on voltage $I_C = 2 \text{ mA}, V_{CE} = 0.3 \text{ V}$	$V_{i(on)}$	1	-	3	
Input resistor	R_1	32	47	62	$\text{k}\Omega$
Resistor ratio	R_1/R_2	0.9	1	1.1	-
AC Characteristics					
Transition frequency $I_C = 10 \text{ mA}, V_{CE} = 5 \text{ V}, f = 100 \text{ MHz}$	f_T	-	190	-	MHz
Collector-base capacitance $V_{CB} = 10 \text{ V}, f = 1 \text{ MHz}$	C_{cb}	-	3	-	pF

¹Pulse test: $t < 300 \mu\text{s}$; $D < 2\%$

DC current gain $h_{FE} = f(I_C)$

$V_{CE} = 5\text{ V}$ (common emitter configuration)

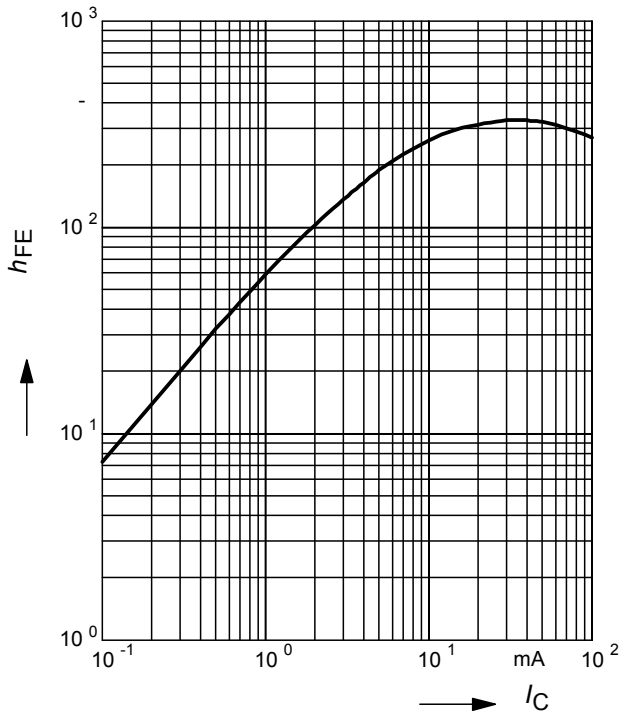

Collector-emitter saturation voltage

$V_{CEsat} = f(I_C), h_{FE} = 20$

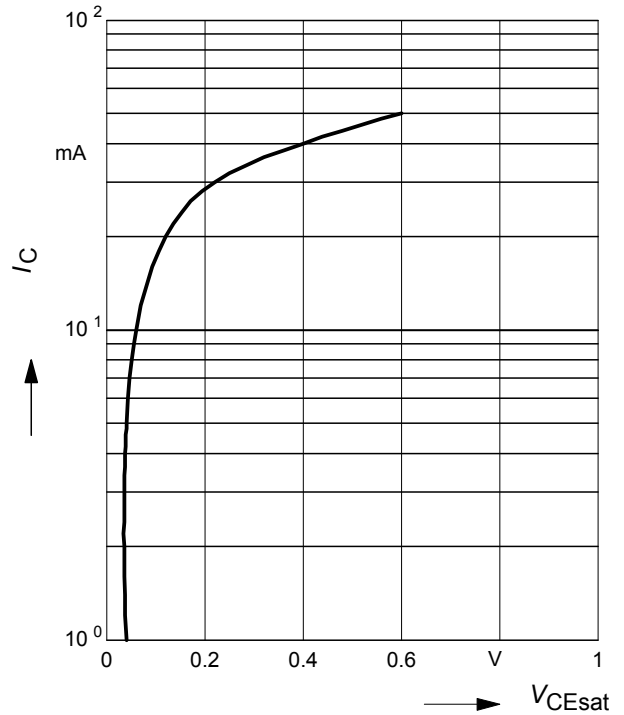

Input on Voltage $V_{i(on)} = f(I_C)$

$V_{CE} = 0.3\text{ V}$ (common emitter configuration)

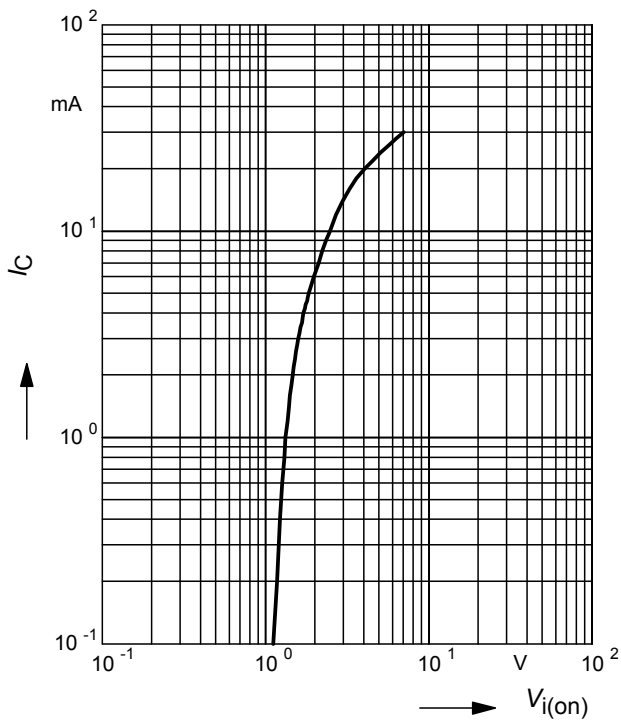

Input off voltage $V_{i(off)} = f(I_C)$

$V_{CE} = 5\text{ V}$ (common emitter configuration)

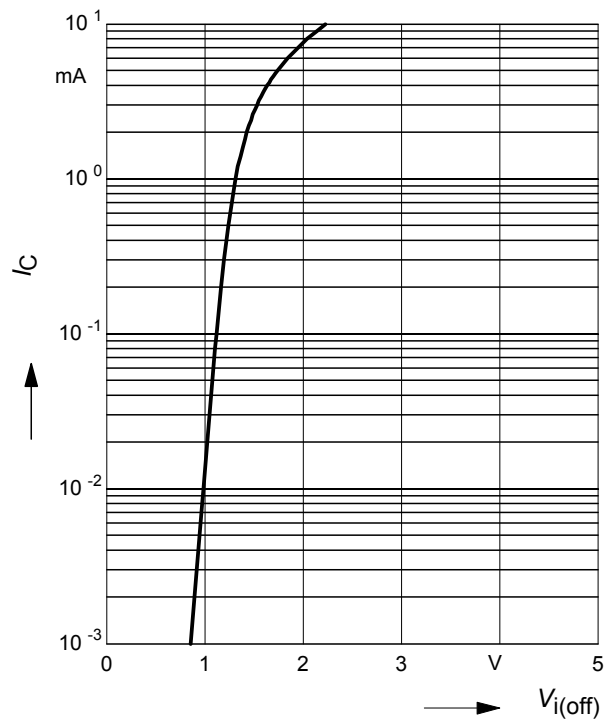

Total power dissipation $P_{tot} = f(T_S)$

BCR198



Total power dissipation $P_{tot} = f(T_S)$

BCR198F



Total power dissipation $P_{tot} = f(T_S)$

BCR198L3

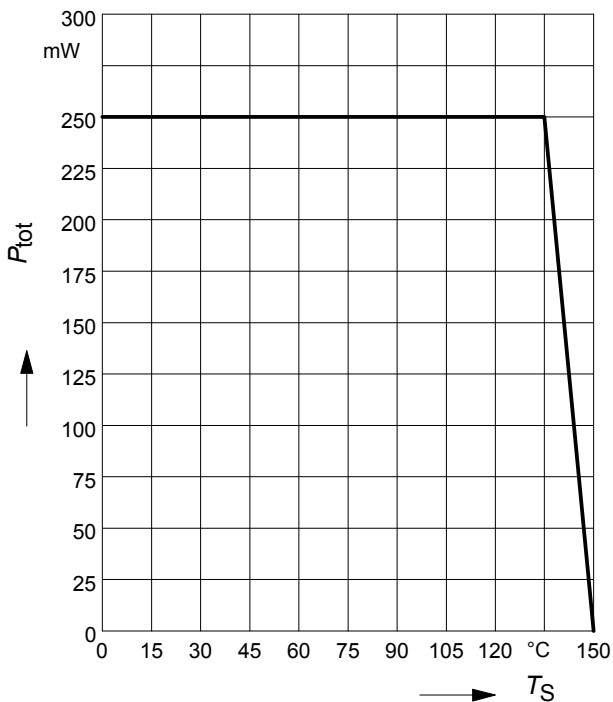

Total power dissipation $P_{tot} = f(T_S)$

BCR198S

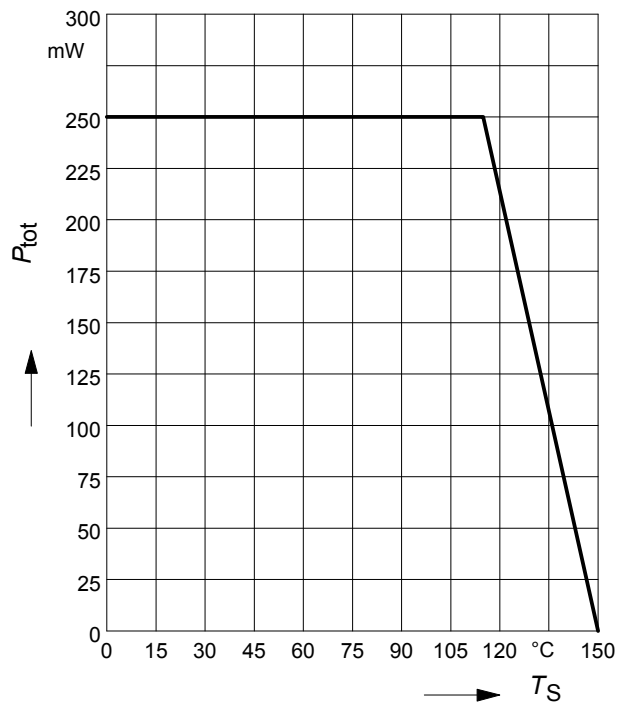

Total power dissipation $P_{tot} = f(T_S)$

BCR198T

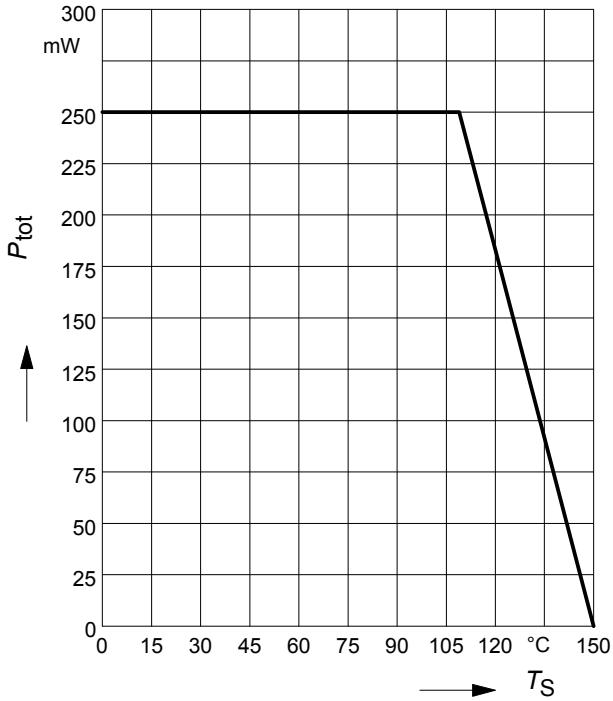

Total power dissipation $P_{tot} = f(T_S)$

BCR198W

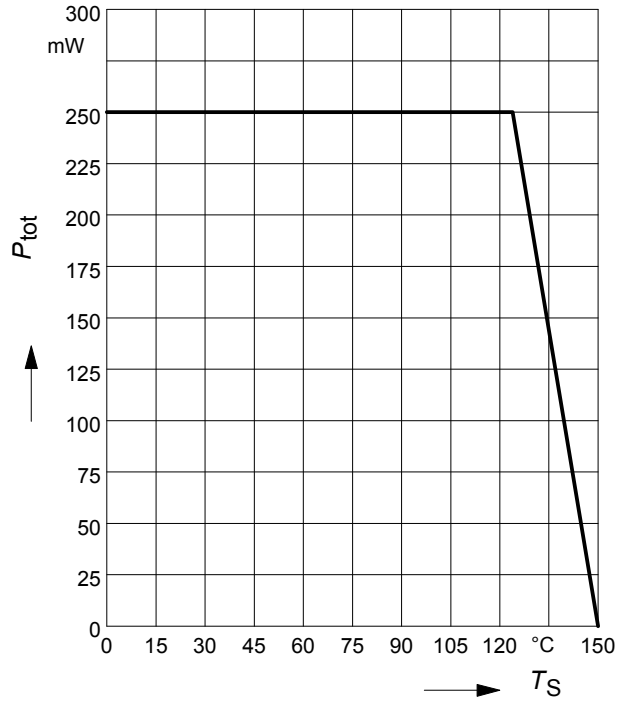

Permissible Pulse Load $R_{thJS} = f(t_p)$

BCR198

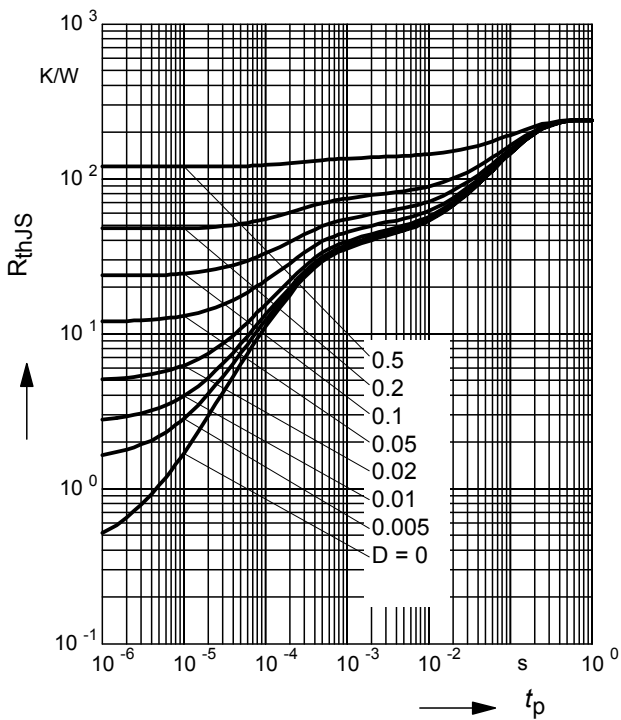

Permissible Pulse Load

$P_{totmax}/P_{totDC} = f(t_p)$

BCR198

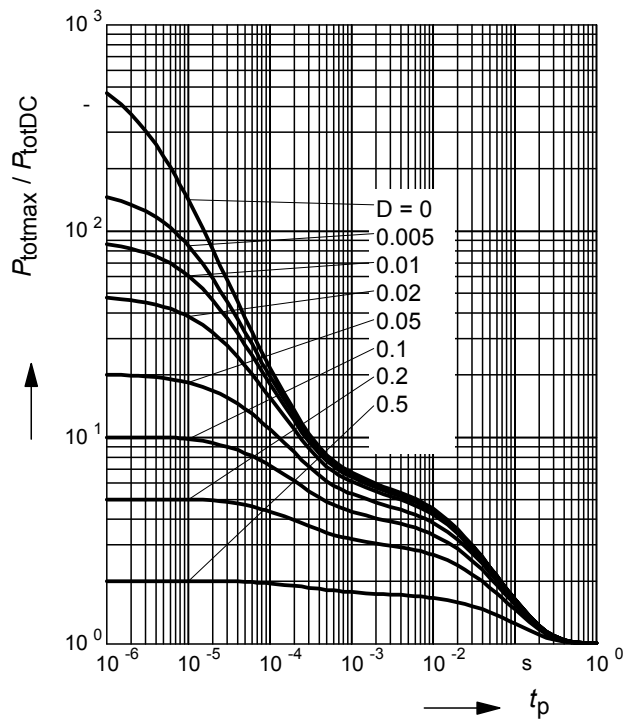

Permissible Puls Load $R_{thJS} = f(t_p)$

BCR198F

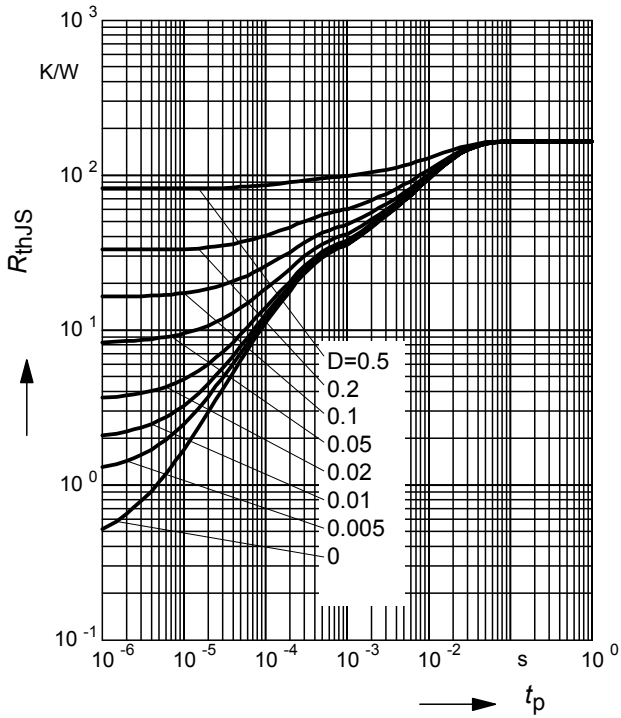

Permissible Pulse Load

$P_{totmax}/P_{totDC} = f(t_p)$

BCR198F



Permissible Puls Load $R_{thJS} = f(t_p)$

BCR198L3

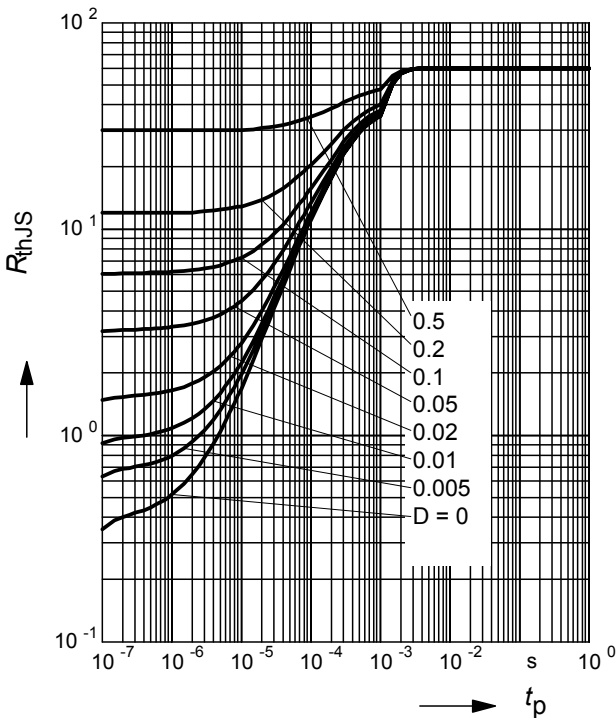

Permissible Pulse Load

$P_{totmax}/P_{totDC} = f(t_p)$

BCR198L3

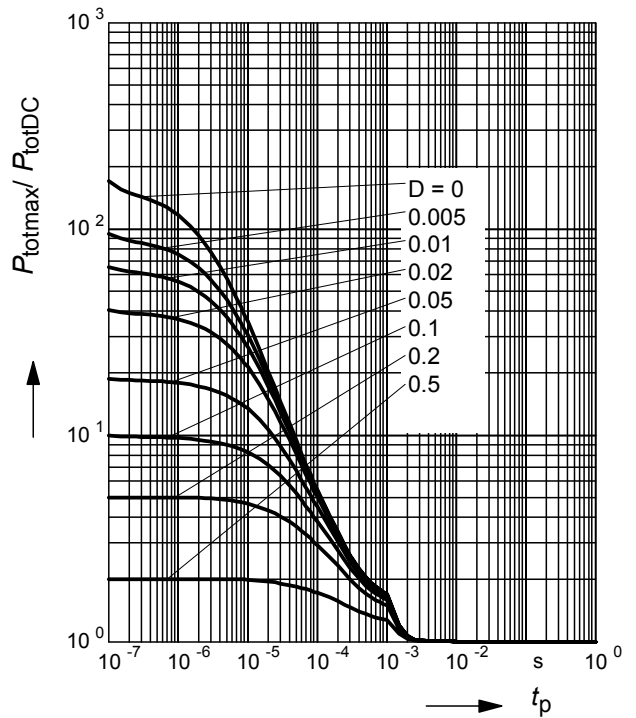

Permissible Puls Load $R_{thJS} = f(t_p)$

BCR198S

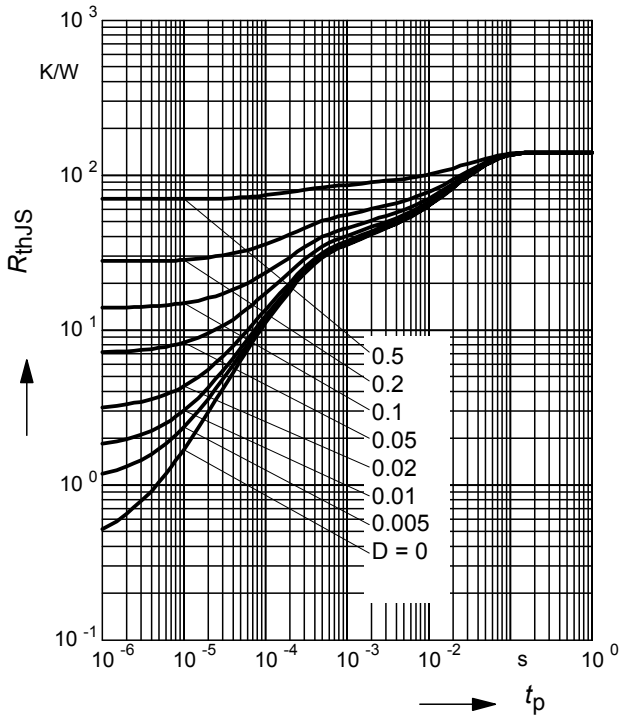

Permissible Pulse Load

$P_{totmax}/P_{totDC} = f(t_p)$

BCR198S

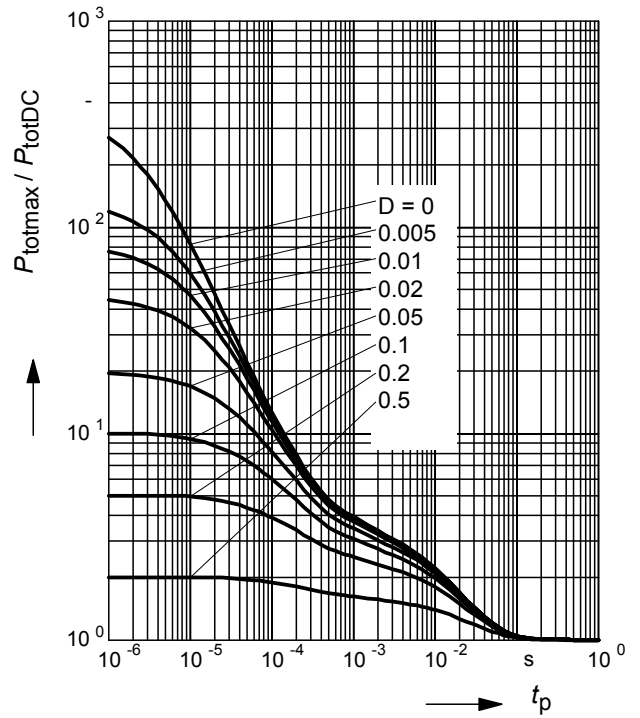

Permissible Puls Load $R_{thJS} = f(t_p)$

BCR198T

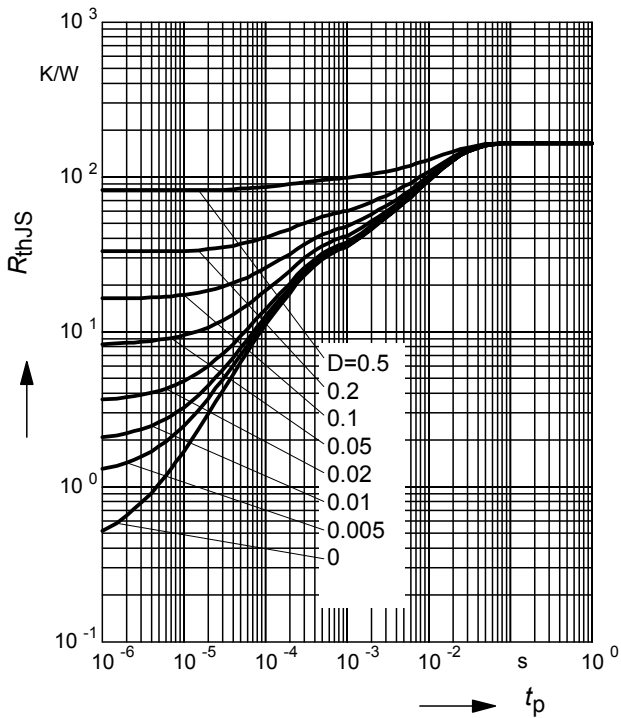

Permissible Pulse Load

$P_{totmax}/P_{totDC} = f(t_p)$

BCR198T

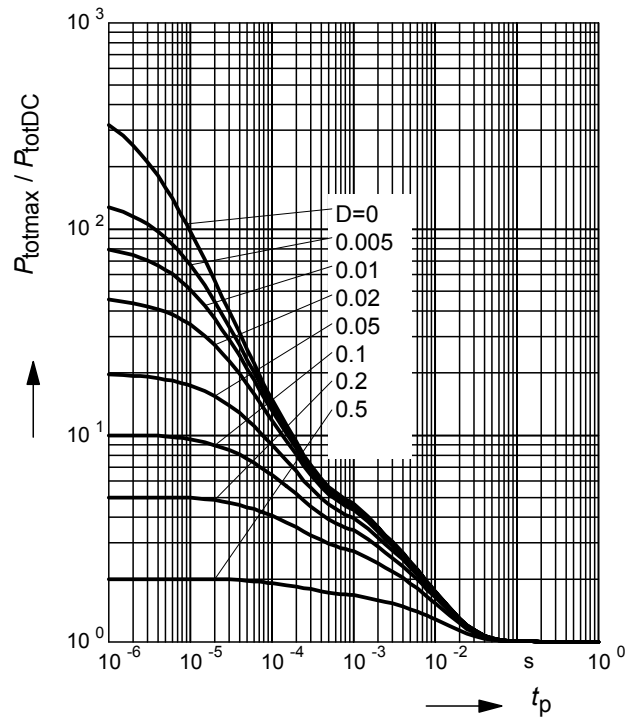

Permissible Puls Load $R_{thJS} = f(t_p)$

BCR133W

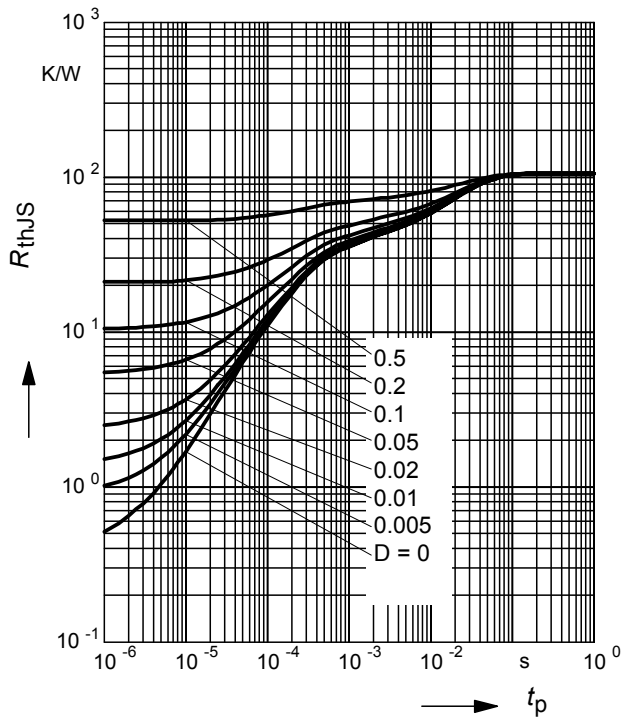

Permissible Pulse Load

$P_{totmax}/P_{totDC} = f(t_p)$

BCR198W

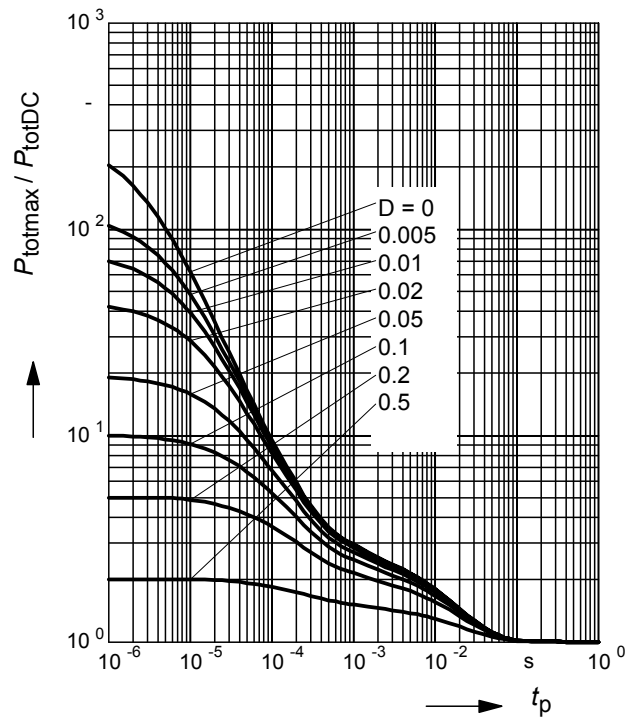

Package Outline

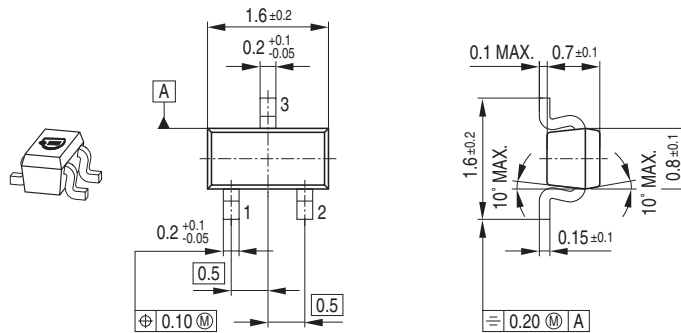

Foot Print

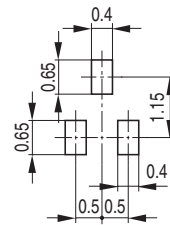

Marking Layout (Example)

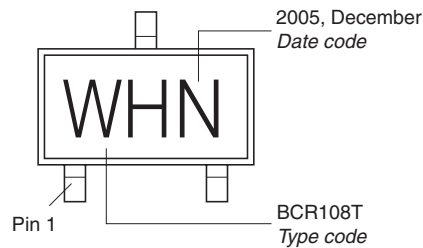

Standard Packing

Reel ϕ 180 mm = 3.000 Pieces/Reel
 Reel ϕ 330 mm = 10.000 Pieces/Reel

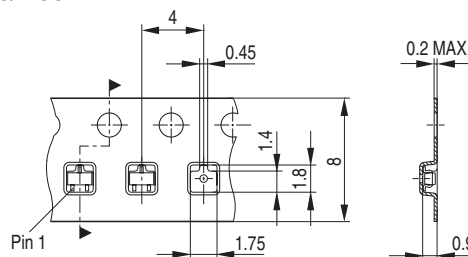

Date Code marking for discrete packages with one digit (SCD80, SC79, SC75¹⁾) CES-Code

Month	2003	2004	2005	2006	2007	2008	2009	2010	2011	2012	2013	2014
01	a	p	A	P	a	p	A	P	a	p	A	P
02	b	q	B	Q	b	q	B	Q	b	q	B	Q
03	c	r	C	R	c	r	C	R	c	r	C	R
04	d	s	D	S	d	s	D	S	d	s	D	S
05	e	t	E	T	e	t	E	T	e	t	E	T
06	f	u	F	U	f	u	F	U	f	u	F	U
07	g	v	G	V	g	v	G	V	g	v	G	V
08	h	x	H	X	h	x	H	X	h	x	H	X
09	j	y	J	Y	j	y	J	Y	j	y	J	Y
10	k	z	K	Z	k	z	K	Z	k	z	K	Z
11	l	2	L	4	l	2	L	4	l	2	L	4
12	n	3	N	5	n	3	N	5	n	3	N	5

1) New Marking Layout for SC75, implemented at October 2005.

Package Outline

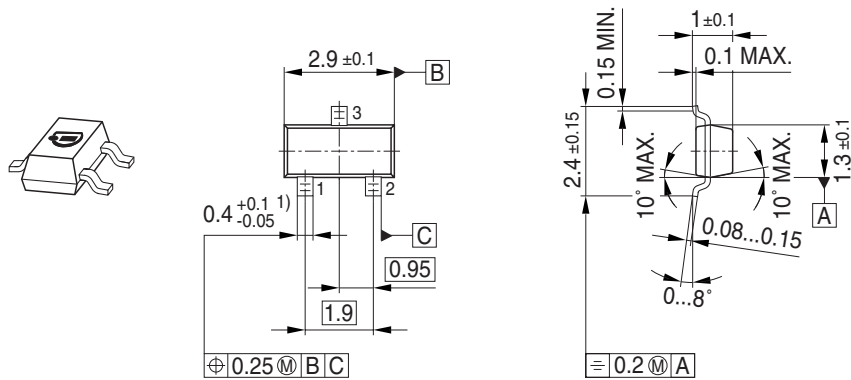

1) Lead width can be 0.6 max. in dambar area

Foot Print

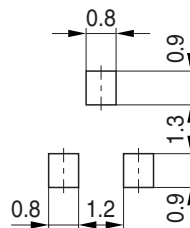

Marking Layout (Example)

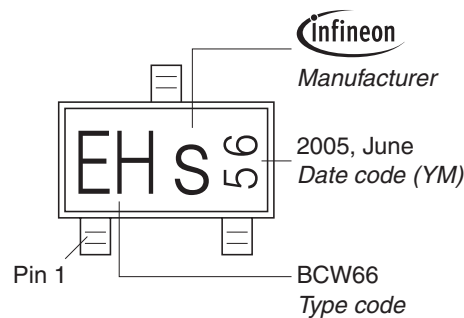

Standard Packing

Reel \varnothing 180 mm = 3.000 Pieces/Reel
 Reel \varnothing 330 mm = 10.000 Pieces/Reel

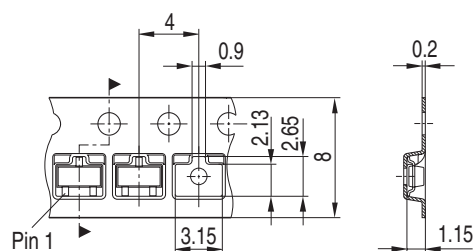

Package Outline

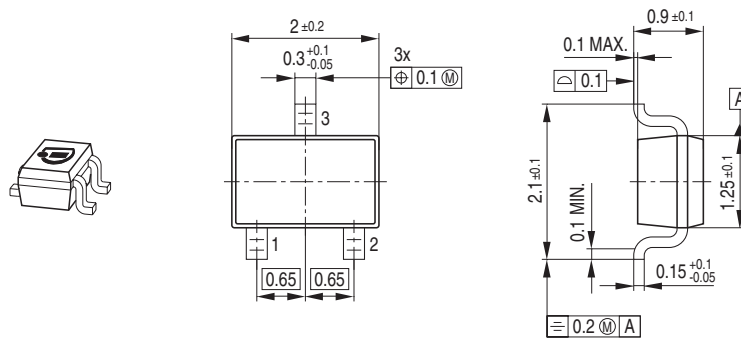

Foot Print

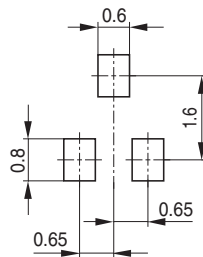

Marking Layout (Example)

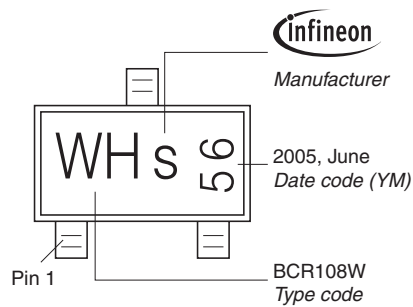

Standard Packing

Reel \varnothing 180 mm = 3.000 Pieces/Reel
 Reel \varnothing 330 mm = 10.000 Pieces/Reel

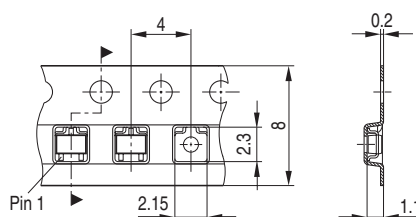

Package Outline

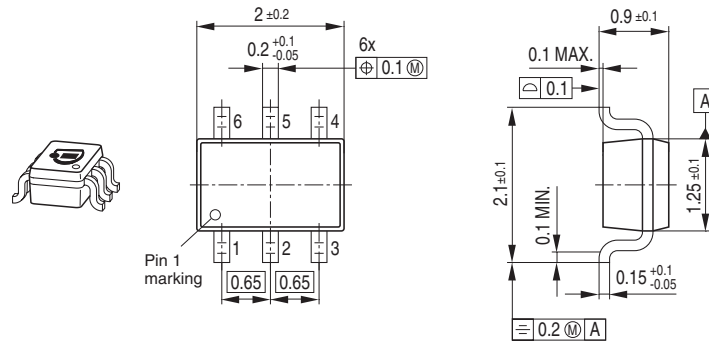

Foot Print

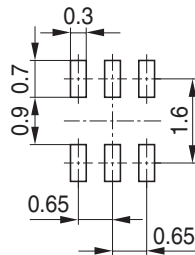

Marking Layout (Example)

Small variations in positioning of Date code, Type code and Manufacture are possible.

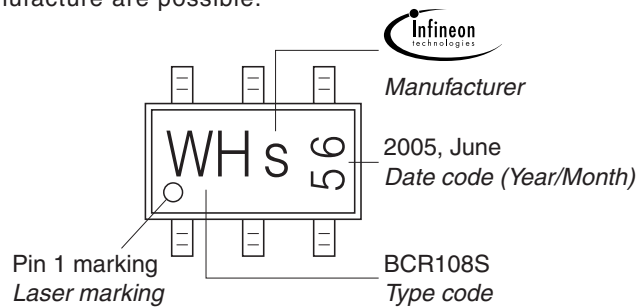

Standard Packing

Reel \varnothing 180 mm = 3.000 Pieces/Reel
 Reel \varnothing 330 mm = 10.000 Pieces/Reel

For symmetric types no defined Pin 1 orientation in reel.

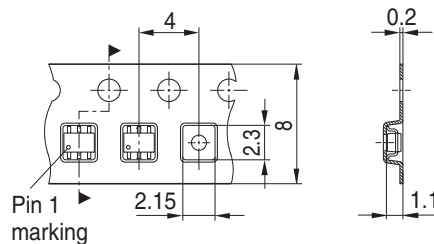

Package Outline

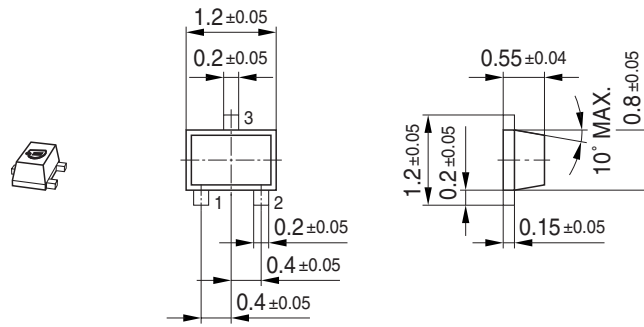

Foot Print

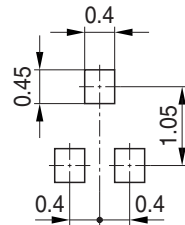

Marking Layout (Example)

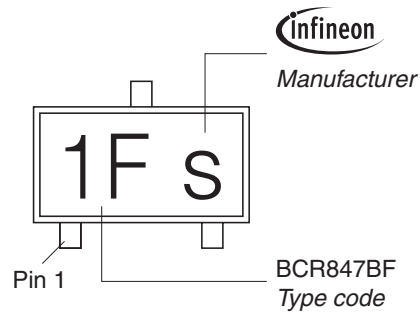

Standard Packing

Reel ø180 mm = 3.000 Pieces/Reel
 Reel ø330 mm = 10.000 Pieces/Reel

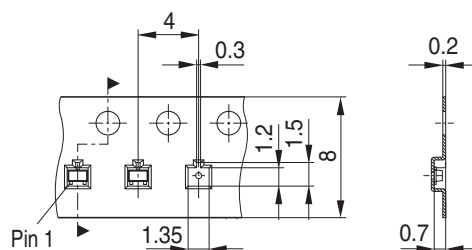

Package Outline

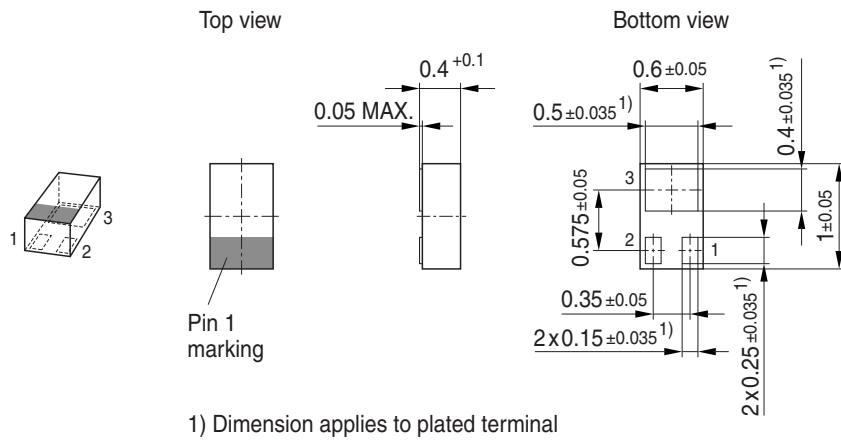

Foot Print

For board assembly information please refer to Infineon website "Packages"

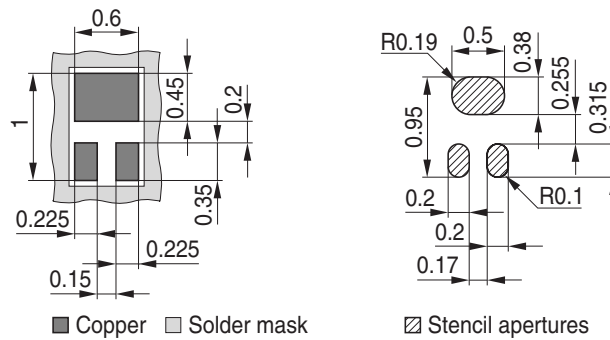

Marking Layout

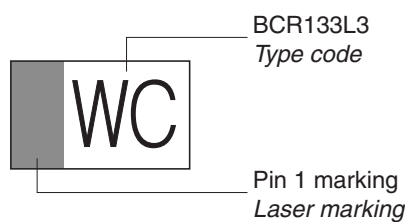

Standard Packing

Reel ø180 mm = 15.000 Pieces/Reel

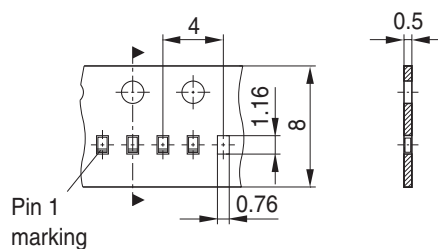

Edition 2006-02-01
Published by
Infineon Technologies AG
81726 München, Germany
© Infineon Technologies AG 2006.
All Rights Reserved.

Attention please!

The information given in this dokument shall in no event be regarded as a guarantee of conditions or characteristics ("Beschaffenheitsgarantie"). With respect to any examples or hints given herein, any typical values stated herein and/or any information regarding the application of the device, Infineon Technologies hereby disclaims any and all warranties and liabilities of any kind, including without limitation warranties of non-infringement of intellectual property rights of any third party.

Information

For further information on technology, delivery terms and conditions and prices please contact your nearest Infineon Technologies Office (www.infineon.com).

Warnings

Due to technical requirements components may contain dangerous substances. For information on the types in question please contact your nearest Infineon Technologies Office.

Infineon Technologies Components may only be used in life-support devices or systems with the express written approval of Infineon Technologies, if a failure of such components can reasonably be expected to cause the failure of that life-support device or system, or to affect the safety or effectiveness of that device or system.

Life support devices or systems are intended to be implanted in the human body, or to support and/or maintain and sustain and/or protect human life. If they fail, it is reasonable to assume that the health of the user or other persons may be endangered.