

# BAT15-03W

## Single silicon RF Schottky diode



Order now



Technical documents



Simulation



Support

## Product description

This Infineon RF Schottky diode is a silicon low barrier N-type device with an integrated guard ring on-chip for over-voltage protection. Its low barrier height, low forward voltage and low junction capacitance make BAT15-03W a suitable choice for mixer and detector functions in applications which frequencies are as high as 12 GHz.



## Feature list

- Low inductance  $L_S = 1.8$  nH (typical)
- Low capacitance  $C = 0.28$  pF (typical) at 1 MHz
- Industry standard SOD323 package (2.5 mm x 1.25 mm x 0.9 mm)
- Pb-free, RoHS compliant and halogen-free

## Product validation

Qualified for industrial applications according to the relevant tests of JEDEC47/20/22.

## Potential applications

For mixers and detectors in:

- Sensor interfaces of security systems
- Telematic systems
- Compensators
- Radar systems for industrial use

## Device information



**Table 1** Part information

Product name / Ordering code	Package	Pin configuration	Marking	Pieces/Reel
BAT15-03W / BAT1503WE6327HTSA1	SOD323	Single, with leads	white P	3 k

**Attention:** *ESD (Electrostatic discharge) sensitive device, observe handling precautions!*

**Table of contents**

**Table of contents**

	<b>Product description</b> .....	1
	<b>Feature list</b> .....	1
	<b>Product validation</b> .....	1
	<b>Potential applications</b> .....	1
	<b>Device information</b> .....	1
	<b>Table of contents</b> .....	2
<b>1</b>	<b>Absolute maximum ratings</b> .....	2
<b>2</b>	<b>Electrical performance in test fixture</b> .....	3
2.1	Electrical characteristics .....	3
2.2	Characteristic curves .....	3
<b>3</b>	<b>Thermal characteristics</b> .....	5
<b>4</b>	<b>Package information SOD323</b> .....	7
	<b>Revision history</b> .....	8
	<b>Disclaimer</b> .....	9

**1 Absolute maximum ratings**

**Table 2 Absolute maximum ratings at  $T_A = 25\text{ °C}$ , unless otherwise specified**

Parameter	Symbol	Values		Unit	Note or test condition
		Min.	Max.		
Diode reverse voltage	$V_R$	–	4	V	
Forward current	$I_F$	–	110	mA	
Total power dissipation	$P_{TOT}$	–	100	mW	$T_S \leq 78\text{ °C}$ <sup>1)</sup>
Junction temperature	$T_J$	–	150	°C	
Operating temperature	$T_{OP}$	-55	150		
Storage temperature	$T_{STG}$	-55	150		

**Attention:** *Stresses above the maximum values listed here may cause permanent damage to the device. Exposure to absolute maximum rating conditions for extended periods may affect device reliability. Exceeding only one of these values may cause irreversible damage to the component.*

<sup>1</sup>  $T_S$  is the soldering point temperature.

**Electrical performance in test fixture**

**2 Electrical performance in test fixture**

**2.1 Electrical characteristics**

**Table 3** Electrical characteristics at  $T_A = 25\text{ }^\circ\text{C}$ , unless otherwise specified

Parameter	Symbol	Values			Unit	Note or test condition
		Min.	Typ.	Max.		
Breakdown voltage	$V_{BR}$	4	–	–	V	$I_R = 100\text{ }\mu\text{A}$
Reverse current	$I_R$	–	–	5	$\mu\text{A}$	$V_R = 1\text{ V}$
Forward voltage	$V_F$	0.16	0.25	0.32	V	$I_F = 1\text{ mA}$
		0.25	0.35	0.41		$I_F = 10\text{ mA}$
Differential forward resistance	$R_F$	–	5.8	–	$\Omega$	$I_F = 10\text{ mA} / 50\text{ mA}$ <sup>1)</sup>
Capacitance	$C$	–	0.28	0.35	pF	$V_R = 0\text{ V}, f = 1\text{ MHz}$
Inductance	$L_S$	–	1.8	–	nH	

**2.2 Characteristic curves**

At  $T_A = 25\text{ }^\circ\text{C}$ , unless otherwise specified

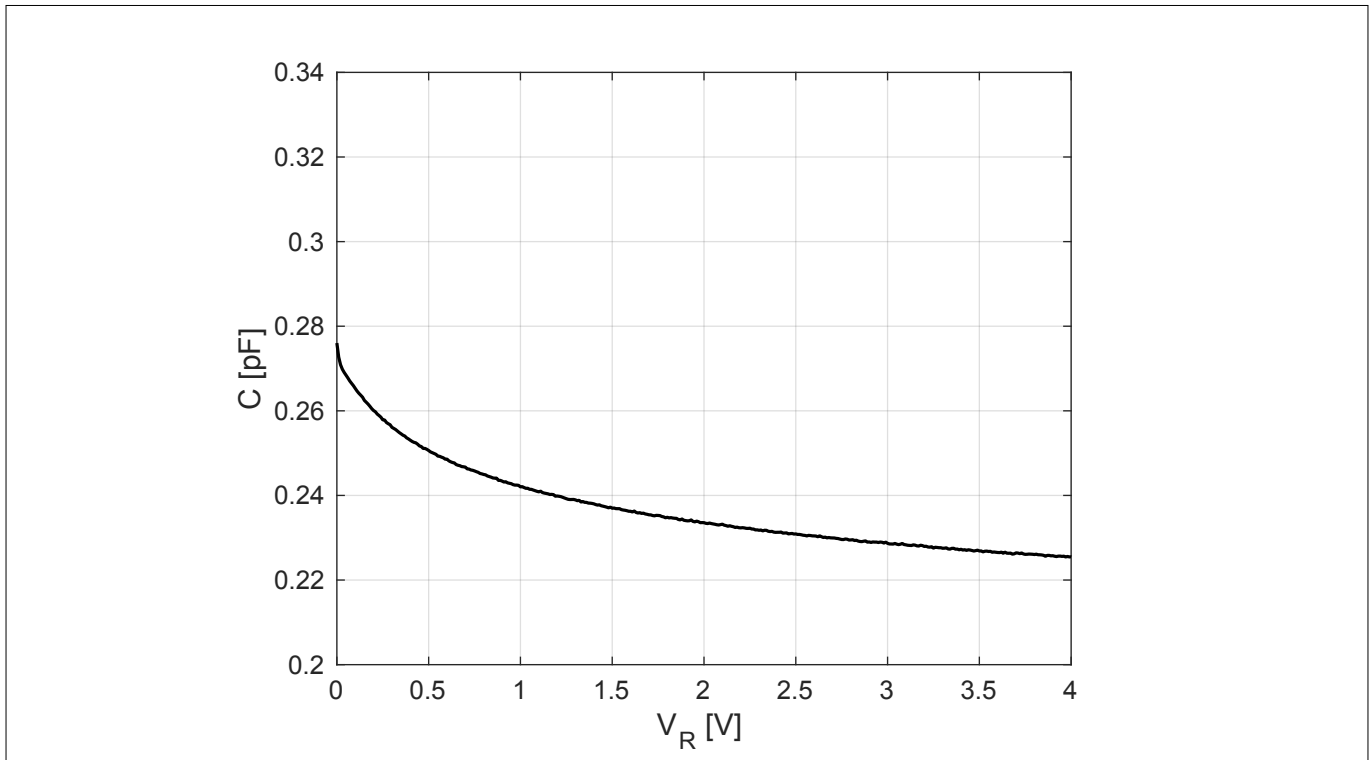

**Figure 1** Diode capacitance  $C$  vs. reverse voltage  $V_R$  at frequency  $f = 1\text{ MHz}$

<sup>1)</sup> 
$$R_F = \frac{V_F(50\text{ mA}) - V_F(10\text{ mA})}{50\text{ mA} - 10\text{ mA}}$$

**Electrical performance in test fixture**

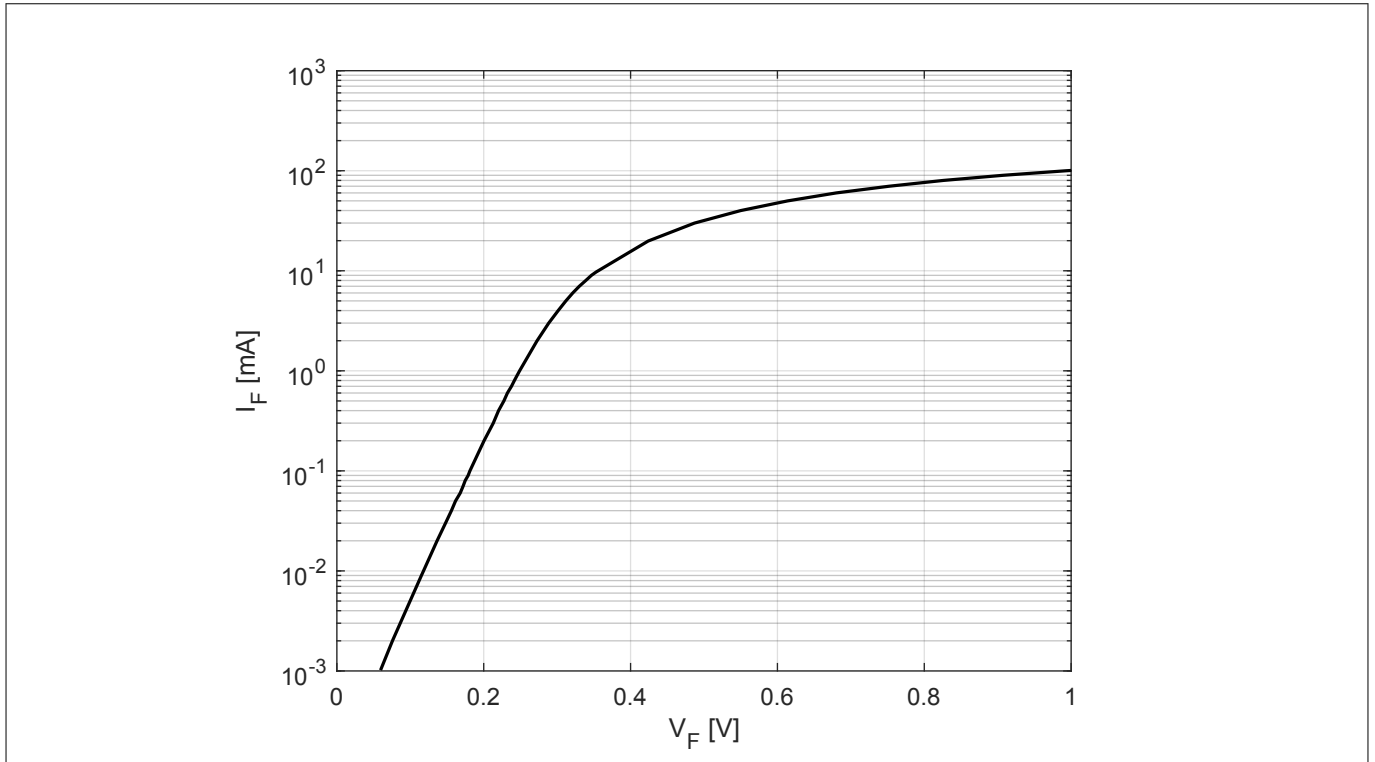

**Figure 2 Forward current  $I_F$  vs. forward voltage  $V_F$**

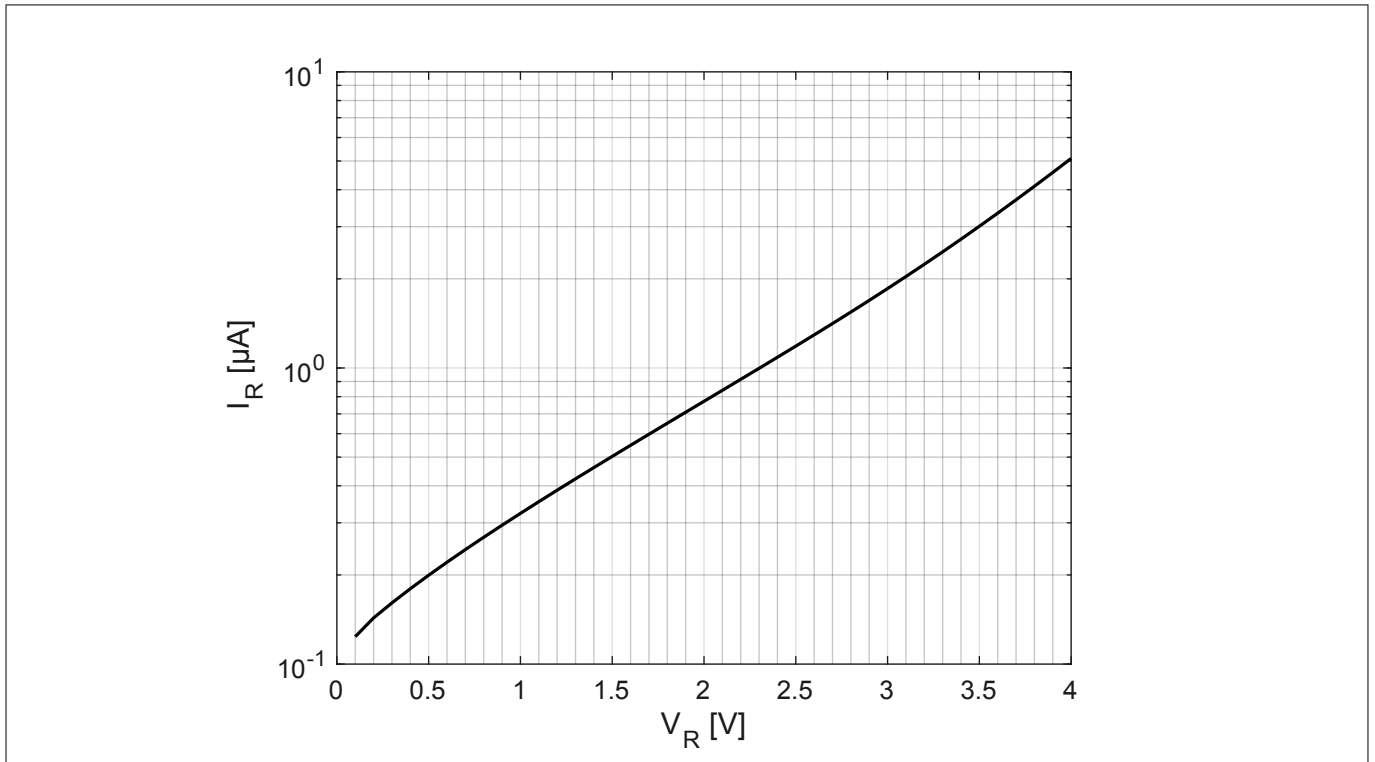

**Figure 3 Reverse current  $I_R$  vs. reverse voltage  $V_R$**

*Note: The curves shown in this chapter have been generated using typical devices but shall not be understood as a guarantee that all devices have identical characteristic curves.*

**Thermal characteristics**

**3 Thermal characteristics**

**Table 4 Thermal resistance**

Parameter	Symbol	Values			Unit	Note or test condition
		Min.	Typ.	Max.		
Thermal resistance (junction - soldering point)	$R_{thJS}$	-	715	-	K/W	$T_S = 78\text{ °C}$ <sup>1)</sup>

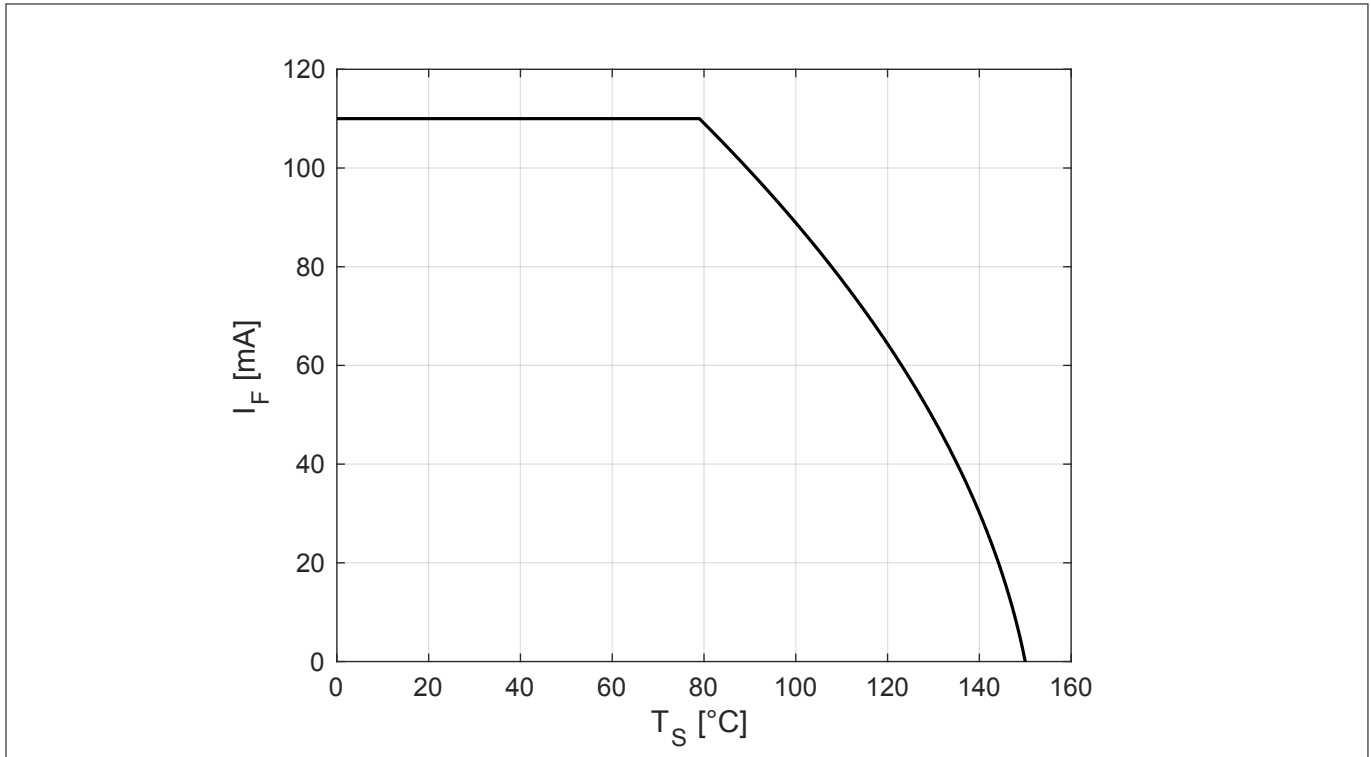

**Figure 4 Permissible forward current  $I_F$  in DC operation**

<sup>1</sup> For  $R_{thJS}$  in other conditions refer to the curves in this chapter.

**Thermal characteristics**

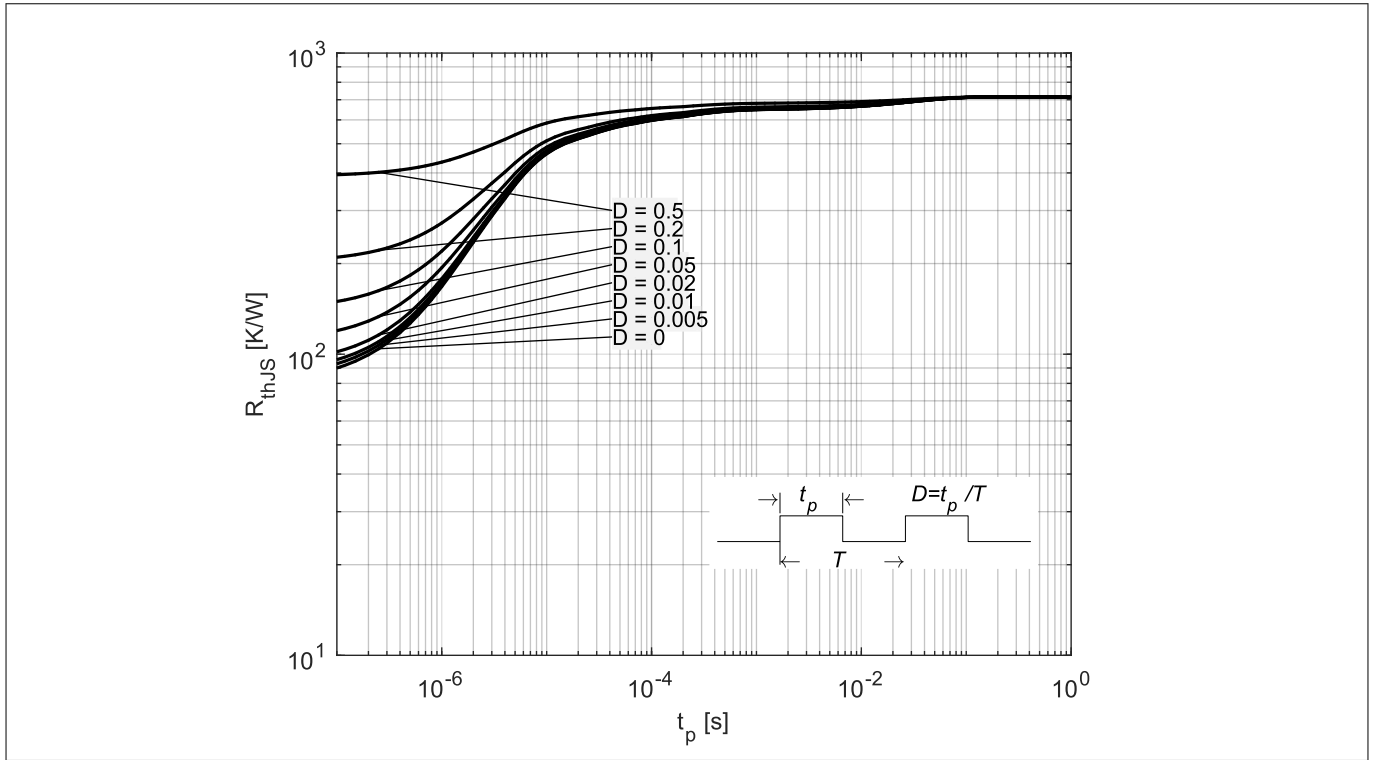

**Figure 5 Thermal resistance  $R_{thJS}$  in pulse operation**

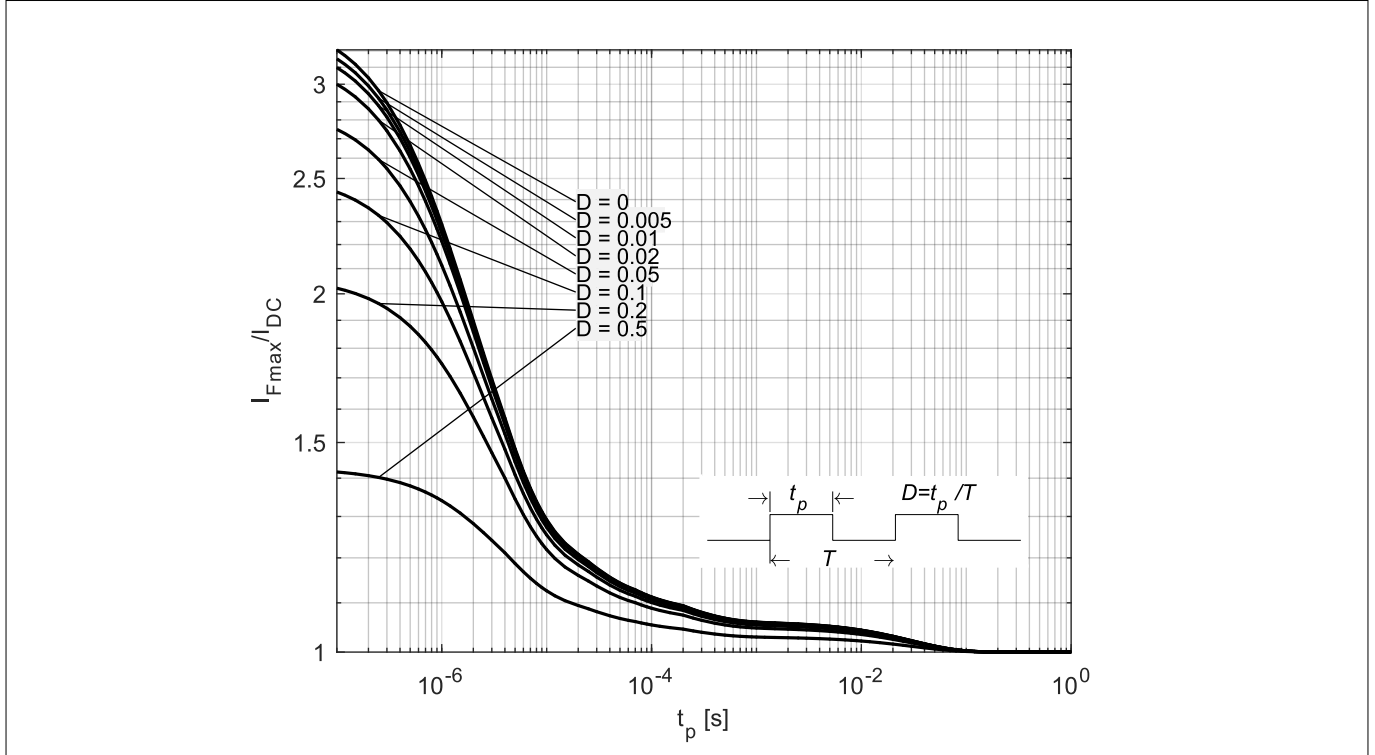

**Figure 6 Permissible forward current ratio  $I_{Fmax} / I_{DC}$  in pulse operation**

**Package information SOD323**

**4 Package information SOD323**

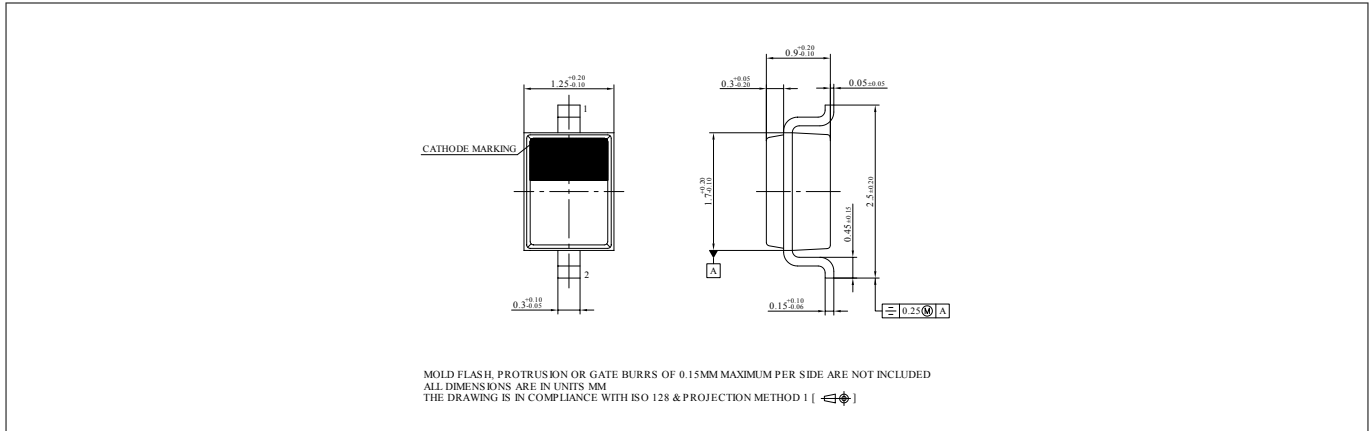

**Figure 7 Package outline**

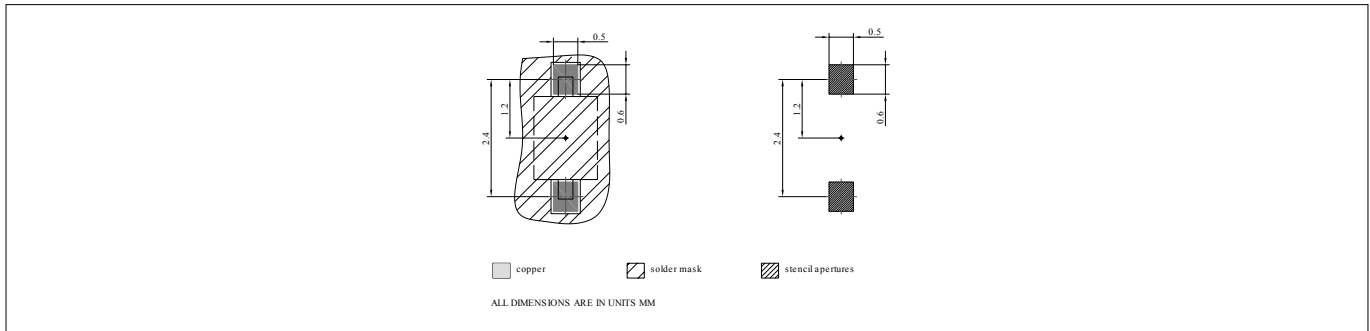

**Figure 8 Foot print**

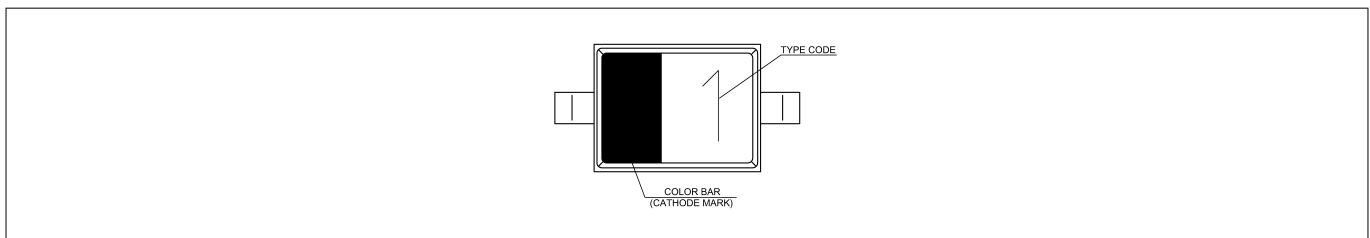

**Figure 9 Marking layout example**

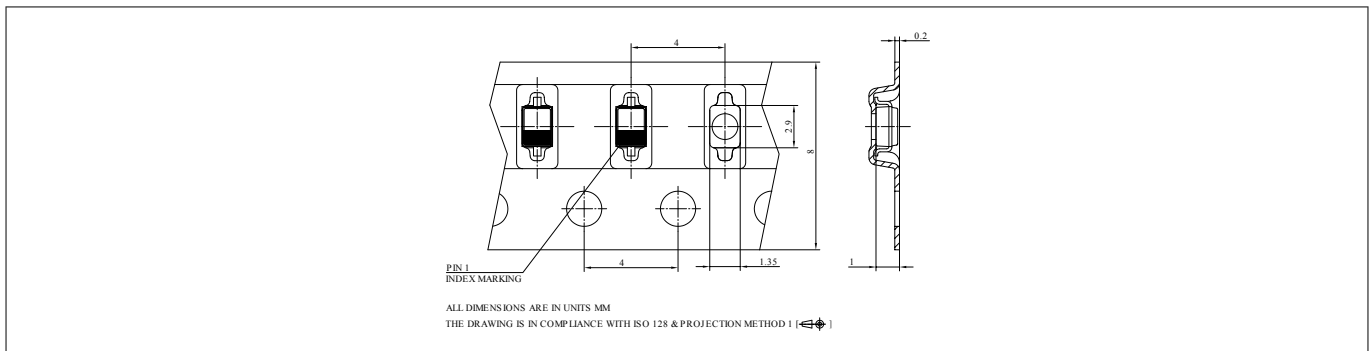

**Figure 10 Tape dimensions**

---

Revision history

## Revision history

Document version	Date of release	Description of changes
1.0	2018-09-07	<ul style="list-style-type: none"><li>• Change from series datasheet to individual one</li><li>• Initial release of datasheet</li><li>• Typical values and curves updated to the values of the production (No product or process change behind)</li><li>• Typical values added</li><li>• Typical curves removed</li></ul>



## Trademarks

All referenced product or service names and trademarks are the property of their respective owners.

**Edition 2018-06-30**

**Published by**

**Infineon Technologies AG**

**81726 Munich, Germany**

**© 2018 Infineon Technologies AG**

**All Rights Reserved.**

**Do you have a question about any aspect of this document?**

**Email: [erratum@infineon.com](mailto:erratum@infineon.com)**

**Document reference**

**IFX-fcx1515055878528**

## IMPORTANT NOTICE

The information given in this document shall in no event be regarded as a guarantee of conditions or characteristics ("Beschaffheitsgarantie").

With respect to any examples, hints or any typical values stated herein and/or any information regarding the application of the product, Infineon Technologies hereby disclaims any and all warranties and liabilities of any kind, including without limitation warranties of non-infringement of intellectual property rights of any third party.

In addition, any information given in this document is subject to customer's compliance with its obligations stated in this document and any applicable legal requirements, norms and standards concerning customer's products and any use of the product of Infineon Technologies in customer's applications.

The data contained in this document is exclusively intended for technically trained staff. It is the responsibility of customer's technical departments to evaluate the suitability of the product for the intended application and the completeness of the product information given in this document with respect to such application.

## WARNINGS

Due to technical requirements products may contain dangerous substances. For information on the types in question please contact your nearest Infineon Technologies office.

Except as otherwise explicitly approved by Infineon Technologies in a written document signed by authorized representatives of Infineon Technologies, Infineon Technologies' products may not be used in any applications where a failure of the product or any consequences of the use thereof can reasonably be expected to result in personal injury