

THIS IS A C.A.D. GENERATED DRAWING
DO NOT MAKE MANUAL REVISIONS TO MASTER.

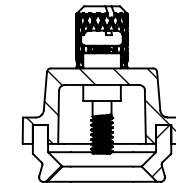

ISSUE NUMBER

ORIGINAL ①

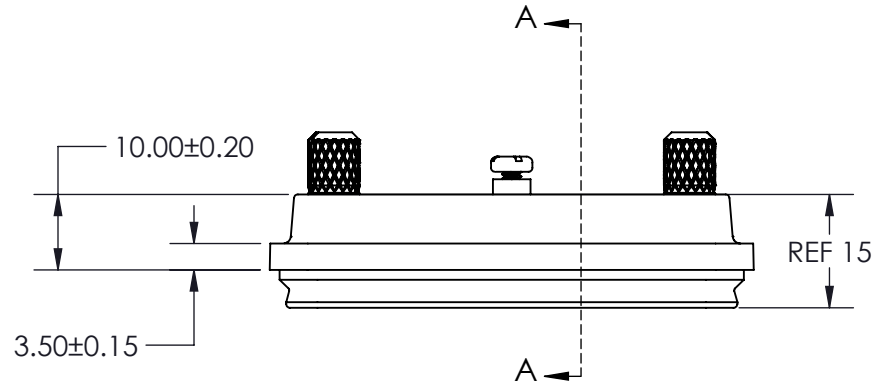
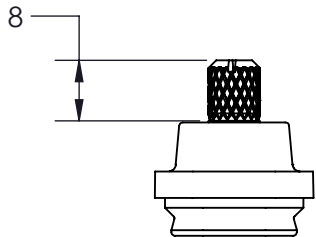
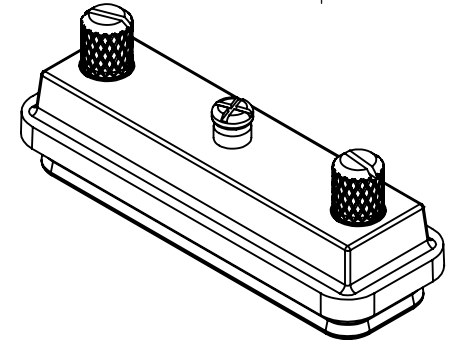
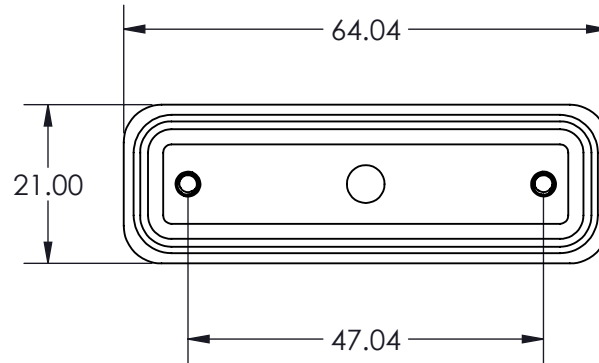

SECTION A-A
SCALE 1 : 1



THIS SERIES FULLY CONFORMS TO THE EUROPEAN UNION DIRECTIVES 2002/95/EC AND 2002/96/EC FOR RoHS COMPLIANCY.

Materials and Finish

1. Body: ABS, UL94V-0, Black
2. Gasket: Silicon, Black
3. O-Ring: Silicon, Black
4. Thumb-Screw: #4-40 UNC, Nickel Plated
5. Screw: M3 X 0.6, Nickel Plated
6. Chain: SUS

DEGREE OF PROTECTION: IP67 AS PER IEC60529

Standard Density Waterproof D-Sub Connector
COVER
627-229-025-010



EDAC INC
TORONTO, ONTARIO
CANADA

YOUR CONNECTION TO QUALITY & SERVICE

THESE DRAWINGS AND SPECIFICATIONS ARE THE PROPERTY OF EDAC INC. AND SHALL NOT BE REPRODUCED, OR COPIED OR USED AS THE BASIS FOR THE MANUFACTURE OR SALE OF APPARATUS WITHOUT WRITTEN PERMISSION.

ACAD REFERENCE NO. 627-229-025-010	
DRAWN: R.STA.MONICA	DATE: June.4/13
CHECKED:	DATE:
SCALE: NTS	SHEET 1 OF 1
DRAWING NUMBER 627-229-025-010	ISSUE 1