

Non-Contact Safety Switches

FFS Series

004747

Issue 5

Datasheet



DESCRIPTION

Honeywell FFS Series switches are coded magnetically actuated non-contact safety limit switches for use in machine guarding applications. The FFS Series of switches are designed to monitor the position of a guard for a safety-related system. For ease of operation, a green LED is integral to the switch and turns on when the switch senses the actuator. The rectangular design of the switch and actuator can be beneficial where a slim package size is desired. A magnetic actuator is supplied with each switch. The switch and actuator are each installed with two M4 or #8 mounting hardware. The non-contact switch design allows for flexible installations where misalignment of the machine guard may occur. The switch and actuator are sealed to IP67 for wet and dusty environmental applications.

With CE and UL certifications, these switches can be installed on machinery for global applications.

VALUE TO CUSTOMERS

- Non-contact minimizes installation and set-up
- Pre-wired cable with color-coded individual lead-wire or integral Micro AC ½ in - 20 quick disconnect connector simplifies electrical connection
- Actuator can approach switch from head-on, slide-by, or rotation/hinge for flexible installation

FEATURES

- Non-contact design requires no operating force to actuate switch
- ABS plastic housing for switch and actuator
- Green LED on switch for guard status indication
- Slim package size: 19,0 mm x 19,0 mm x 82,5 mm [0.75 in x 0.75 in x 3.25 in]
- Choice of 1 NC/1 NO or 2 NC contacts
- Pre-wired cable length of 3 meters or 10 meters or an integral Micro AC ½ in - 20 quick disconnect
- IP67 environmentally sealed switch and actuator
- CE and UL 508 Certifications

DIFFERENTIATION

- Non-contact requires no mechanical linkage to actuate the FFS Series switch
- Integral green LED provides status of NC switch contacts
- Up to two safety contacts when actuated for inputs to safety circuit
- Optional auxiliary contact closes when actuator moves out of the operating range

POTENTIAL APPLICATIONS

Equipment and machinery guards

- Can forming and filling (aluminum, plastic, and steel)
- Packaging equipment
- Pick and place assembly equipment
- Plastic molding equipment
- Printing machinery
- Semiconductor equipment
- Textile machinery
- Woodworking equipment

PORTFOLIO

Honeywell offers a wide range of FF Series magnetically actuated non-contact switches as well as other non-interlocking safety switches which include the GSS Series electromechanical limit switches and the cable/rope pull switches (1CPS Series single head and 2CPS Series dual head). Honeywell safety interlocking switches include the metal housing EN50041 GK Series, metal housing solenoid (trapped key) GKL/R Series, miniature plastic housing GKM Series, EN50047 plastic housing GKE Series, and plastic housing GKN Series.

To view the product portfolio, click [here](#).

Non-Contact Safety Switch, FFS Series

Table 1. Specifications

Characteristic	Parameter
Description	Coded magnetically actuated non-contact safety switch, FFS Series
Certifications	UL (UL508) File E37138 cUL (C22.2 No.14) File 37138 CE DOC A346 Reference standards: EN 60947-5-1; Low voltage switchgear and controlgear EN 60947-5-3; Low voltage switchgear and controlgear EN 61000-6-2; Electro magnetic compatibility for immunity EN 61000-6-4; Electro magnetic compatibility for emissions EN 60204-1; Safety of machinery, Electrical equipment of machines EN 62061; Safety of machinery, Functional safety EN ISO 13849-1; Safety of machinery, Safety-related parts of control systems
Switch and actuator housing material	ABS plastic
Termination	Pre-wired 6 conductor color-coded cable Ø 7,3 mm [0.29 in] 3 meters or 6 meters length Micro AC ½ in - 20 quick disconnect, 6 pin male with dual keyway
Supply voltage sensor circuit	24 Vdc
Contacts (when actuator present)	1NC/1NO, 2NC
Contact design	Magnetically actuated
Safety contact rating	120/230 Vac, 2 A 24 Vdc, 2 A
Auxiliary contact rating	120/230 Vac, 2 A 24 Vdc, 2 A
LED indicator	Green LED "ON" when actuator present
External fuse (customer supplied)	1.6 A fast acting
Environmental sealing	IP67 for switch and actuator
Operating temperature	-25 °C to 55 °C [-13 °F to 131 °F]
Vibration/shock	50 Hz to 100 Hz/10 g

Figure 1. FFS Series Distance

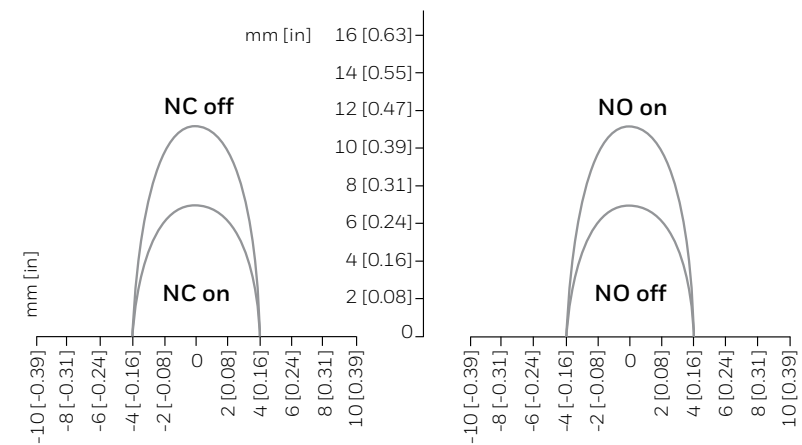

Normally closed circuit is the safety contact/switch and is closed when the actuator is sensed by the the switch.

Normally open circuit is an optional auxiliary contact which closes when the actuator is no longer sensed.

Non-Contact Safety Switch, FFS Series

Figure 2. FFS Series Contacts

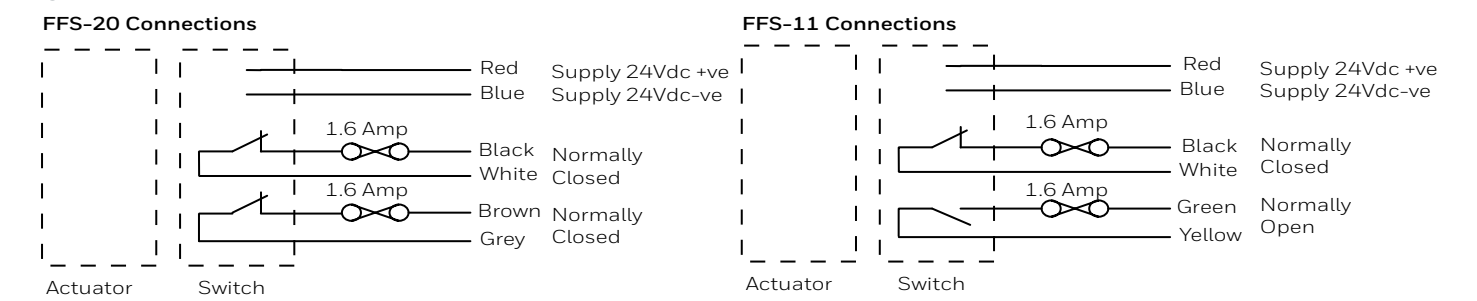

NOTE: Contact configurations show under closed condition for guard device.

Figure 3. FFS Series Connections

FFS SERIES PRE-WIRED CONNECTION

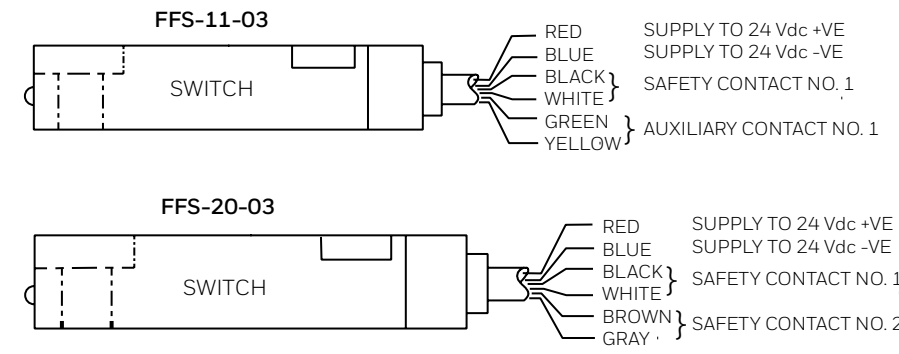

FFS SERIES QD CONNECTION

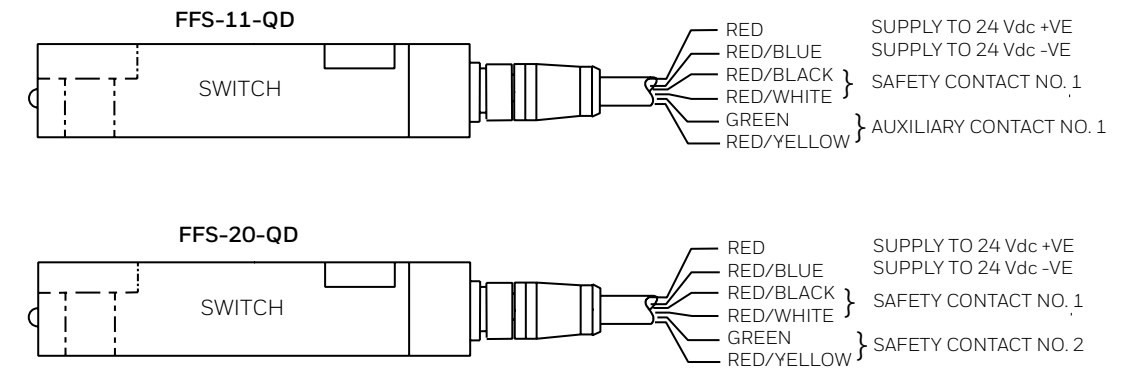

Non-Contact Safety Switch, FFS Series

Figure 4. FFS Series Quick Disconnect Pinout

Connector Description Cable

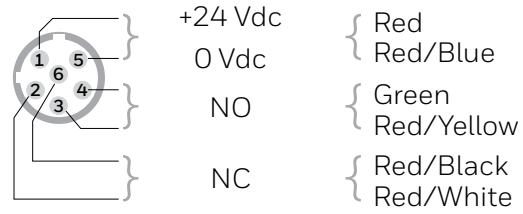

Connector
Micro AC ½ in – 20
6 Pole, Dual Key Way

Connector Description Cable

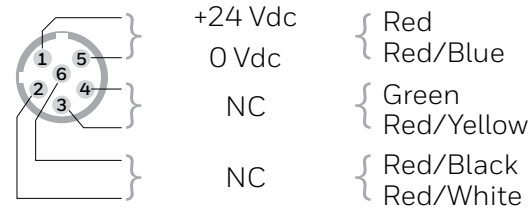

Connector
Micro AC ½ in – 20 in
6 Pole, Dual Key Way

Table 2. FFS Series Order Guide: ABS Plastic Housing

Catalog Listing	Description
FFS-11-03	Switch and actuator, 1NC safety and 1NO auxiliary contacts, 3 meters pre-wired cable
FFS-11-10	Switch and actuator, 1NC safety and 1NO auxiliary contacts, 10 meters pre-wired cable
FFS-11-QD	Switch and actuator, 1NC safety and 1NO auxiliary contacts, Micro AC ½ in – 20 quick disconnect integral connector
FFS-11-QD05	Switch and actuator, 1NC safety and 1NO auxiliary contacts, Micro AC ½ in – 20 quick disconnect integral connector, 5 meters cable with integral 4 pin female connector
FFS-20-03	Switch and actuator, 2NC safety contacts, 3 meters pre-wired cable
FFS-20-10	Switch and actuator, 2NC safety contacts, 10 meters pre-wired cable
FFS-20-QD	Switch and actuator, 2NC safety contacts, Micro AC ½ in – 20 quick disconnect integral connector
FFS-ACT	Replacement actuator for FFS Series switches

Non-Contact Safety Switch, FFS Series

Figure 5. FFS Series Dimensions

FFS SERIES PRE-WIRED mm[in]

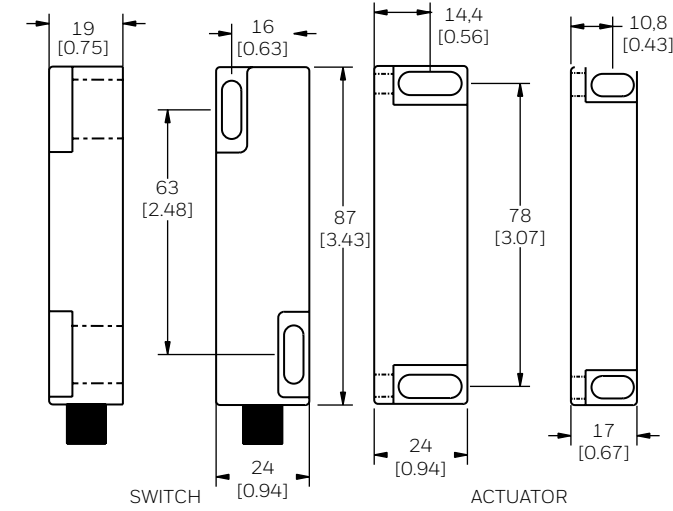

FFS SERIES QC mm[in]

(with MI2 Brad Harrison Connector)

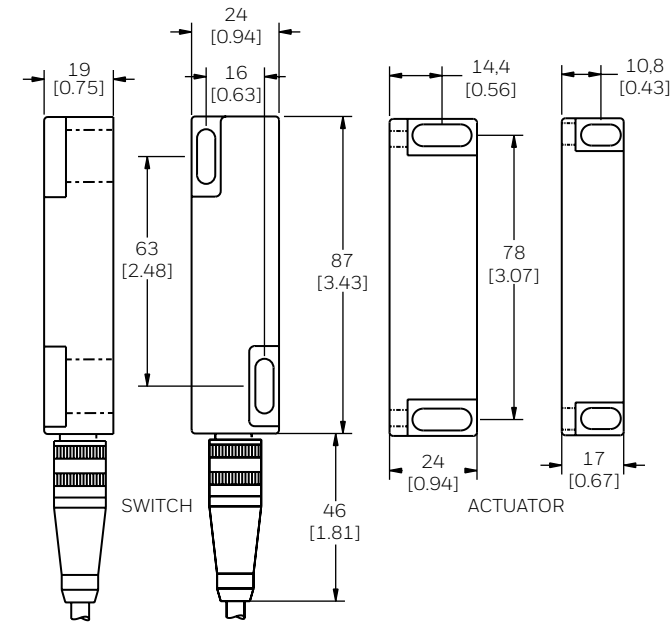

Note: Switches will accept 4 mm or #8 mounting hardware.

ADDITIONAL MATERIALS

The following associated literature is available on the Honeywell website at sps.honeywell.com/ast:

- Product installation guide
- Product range guide

For more information

Honeywell Advanced Technologies services its customers through a worldwide network of sales offices and distributors. For application assistance, current specifications, pricing or the nearest Authorized Distributor, visit sps.honeywell.com/ast or call:

Asia Pacific	+65 6355-2828
Europe	+44 1698 481481
USA/Canada	+1-800-537-6945

Honeywell Advanced Technologies

830 East Arapaho Road
Richardson, TX 75081
sps.honeywell.com/ast

⚠ WARNING **RISK TO LIFE OR PROPERTY**

Never use this product for an application involving serious risk to life or property without ensuring that the system as a whole has been designed to address the risks, and that this product is properly rated and installed for the intended use within the overall system.

Failure to comply with these instructions could result in death or serious injury.

⚠ WARNING **MISUSE OF DOCUMENTATION**

- The information presented in this product sheet is for reference only. Do not use this document as a product installation guide.
- Complete installation, operation, and maintenance information is provided in the instructions supplied with each product.

Failure to comply with these instructions could result in death or serious injury.

Warranty/Remedy

Honeywell warrants goods of its manufacture as being free of defective materials and faulty workmanship during the applicable warranty period. Honeywell's standard product warranty applies unless agreed to otherwise by Honeywell in writing; please refer to your order acknowledgment or consult your local sales office for specific warranty details. If warranted goods are returned to Honeywell during the period of coverage, Honeywell will repair or replace, at its option, without charge those items that Honeywell, in its sole discretion, finds defective. **The foregoing is buyer's sole remedy and is in lieu of all other warranties, expressed or implied, including those of merchantability and fitness for a particular purpose. In no event shall Honeywell be liable for consequential, special, or indirect damages.**

While Honeywell may provide application assistance personally, through our literature and the Honeywell web site, it is buyer's sole responsibility to determine the suitability of the product in the application.

Specifications may change without notice. The information we supply is believed to be accurate and reliable as of this writing. However, Honeywell assumes no responsibility for its use.