

## 2-Input / 1-Output Stereo Audio Selector

### ■ GENERAL DESCRIPTION

The **NJM2752** is 2-Input / 1-Output Stereo Audio Selector.

The **NJM2752** consists of switches and buffer operational amplifiers.

Based on the internal switch op-amp technology, the **NJM2752** features lower output noise, lower distortion and higher channel separation than the general Multiplexers or Analogue Switches.

The **NJM2752** contains compatibility with the NJM2753 (3in-1out SW), NJM2755 (4in-1out SW). It is suitable for LCD-TV/PDP-TV, Car Stereo, and Any Audio System.

### ■ PACKAGE OUTLINE



**NJM2752RB2**  
**(MSOP10 (TVSP10))**



**NJM2752V**  
**(SSOP14)**

### ■ FEATURES

- Operating Voltage 4.7 to 10V
  - 2-Input / 1-Output Stereo Audio Selectors
  - Low Output Noise -114dBV typ.
  - Low Distortion 0.0009% typ.
  - Bipolar Technology
  - Package Outline MSOP10 (TVSP10)\*  
SSOP14
- \*MEET JEDEC MO-187-DA / THIN TYPE

### ■ BLOCK DIAGRAM

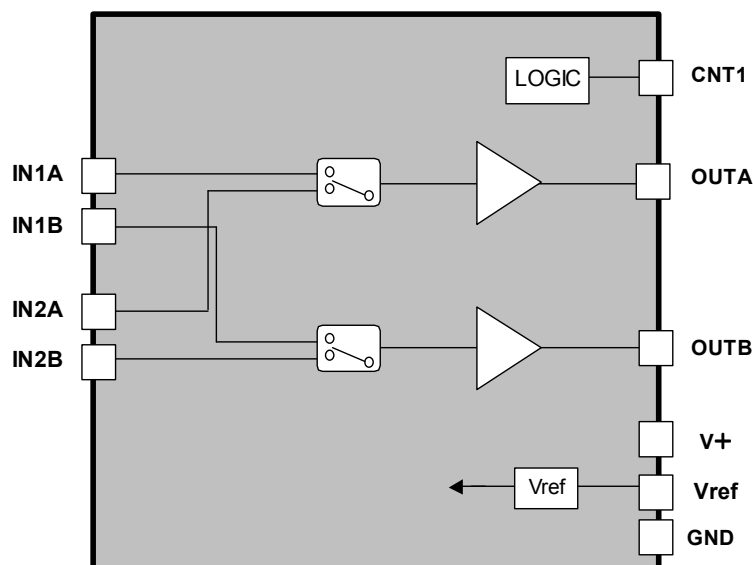

# NJM2752

## ■ PIN CONFIGURATIONS

MSOP10 (TVSP10),SSOP14

### MSOP10 (TVSP10)

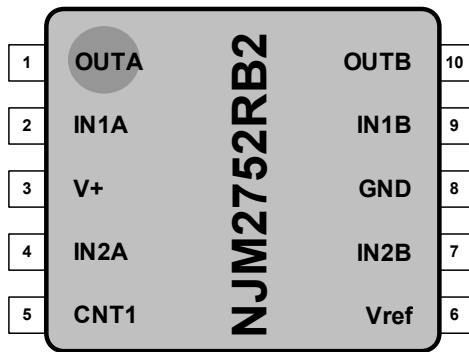

### SSOP14

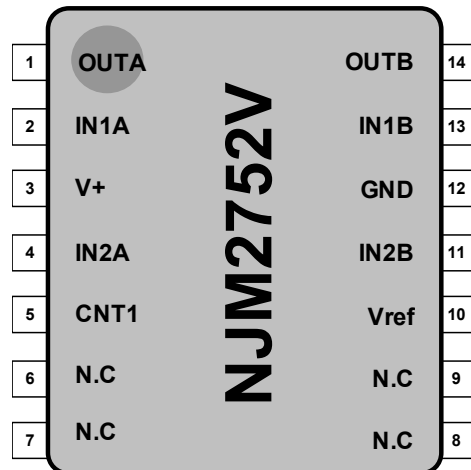

PIN.No. (MSOP10 (TVSP10))	PIN.No. (SSOP14)	SYMBOL	FUNCTION	PIN.No. (MSOP10 (TVSP10))	PIN.No. (SSOP14)	SYMBOL	FUNCTION
1	1	OUTA	Ach Output Terminal	6	10	Vref	Reference Terminal
2	2	IN1A	Ach Input Terminal1	7	11	IN2B	Bch Input Terminal2
3	3	V+	Power Supply Terminal	8	12	GND	GND Terminal
4	4	IN2A	Ach Input Terminal2	9	13	IN1B	Bch Input Terminal1
5	5	CNT1	Control Switch Terminal1	10	14	OUTB	Bch Output Terminal
	6,7 8,9	N.C	No Connection				

### [Reference]

The NJM2752 contains compatibility with the NJM2753 (3in-1out SW), NJM2755 (4in-1out SW).

### NJM2753

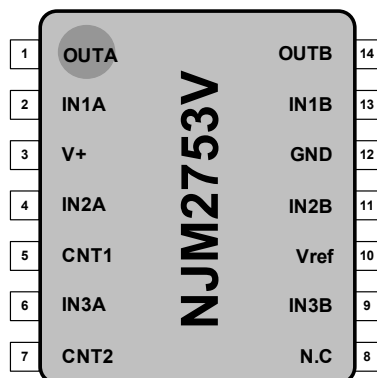

### NJM2755

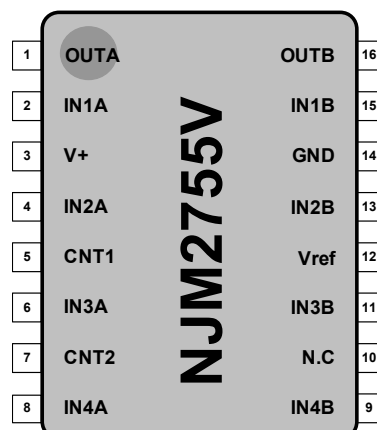

## ■ ABSOLUTE MAXIMUM RATINGS (Ta=25°C)

PARAMETER	SYMBOL	RATING	UNIT
Supply Voltage	V <sup>+</sup>	12	V
Power Dissipation	P <sub>D</sub>	MSOP10 (TVSP10): 470 <sup>1)</sup> , 640 <sup>2)</sup> SSOP14: 450 <sup>1)</sup> , 570 <sup>2)</sup> NOTE 1): EIA/JEDEC STANDARD Test board (76.2x114.3x1.6mm, 2layer, FR-4) mounting NOTE 2): EIA/JEDEC STANDARD Test board (76.2x114.3x1.6mm, 4layer, FR-4) mounting	mW
Operating Temperature Range	T <sub>OPR</sub>	-40 to +85	°C
Storage Temperature Range	T <sub>STR</sub>	-40 to +150	°C

## ■ ELECTRICAL CHARACTERISTICS ( Ta=25°C, V<sup>+</sup>=9V)

PARAMETER	SYMBOL	TEST CONDITION	MIN.	TYP.	MAX.	UNIT
Operating Voltage	V <sup>+</sup>		4.7	9.0	10	V
Supply Current	I <sub>CC</sub>	No Signal	-	10	15	mA
Reference Voltage	V <sub>REF</sub>		-	4.5	-	V
Voltage Gain	G <sub>V</sub>	V <sub>in</sub> =1V <sub>rms</sub> , f=1kHz	-1	0	1	dB
Total Harmonic Distortion	THD+N	V <sub>in</sub> =1V <sub>rms</sub> , f=1kHz	-	0.0009	0.03	%
Output Noise Voltage	V <sub>NO</sub>	A-Weighted	-	-114 (2)	-100 (10)	dBV (μV <sub>rms</sub> )
Maximum Output Voltage	V <sub>OM</sub>	f=1kHz, THD=1%	6 (2.0)	8 (2.5)	-	dBV (V <sub>rms</sub> )
Cross Talk	CT	V <sub>in</sub> =1V <sub>rms</sub> , f=1kHz, A-Weighted	70	100	-	dB
Channel Separation	CS	V <sub>in</sub> =1V <sub>rms</sub> , f=1kHz, A-Weighted	80	110	-	dB
Switch-ON Voltage Level	V <sub>CH</sub>		2.4	-	-	V
Switch-OFF Voltage Level	V <sub>CL</sub>		-	-	0.5	V
Input Impedance	R <sub>IN</sub>		-	100	-	kΩ
Output Impedance	R <sub>OUT</sub>		-	45	-	Ω

## ■ SWITCH CONTROL LOGIC

CNT1	INPUT SELECTOR Ach / Bch
L	1
H	2

# NJM2752

## ■ MEASUREMENT CIRCUIT (SSOP14)

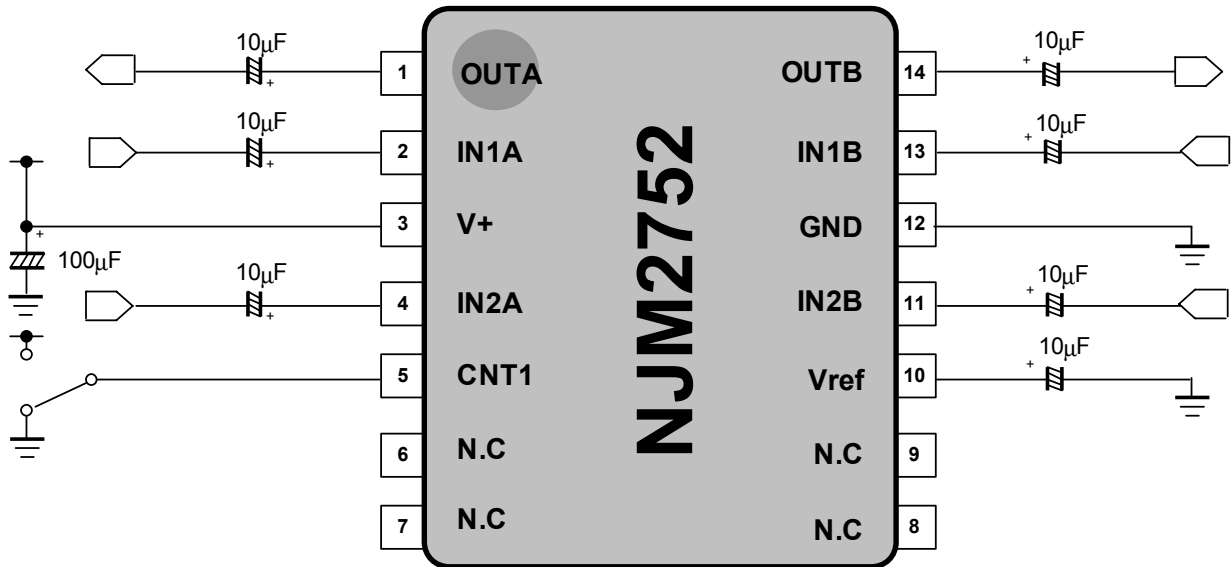

## ■ APPLICATION CIRCUIT (SSOP14)

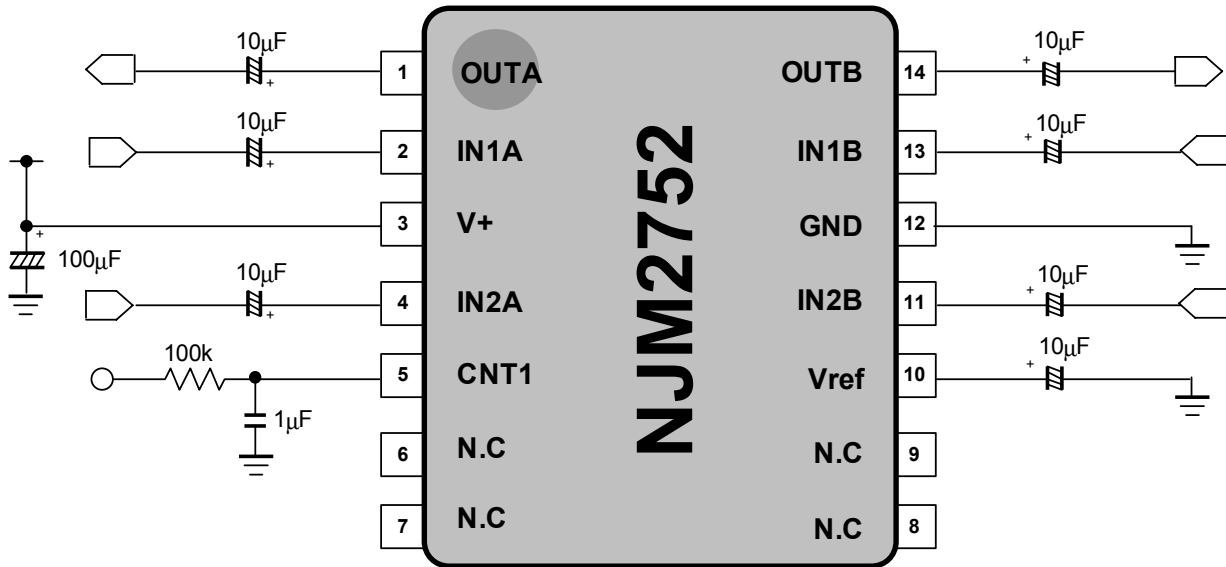

### Application note:

Resistor(100k) and capacitor(1µF) connected to CNT1 are added to reduce pop-noise.

The value of input capacitor connected to IN1A and IN2A depends on cut-off frequency(calculated by  $f_c=1/2\pi RC$ ) you need. R(input impedance)=100kΩ.

# NJM2752

## ■ TERMINAL DESCRIPTION

PIN No.	SYMBOL	FUNCTION	EQUIVALENT CIRCUIT	TERMINAL VOLTAGE
2 4 11 13	IN1A IN2A IN1B IN2B	Ach Input Terminal1 Ach Input Terminal2 Bch Input Terminal2 Bch Input Terminal1		V+/2
5	CNT1	Control Switch Terminal1		0V (GND)
1 14	OUTA OUTB	Ach Output Terminal Bch Output Terminal		V+/2
10	Vref	Reference Terminal		V+/2
3 12	V+ GND	Power Supply Terminal GND Terminal		V+ 0V

## ■ TYPICAL CHARACTERISTICS

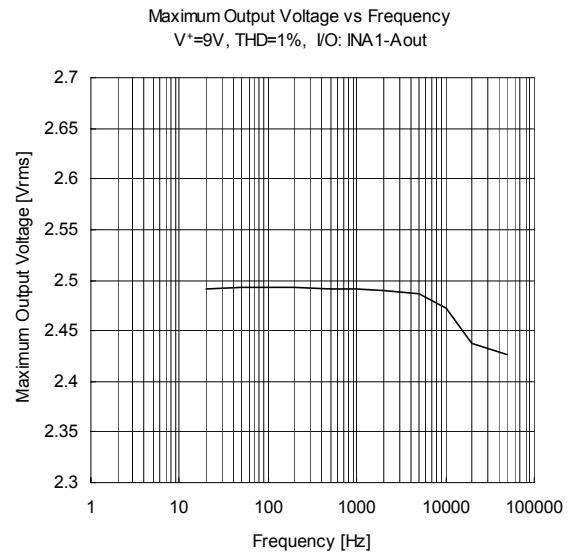
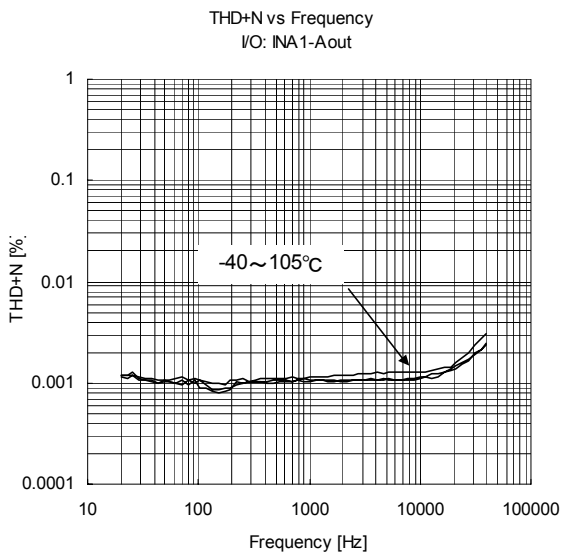
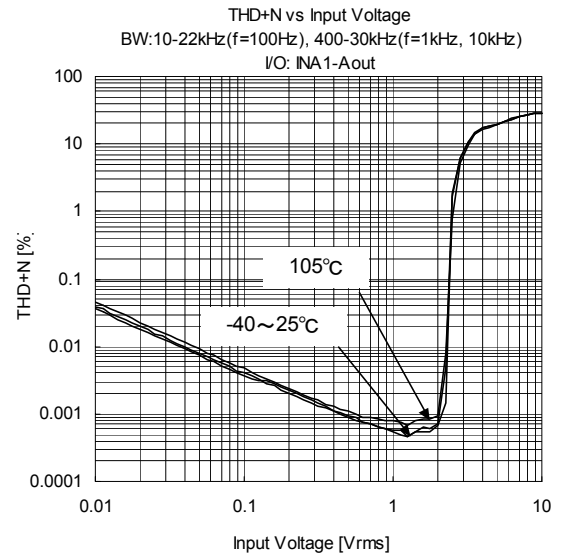
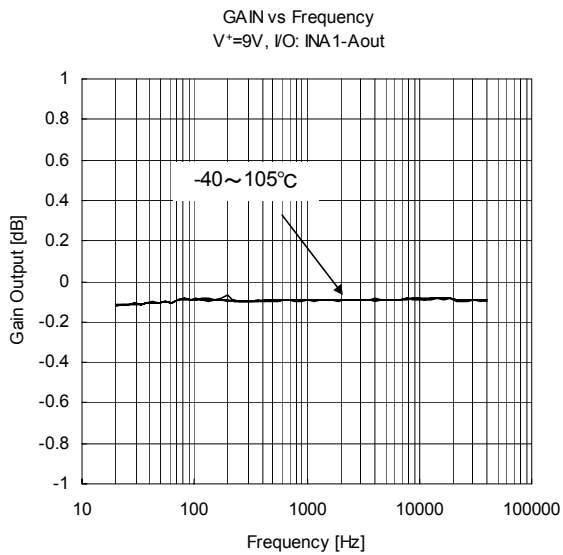
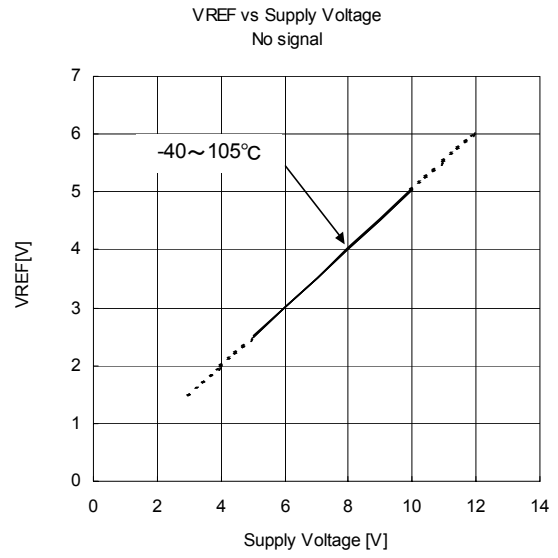
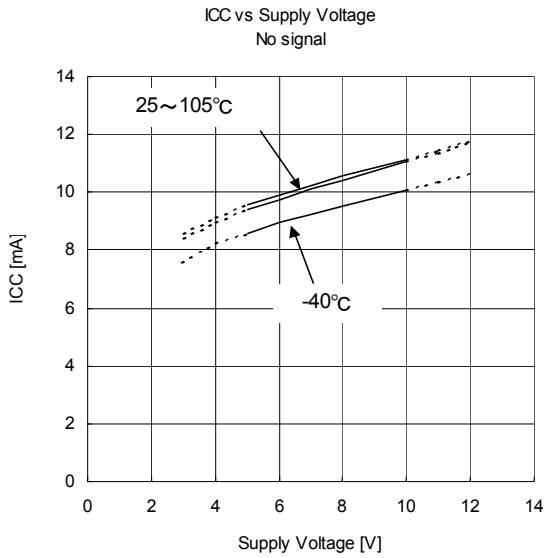

## ■ TYPICAL CHARACTERISTICS

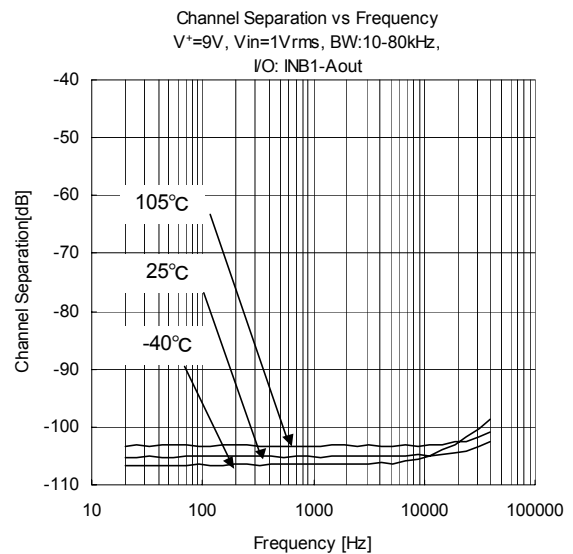
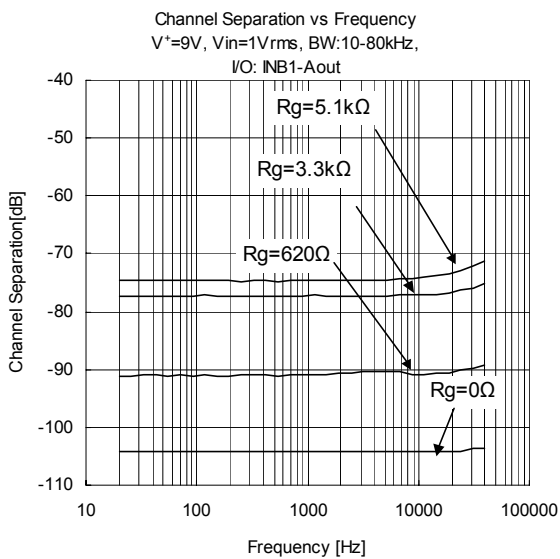
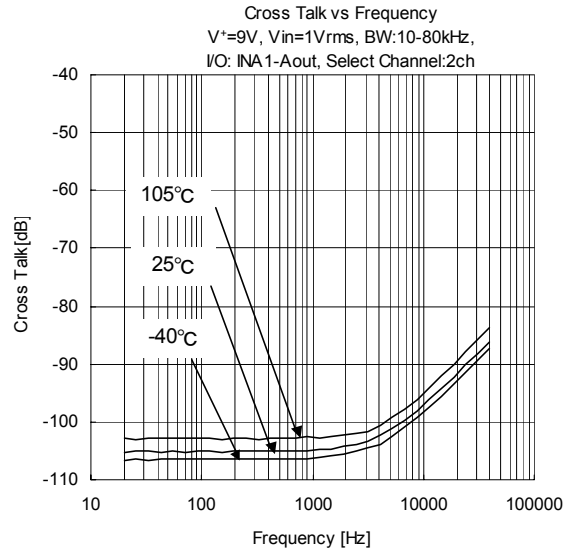
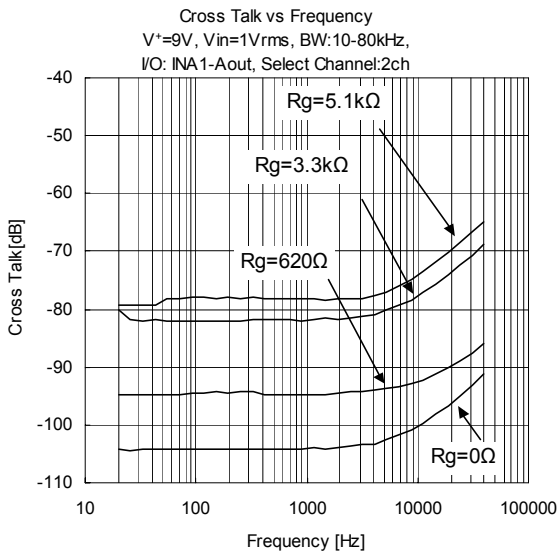
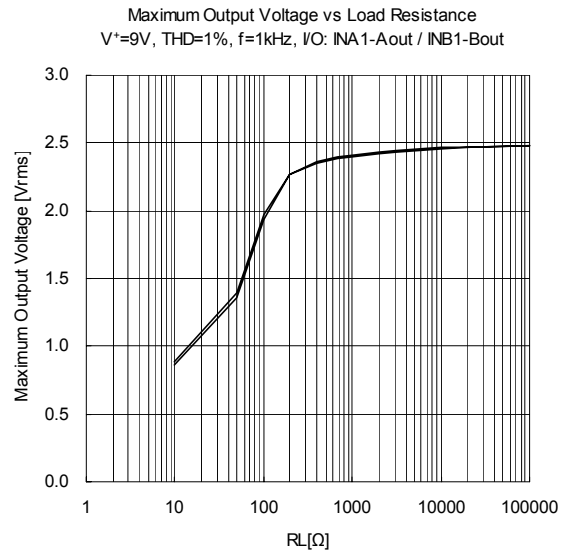
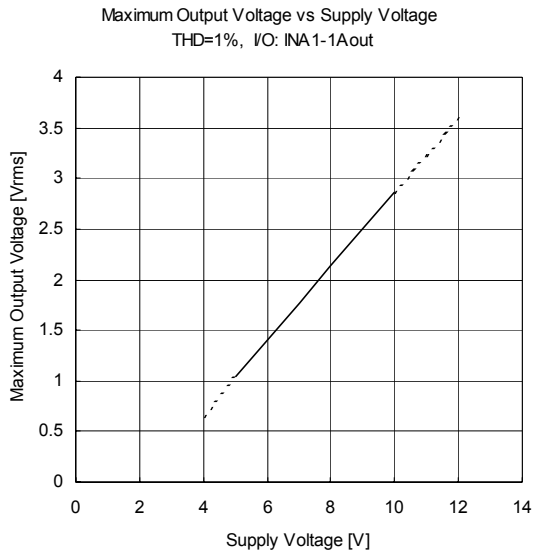



## ■ TYPICAL CHARACTERISTICS

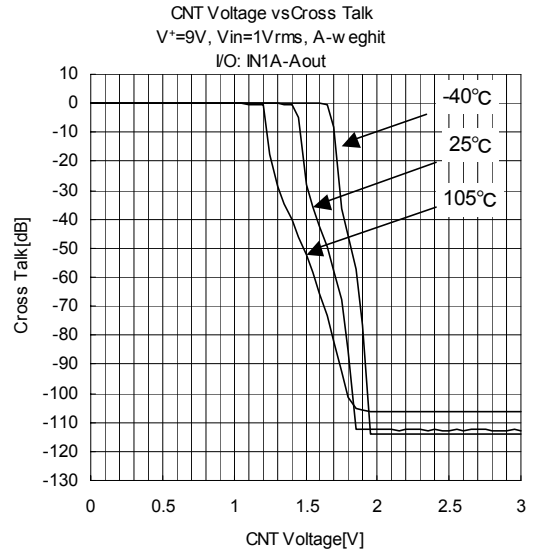
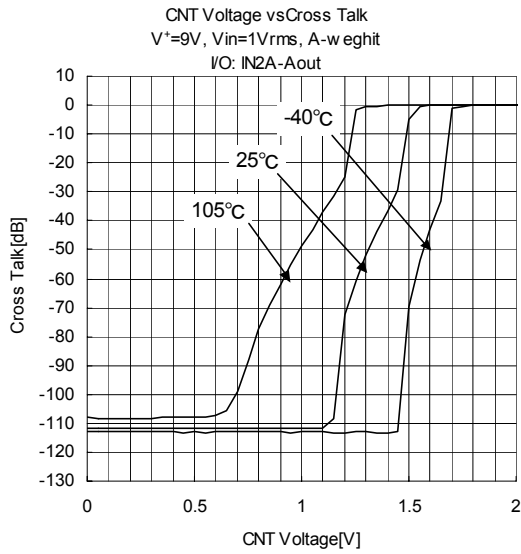

**[CAUTION]**

The specifications on this databook are only given for information, without any guarantee as regards either mistakes or omissions. The application circuits in this databook are described only to show representative usages of the product and not intended for the guarantee or permission of any right including the industrial rights.