



Parameter	Rating	Units
Breakdown Voltage - $BV_{CEO}$	30	$V_P$
Current Transfer Ratio - CTR (typical)	8500	%
Saturation Voltage - $V_{CE(sat)}$	1	V
Input Control Current - $I_F$	1	mA

### Features

- 100mA Continuous Load Rating
- 3750V<sub>rms</sub> Input/Output Isolation
- Unidirectional Input
- Small 6-Pin Package, Thru-Hole or Surface Mount
- Machine Insertable, Wave Solderable
- Surface Mount Tape & Reel Packaging Available

### Applications

- Telecom Switching
- Tip/Ring Circuits
- Modem Switching (Laptop, Notebook, Pocket Size)
- Loop Detect
- Ringing Detect
- Current Sensing

### Description

LDA111 is a unidirectional-input optocoupler with a Darlington-transistor output. The LDA111 has a minimum current transfer ratio (CTR) of 300% with a maximum value of 30,000%.

### Approvals

- UL Recognized Component: File E76270
- CSA Certified Component: Certificate 1175739
- EN/IEC 60950-1 Certified Component:  
TUV Certificate B 09 07 49410 006

### Ordering Information

Part Number	Description
LDA111	6-Pin DIP (50/tube)
LDA111S	6-Pin Surface Mount (50/tube)
LDA111STR	6-Pin Surface Mount (1000/Reel)

### Pin Configuration

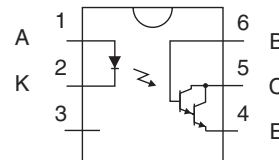

### Absolute Maximum Ratings @ 25°C

Parameter	Ratings	Units
Breakdown Voltage	30	V <sub>P</sub>
Reverse Input Voltage	5	V
Input Control Current	100	mA
Peak (10ms)	1	A
Power Dissipation		
Input Power Dissipation <sup>1</sup>	150	mW
Phototransistor <sup>2</sup>	150	
Isolation Voltage, Input to Output	3750	V <sub>rms</sub>
Operational Temperature	-40 to +85	°C
Storage Temperature	-40 to +125	°C

<sup>1</sup> Derate linearly 1.33mW / °C

<sup>2</sup> Derate linearly 2mW / °C

Absolute Maximum Ratings are stress ratings. Stresses in excess of these ratings can cause permanent damage to the device. Functional operation of the device at conditions beyond those indicated in the operational sections of this data sheet is not implied.

### Electrical Characteristics @ 25°C

Parameter	Conditions	Symbol	Min	Typ	Max	Units
<b>Output Characteristics</b>						
Phototransistor Breakdown Voltage	I <sub>C</sub> = 100µA	BV <sub>CEO</sub>	30	85	-	V
Phototransistor Dark Current	V <sub>CEO</sub> = 5V, I <sub>F</sub> = 0mA	I <sub>CEO</sub>	-	50	500	nA
Saturation Voltage	I <sub>C</sub> = 3mA, I <sub>F</sub> = 1mA	V <sub>CE(sat)</sub>	-	-	1	V
Current Transfer Ratio	I <sub>F</sub> = 1mA, V <sub>CE</sub> = 2V	CTR	300	8500	30000	%
Output Capacitance	25V, f = 1MHz	C <sub>OUT</sub>	-	3	-	pF
<b>Input Characteristics</b>						
Input Control Current	I <sub>C</sub> = 3mA, V <sub>CE</sub> = 2V	I <sub>F</sub>	-	0.07	1	mA
Input Voltage Drop	I <sub>F</sub> = 5mA	V <sub>F</sub>	0.9	1.2	1.4	V
Reverse Input Current	V <sub>R</sub> = 5V	I <sub>R</sub>	-	-	10	µA
<b>Common Characteristics</b>						
Capacitance, Input to Output	-	C <sub>I/O</sub>	-	3	-	pF

### Switching Characteristics @ 25°C

Characteristic	Symbol	Test Condition	Typ	Units
Turn-On Time	t <sub>on</sub>	V <sub>CC</sub> =5V, I <sub>F</sub> =1mA, R <sub>L</sub> =500Ω	8	µs
Turn-Off Time	t <sub>off</sub>		345	

Switching Time Test Circuit

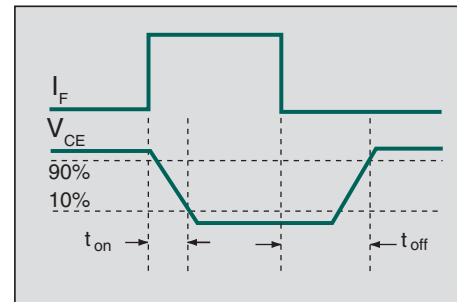
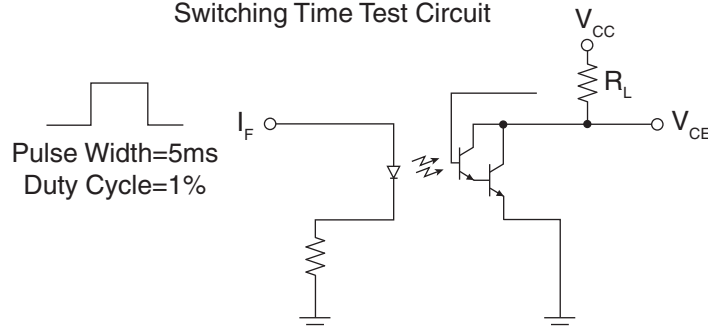

PERFORMANCE DATA @25°C (Unless Otherwise Noted)\*

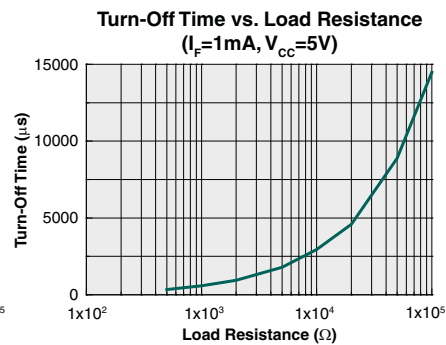
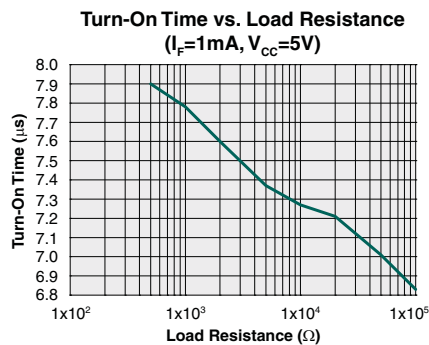
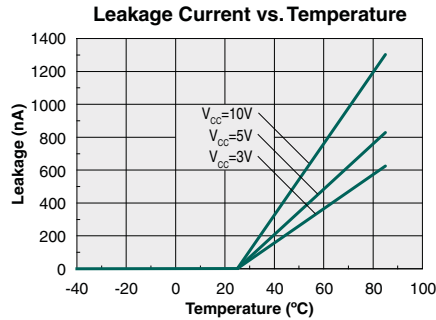
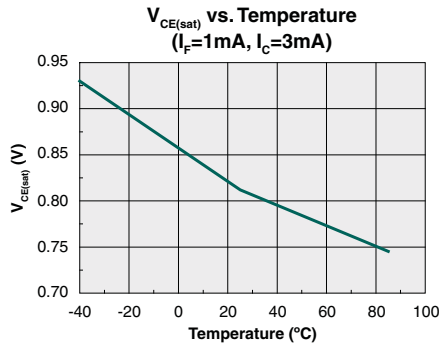
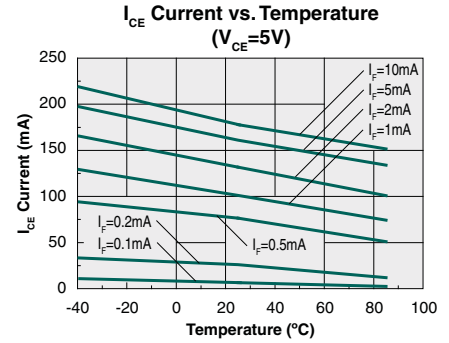
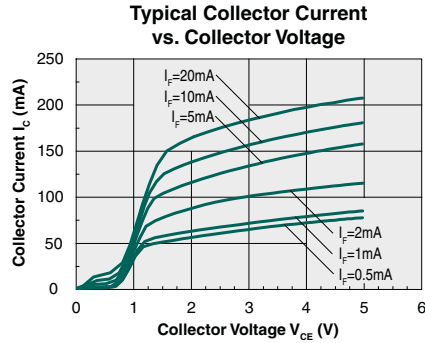
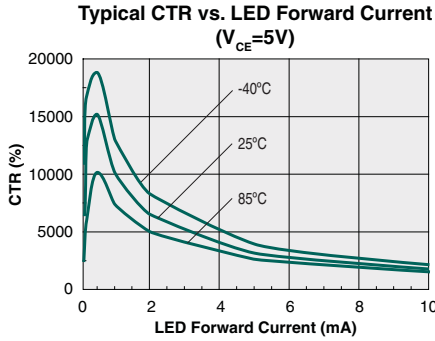
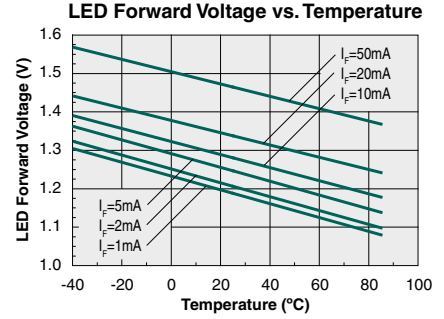
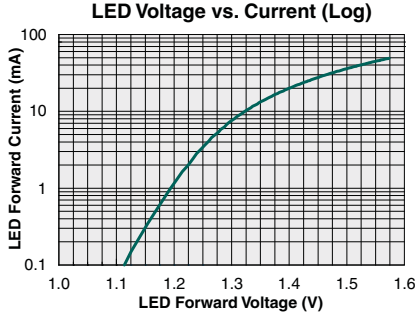
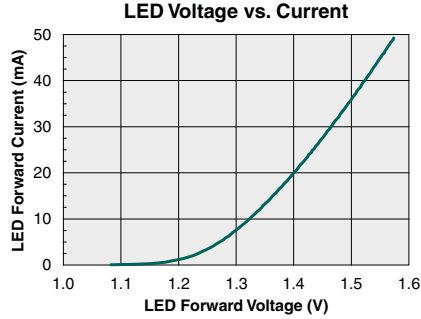

\*The Performance data shown in the graphs above is typical of device performance. For guaranteed parameters not indicated in the written specifications, please contact our application department.

## Manufacturing Information

### Moisture Sensitivity



All plastic encapsulated semiconductor packages are susceptible to moisture ingress. IXYS Integrated Circuits Division classified all of its plastic encapsulated devices for moisture sensitivity according to the latest version of the joint industry standard, **IPC/JEDEC J-STD-020**, in force at the time of product evaluation. We test all of our products to the maximum conditions set forth in the standard, and guarantee proper operation of our devices when handled according to the limitations and information in that standard as well as to any limitations set forth in the information or standards referenced below.

Failure to adhere to the warnings or limitations as established by the listed specifications could result in reduced product performance, reduction of operable life, and/or reduction of overall reliability.

This product carries a **Moisture Sensitivity Level (MSL) rating** as shown below, and should be handled according to the requirements of the latest version of the joint industry standard **IPC/JEDEC J-STD-033**.

Device	Moisture Sensitivity Level (MSL) Rating
LDA111 / LDA111S	MSL 1

### ESD Sensitivity



This product is **ESD Sensitive**, and should be handled according to the industry standard **JESD-625**.

### Reflow Profile

This product has a maximum body temperature and time rating as shown below. All other guidelines of **J-STD-020** must be observed.

Device	Maximum Temperature x Time
LDA111 / LDA111S	250°C for 30 seconds

### Board Wash

IXYS Integrated Circuits Division recommends the use of no-clean flux formulations. However, board washing to remove flux residue is acceptable. Since IXYS Integrated Circuits Division employs the use of silicone coating as an optical waveguide in many of its optically isolated products, the use of a short drying bake could be necessary if a wash is used after solder reflow processes. Chlorine- or Fluorine-based solvents or fluxes should not be used. Cleaning methods that employ ultrasonic energy should not be used.



**Mechanical Dimensions**

**LDA111**

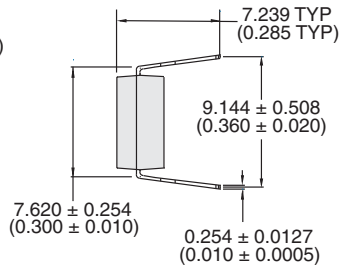
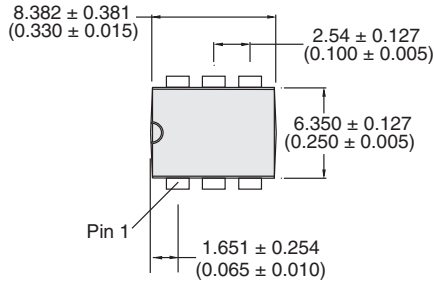

**PCB Hole Pattern**

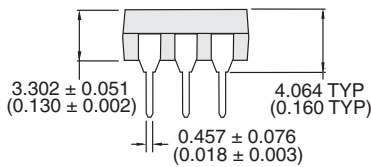
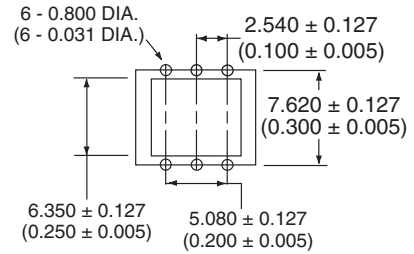

Dimensions  
mm  
(inches)

**LDA111S**

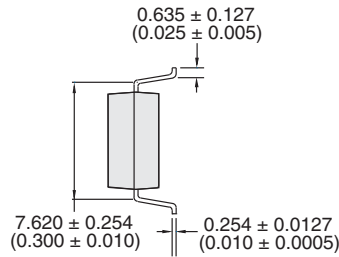
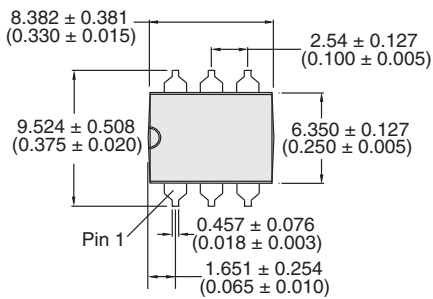

**PCB Land Pattern**

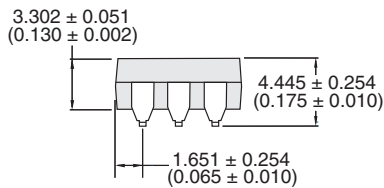
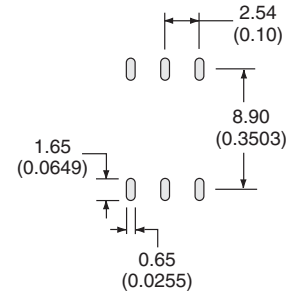

Dimensions  
mm  
(inches)

## LDA111STR Tape & Reel

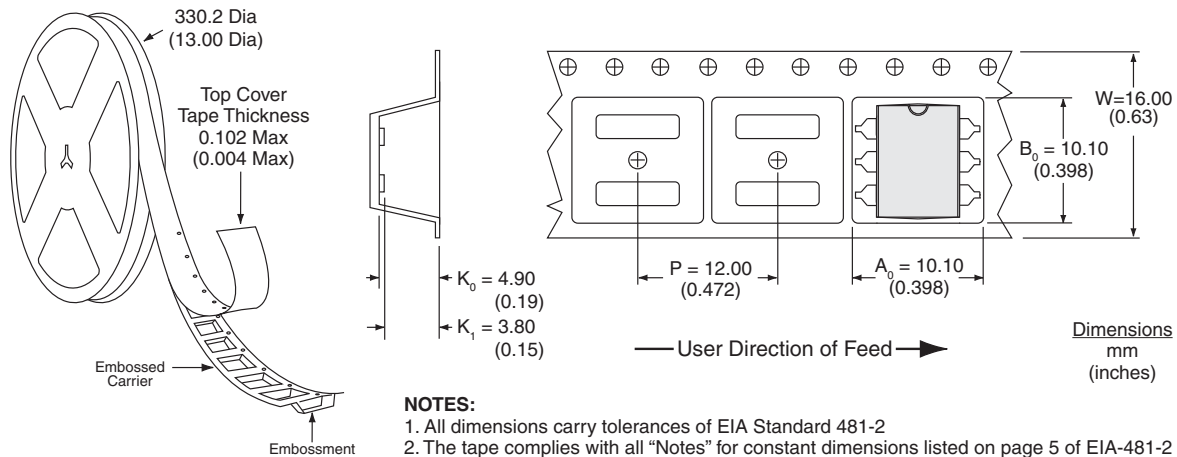

For additional information please visit our website at: [www.ixysic.com](http://www.ixysic.com)

IXYS Integrated Circuits Division makes no representations or warranties with respect to the accuracy or completeness of the contents of this publication and reserves the right to make changes to specifications and product descriptions at any time without notice. Neither circuit patent licenses nor indemnity are expressed or implied. Except as set forth in IXYS Integrated Circuits Division's Standard Terms and Conditions of Sale, IXYS Integrated Circuits Division assumes no liability whatsoever, and disclaims any express or implied warranty, relating to its products including, but not limited to, the implied warranty of merchantability, fitness for a particular purpose, or infringement of any intellectual property right.

The products described in this document are not designed, intended, authorized or warranted for use as components in systems intended for surgical implant into the body, or in other applications intended to support or sustain life, or where malfunction of IXYS Integrated Circuits Division's product may result in direct physical harm, injury, or death to a person or severe property or environmental damage. IXYS Integrated Circuits Division reserves the right to discontinue or make changes to its products at any time without notice.