

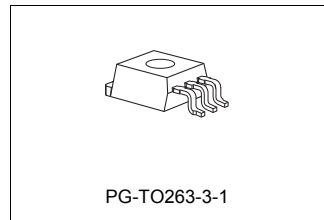

Features

- Output voltage 5 V, 8.5 V or 10 V
- Output voltage tolerance $\leq \pm 4\%$
- Current capability 400 mA
- Low-drop voltage
- Very low current consumption
- Short-circuit proof
- Reverse polarity proof
- Suitable for use in automotive electronics
- Green Product (RoHS compliant) version of TLE 4274
- AEC qualified

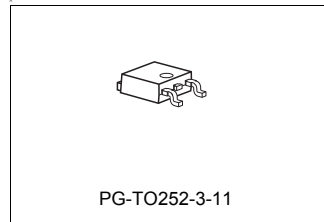
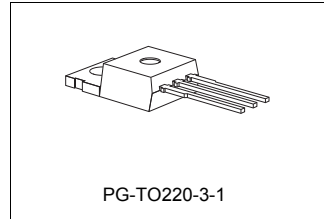

Functional Description

The TLE 4274 is a low drop voltage regulator available in a TO220, TO252 and TO263 package. The IC regulates an input voltage up to 40 V to $V_{Qrated} = 5.0\text{ V (V50)}$, 8.5 V (V85) and 10 V (V10) . The maximum output current is 400 mA. The IC is short-circuit proof and incorporates temperature protection that disables the IC at overtemperature. A 3.3 V and 2.5 V version is also available. For information about the low output voltage types please refer to the data sheet TLE 4274 / 3.3 V; 2.5 V.

Type	Package
TLE 4274 V10	PG-TO220-3-1 (RoHS compliant)
TLE 4274 V50	PG-TO220-3-1 (RoHS compliant)
TLE 4274 V85	PG-TO220-3-1 (RoHS compliant)
TLE 4274 DV50	PG-TO252-3-11 (RoHS compliant)
TLE 4274 GV10	PG-TO263-3-1 (RoHS compliant)
TLE 4274 GV50	PG-TO263-3-1 (RoHS compliant)
TLE 4274 GV85	PG-TO263-3-1 (RoHS compliant)

Dimensioning Information on External Components

The input capacitor C_1 is necessary for compensating line influences. Using a resistor of approx. 1Ω in series with C_1 , the oscillating of input inductivity and input capacitance can be damped. The output capacitor C_Q is necessary for the stability of the regulation circuit. Stability is guaranteed at values $C_Q \geq 22 \mu\text{F}$ and an ESR of $\leq 3 \Omega$ within the operating temperature range.

Circuit Description

The control amplifier compares a reference voltage to a voltage that is proportional to the output voltage and drives the base of the series transistor via a buffer. Saturation control as a function of the load current prevents any oversaturation of the power element. The IC also includes a number of internal circuits for protection against:

- Overload
- Overtemperature
- Reverse polarity

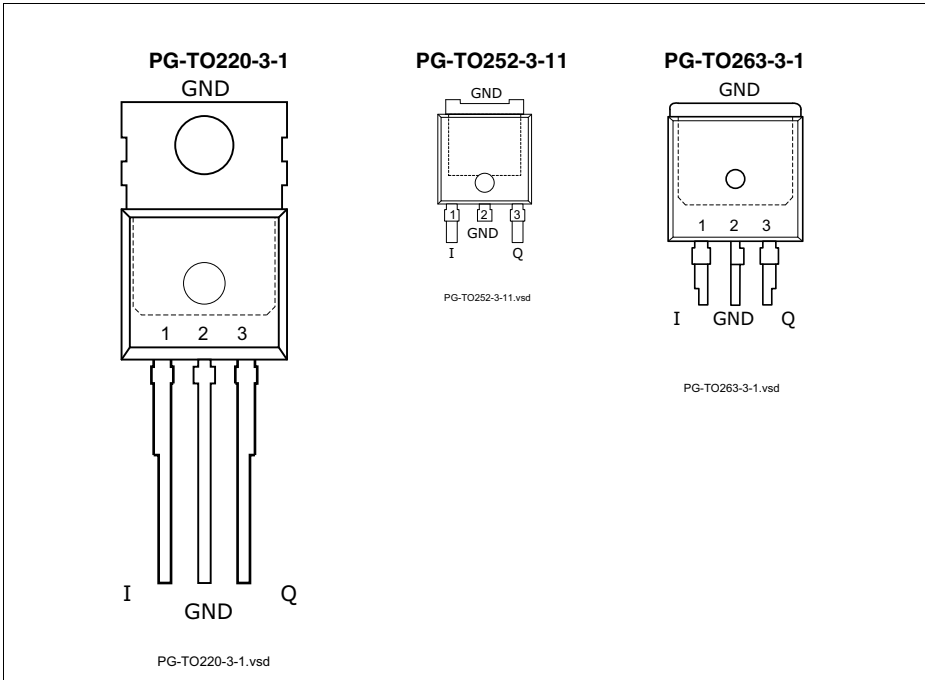

Figure 1 Pin Configuration (top view)

Table 1 Pin Definitions and Functions

Pin No.	Symbol	Function
1	I	Input ; block to ground directly at the IC with a ceramic capacitor.
2	GND	Ground
3	Q	Output ; block to ground with a $\geq 22 \mu\text{F}$ capacitor, $\text{ESR} \leq 3 \Omega$.
TAB	-	TAB ; connect to heatsink and GND to improve thermal performance

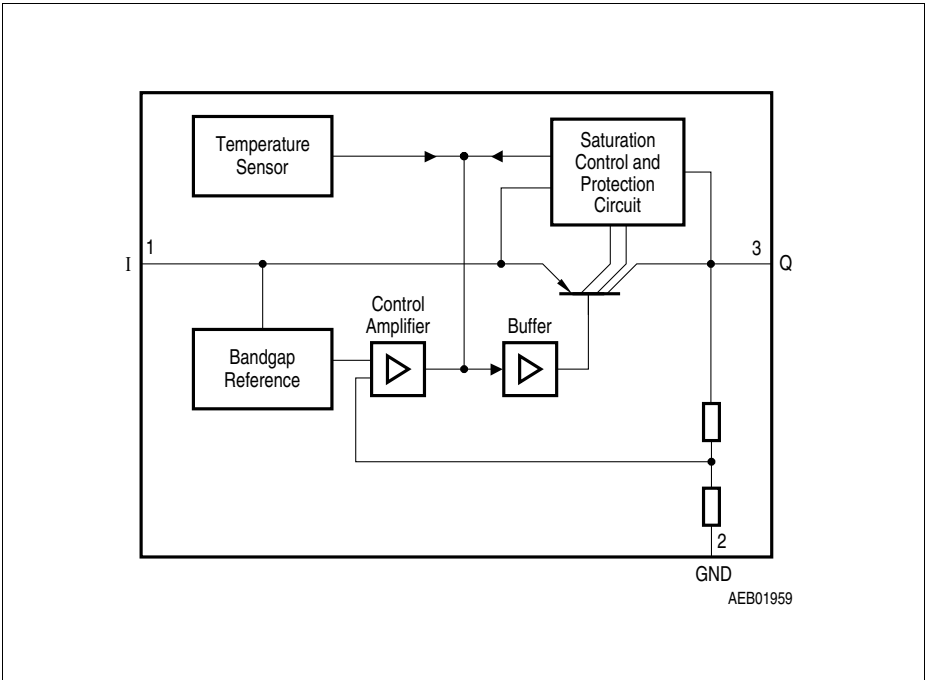

Figure 2 Block Diagram

Table 2 Absolute Maximum Ratings

$T_j = -40$ to 150 °C

Parameter	Symbol	Limit Values		Unit	Test Condition
		Min.	Max.		
Input					
Voltage	V_i	-42	45	V	–
Current	I_i	–	–	–	Internally limited
Output					
Voltage	V_Q	-1.0	40	V	–
Current	I_Q	–	–	–	Internally limited
Ground					
Current	I_{GND}	–	100	mA	–
Temperature					
Junction temperature	T_j	–	150	°C	–
Storage temperature	T_{stg}	-50	150	°C	–

Note: Maximum ratings are absolute ratings; exceeding any one of these values may cause irreversible damage to the integrated circuit.

Table 3 Operating Range

Parameter	Symbol	Limit Values		Unit	Remarks
		Min.	Max.		
Input voltage; V50, DV50, GV50	V_i	5.5	40	V	–
Input voltage, V85, GV85	V_i	9.0	40	V	–
Input voltage, V10, GV10	V_i	10.5	40	V	–
Junction temperature	T_j	-40	150	°C	–

Thermal Resistance

Junction ambient	R_{thja}	–	65	K/W	TO220 ¹⁾
Junction ambient	R_{thja}	–	78	K/W	TO252 ¹⁾
Junction ambient	R_{thja}	–	52	K/W	TO263 ¹⁾
Junction case	R_{thjc}	–	4	K/W	–

1) Worst case; regarding peak temperature, zero airflow mounted on PCB $80 \times 80 \times 1.5$ mm³, 300 mm² heat sink area.

Table 4 Characteristics
 $V_I = 13.5 \text{ V}; -40 \text{ }^\circ\text{C} < T_j < 150 \text{ }^\circ\text{C}$ (unless otherwise specified)

Parameter	Symbol	Limit Values			Unit	Measuring Conditions
		Min.	Typ.	Max.		
Output voltage V50-Version	V_Q	4.8	5	5.2	V	$5 \text{ mA} < I_Q < 400 \text{ mA}$ $6 \text{ V} < V_I < 28 \text{ V}$
Output voltage V50-Version	V_Q	4.8	5	5.2	V	$5 \text{ mA} < I_Q < 200 \text{ mA}$ $6 \text{ V} < V_I < 40 \text{ V}$
Output voltage V85-Version	V_Q	8.16	8.5	8.84	V	$5 \text{ mA} < I_Q < 400 \text{ mA}$ $9.5 \text{ V} < V_I < 28 \text{ V}$
Output voltage V85-Version	V_Q	8.16	8.5	8.84	V	$5 \text{ mA} < I_Q < 200 \text{ mA}$ $9.5 \text{ V} < V_I < 40 \text{ V}$
Output voltage V10-Version	V_Q	9.6	10	10.4	V	$5 \text{ mA} < I_Q < 400 \text{ mA}$ $11 \text{ V} < V_I < 28 \text{ V}$
Output voltage V10-Version	V_Q	9.6	10	10.4	V	$5 \text{ mA} < I_Q < 200 \text{ mA}$ $11 \text{ V} < V_I < 40 \text{ V}$
Output current limitation ¹⁾	I_Q	400	600	–	mA	–
Current consumption; $I_q = I_I - I_Q$	I_q	–	100	220	μA	$I_Q = 1 \text{ mA}$
Current consumption; $I_q = I_I - I_Q$	I_q I_q	–	8	15	mA	$I_Q = 250 \text{ mA}$ $I_Q = 400 \text{ mA}$
		–	20	30	mA	
Drop voltage ¹⁾	V_{dr}	–	250	500	mV	$I_Q = 250 \text{ mA}$ $V_{\text{dr}} = V_I - V_Q$
Load regulation	ΔV_Q	–	20	50	mV	$I_Q = 5 \text{ mA to } 400 \text{ mA}$
Line regulation	ΔV_Q	–	10	25	mV	$\Delta V_I = 12 \text{ V to } 32 \text{ V}$ $I_Q = 5 \text{ mA}$
Power supply ripple rejection	$PSRR$	–	60	–	dB	$f_r = 100 \text{ Hz};$ $V_r = 0.5 \text{ Vpp}$
Temperature output voltage drift	dV_Q/dT	–	0.5	–	mV/K	–

¹⁾ Measured when the output voltage V_Q has dropped 100 mV from the nominal value obtained at $V_I = 13.5 \text{ V}$.

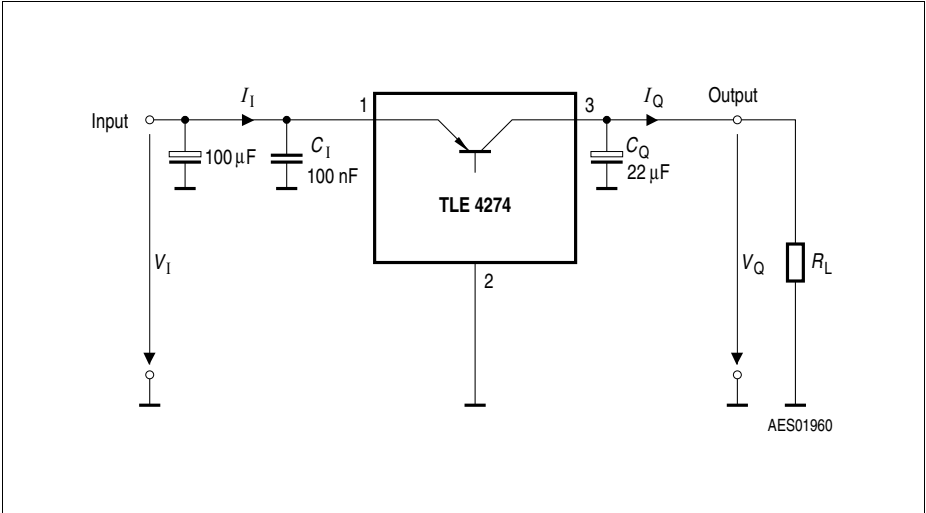

Figure 3 Measuring Circuit

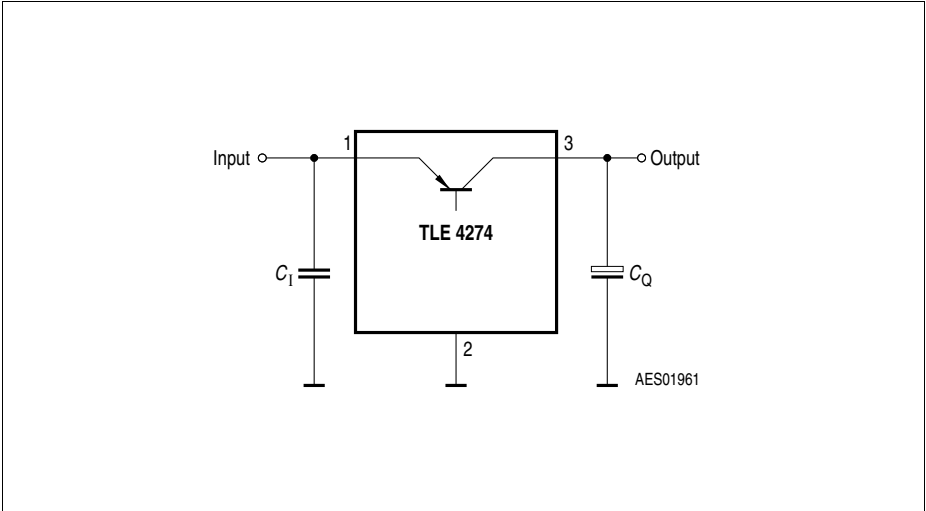
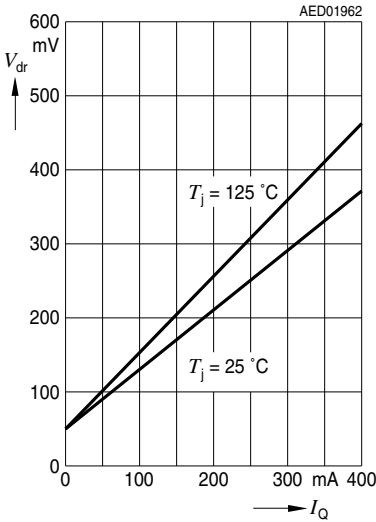

Figure 4 Application Circuit

Typical Performance Characteristics (V50, V85 and V10)

Drop Voltage V_{dr} versus Output Current I_Q



Output Current I_Q versus Input Voltage V_I

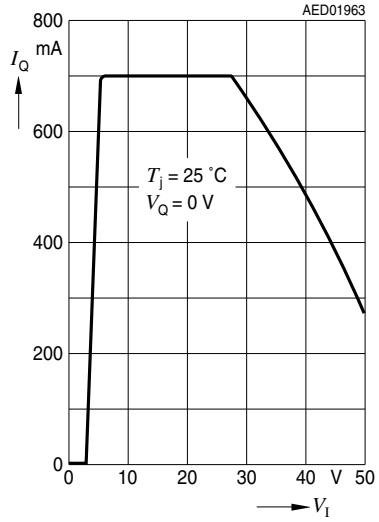

Current Consumption I_q versus Output Current I_Q (high load)

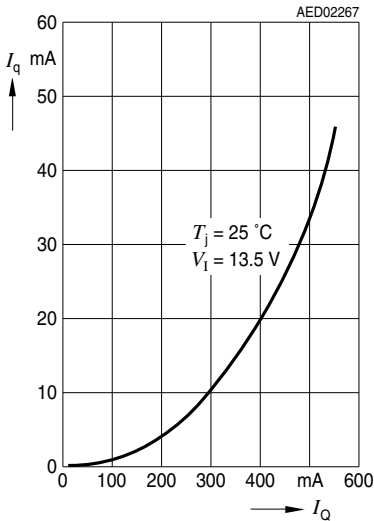

Current Consumption I_q versus Output Current I_Q (low load)

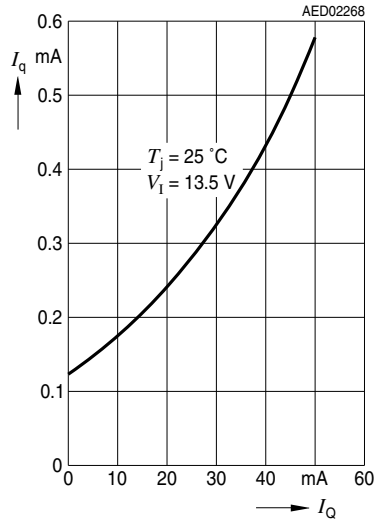

Typical Performance Characteristics (V50)

Output Voltage V_Q versus Junction Temperature T_j

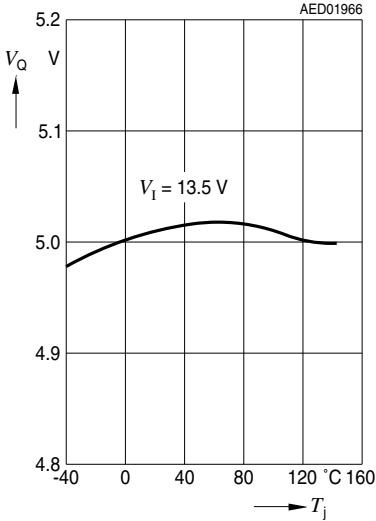

Current Consumption I_q versus Input Voltage V_I

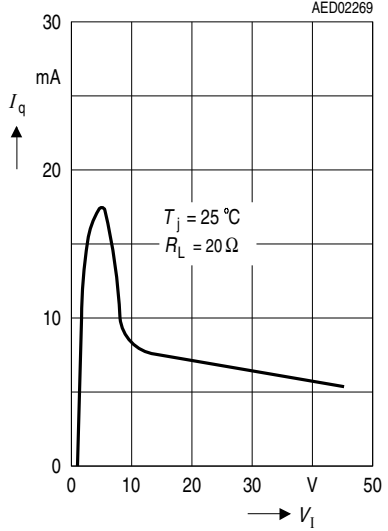

Output Voltage V_Q versus Input Voltage V_I

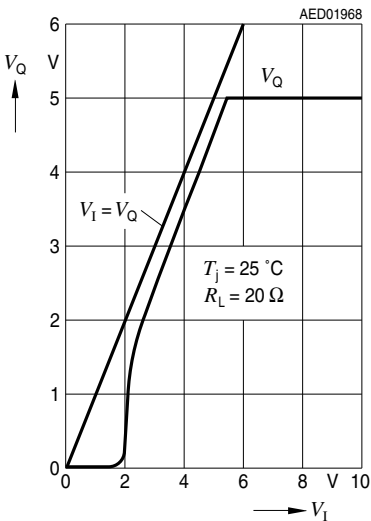

Input Current I_I versus Input Voltage V_I

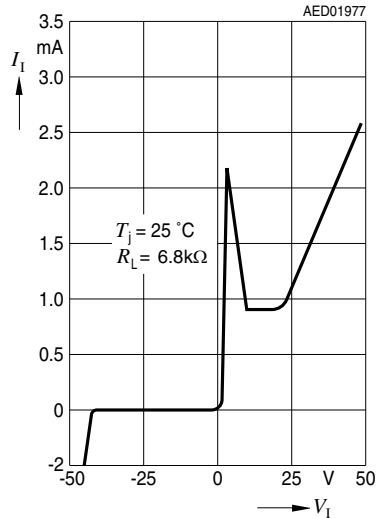

Typical Performance Characteristics for V85

Output Voltage V_Q versus Junction Temperature T_j

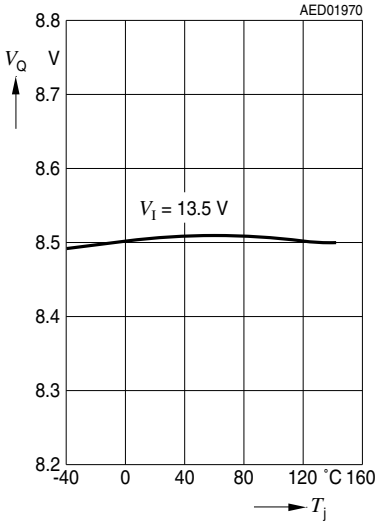

Current Consumption I_q versus Input Voltage V_i

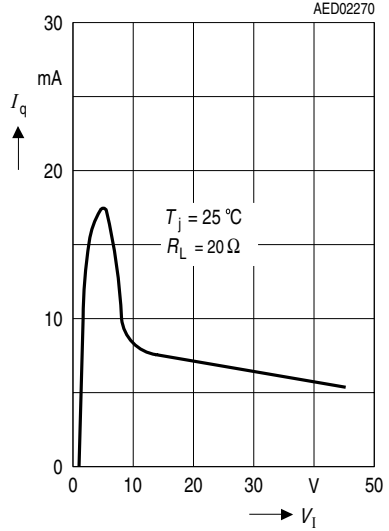

Output Voltage V_Q versus Input Voltage V_i

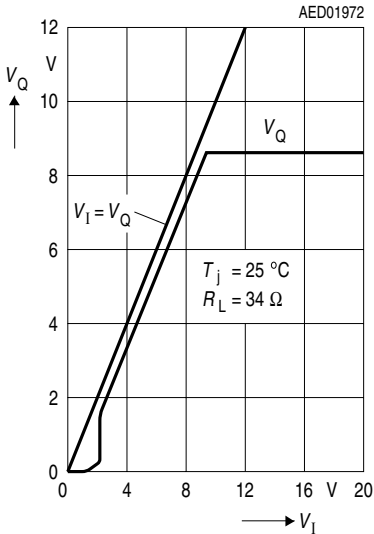

Input Current I_i versus Input Voltage V_i

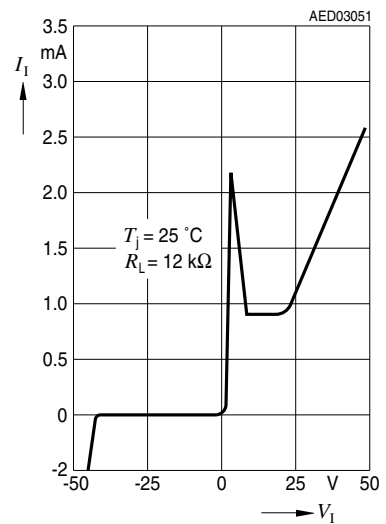

Typical Performance Characteristics for V10

Output Voltage V_Q versus Junction Temperature T_j

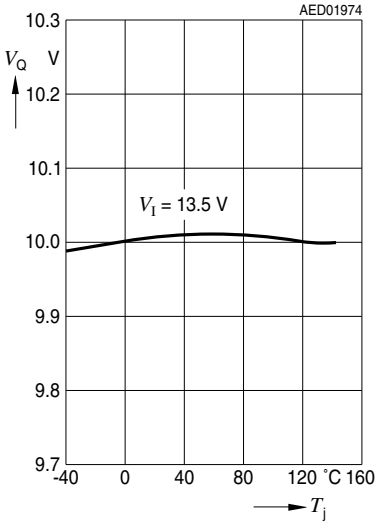

Current Consumption I_q versus Input Voltage V_I

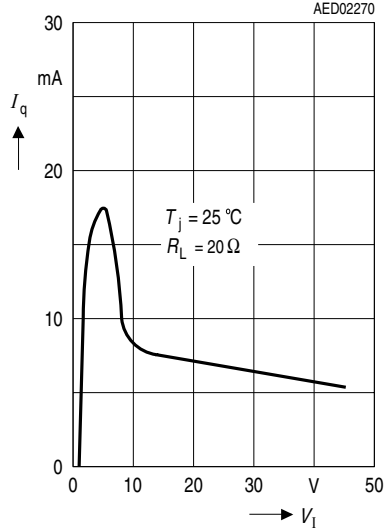

Output Voltage V_Q versus Input Voltage V_I

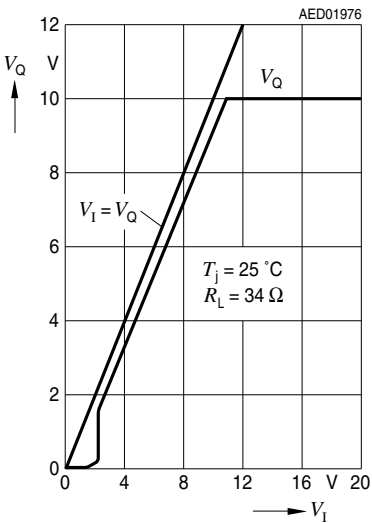

Input Current I_I versus Input Voltage V_I

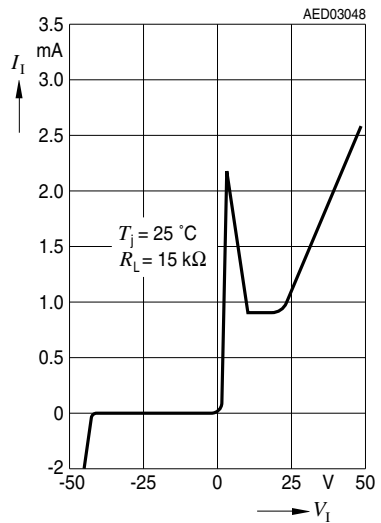

Package Outlines

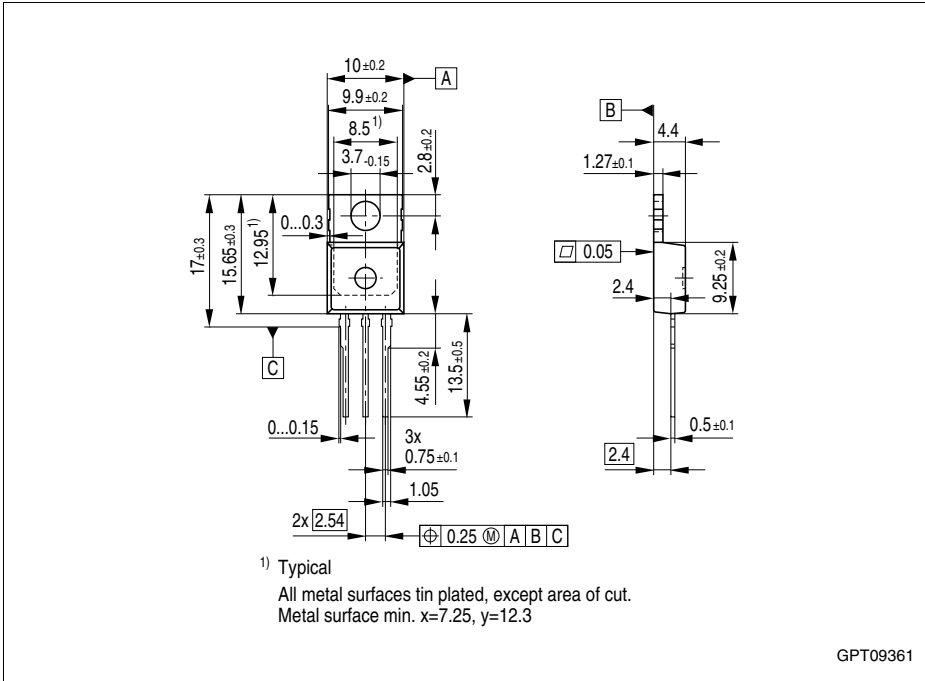

Figure 5 PG-TO220-3-1 (Plastic Transistor Single Outline)

Green Product (RoHS-Compliant)

To meet the world-wide customer requirements for environmentally friendly products and to be compliant with government regulations the device is available as a green product. Green products are RoHS-Compliant (i.e Pb-free finish on leads and suitable for Pb-free soldering according to IPC/JEDEC J-STD-020).

You can find all of our packages, sorts of packing and others in our Infineon Internet Page "Products": <http://www.infineon.com/products>.

SMD = Surface Mounted Device

Dimensions in mm

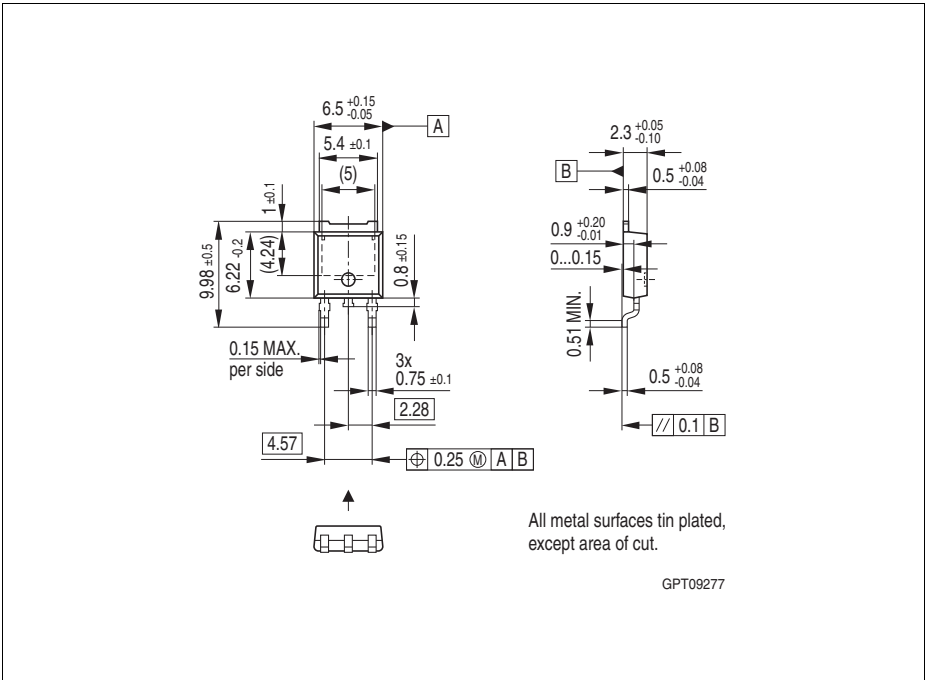

Figure 6 PG-TO252-3-11 (Plastic Transistor Single Outline)

Green Product (RoHS-Compliant)

To meet the world-wide customer requirements for environmentally friendly products and to be compliant with government regulations the device is available as a green product. Green products are RoHS-Compliant (i.e Pb-free finish on leads and suitable for Pb-free soldering according to IPC/JEDEC J-STD-020).

You can find all of our packages, sorts of packing and others in our Infineon Internet Page "Products": <http://www.infineon.com/products>.

SMD = Surface Mounted Device

Dimensions in mm

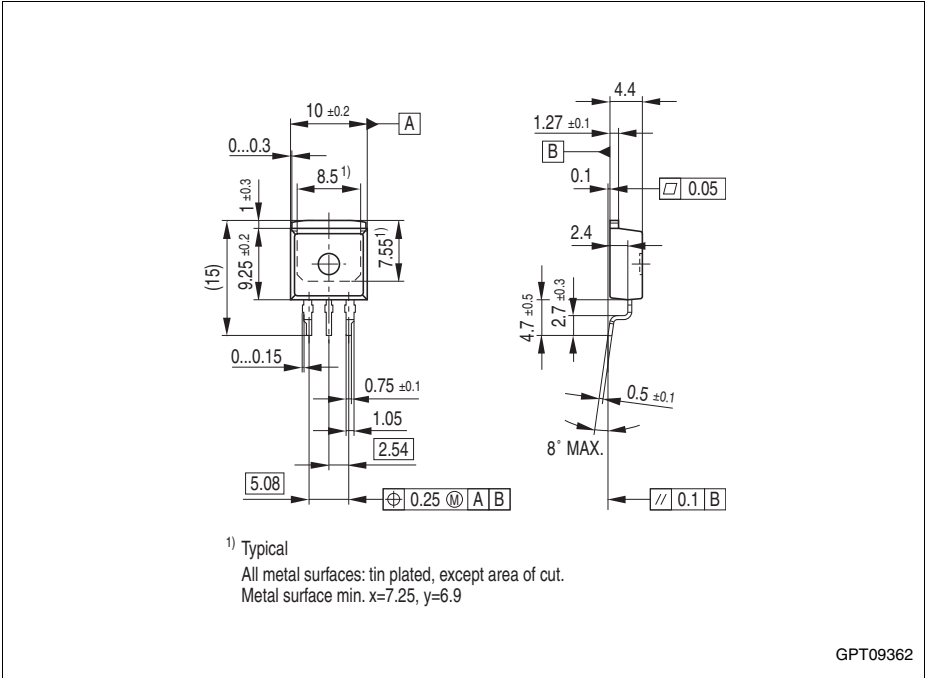

Figure 7 PG-TO263-3-1 (Plastic Transistor Single Outline)

Green Product (RoHS-Compliant)

To meet the world-wide customer requirements for environmentally friendly products and to be compliant with government regulations the device is available as a green product. Green products are RoHS-Compliant (i.e Pb-free finish on leads and suitable for Pb-free soldering according to IPC/JEDEC J-STD-020).

You can find all of our packages, sorts of packing and others in our Infineon Internet Page "Products": <http://www.infineon.com/products>.

SMD = Surface Mounted Device

Dimensions in mm

TLE 4274**Revision History:** **2011-01-20** Rev. 1.7

Previous Version: 1.5

Page	Subjects (major changes since last revision)
general	Updated Infineon logo
#1	Added "AEC" and "Green" logo
#1	Added "Green Product" and "AEC qualified" to the feature list
#1	Updated Package Names to "PG-xxx"
general	Removed leadframe variant "P-TO-252-1"
#12, #13, #14	Added "Green Product" remark
#16	Disclaimer Update
#17	Updated Package Outlines (added TAB potential)

Edition 2011-01-20

**Published by
Infineon Technologies AG
81726 München, Germany**

**© Infineon Technologies AG 2007.
All Rights Reserved.**

Legal Disclaimer

The information given in this document shall in no event be regarded as a guarantee of conditions or characteristics ("Beschaffheitsgarantie"). With respect to any examples or hints given herein, any typical values stated herein and/or any information regarding the application of the device, Infineon Technologies hereby disclaims any and all warranties and liabilities of any kind, including without limitation warranties of non-infringement of intellectual property rights of any third party.

Information

For further information on technology, delivery terms and conditions and prices please contact your nearest Infineon Technologies Office (www.infineon.com).

Warnings

Due to technical requirements components may contain dangerous substances. For information on the types in question please contact your nearest Infineon Technologies Office.

Infineon Technologies Components may only be used in life-support devices or systems with the express written approval of Infineon Technologies, if a failure of such components can reasonably be expected to cause the failure of that life-support device or system, or to affect the safety or effectiveness of that device or system. Life support devices or systems are intended to be implanted in the human body, or to support and/or maintain and sustain and/or protect human life. If they fail, it is reasonable to assume that the health of the user or other persons may be endangered.