

470MHz INPUT MIXER AND 455kHz FM IF DEMODULATOR IC

■ GENERAL DESCRIPTION

The **NJM2592** is a wide-operating voltage, low-current FM IF demodulator IC with 455kHz(standard) IF frequency. It includes an oscillator, mixer, limiting amplifier, quadrature detector, active filter, and FSK comparator.

The **NJM2592** also has a RSSI circuit and RSSI comparator for carrier sense.

■ PACKAGE OUTLINE

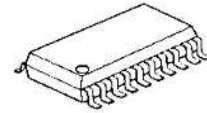

NJM2592V

■ FEATURES

- Wide Operating Voltage 1.8V to 9.0V
- Low Operating Current 2.2mA type. at $V^+ = 2.0V$, external local oscillator input
- Maximum Mixer Input Signal
 - Frequency 470MHz (reference value)
 - Level 0dBm
- Mixer Input Resistance 50Ω
- IF Frequency 455kHz (standard)
- Conventional Quadrature Detector
 - External Phase-shifting Capacitor
 - External Discriminator or LC Resonant Circuit
- RSSI Comparator with Open-Collector Output
- Quick Charge/Discharge Circuit for FSK Reference Voltage
- Bipolar Technology
- Package Outline SSOP20

■ BLOCK DIAGRAM

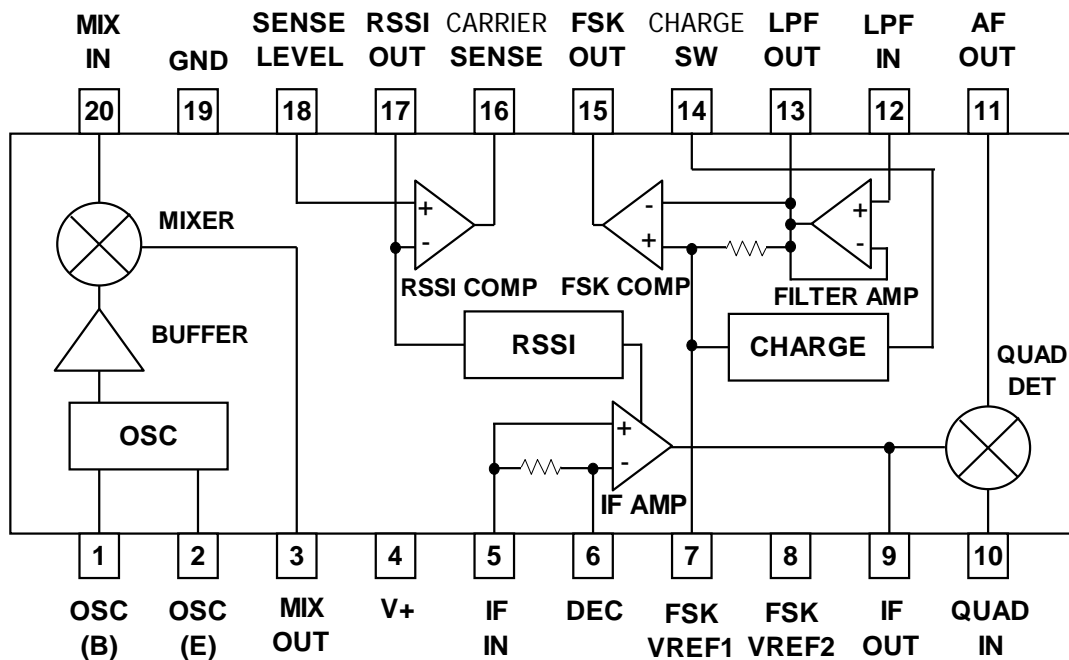

NJM2592

■ ABSOLUTE MAXIMUM RATINGS

(Ta=25°C)

PARAMETER	SYMBOL	RATINGS	UNIT
Supply Voltage	V ⁺	10.0	V
Power Dissipation	P _d	300	mW
Mixer Input Signal Level	V _{mixMAX}	0	dBm
Operating Temperature	T _{opr}	- 40 to +85	°C
Storage Temperature	T _{stg}	- 40 to +125	°C

■ RECOMMENDED OPERATING CONDITION

(Ta=25°C)

PARAMETER	SYMBOL	TEST CONDITIONS	MIN.	TYP.	MAX.	UNIT
Supply Voltage	V ⁺		1.8	2.5	9.0	V

■ ELECTRICAL CHARACTERISTICS

(Ta=25°C, V⁺=2.0V, f_{mix}=430MHz, f_{lo}=429.545MHz, f_{if}=455kHz, f_{mod}=600Hz, f_{dev}=±4kHz, unless otherwise noted)

PARAMETER	SYMBOL	TEST CONDITIONS	MIN.	TYP.	MAX.	UNIT
Current Consumption	I _{ccq}	No signal	1.8	2.2	2.8	mA
Mixer Conversion Gain	G _{mix}	V _{inMIX} =60dBuVEMF, Measured at Pin3, without IF filter, terminated with 2kΩ	16	20	24	dB
Mixer 3rd Order Intercept	IP3		-	95	-	dBuV
Mixer Input Resistance	R _{inM}		-	(50)	-	Ω
Mixer Input Capacitance	C _{inM}		-	(2.0)	-	pF
Mixer Output Resistance	R _{oM}		-	2.0	-	kΩ
Signal to Noise Ratio 1	S/N1	Mixer input V _{inMIX} =60dBuVEMF	-	60	-	dB
Signal to Noise Ratio 2	S/N2	IF input V _{inIF} =60dBuVEMF	-	60	-	dB
Signal to Noise Ratio 3	S/N3	IF input V _{inIF} =25dBuVEMF	-	30	-	dB
-3dB Limiting Sensitivity	V _{in(lim)}	IF input	-	22	-	dBuVEMF
AM Rejection Ratio	AMR	IF input, AM=30% V _{inIF} =60dBuVEMF	-	50	-	dB
IF Amplifier Input Resistance	R _{inIF}		-	2.0	-	kΩ
RSSI Output Voltage	V _{rssi}	IF input V _{inIF} =40dBuVEMF	(0.3)	0.45	(0.65)	V

The values shown in parenthesis are reference values.

PARAMETER	SYMBOL	TEST CONDITIONS	MIN.	TYP.	MAX.	UNIT
Demodulated Output Level	Vod	IF input VinIF =60dBuVEMF	75	85	95	mVrms
Duty Ratio of Wave Shaped Output	DR	IF Input VinIF=60dBuVEMF	40	50	60	%
Quick Charge/Discharge Current	Ich	FSK REF=GND LPFOUT=0.4V	35	65	110	uA
High Level Leak Current of CARRIER SENSE Terminal	IcryH	V _{CARRIER SENSE} =V ⁺	-	(0.0)	-	uA
Low Level Voltage of CARRIER SENSE Terminal	VcryL	I _{CARRIER SENSE} =100uA	-	0.1	0.4	V
Bias Current of SENSE LEVEL Terminal	Ilevel	V _{CARRIER SENSE} =0.8V	-	(0.0)	-	uA
High Level Leak Current of FSK OUT Terminal	IfskH	V _{FSK OUT} =V ⁺	-	(0.0)	-	uA
Low Level Voltage of FSK OUT Terminal	VfskL	I _{FSK OUT} =100uA	-	0.1	0.4	dB

The values shown in parenthesis are reference values.

■ TEST CIRCUIT

This test circuit allows the measurement of all parameters described in "ELECTRICAL CHARACTERISTICS". This test circuit includes some electrical switches that should be in the suitable position for the measurement of each parameter.

● Circuit diagram

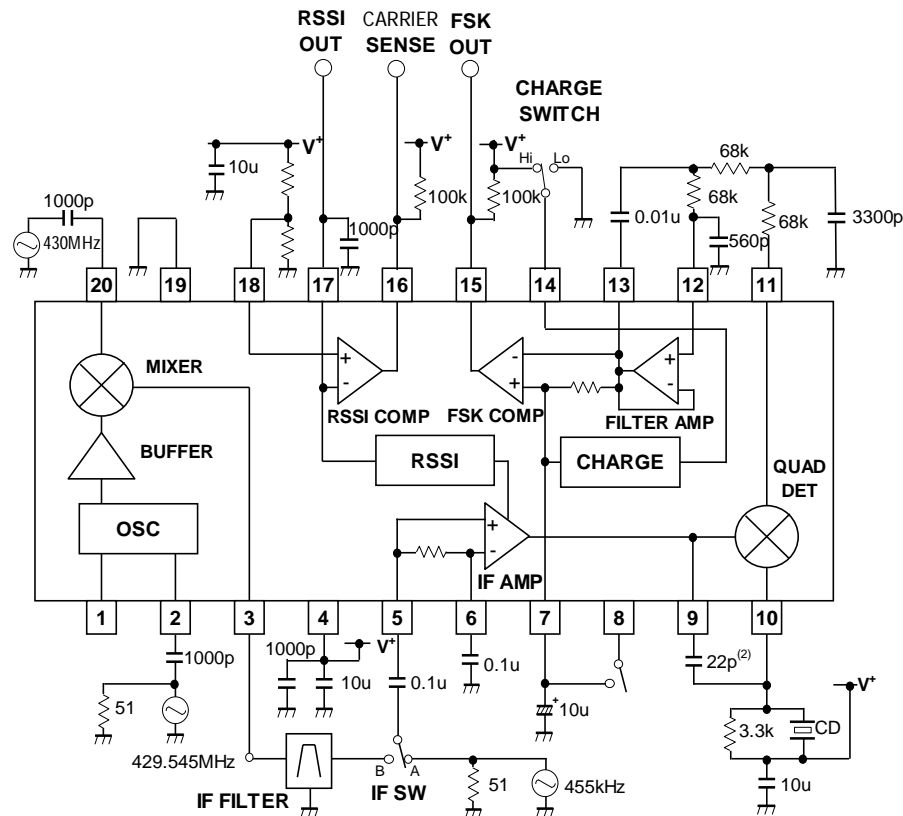

● External components

- C D : Ceramic Discriminator, 455kHz
- IF FILTER : Ceramic Filter, 455kHz

● Measurement condition

"Condition 1" is the condition for the case of IF input :

- IF SW : in the A position.
- IF IN input signal : input frequency(f_{if}) = 455kHz, input level(V_{inIF}) = 60dBuVEMF, modulation frequency(f_{mod}) = 600Hz, deviation $f_{dev} = \pm 4$ kHz

"Condition 2" is the condition for the case of Mixer Input :

- IF SW : in the B position
- MIX IN input signal: input frequency(f_{mix}) = 430MHz, input level(V_{inMIX}) = 60dBuVEMF, modulation frequency(f_{mod}) = 600Hz, deviation $f_{dev} = \pm 4$ kHz
- OSC(E) input signal: input frequency(f_{osc}) = 429.545MHz, input level(V_{inOSC}) = 105dBuVEMF

■ **TERMINAL FUNCTION** ($T_a=25^\circ\text{C}$, $V^+=2.0\text{V}$)

Pin No.	SYMBOL	EQUIVALENT CIRCUIT	VOLTAGE	FUNCTION
1	OSC (B)		-	Base / Emitter Terminal Colpitts - type oscillator is formed with an external oscillator element of crystal unit or SAW resonator. Output of an external oscillator circuit can also input to pin1 or pin2.
2	OSC (E)		-	
3	MIX OUT		1.1V	Mixer Output An external 455kHz ceramic filter is connected. The typical output impedance is 2kΩ.
4	V+		-	Supply Voltage
5	IF IN		1.94V	IF Limiter Amplifier Input This is an input to the IF amplifier after passing through 455kHz ceramic filter. The typical input impedance is 2kΩ.
6	DEC		1.94V	IF Decoupling An external decoupling capacitor is connected to enhance stability.
7	FSK VREF1		0.55V	FSK Reference Input This pin is an input of reference voltage for FSK comparator. An external capacitor is connected to create an average DC level of FM demodulated signal. The choice of this capacitor is dependent on the speed of data signal. A quick charge/discharge circuit offers the voltage of pin 7 comes the same voltage of pin 11 quickly.

NJM2592

Pin No.	SYMBOL	EQUIVALENT CIRCUIT	VOLTAGE	FUNCTION
8	FSK VREF2		0.55V	FSK Reference Voltage Output This pin usually keeps open. This fixed output voltage may be available for the FSK reference voltage of wave shaping comparator by connecting to pin7. This usage is effective in shaping the data signal with continuous bits of the same polarity, and discussed in another document related to applications information.
9	IF OUT		1.19V	IF Output An external phase - shifting capacitor is connected between pin9 and pin10.
10	QUAD IN		1.99V	Quadrature Detector Input An external phase - shifting coil or ceramic discriminator is connected.
11	AF OUT		0.55V	FM Demodulated Signal Output An external 3rd order multiple feed - back filter (RC filter) is connected between pin11 and pin13.

Pin No.	SYMBOL	EQUIVALENT CIRCUIT	VOLTAGE	FUNCTION
12	LPF IN		0.55V	Low Pass Filter Input An external RC components forms a band pass filter between pin12 and pin13. This terminal is biased from pin 11 through an external RC filter.
13	LPF OUT		0.55V	Low Pass Filter Output
14	CHARGE SW		--	Quick Charge / Discharge Control The power supply output voltage to pin 14 sets up the quick charge / discharge circuit. Hi : ON Low : OFF Instead of V+, another power source can also be used within the limit of the rated supply voltage.
15	FSK OUT		--	FSK Output The FSK comparator is a wave shaping circuit. A Filter Amplifier output signal is inverted and wave shaped. Instead of V+, another power source can also be used within the limit of the rated supply voltage.
16	CARRIER SENSE		--	Carrier Sense Output This pin outputs the result of RSSI comparator by comparing RSSI output level with an external input level to pin 18.

Pin No.	SYMBOL	EQUIVALENT CIRCUIT	VOLTAGE	FUNCTION
17	RSSI OUT		0.05V	Received Signal Strength Indicator Output Pin 11 outputs DC level proportional to the log of input signal level to pin 20.
18	SENSE LEVEL		--	Sense Level Input External reference voltage of RSSI comparator
19	GND		--	Ground
20	MIX IN		0.27V	Mixer Input The mixer is designed to work up to 470MHz with the typical input impedance of $R_{inM} = 50\Omega$ and $C_{inM} = 2pF$ (at 430MHz).

Note :

- ESD protection diodes exist between each of the following pins and V^+ .
Pin 1,2,3,5,6,7,8,9,10,11,12,13,17,18,20
- ESD protection diodes also exist between each of the following pins and ground.
Pin 1,2,3,5,6,7,8,9,10,11,12,13,14,15,16,17,18

APPLICATION CIRCUIT

External Local Oscillator Signal Input

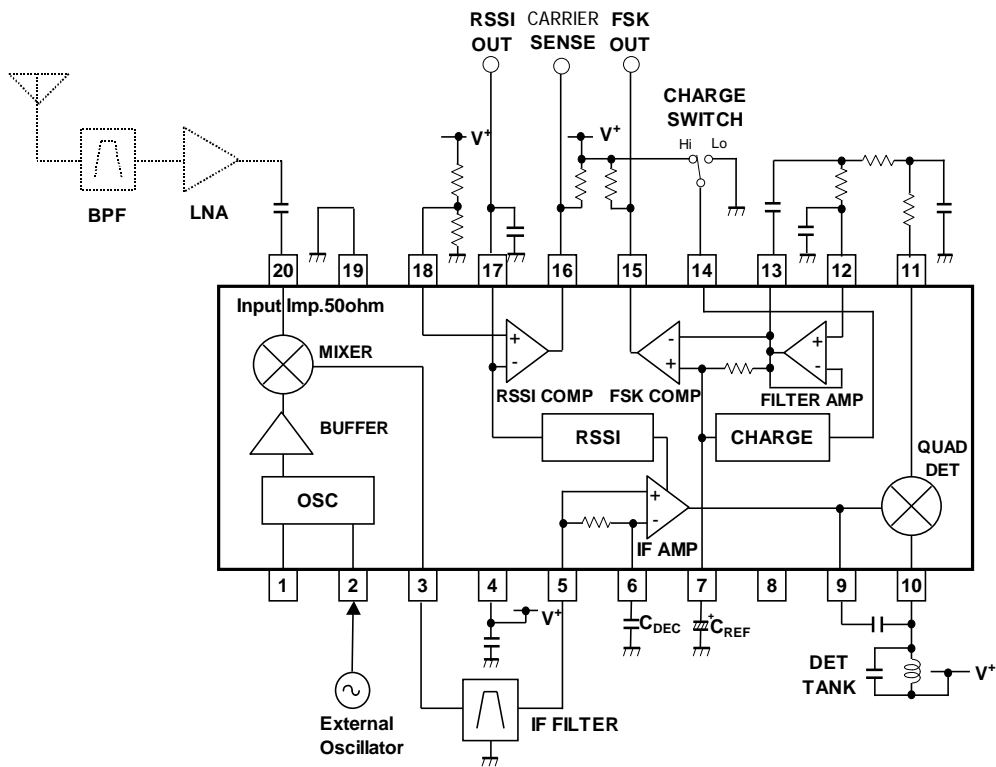

Local Oscillator with External Crystal and LC Resonant Elements

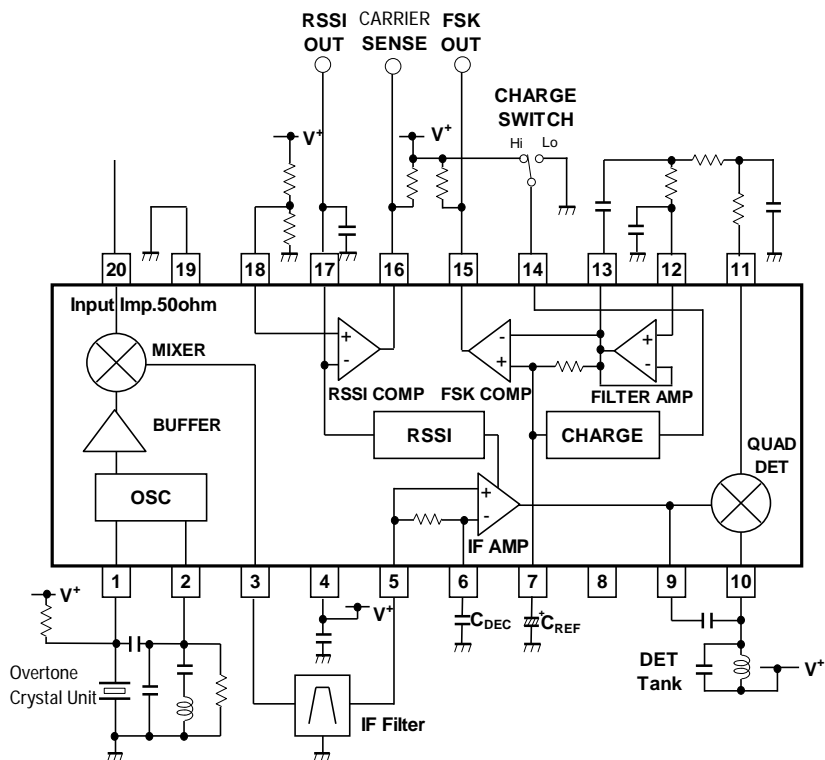

■ EVALUATION PC BOARD

The evaluation board is useful for your design and to have more understanding of the usage and performance of this device. This circuit is the same as TEST CIRCUIT. Note that this board is not prepared to show the recommendation of pattern and parts layout.

● Circuit Diagram

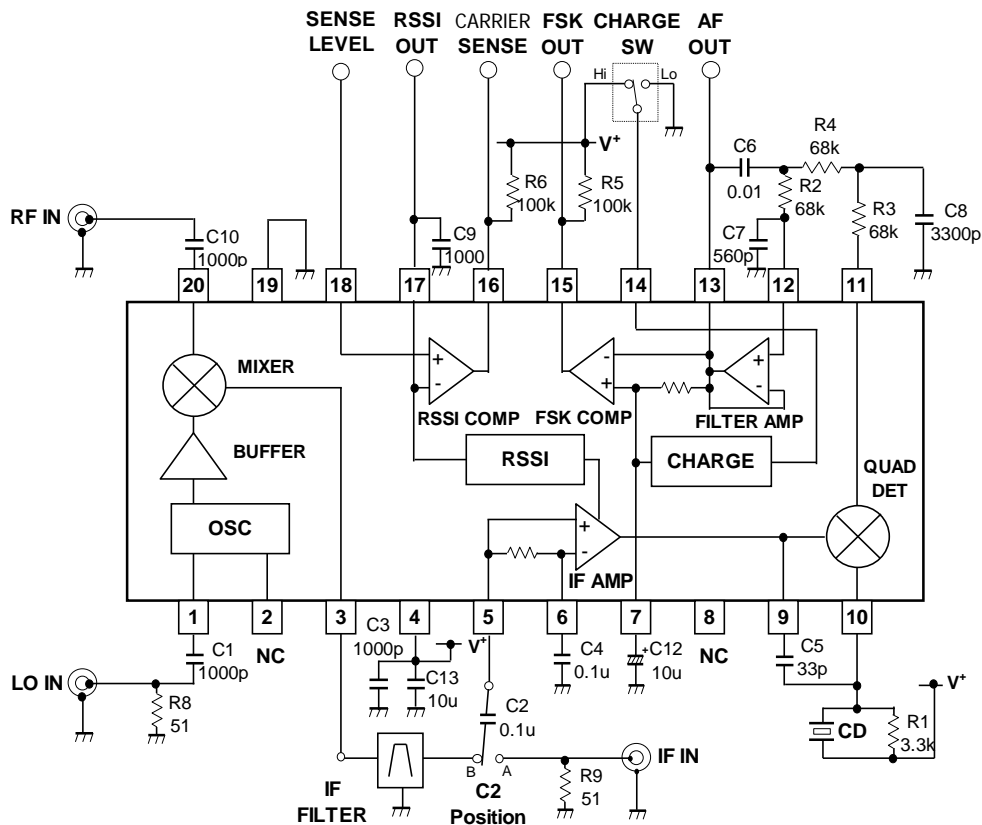

Note:

1. This board is designed for mixer-input type and C2 is factory-configured as follows:
C2 : in the B position
For the case of IF-input type, the position of C2 is necessary to change as follows:
C2 : in the A position
The actual position of C2 is shown in the next page.
2. External components
CD : Ceramic Discriminator, 455kHz
IF FILTER : Ceramic Filter, 455kHz

● Circuit Side View

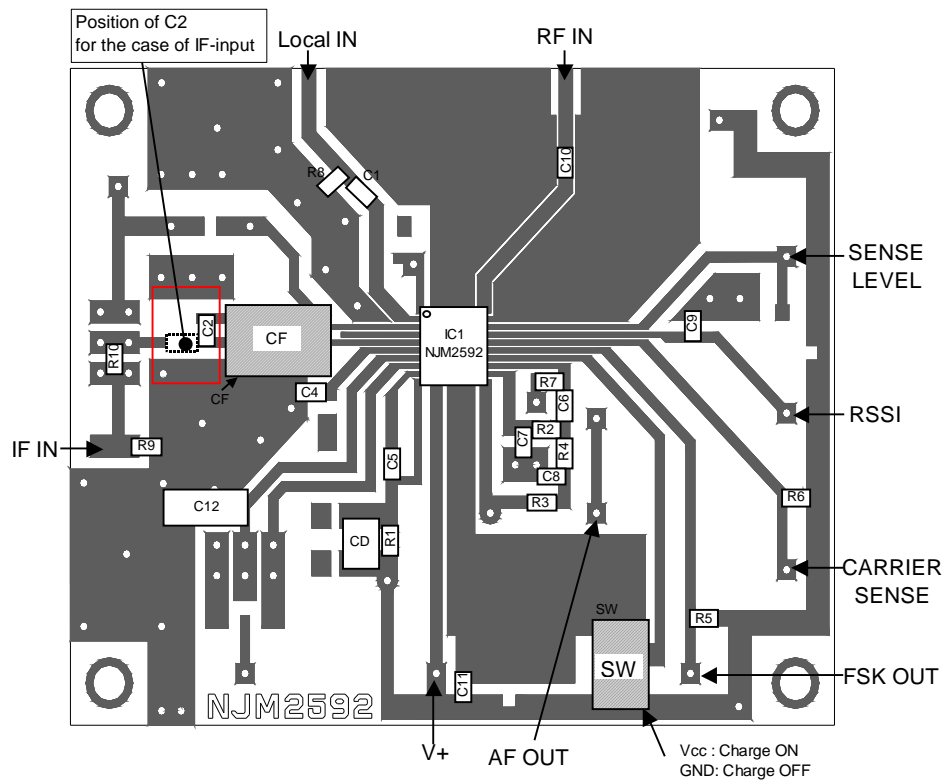

● Ground Side View

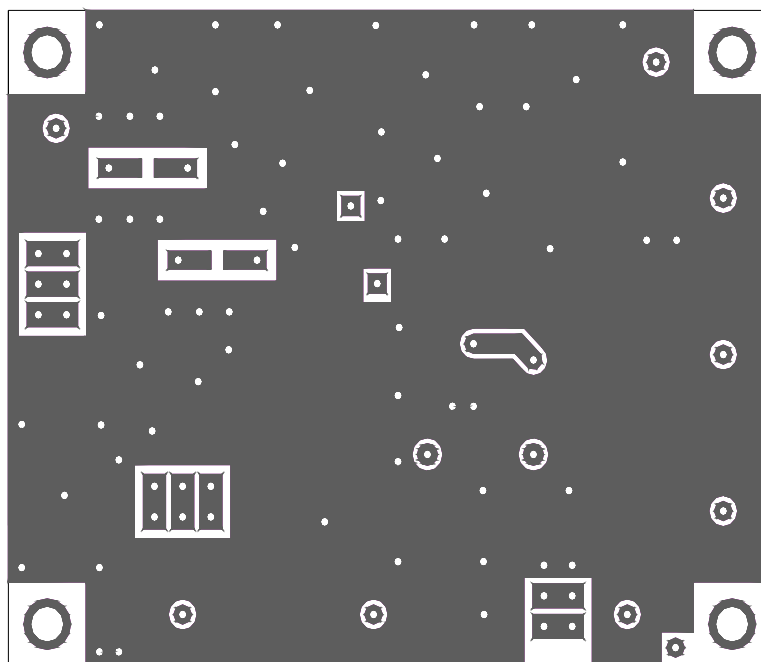

Note:

1. External Components

- C1, C3, C9, C10=1000pF C2, C4=0.1uF C5=33pF C6=0.01uF C7=560p C8=3300pF
 C11=0.47uF C12, C13=10uF
 R1=3.3kΩ R2, R3, R4=68kΩ R5, R6=100kΩ R7, R10=0Ω R8, R9=51Ω
 CF : Ceramic Filter, 455kHz
 CD : Ceramic Discriminator, 455kHz

■ TYPICAL CHARACTERISTICS (Ta=25°C, V+=2.0V, unless otherwise noted)

Current Consumption versus Supply Voltage

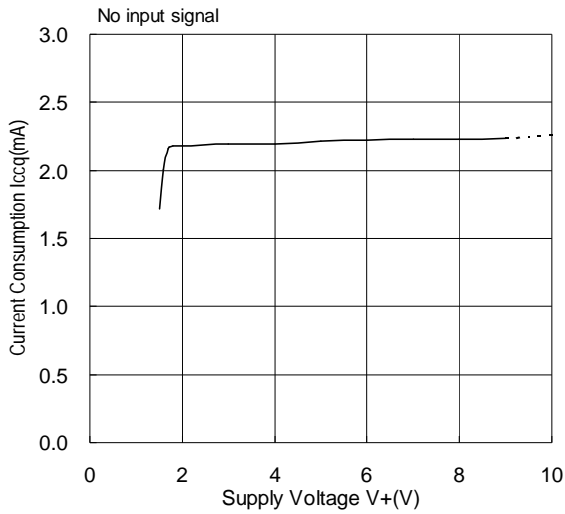

Mixer Conversion Gain versus Supply Voltage

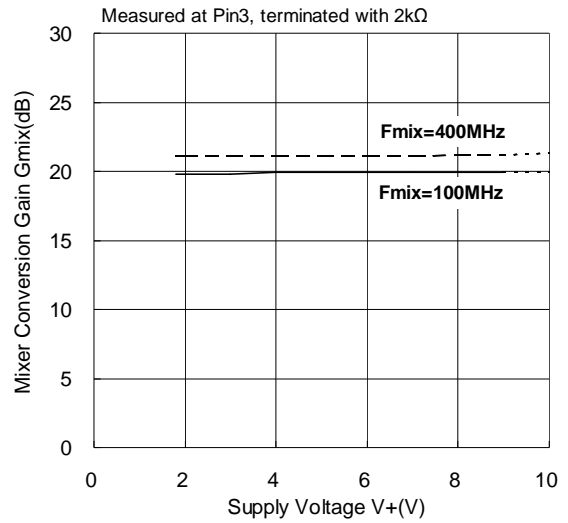

Demodulated Output versus Supply Voltage

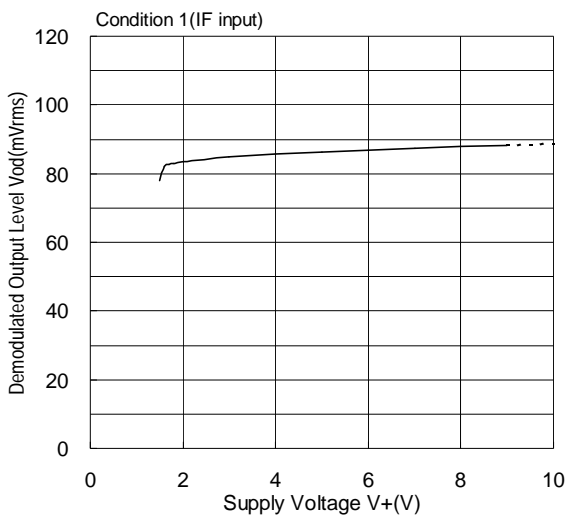

FSK Duty Ratio versus Supply Voltage

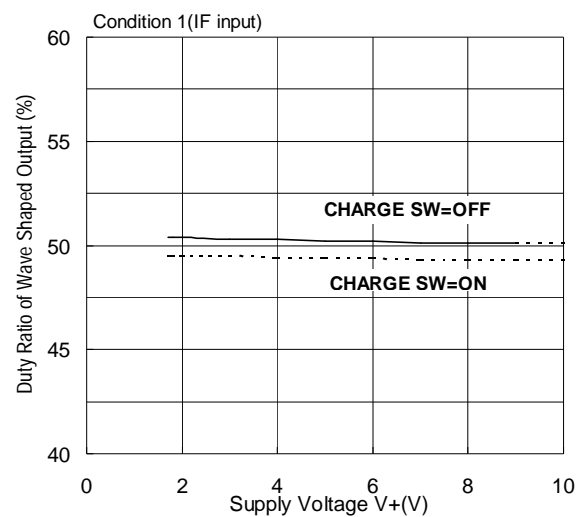

S/N versus Supply Voltage-Mixer Input-

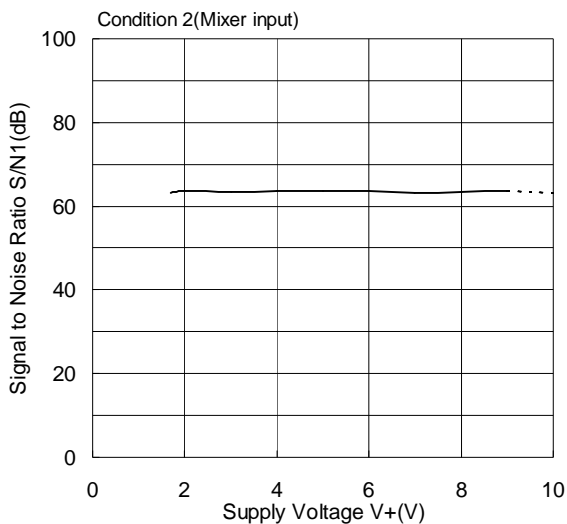

-3dB Limiting Sensitivity versus Supply Voltage

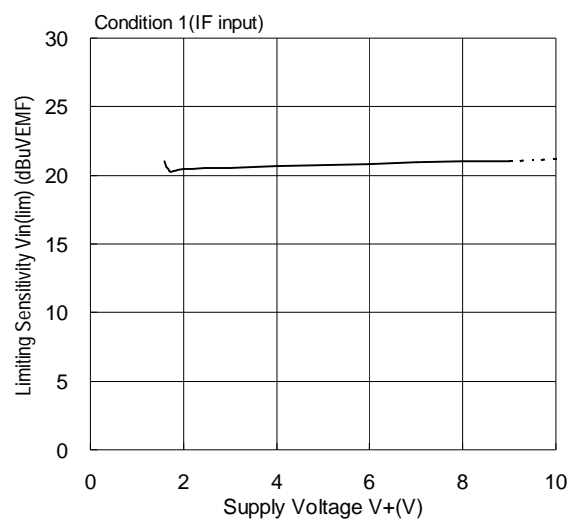

Mixer Conversion Gain versus Frequency

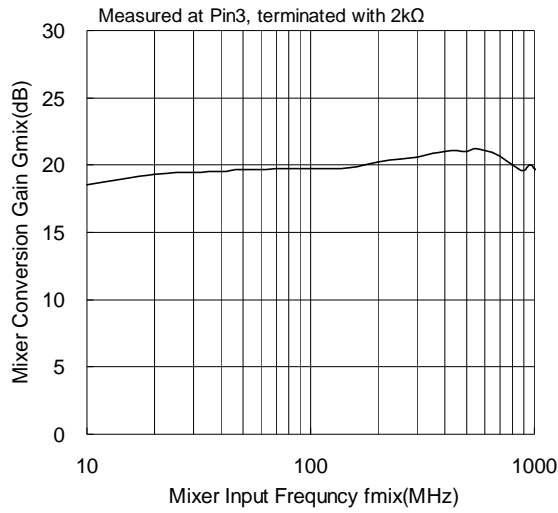

Mixer Input Level Characteristics

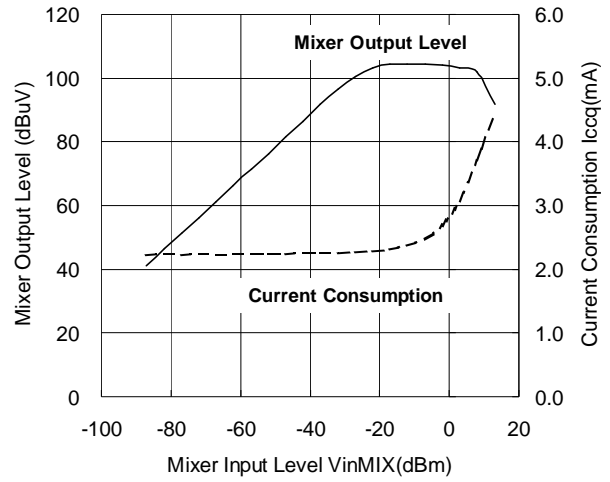

Mixer Conversion Gain versus OSC Input

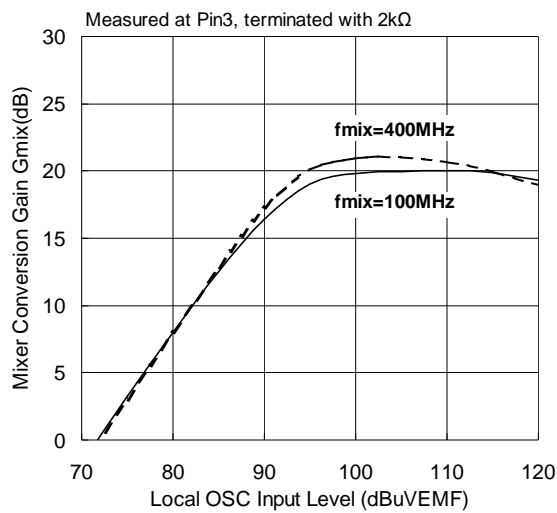

AF Output versus Frequency:S-Curve

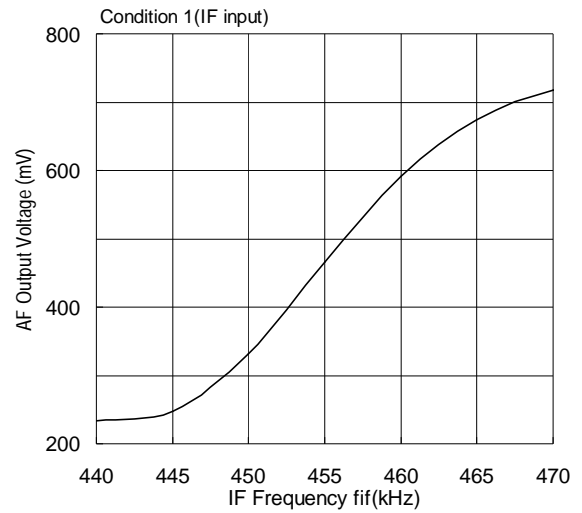

IF Detuning Characteristics

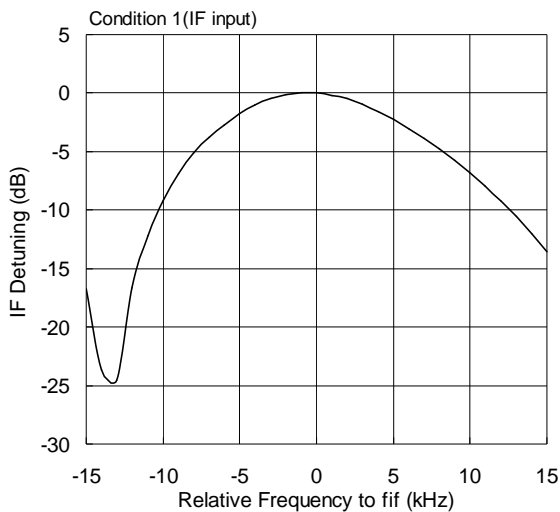

Carrier Sense Characteristics

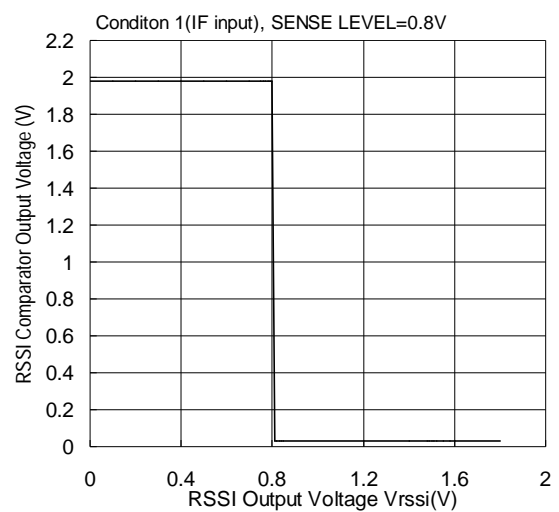

S+N,N,AMR versus Mixer Input

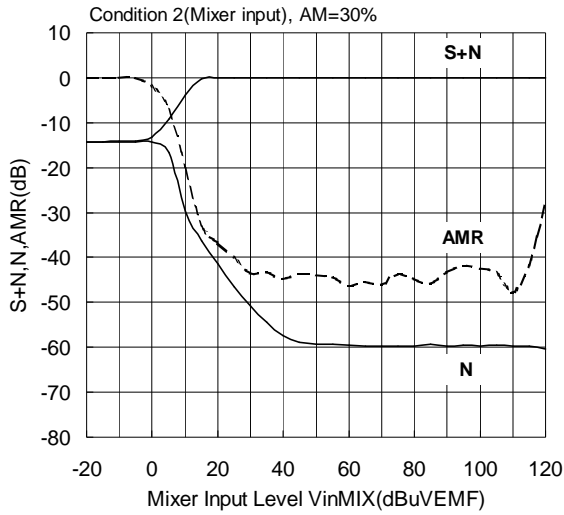

S+N,N,AMR versus IF Input

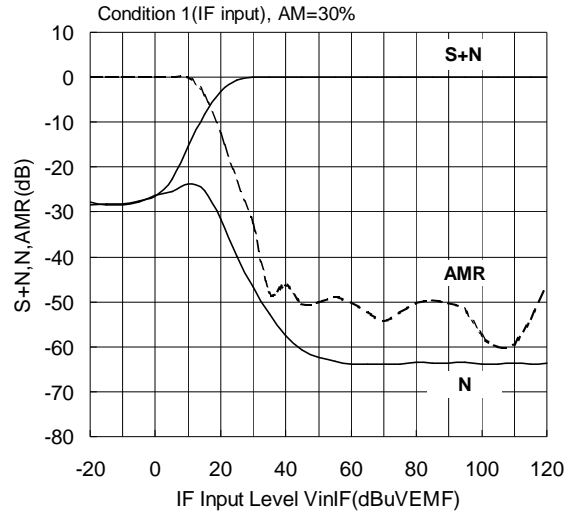

RSSI Output versus Mixer Input

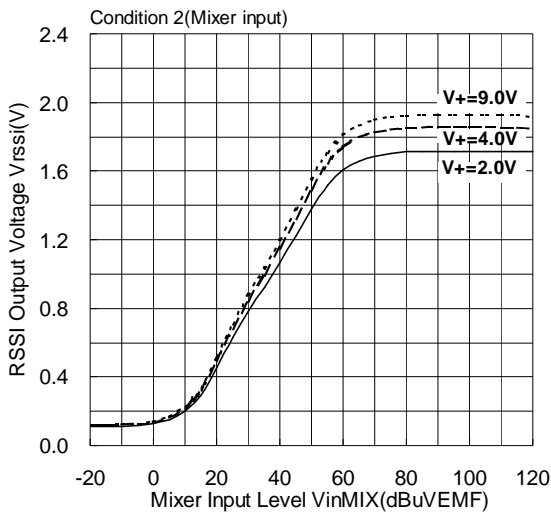

RSSI Output versus IF Input

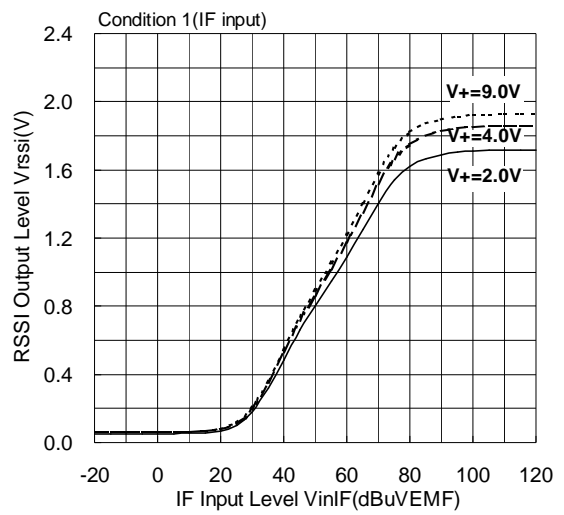

Quick Charge/Discharge Current versus FSK Reference Input Voltage

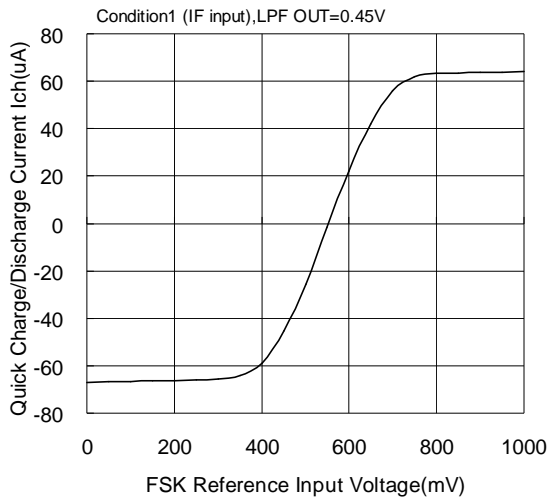

Current Consumption versus Temperature

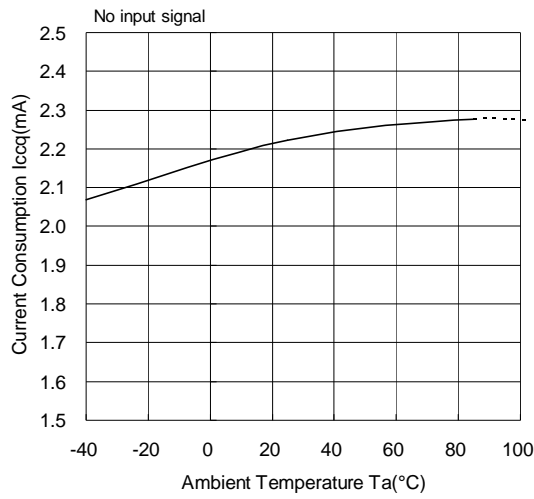

Mixer Conversion Gain versus Temperature

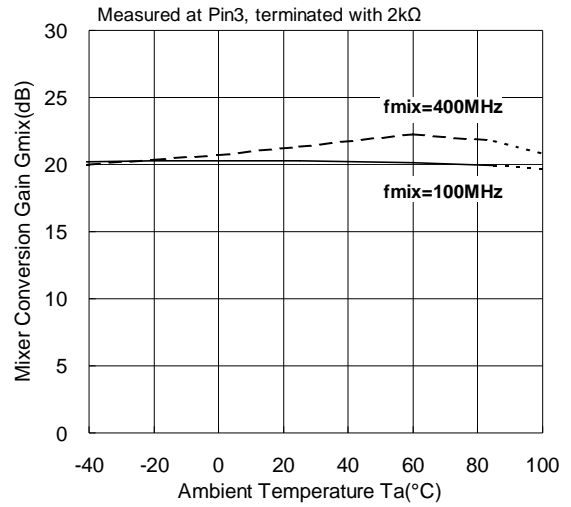

Demodulated Output versus Temperature

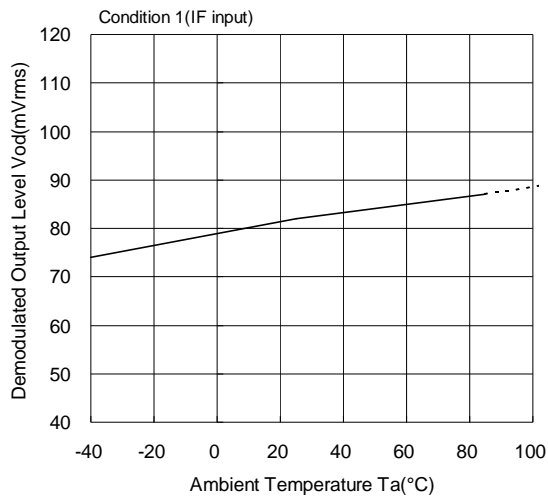

FSK Duty Ratio versus Temperature

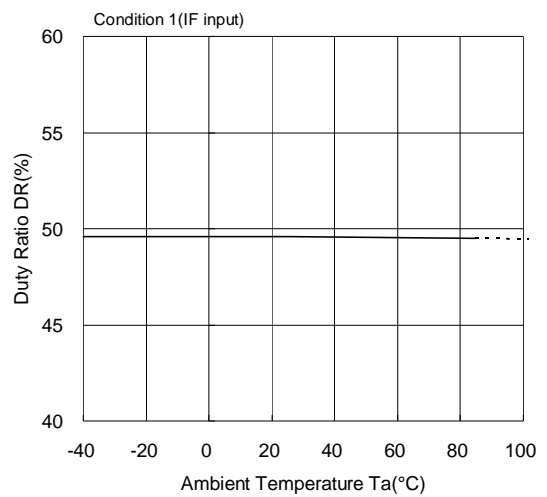

S/N versus Temperature

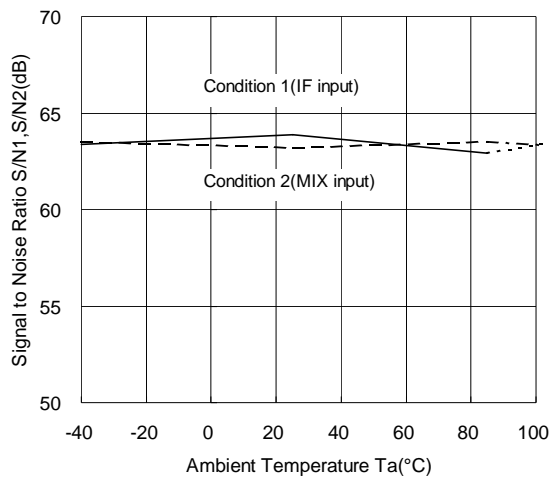

-3dB Limiting Sensitivity versus Temperature

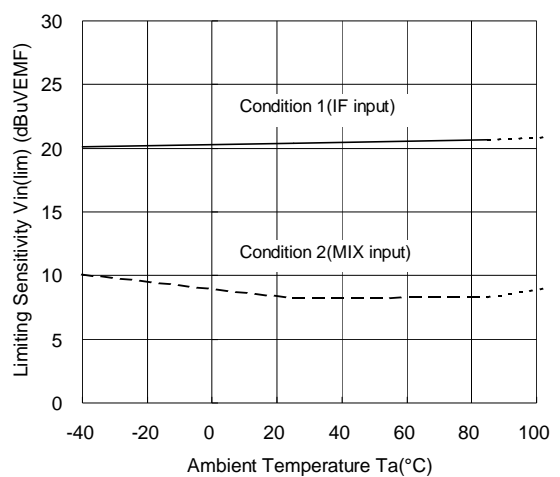

RSSI Output versus Temperature-Mixer-

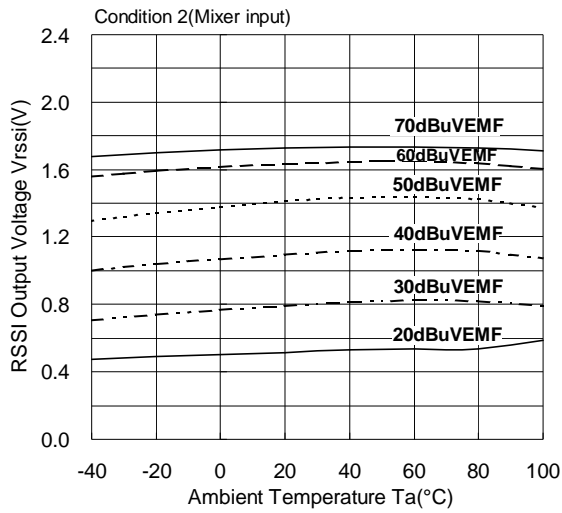

RSSI Output versus Temperature-IF-

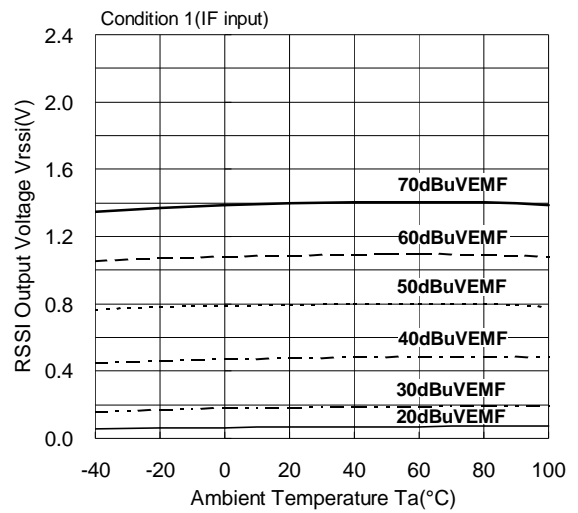

Quick Charge/Discharge Current versus Temperature

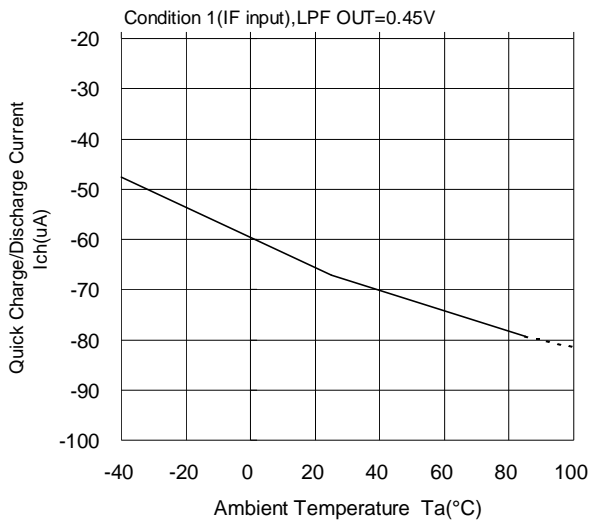

[CAUTION]
 The specifications on this databook are only given for information, without any guarantee as regards either mistakes or omissions. The application circuits in this databook are described only to show representative usages of the product and not intended for the guarantee or permission of any right including the industrial rights.