

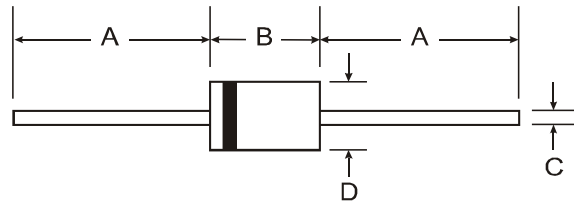

Features

- Diffused Junction
- Ultra-Fast Switching for High Efficiency
- Surge Overload Rating to 150A Peak
- Low Reverse Leakage Current
- **Lead-Free Finish; RoHS Compliant (Notes 1 & 2)**



Mechanical Data

- Case: DO-201AD
- Case Material: Molded Plastic. UL Flammability Classification Rating 94V-0
- Moisture Sensitivity: Level 1 per J-STD-020C
- Terminals: Finish—Tin. Plated Leads Solderable per MIL-STD-202, Method 208
- Polarity: Cathode Band
- Marking: Type Number
- Ordering Information: See Last Page
- Weight: 1.1 grams (Approximate)

DO-201AD		
Dim	Min	Max
A	25.40	—
B	7.20	9.50
C	1.20	1.30
D	4.80	5.30
All Dimensions in mm		

Maximum Ratings and Electrical Characteristics @T_A = 25°C unless otherwise specified

Single phase, half wave, 60Hz, resistive or inductive load.
For capacitive load, derate current by 20%.

Characteristic	Symbol	UF 3001	UF 3002	UF 3003	UF 3004	UF 3005	UF 3006	UF 3007	Unit
Peak Repetitive Reverse Voltage	V _{RRM}								
Working Peak Reverse Voltage	V _{RWM}	50	100	200	400	600	800	1000	V
DC Blocking Voltage (Note 6)	V _R								
RMS Reverse Voltage	V _{R(RMS)}	35	70	140	280	420	560	700	V
Average Rectified Output Current (Note 3)	I _o	3.0							A
Non-Repetitive Peak Forward Surge Current 8.3ms Single Half Sine-Wave Superimposed on Rated Load	I _{FSM}	150							A
Forward Voltage @ I _F = 3.0A	V _{FM}	1.0		1.3		1.7			V
Peak Reverse Current at Rated DC Blocking Voltage (Note 6)	I _{RM}	5.0							μA
		100							
Reverse Recovery Time (Note 5)	t _{rr}	50			75				ns
Typical Total Capacitance (Note 4)	C _T	75			50				pF
Typical Thermal Resistance Junction to Ambient	R _{θJA}	35							°C/W
Operating and Storage Temperature Range	T _j , T _{STG}	-65 to +150							°C

- Notes:
1. EU Directive 2002/95/EC (RoHS), 2011/65/EU (RoHS 2) & 2015/863/EU (RoHS 3).compliant. All applicable RoHS exemptions applied.
 2. See <https://www.diodes.com/quality/lead-free/> for more information about Diodes Incorporated's definitions of Halogen- and Antimony-free, "Green" and Lead-free.
 3. Valid provided that leads are maintained at ambient temperature at a distance of 9.5mm from the case.
 4. Measured at 1.0MHz and applied reverse voltage of 4.0V DC.
 5. Measured with I_F = 0.5A, I_R = 1.0A, I_{rr} = 0.25A. See Figure 5.
 6. Short duration pulse test used to minimize self-heating effect.

OBSOLETE – PART DISCONTINUED

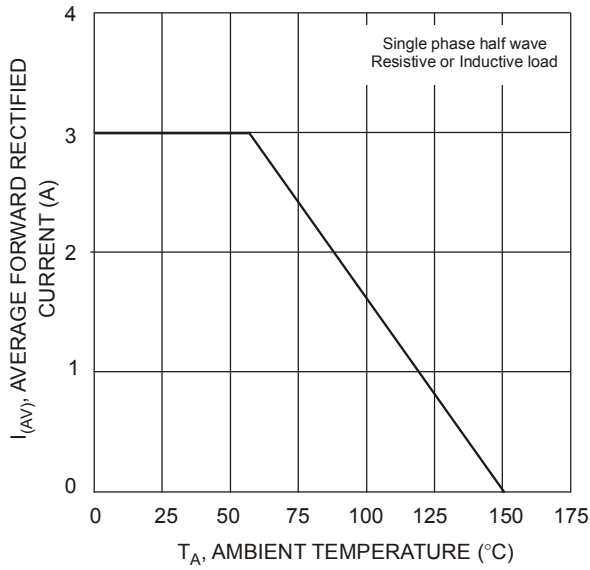

Fig. 1 Forward Current Derating Curve

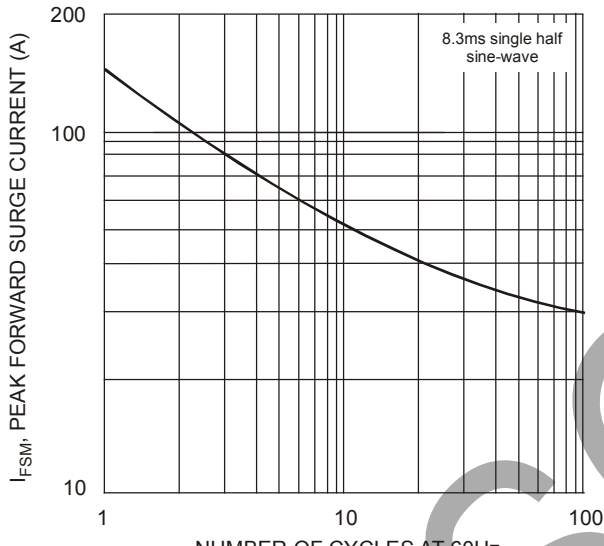

Fig. 3 Peak Forward Surge Current

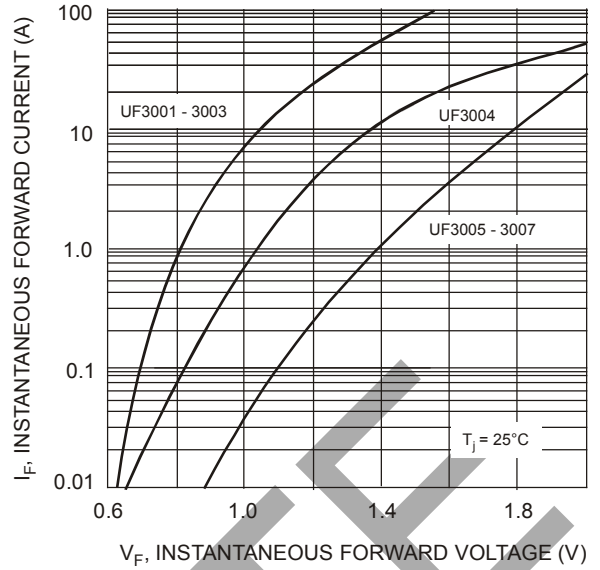

Fig. 2 Typical Forward Characteristics

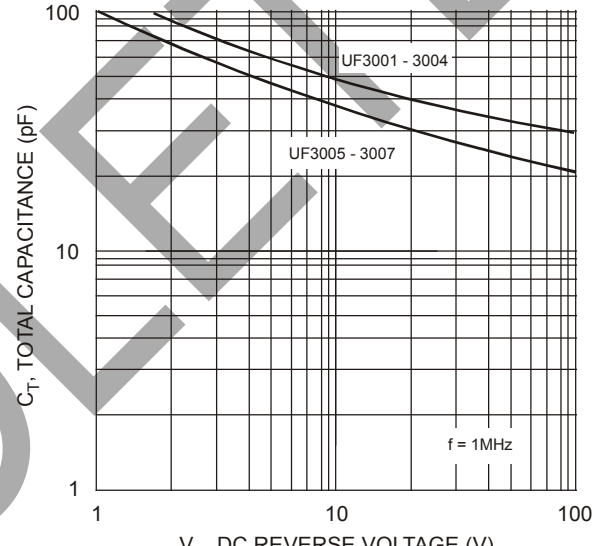
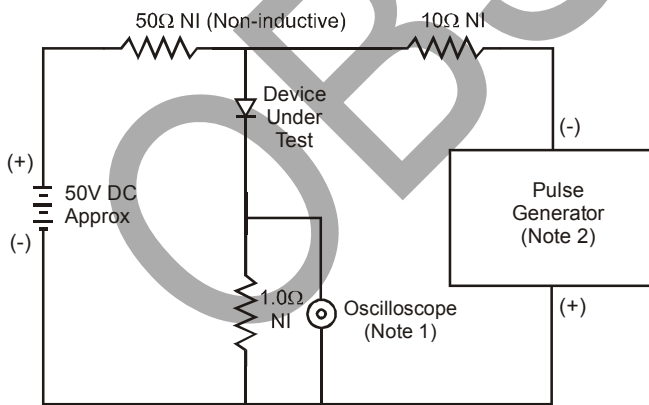
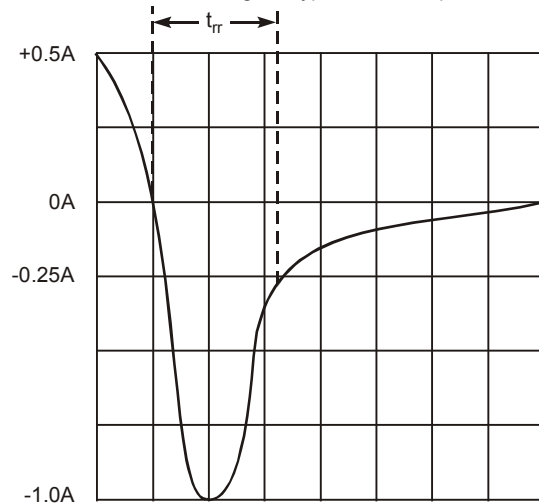

Fig. 4 Typical Total Capacitance



- Notes:
- Rise Time = 7.0ns max. Input Impedance = 1.0MΩ, 22pF.
 - Rise Time = 10ns max. Input Impedance = 50Ω.



Set time base for 50/100 ns/cm

Fig. 5 Reverse Recovery Time Characteristic and Test Circuit

Ordering Information (Note 6)

Device	Packaging	Shipping
UF3001-B	DO-201AD	500/Bulk
UF3001-T	DO-201AD	1.2K/Tape & Reel, 13-inch
UF3002-B	DO-201AD	500/Bulk
UF3002-T	DO-201AD	1.2K/Tape & Reel, 13-inch
UF3003-B	DO-201AD	500/Bulk
UF3003-T	DO-201AD	1.2K/Tape & Reel, 13-inch
UF3004-B	DO-201AD	500/Bulk
UF3004-T	DO-201AD	1.2K/Tape & Reel, 13-inch
UF3005-B	DO-201AD	500/Bulk
UF3005-T	DO-201AD	1.2K/Tape & Reel, 13-inch
UF3006-B	DO-201AD	500/Bulk
UF3006-T	DO-201AD	1.2K/Tape & Reel, 13-inch
UF3007-B	DO-201AD	500/Bulk
UF3007-T	DO-201AD	1.2K/Tape & Reel, 13-inch

Notes: 7. For packaging details, visit our website at <http://www.diodes.com/package-outlines.html>.

OBSOLETE – PART DISCONTINUED

OBSOLETE

IMPORTANT NOTICE

DIODES INCORPORATED MAKES NO WARRANTY OF ANY KIND, EXPRESS OR IMPLIED, WITH REGARDS TO THIS DOCUMENT, INCLUDING, BUT NOT LIMITED TO, THE IMPLIED WARRANTIES OF MERCHANTABILITY AND FITNESS FOR A PARTICULAR PURPOSE (AND THEIR EQUIVALENTS UNDER THE LAWS OF ANY JURISDICTION).

Diodes Incorporated and its subsidiaries reserve the right to make modifications, enhancements, improvements, corrections or other changes without further notice to this document and any product described herein. Diodes Incorporated does not assume any liability arising out of the application or use of this document or any product described herein; neither does Diodes Incorporated convey any license under its patent or trademark rights, nor the rights of others. Any Customer or user of this document or products described herein in such applications shall assume all risks of such use and will agree to hold Diodes Incorporated and all the companies whose products are represented on Diodes Incorporated website, harmless against all damages.

Diodes Incorporated does not warrant or accept any liability whatsoever in respect of any products purchased through unauthorized sales channel. Should Customers purchase or use Diodes Incorporated products for any unintended or unauthorized application, Customers shall indemnify and hold Diodes Incorporated and its representatives harmless against all claims, damages, expenses, and attorney fees arising out of, directly or indirectly, any claim of personal injury or death associated with such unintended or unauthorized application.

Products described herein may be covered by one or more United States, international or foreign patents pending. Product names and markings noted herein may also be covered by one or more United States, international or foreign trademarks.

This document is written in English but may be translated into multiple languages for reference. Only the English version of this document is the final and determinative format released by Diodes Incorporated.

LIFE SUPPORT

Diodes Incorporated products are specifically not authorized for use as critical components in life support devices or systems without the express written approval of the Chief Executive Officer of Diodes Incorporated. As used herein:

A. Life support devices or systems are devices or systems which:

1. are intended to implant into the body, or
2. support or sustain life and whose failure to perform when properly used in accordance with instructions for use provided in the labeling can be reasonably expected to result in significant injury to the user.

B. A critical component is any component in a life support device or system whose failure to perform can be reasonably expected to cause the failure of the life support device or to affect its safety or effectiveness.

Customers represent that they have all necessary expertise in the safety and regulatory ramifications of their life support devices or systems, and acknowledge and agree that they are solely responsible for all legal, regulatory and safety-related requirements concerning their products and any use of Diodes Incorporated products in such safety-critical, life support devices or systems, notwithstanding any devices- or systems-related information or support that may be provided by Diodes Incorporated. Further, Customers must fully indemnify Diodes Incorporated and its representatives against any damages arising out of the use of Diodes Incorporated products in such safety-critical, life support devices or systems.

Copyright © 2019, Diodes Incorporated

www.diodes.com