

ANT-W63-IPW1-NP WiFi 6 Outdoor Whip Antenna

The Linx ANT-W63-IPW1-NP antenna is an outdoor IP67-rated dipole antenna designed for superior performance in the 2.4 GHz, 5 GHz and 6 GHz bands supporting both WiFi 6 and WiFi 6E.

The ANT-W63-IPW1-NP provides a ground plane independent dipole antenna solution which mounts to metallic and non-metallic surfaces. The antenna housing is UV stabilized (ASA) and connects using an N plug (male pin) connector.



Features

- Performance at 5.15 GHz to 5.85 GHz
 - VSWR: ≤ 2.0
 - Peak Gain: 8.7 dBi
 - Efficiency: 82%
- Performance at 5.925 GHz to 7.125 GHz
 - VSWR: ≤ 2.3
 - Peak Gain: 5.5 dBi
 - Efficiency: 72%
- Enhanced heat and chemical resistant UV stabilized Luran® S 778T (ASA) antenna housing material
- IP67 rated
- N plug (male pin) connector

Applications

- WiFi/WLAN coverage
 - WiFi 6E (802.11ax)
 - WiFi 6 (802.11ax)
 - WiFi 5 (802.11ac)
 - WiFi 4 (802.11n)
 - 802.11b/g
- 2.4 GHz ISM applications
 - Bluetooth®
 - ZigBee®
- U-NII bands 1-8
- Internet of Things (IoT) devices
- Smart Home networking
- Sensing and remote monitoring

Ordering Information

Part Number	Description
ANT-W63-IPW1-NP	WiFi 6 outdoor whip antenna with N plug (male pin) connector

Available from Linx Technologies and select distributors and representatives.

Table 1. Electrical Specifications

ANT-W63-IPW1-NP	ISM/WiFi	WiFi/U-NII 1-4	WiFi 6E/U-NII 5-8
Frequency Range	2400 MHz to 2485 MHz	5150 MHz to 5850 MHz	5925 MHz to 7125 MHz
VSWR (max)	4.1	2.0	2.3
Peak Gain (dBi)	3.2	8.7	5.5
Average Gain (dBi)	-2.2	-1.1	-1.8
Efficiency (%)	64	82	72
Impedance	50 Ω		
Wavelength	1/2-wave		
Electrical Type	Dipole		
Polarization	Linear		
Radiation	Omnidirectional		
Max Power	2 W		

Electrical specifications and plots measured with the antenna in a free space orientation.

Table 2. Mechanical Specifications

Connection	N plug (male pin)
Connector Torque Recommended/Maximum	5 Nm/ 15 Nm
Operating Temperature Range	-40 °C to +70 °C
Ingress Protection Rating (IP)	IP67 rated
Antenna Color	White
Weight	76.1 g (2.68 oz)
Dimensions	178.0 mm x Ø25.0 mm (7.00 in x Ø0.98 in)

Product Dimensions

Figure 1 provides dimensions of the ANT-W63-IPW1-NP.

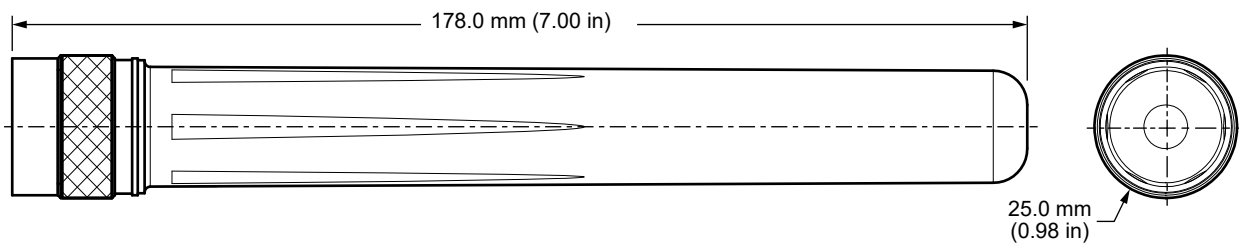

Figure 1. ANT-W63-IPW1-NP Antenna Dimensions

Packaging Information

The ANT-W63-IPW1-NP antenna is packaged in a clear plastic bag. Distribution channels may offer alternative packaging options.

IP (Ingress Protection) Rating

An ingress protection rating (IP rating) refers to the capability of a device to withstand the ingress of dust and/or water under specified conditions. IP rating is typically reserved for marketable product (device) rather than constituent components because design and assembly may affect performance of the device under testing. IP-rated antennas are designed to support the specified level of ingress protection and may be tested in a standalone configuration, however IP testing should be performed on the complete end product to ensure desired performance.

Antenna Orientation

The ANT-W63-IPW1-NP antenna is characterized in two antenna orientations as shown in Figure 2. The antenna in a free space orientation characterizes use of an antenna attached to an enclosure-mounted connector which is connected by cable to a printed circuit board. Although the antenna is a dipole not requiring a ground plane for function, characterization at the center of the ground plane (300 mm x 300 mm) provides insight into antenna performance when attached directly to a connector on a metal enclosure. The two orientations represent the most common end-product use cases.

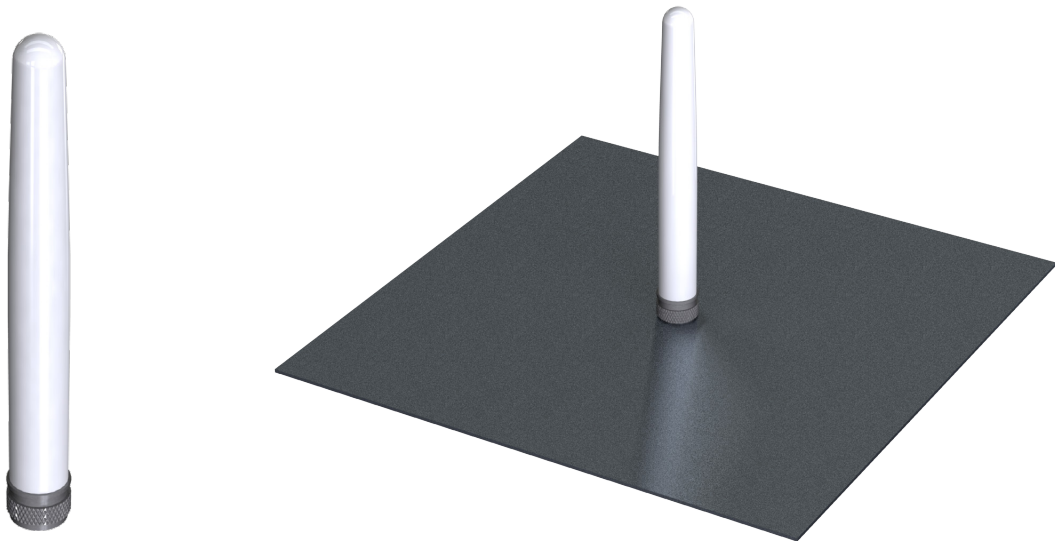

ANT-W63-IPW1-NP in Free Space

ANT-W63-IPW1-NP at Center of 300 mm x 300 mm Ground Plane

Figure 2. ANT-5GW-IPW1-NP Test Orientations

Free Space, No Ground Plane

The charts on the following pages represent data taken with the antenna oriented in free space as shown in Figure 3.



Figure 3. ANT-5GW-IPW1-NP No Ground Plane (Free Space)

VSWR

Figure 4 provides the voltage standing wave ratio (VSWR) across the antenna bandwidth. VSWR describes the power reflected from the antenna back to the radio. A lower VSWR value indicates better antenna performance at a given frequency. Reflected power is also shown on the right-side vertical axis as a gauge of the percentage of transmitter power reflected back from the antenna.

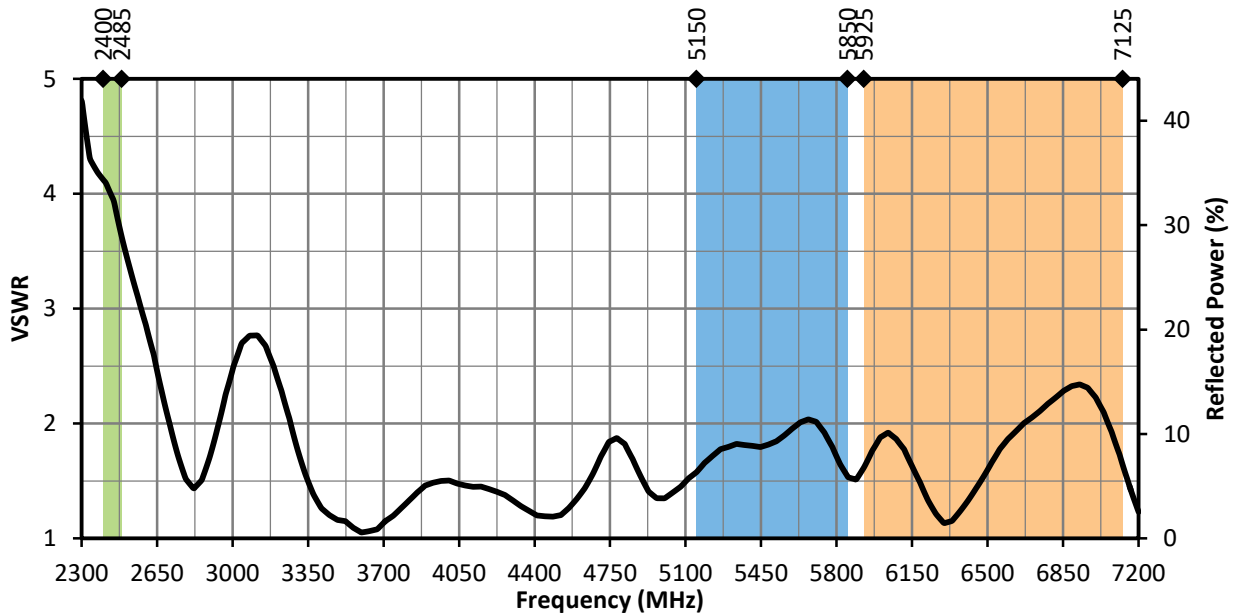

Figure 4. ANT-W63-IPW1-NP Antenna VSWR, Free Space

Return Loss

Return loss (Figure 5), represents the loss in power at the antenna due to reflected signals. Like VSWR, a lower return loss value indicates better antenna performance at a given frequency.

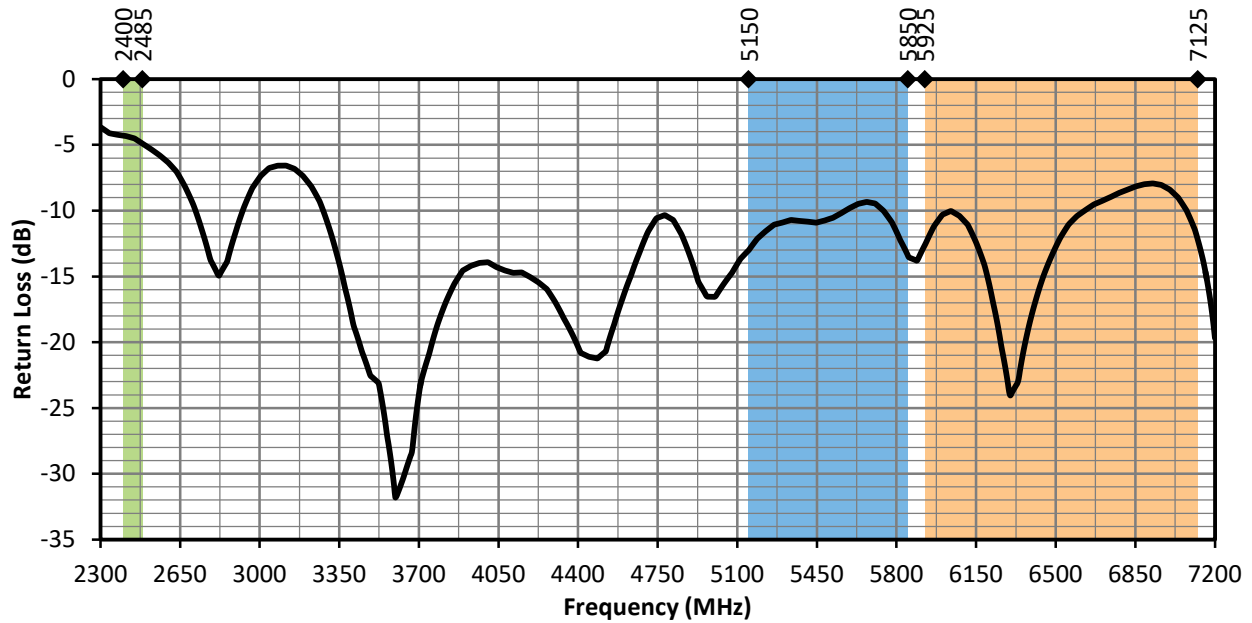

Figure 5. ANT-W63-IPW1-NP Antenna Return Loss, Free Space

Peak Gain

The peak gain across the antenna bandwidth is shown in Figure 6. Peak gain represents the maximum antenna input power concentration across 3-dimensional space, and therefore peak performance, at a given frequency, but does not consider any directionality in the gain pattern.

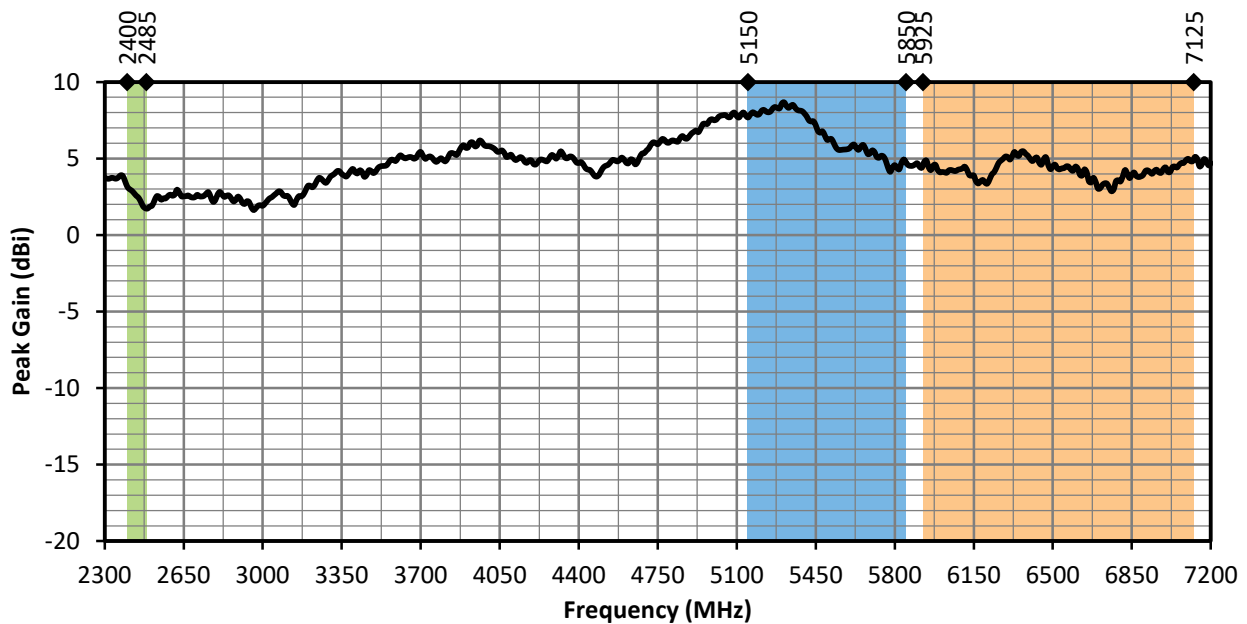

Figure 6. ANT-W63-IPW1-NP Antenna Peak Gain, Free Space

Average Gain

Average gain (Figure 7), is the average of all antenna gain in 3-dimensional space at each frequency, providing an indication of overall performance without expressing antenna directionality.

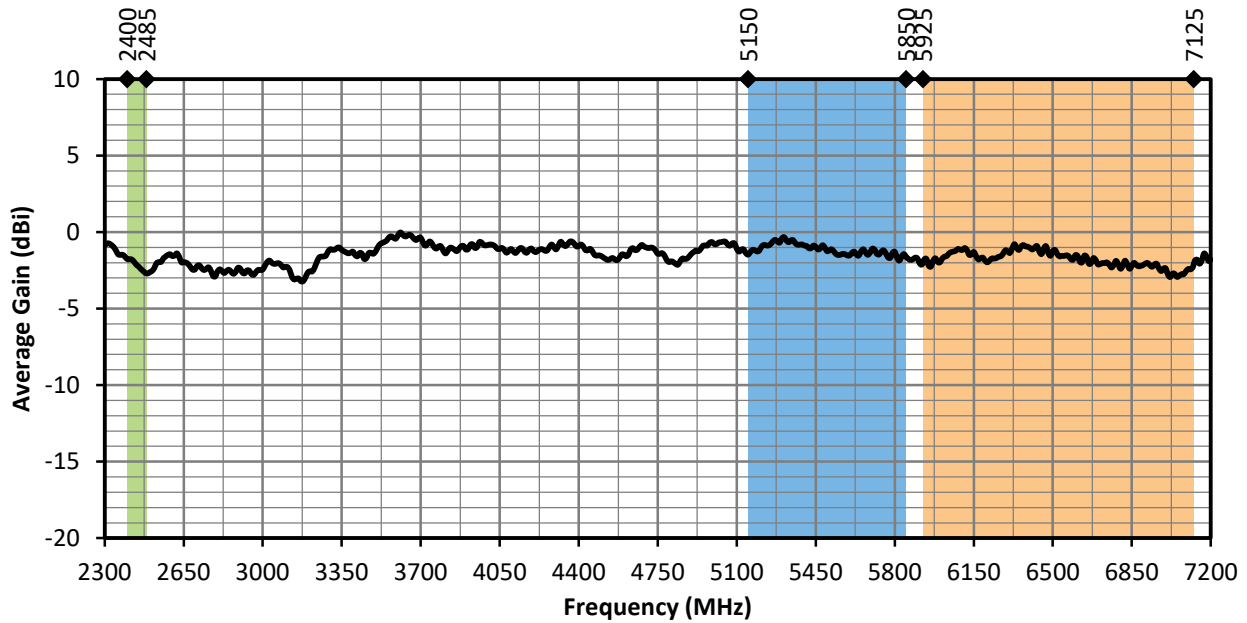

Figure 7. ANT-W63-IPW1-NP Antenna Average Gain, Free Space

Radiation Efficiency

Radiation efficiency (Figure 8), shows the ratio of power delivered to the antenna relative to the power radiated at the antenna, expressed as a percentage, where a higher percentage indicates better performance at a given frequency.

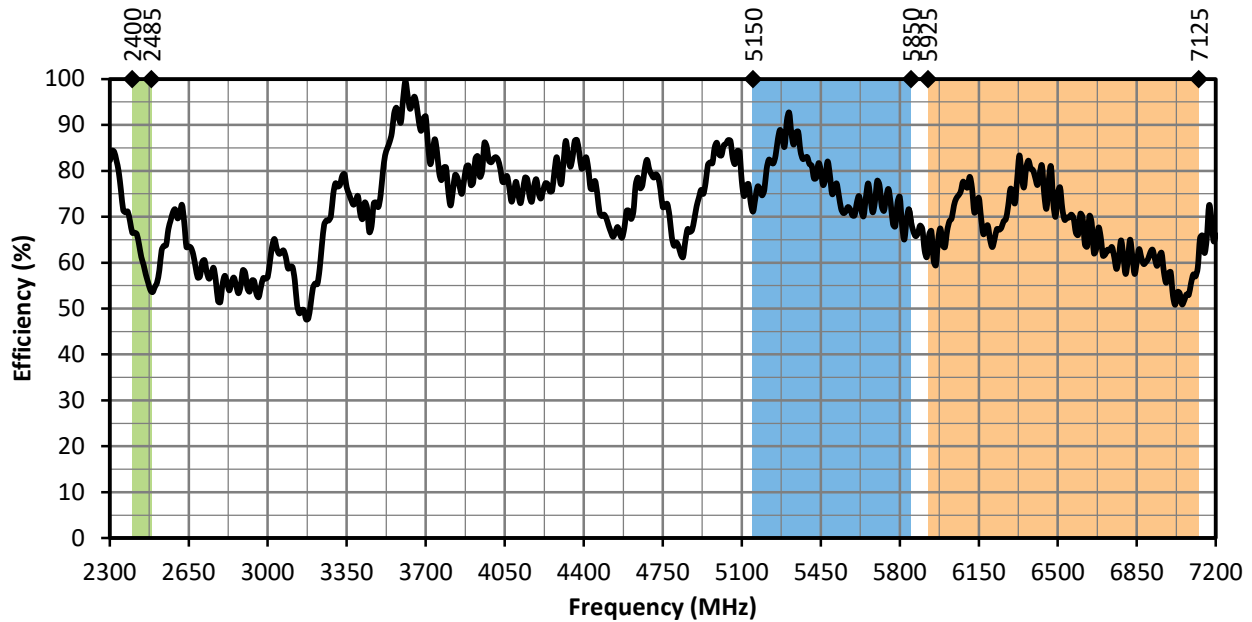

Figure 8. ANT-W63-IPW1-NP Antenna Radiation Efficiency, Free Space

Radiation Patterns

Radiation patterns provide information about the directionality and 3-dimensional gain performance of the antenna by plotting gain at specific frequencies in three orthogonal planes. Antenna radiation patterns for a free space orientation are shown in Figure 9 using polar plots covering 360 degrees. The antenna graphic at the top of the page provides reference to the plane of the column of plots below it. Note: when viewed with typical PDF viewing software, zooming into radiation patterns is possible to reveal fine detail.

Radiation Patterns - Free Space



XZ-Plane Gain

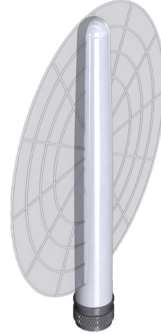

YZ-Plane Gain

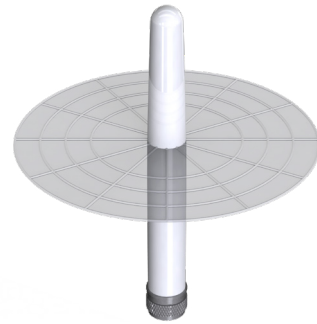

XY-Plane Gain

2400 MHz to 2485 MHz (2450 MHz)

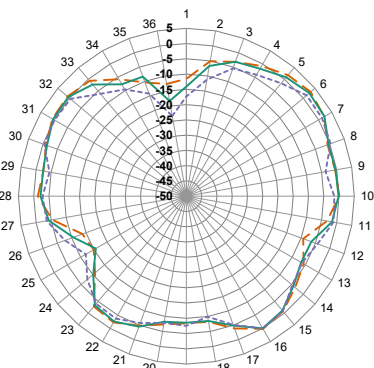

XZ-Plane Gain

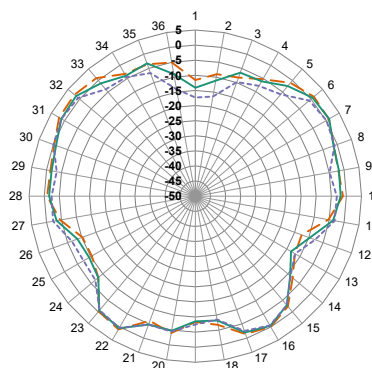

YZ-Plane Gain

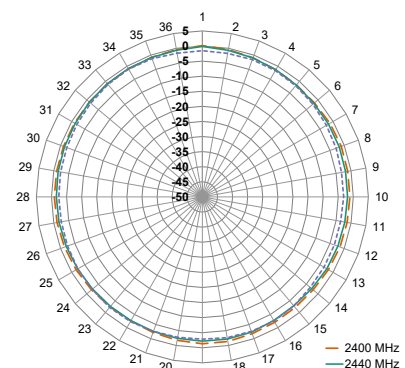

XY-Plane Gain

— 2400 MHz
— 2440 MHz
- - 2490 MHz

5150 MHz to 5850 MHz (5500 MHz)

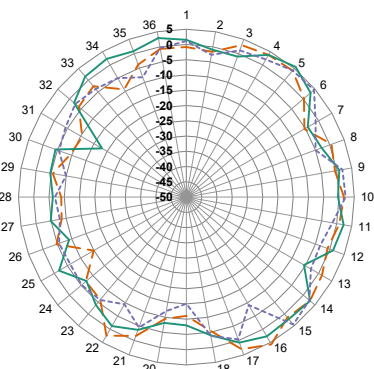

XZ-Plane Gain

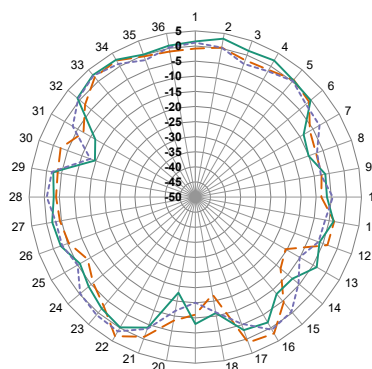

YZ-Plane Gain

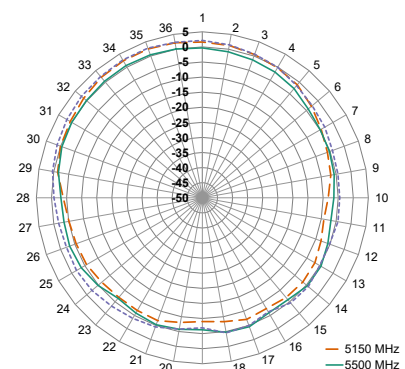

XY-Plane Gain

— 5150 MHz
— 5500 MHz
- - 5850 MHz

Radiation Patterns - Free Space

5925 MHz to 7125 MHz (6500 MHz)

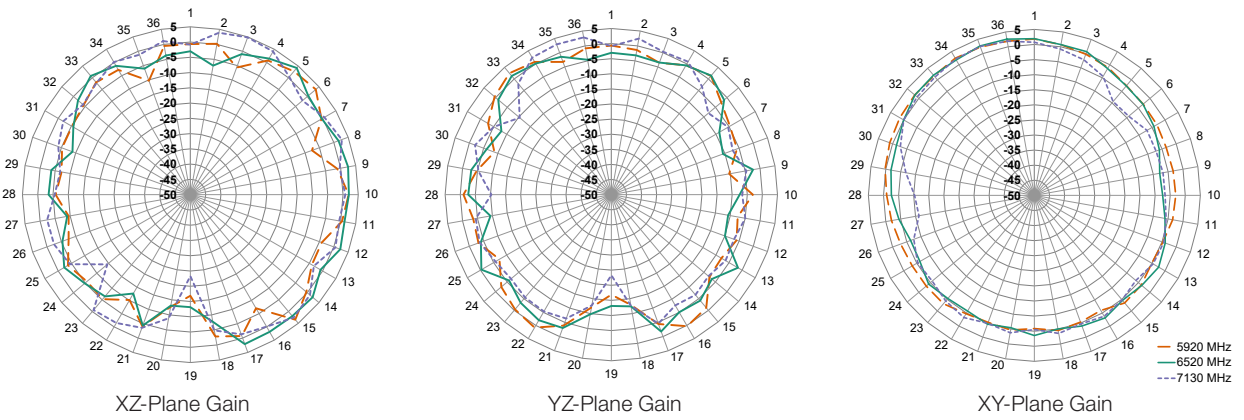

Figure 9. Radiation Patterns for ANT-W63-IPW1-NP Antenna, in Free Space

Center of Ground Plane

The charts on the following pages represent data taken with the antenna oriented at the center of the ground plane as shown in Figure 10.

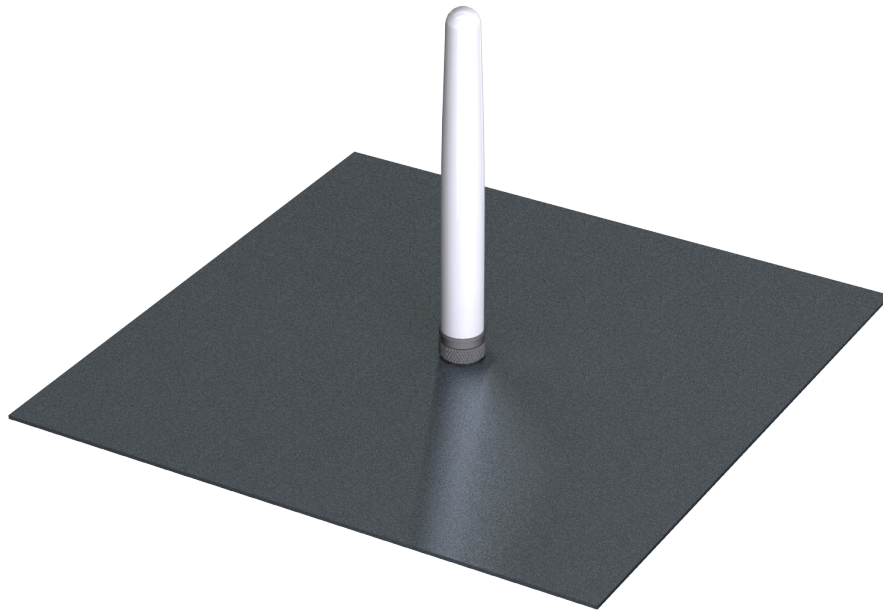

Figure 10. ANT-5GW-IPW1-NP, at Center of Ground Plane

VSWR

Figure 11 provides the voltage standing wave ratio (VSWR) across the antenna bandwidth. VSWR describes the power reflected from the antenna back to the radio. A lower VSWR value indicates better antenna performance at a given frequency. Reflected power is also shown on the right-side vertical axis as a gauge of the percentage of transmitter power reflected back from the antenna.

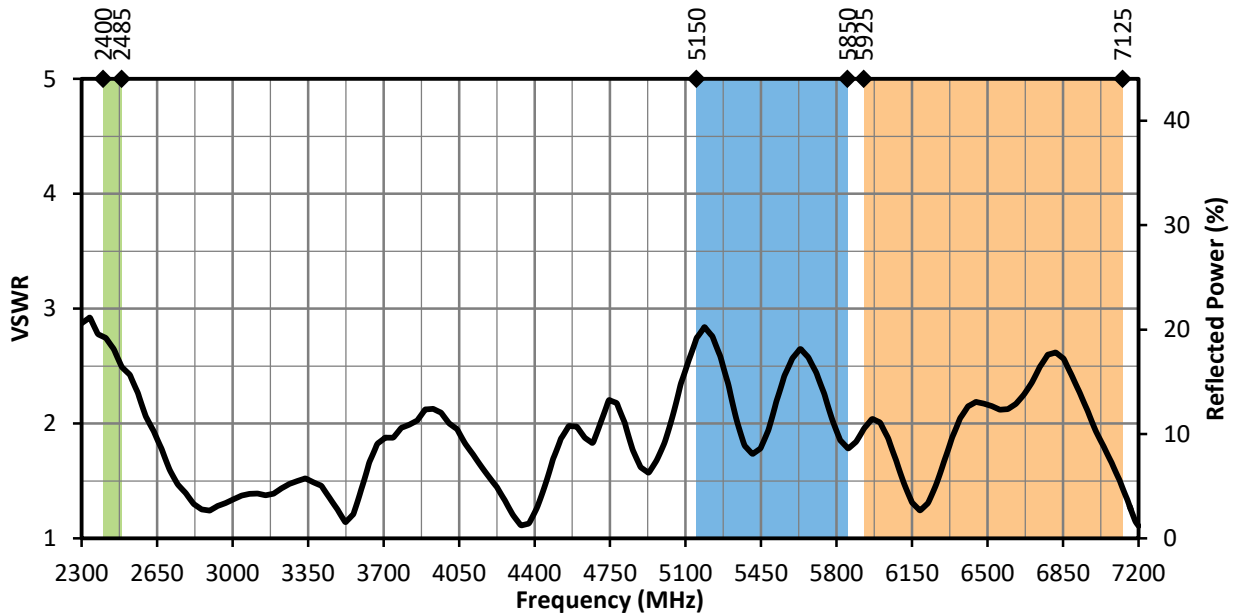

Figure 11. ANT-W63-IPW1-NP Antenna VSWR, at Center of Ground Plane

Return Loss

Return loss (Figure 12), represents the loss in power at the antenna due to reflected signals. Like VSWR, a lower return loss value indicates better antenna performance at a given frequency.

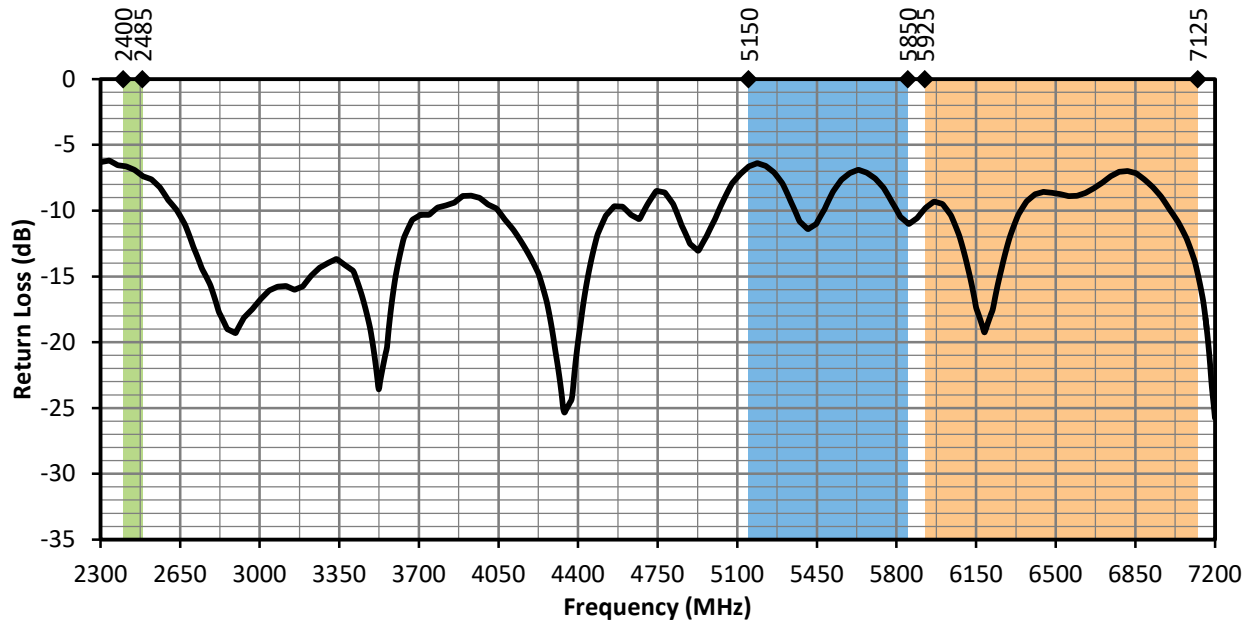

Figure 12. ANT-W63-IPW1-NP Antenna Return Loss, at Center of Ground Plane

Peak Gain

The peak gain across the antenna bandwidth is shown in Figure 13. Peak gain represents the maximum antenna input power concentration across 3-dimensional space, and therefore peak performance, at a given frequency, but does not consider any directionality in the gain pattern.

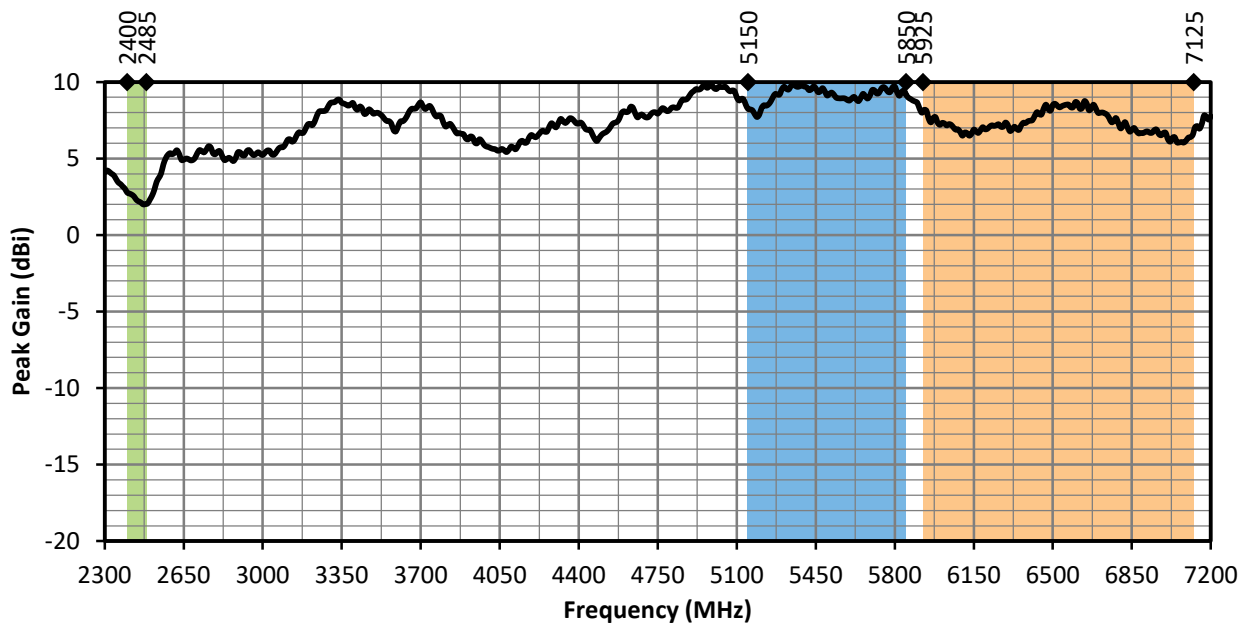

Figure 13. ANT-W63-IPW1-NP Antenna Peak Gain, at Center of Ground Plane

Average Gain

Average gain (Figure 14), is the average of all antenna gain in 3-dimensional space at each frequency, providing an indication of overall performance without expressing antenna directionality.

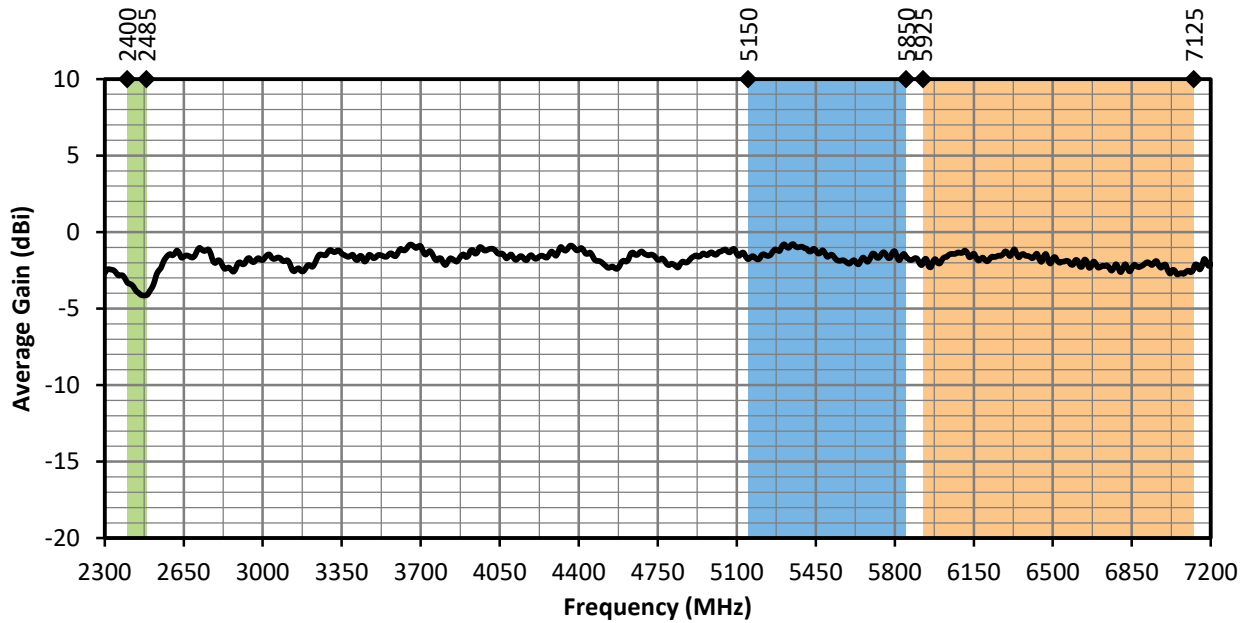

Figure 14. ANT-W63-IPW1-NP Antenna Average Gain, at Center of Ground Plane

Radiation Efficiency

Radiation efficiency (Figure 15), shows the ratio of power delivered to the antenna relative to the power radiated at the antenna, expressed as a percentage, where a higher percentage indicates better performance at a given frequency.

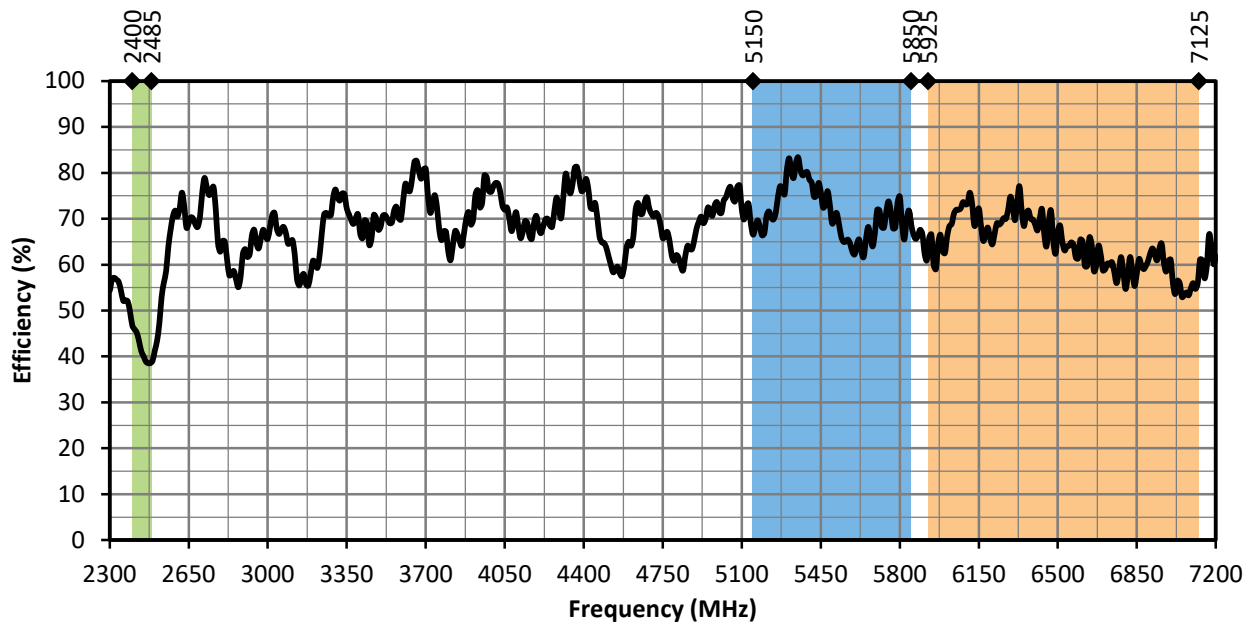
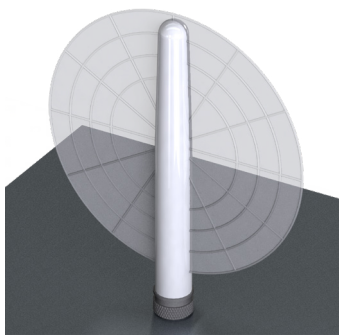

Figure 15. ANT-W63-IPW1-NP Antenna Radiation Efficiency, at Center of Ground Plane

Radiation Patterns

Radiation patterns provide information about the directionality and 3-dimensional gain performance of the antenna by plotting gain at specific frequencies in three orthogonal planes. Antenna radiation patterns for an orientation at the center of the ground plane are shown in Figure 16 using polar plots covering 360 degrees. The antenna graphic at the top of the page provides reference to the plane of the column of plots below it. Note: when viewed with typical PDF viewing software, zooming into radiation patterns is possible to reveal fine detail.

Radiation Patterns - Center of Ground Plane



XZ-Plane Gain

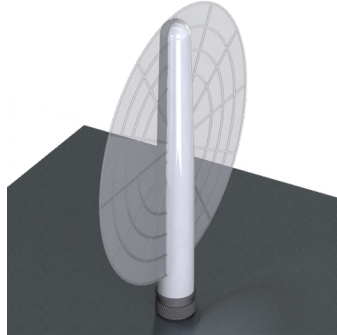

YZ-Plane Gain

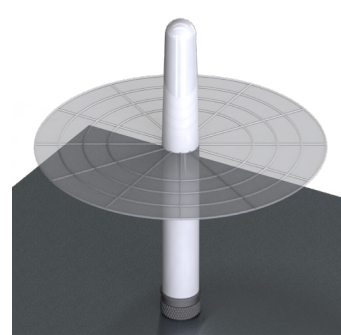

XY-Plane Gain

2400 MHz to 2485 MHz (2450 MHz)

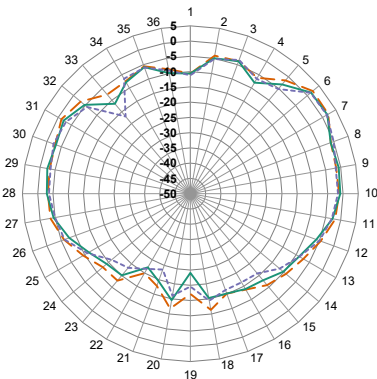

XZ-Plane Gain

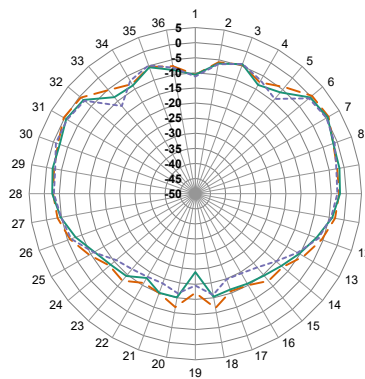

YZ-Plane Gain

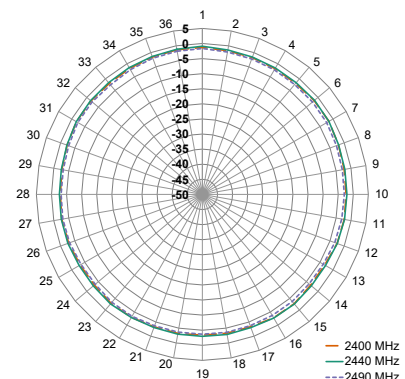

XY-Plane Gain

5150 MHz to 5850 MHz (5500 MHz)

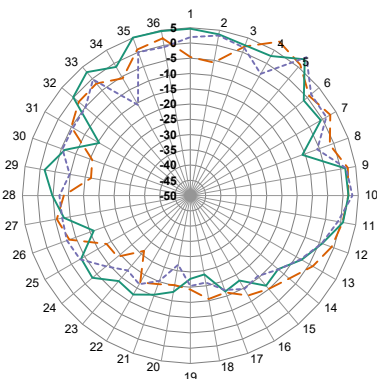

XZ-Plane Gain

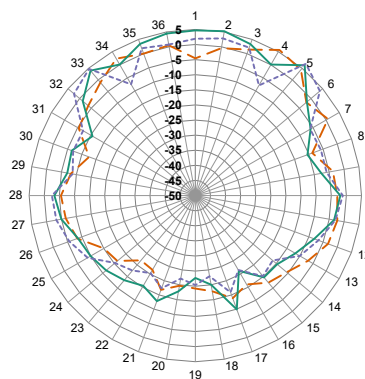

YZ-Plane Gain

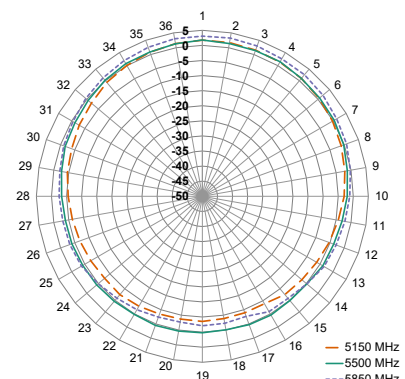

XY-Plane Gain

Radiation Patterns - Center of Ground Plane
5925 MHz to 7125 MHz (6500 MHz)

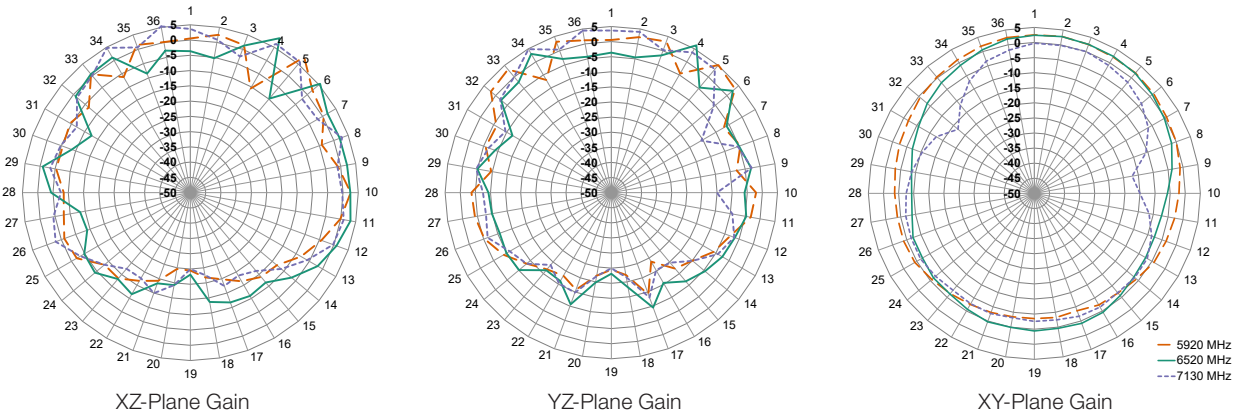

Figure 16. Radiation Patterns for ANT-W63-IPW1-NP Antenna, at Center of Ground Plane

Website: <http://linxtechnologies.com>
Linx Offices: 159 Ort Lane, Merlin, OR, US 97532
Phone: +1 (541) 471-6256
E-MAIL: info@linxtechnologies.com

Linx Technologies reserves the right to make changes to the product(s) or information contained herein without notice. No liability is assumed as a result of their use or application. No rights under any patent accompany the sale of any such product(s) or information.

Wireless Made Simple is a registered trademark of Linx Acquisitions LLC. Bluetooth is a registered trademark of Bluetooth SIG, Inc. ZigBee is a registered trademark of ZigBee Alliance, Inc. Other product and brand names may be trademarks or registered trademarks of their respective owners.

Copyright © 2021 Linx Technologies

All Rights Reserved

Doc# DS21355-182ANT Replaces (DS21273-182ANT)

