

ISL85014

14A, 3.8V to 18V Input, Synchronous Buck Regulator

FN8925
Rev.3.00
Nov 11, 2021

The **ISL85014** is a highly efficient, monolithic, synchronous buck regulator that can deliver 14A of continuous output current from a 3.8V to 18V input supply. The device uses current mode control architecture with a fast transient response and excellent loop stability.

The ISL85014 integrates very low ON-resistance high-side and low-side FETs to maximize efficiency and minimize external component count. The minimum BOM and easy layout footprint are extremely friendly to space constraint systems.

The operation frequency of this device can be set using the FREQ pin: 600kHz (FREQ = float) and 300kHz (FREQ = GND). The device can also be synchronized to an external clock up to 1MHz.

Both high-side and low-side MOSFET current limit, along with reverse current limit, fully protects the regulator in an overcurrent event. Selectable OCP schemes can fit various applications. Other protections, such as input/output overvoltage and over-temperature, are also integrated into the device and provide required system level safety in the event of fault conditions.

The ISL85014 is offered in a space saving 15 Ld 3.5mmx3.5mm Pb-free TQFN package with great thermal performance and 0.8mm maximum height.

Features

- Power input voltage range variable 3.8V to 18V
- PWM output voltage adjustable from 0.6V
- Up to 14A output load
- Prebias start-up, fixed 3ms soft-start
- Selectable f_{SW} of 300kHz, 600kHz, and external synchronization up to 1MHz
- Peak current mode control
 - DCM/CCM
 - Thermally compensated current limit
 - Internal/external compensation
- Open-drain PG window comparator
- Output overvoltage and thermal protection
- Input overvoltage protection
- Integrated boot diode with undervoltage detection
- Selectable OCP schemes
 - Hiccup OCP
 - Latch-off
- Compact size 3.5mmx3.5mm, 15 Ld TQFN

Applications

- Servers and cloud infrastructure POLs
- IPCs, factory automation, PLCs
- Telecom and networking systems
- Storage systems
- Test measurement

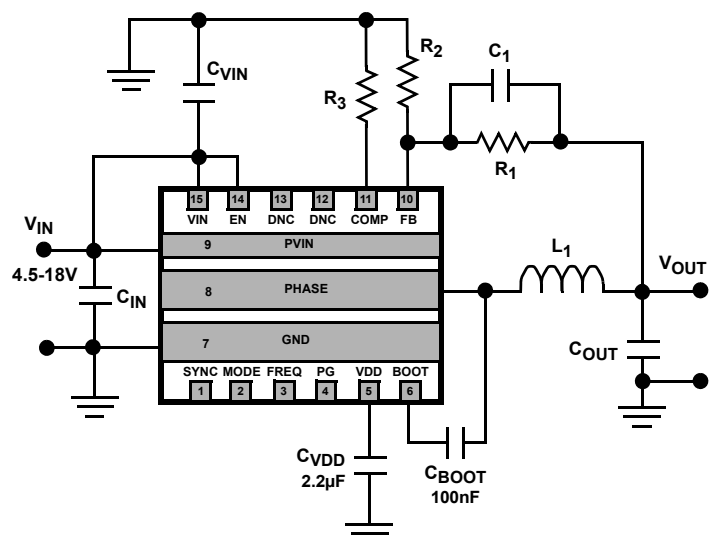

FIGURE 1. TYPICAL APPLICATION SCHEMATIC FOR INTERNAL COMPENSATION

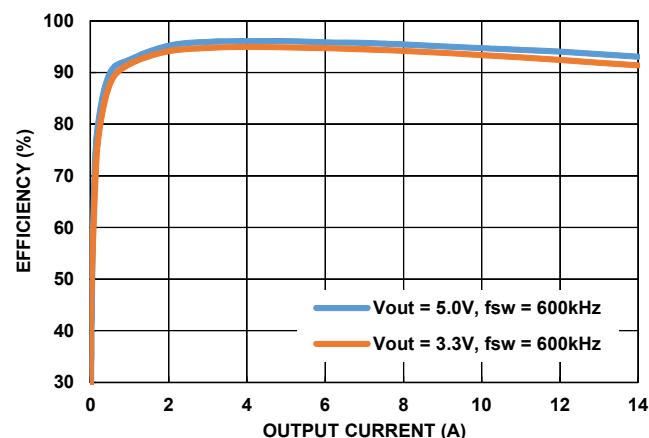

FIGURE 2. EFFICIENCY ($V_{IN} = 12V$)

Typical Application Schematic

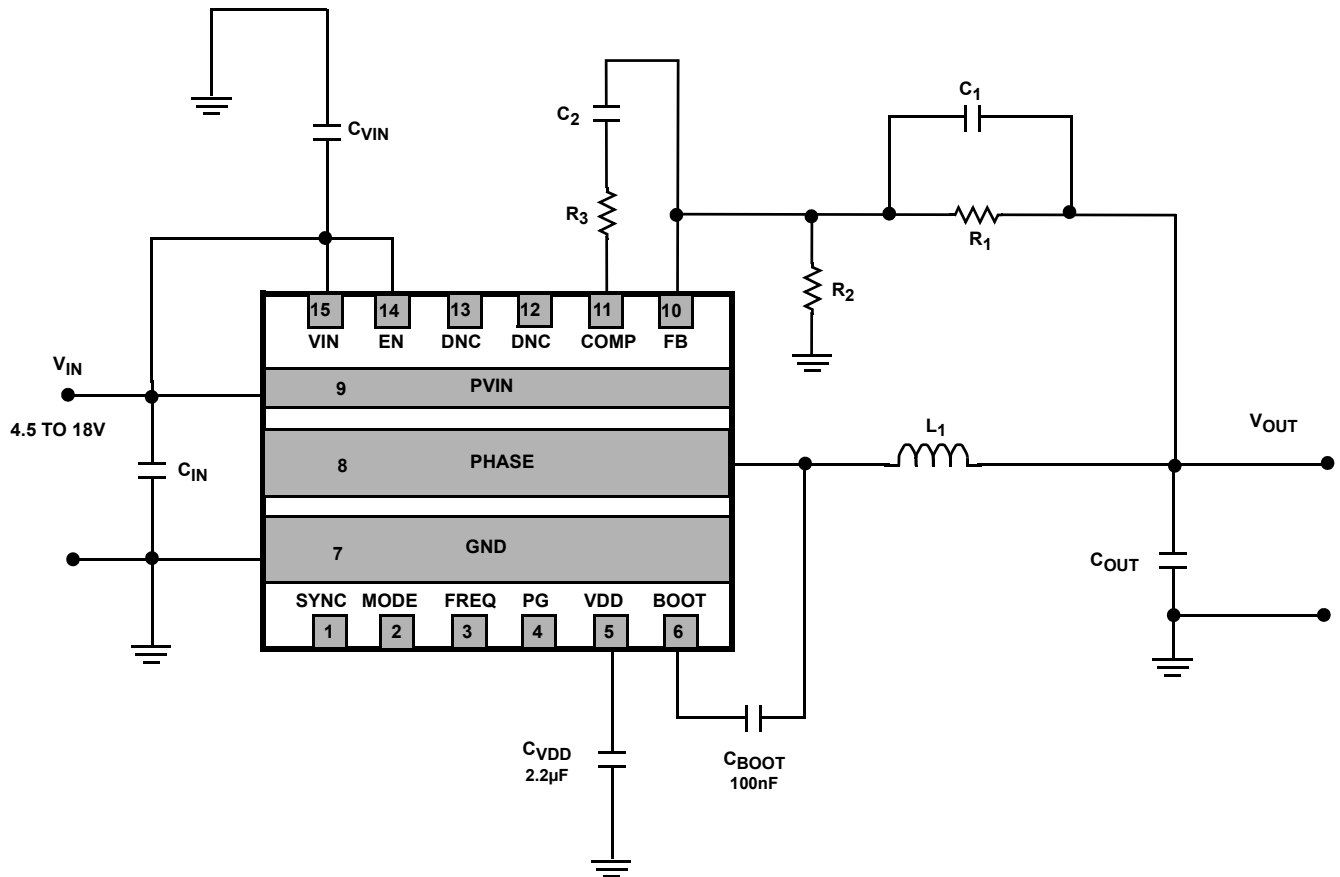

FIGURE 3. TYPICAL APPLICATION SCHEMATIC FOR EXTERNAL COMPENSATION

TABLE 1. DESIGN TABLE FOR DIFFERENT OUTPUT VOLTAGE USING INTERNAL COMPENSATION (SEE [Figure 1](#))

V _{OUT} (V)	1	1.2	1.8	3.3	5
V _{IN} (V)	4.5 to 18	4.5 to 18	4.5 to 18	4.5 to 18	6.5 to 18
FREQ (kHz)	300	300	600	600	600
Compensation	Internal	Internal	Internal	Internal	Internal
C _{IN} (µF)	3x22	3x22	3x22	3x22	3x22
C _{OUT} (µF)	1000 + 4x100	1000 + 3x100	4x100	4x100	4x100
L ₁ (µH)	0.68	1	0.68	1	1.5
R ₁ (kΩ)	200	300	200	365	365
R ₂ (kΩ)	300	300	100	80.6	49.9
C ₁ (pF)	DNP	DNP	DNP	4.7	8.2

NOTES:

1. The design table is referencing the schematic shown in [Figure 1](#).
2. Ceramic capacitors are selected for 22µF and 100µF in the table.
3. 1000µF (5mΩ) are selected for low ESR conductive polymer aluminum solid capacitors.
4. Recommend to keep the inductor peak-to-peak current less than 6A.

Ordering Information

PART NUMBER (Notes 6, 7)	PART MARKING	TEMP. RANGE	CARRIER TYPE (Note 5)	PACKAGE DESCRIPTIONS (RoHS COMPLIANT)	PKG. DWG. #
ISL85014FRZ-T	5014	-40 to +125 °C	Reel, 6k	15 Ld 3.5mmx3.5mm TQFN	L15.3.5x3.5
ISL85014FRZ-T7A			Reel, 250		
ISL85014EVAL1Z	Evaluation Board				

NOTES:

5. See [TB347](#) for details on reel specifications.
6. These Pb-free plastic packaged products employ special Pb-free material sets, molding compounds/die attach materials, and 100% matte tin plate plus anneal (e3 termination finish, which is RoHS compliant and compatible with both SnPb and Pb-free soldering operations). Pb-free products are MSL classified at Pb-free peak reflow temperatures that meet or exceed the Pb-free requirements of IPC/JEDEC J-STD-020.
7. For Moisture Sensitivity Level (MSL), see product information page for [ISL85014](#). For more information on MSL, see [TB363](#).

TABLE 2. KEY DIFFERENCES BETWEEN FAMILY OF PARTS

PART NUMBER	INTERNAL/EXTERNAL COMPENSATION	EXTERNAL FREQUENCY SYNC	CURRENT RATING
ISL85009	Yes	Yes	9A
ISL85012	Yes	Yes	12A
ISL85014	Yes	Yes	14A

Functional Block Diagram

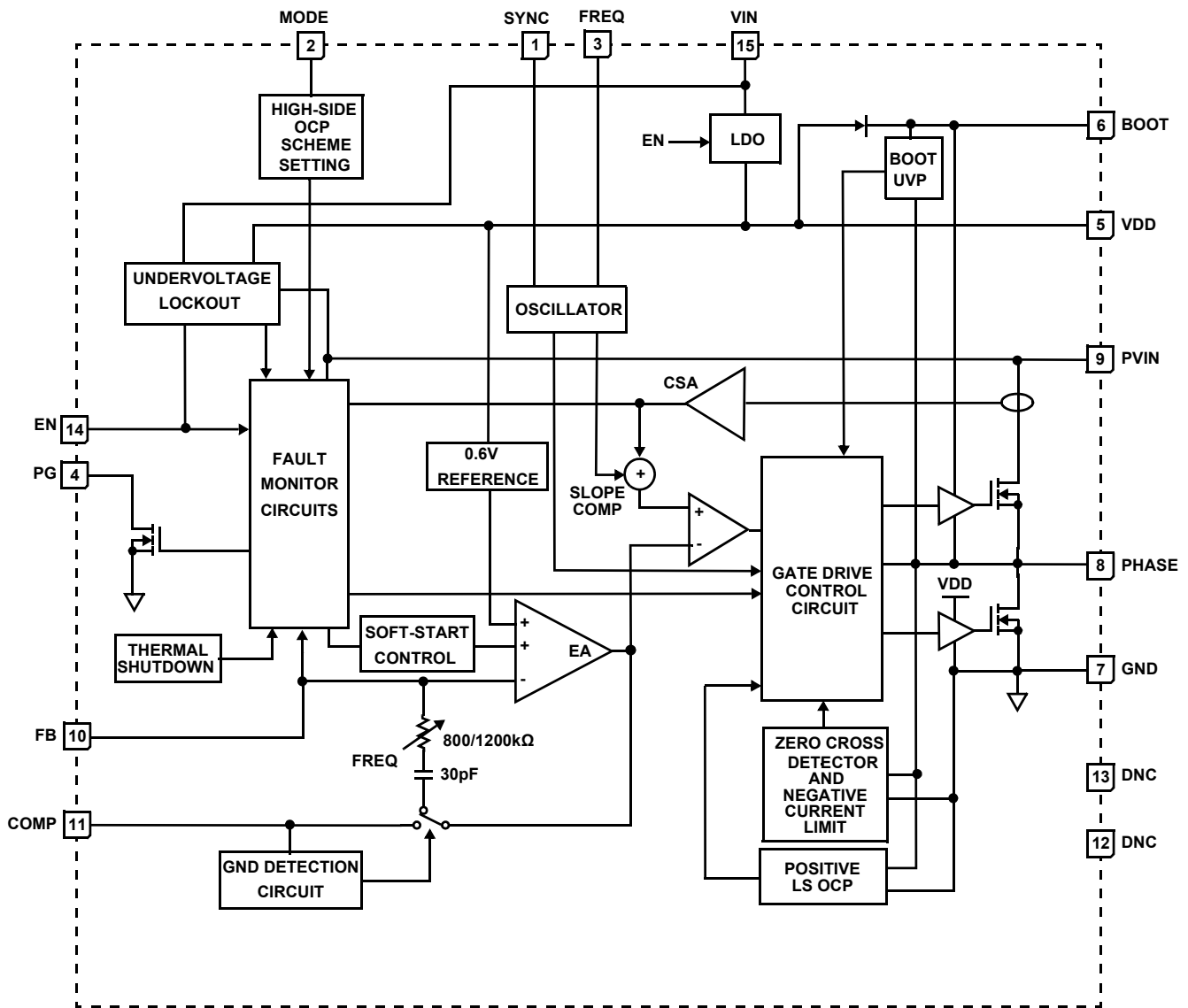
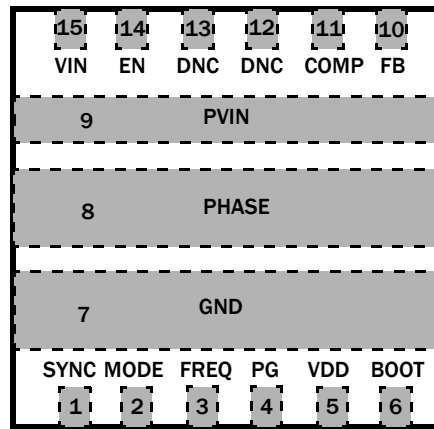

FIGURE 4. FUNCTIONAL BLOCK DIAGRAM

Pin Configuration

ISL85014
(15 LD 3.5mmx3.5mm TQFN)
TOP VIEW



Pin Descriptions

PIN NUMBER	PIN NAME	DESCRIPTION
1	SYNC	Synchronization and FCCM/DEM selection pin. Connect to VDD or float for Forced Continuous Conduction mode. Connect to GND for Diode Emulation mode in the light-load condition. Connect to an external clock signal for synchronization with the rising edge trigger.
2	MODE	OCP scheme select pin. Short it to GND for Latch-Off mode. Float it for Hiccup mode.
3	FREQ	Default frequency selection pin. Short it to GND for 300kHz. Float it for 600kHz.
4	PG	Power-good, open-drain output. It requires a pull-up resistor (10kΩ to 100kΩ) between PG and VDD or a voltage not exceeding 5.5V. PG pulls high when FB is in the range of ~90% to ~116% of its intended value.
5	VDD	Low dropout linear regulator decoupling pin. The VDD is the internally generated 5V supply voltage and is derived from VIN. The VDD is used to power all the internal core analog control blocks and drivers. Connect a 2.2μF capacitor from VDD to the board ground plane. If the VIN is between 3V to 5.5V, then connect VDD directly to VIN to improve efficiency.
6	BOOT	BOOT is the floating bootstrap supply pin for the high-side power MOSFET gate driver. A bootstrap capacitor, usually 0.1μF, is required between BOOT and PHASE.
7	GND	Reference of the power circuit. For thermal relief, this pin should be connected to the ground plane by vias.
8	PHASE	Switch node connection to the internal power MOSFETs (source of upper FET and drain of lower FET) and the external output inductor.
9	PVIN	Input supply for the PWM regulator power stage. A decoupling capacitor, typically ceramic, is required to be connected between this pin and GND.
10	FB	Inverting input to the voltage loop error amplifier. The output voltage is set by an external resistor divider connected to FB.
11	COMP	Output of the error amplifier. Compensation network between COMP and FB to configure external compensation. Place a 200Ω resistor between COMP and GND for internal compensation, which is used to meet most applications.
12, 13	DNC	Do Not Connect to pin. Float the pins in the design.
14	EN	Enable input. The regulator is held off when this pin is pulled to ground. The device is enabled when the voltage on this pin rises to about 0.6V.
15	VIN	Input supply for the control circuit and the source for the internal linear regulator that provides bias for the IC. A decoupling capacitor, typically 1μF ceramic, is required between VIN and GND.

Absolute Maximum Ratings

VIN, EN to GND	-0.3V to +22V
PVIN to GND	-0.3V to +22V
PHASE to GND	-0.7V to +22V (DC)
PHASE to GND	-2V to +22V (40ns)
BOOT to PHASE	-0.3V to +7V
VDD, COMP, SYNC, PG, FB, MODE, FREQ, SS, IOCP to GND	-0.3V to +7V
ESD Rating	
Human Body Model (Tested per JS-001-2014)	2.5kV
Charged Device Model (Tested per JS-002-2014)	1kV
Latch-Up (Tested per JESD78E; Class 2, Level A, +125°C)	100mA

Thermal Information

Thermal Resistance	θ_{JA} (°C/W)	θ_{JC} (°C/W)
TQFN Package (Notes 8, 9)	33	1.2
Maximum Storage Temperature Range	-65°C to +150°C	
Junction Temperature Range	-55°C to +150°C	
Pb-Free Reflow Profile	see TB493	

Recommended Operating Conditions

VIN Supply Voltage Range	4.5V to 18V
PVIN Supply Voltage Range	3.8V to 18V
Load Current Range	0A to 14A

CAUTION: Do not operate at or near the maximum ratings listed for extended periods of time. Exposure to such conditions can adversely impact product reliability and result in failures not covered by warranty.

NOTES:

- θ_{JA} is measured in free air with the component mounted on a high-effective thermal conductivity test board with direct attach features, except with three vias under the GND EPAD strip contacting the GND plane and two vias under the VIN EPAD strip contacting the VIN plane. See [TB379](#).
- For θ_{JC} , the case temperature location is the center of the exposed metal pad on the package underside.

Electrical Specifications All parameter limits are established across the recommended operating conditions and the typical specification are measured at the following conditions: $T_J = -40^\circ\text{C}$ to $+125^\circ\text{C}$, $V_{IN} = 4.5\text{V}$ to 18V , unless otherwise noted. Typical values are at $T_A = +25^\circ\text{C}$. **Boldface limits apply across the operating temperature range, -40°C to $+125^\circ\text{C}$.**

PARAMETER	SYMBOL	TEST CONDITIONS	MIN (Note 10)	TYP	MAX (Note 10)	UNIT
SUPPLY VOLTAGE						
PVIN Voltage Range	PVIN		3.8		18	V
VIN Voltage Range	VIN		4.5		18	V
VIN Quiescent Supply Current	I _Q	EN = 2V, FB = 0.64V		3	5	mA
VIN Shutdown Supply Current	I _{SD}	EN = GND		8	13	μA
POWER-ON RESET						
PVIN POR Threshold		Rising edge			2.9	V
		Falling edge	1.9			V
VIN POR Threshold		Rising edge			4.49	V
		Falling edge	3.4			V
EN POR Threshold		Rising edge	0.5	0.6	0.7	V
		Hysteresis		100		mV
VDD POR Threshold		Rising edge			3.6	V
		Falling edge	2.4			V
INTERNAL VDD LDO						
VDD Output Voltage Regulation Range		V _{IN} = 6V to 18V, I _{VDD} = 0mA to 30mA	4.3	5.0	5.5	V
VDD Output Current Limit				80		mA
LDO Dropout Voltage		V _{IN} = 5V, I _{VDD} = 30mA			0.65	V
OSCILLATOR						
Nominal Switching Frequency	f _{SW1}	FREQ = float	540	600	660	kHz
Nominal Switching Frequency	f _{SW2}	FREQ = GND	250	280	310	kHz
Minimum On-Time	t _{ON}	I _{OUT} = 0mA		90	150	ns
Minimum Off-Time	t _{OFF}			140	170	ns
Synchronization Range			100		1000	kHz
SYNC Logic Input Low					0.5	V
SYNC Logic Input High			1.2			V

Electrical Specifications All parameter limits are established across the recommended operating conditions and the typical specification are measured at the following conditions: $T_J = -40^\circ\text{C}$ to $+125^\circ\text{C}$, $V_{IN} = 4.5\text{V}$ to 18V , unless otherwise noted. Typical values are at $T_A = +25^\circ\text{C}$. **Boldface limits apply across the operating temperature range, -40°C to $+125^\circ\text{C}$. (Continued)**

PARAMETER	SYMBOL	TEST CONDITIONS	MIN (Note 10)	TYP	MAX (Note 10)	UNIT
ERROR AMPLIFIER						
FB Regulation Voltage	V_{FB}		0.5895	0.600	0.6105	V
FB Leakage Current		$V_{FB} = 0.6\text{V}$			10	nA
Open-Loop Bandwidth	BW			5.5		MHz
Gain				70		dB
Output Drive		High-side clamp = 1.5V, low-side clamp = 0.4V		± 100		μA
Current Sense Gain	RT		0.050	0.055	0.063	Ω
Slope Compensation	Se	Tested at 600kHz		470		mV/ μs
SOFT-START						
Default Soft-Start Time			1.9	3.0	4.7	ms
PG						
Output Low Voltage		$I_{PG} = 5\text{mA}$		0.3		V
PG Pin Leakage Current				0.01		μA
PG Lower Threshold		Percentage of output regulation	81	87	92	%
PG Upper Threshold		Percentage of output regulation	110	116	121	%
PG Thresholds Hysteresis		SYNC is short-to-GND		3		%
Delay Time		Rising edge		1.5		ms
		Falling edge		23		μs
FAULT PROTECTION						
$V_{IN}/PVIN$ Overvoltage Lockout		Rising edge	19.0	20.5	22.0	V
		Falling edge	18.0	19.5	21.0	V
		Hysteresis		1		V
Positive Overcurrent Protection Threshold	I_{POCP}	High-side OCP	17.5	20	21.5	A
		Low-side OCP		23		A
Negative Overcurrent Protection Threshold	I_{NOCP}	Current forced into PHASE node, high-side MOSFET is off	-10.8	-7.5	-5.5	A
Hiccup Blanking Time				150		ms
FB Overvoltage Threshold			110	116	121	%
Thermal Shutdown Temperature	T_{SD}	Rising threshold		160		$^\circ\text{C}$
	T_{HYS}	Hysteresis		10		$^\circ\text{C}$
POWER MOSFET						
High-Side	R_{HDS}	$I_{PHASE} = 900\text{mA}$		15		m Ω
Low-Side	R_{LDS}	$I_{PHASE} = 900\text{mA}$		6.5		m Ω
PHASE Pull-Down Resistor		EN = GND		22.5		k Ω

NOTE:

10. Compliance to datasheet limits is assured by one or more methods: production test, characterization, and/or design.

Typical Characteristics

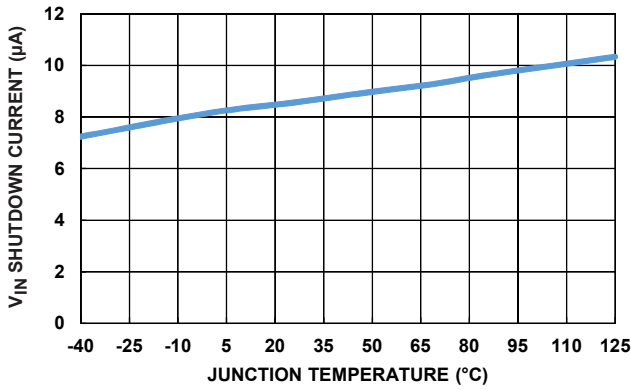

FIGURE 5. VIN SHUTDOWN CURRENT vs TEMPERATURE

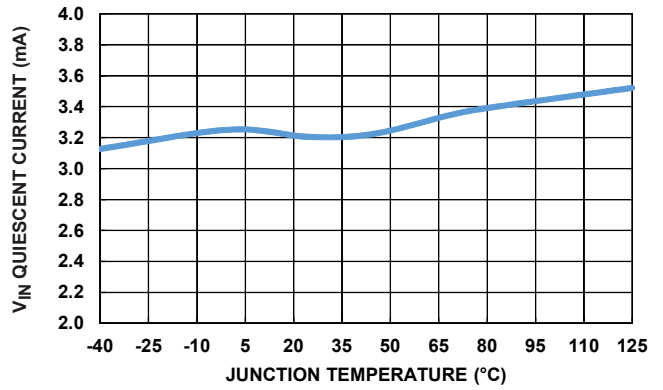

FIGURE 6. VIN QUIESCENT CURRENT vs TEMPERATURE

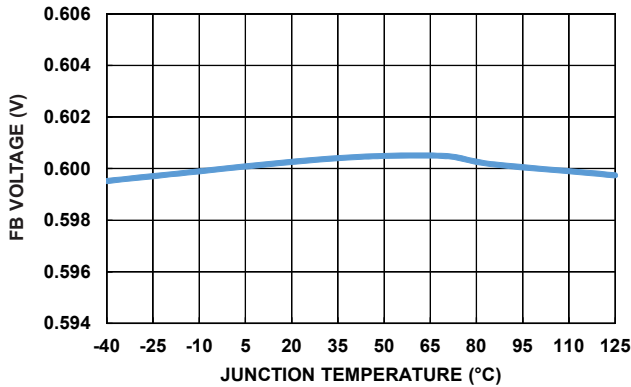

FIGURE 7. FEEDBACK VOLTAGE vs TEMPERATURE

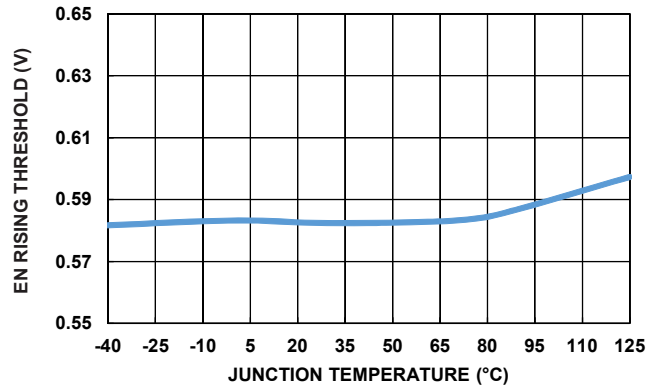

FIGURE 8. ENABLE THRESHOLD vs TEMPERATURE

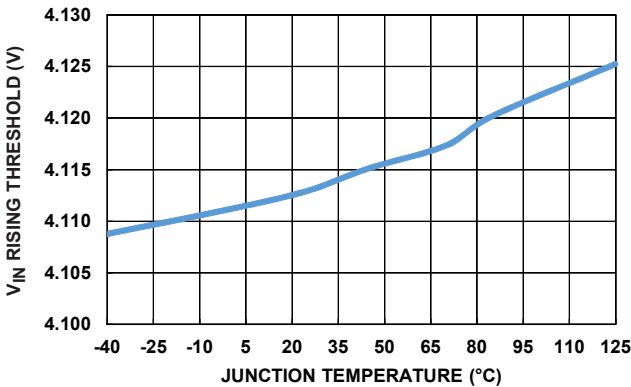

FIGURE 9. VIN POR (RISING) vs TEMPERATURE

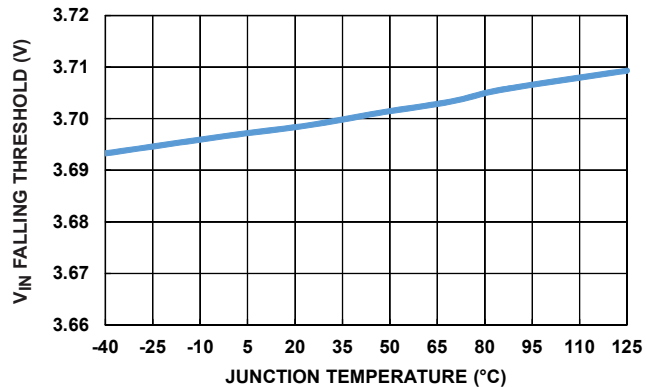

FIGURE 10. VIN POR (FALLING) vs TEMPERATURE

Typical Characteristics (Continued)

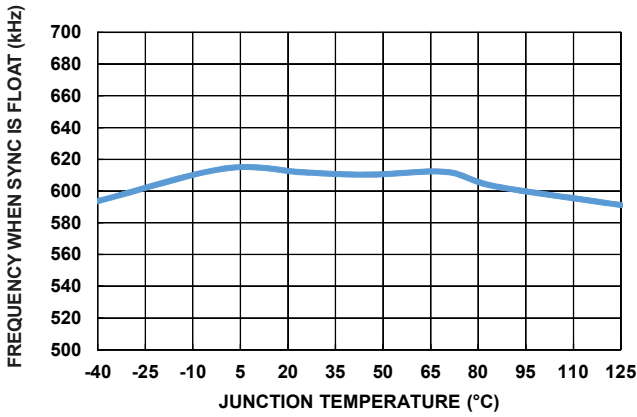

FIGURE 11. FREQUENCY (600kHz DEFAULT) vs TEMPERATURE

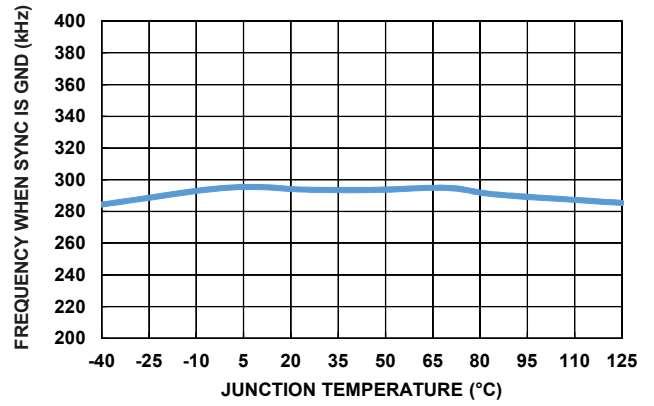

FIGURE 12. FREQUENCY (300kHz DEFAULT) vs TEMPERATURE

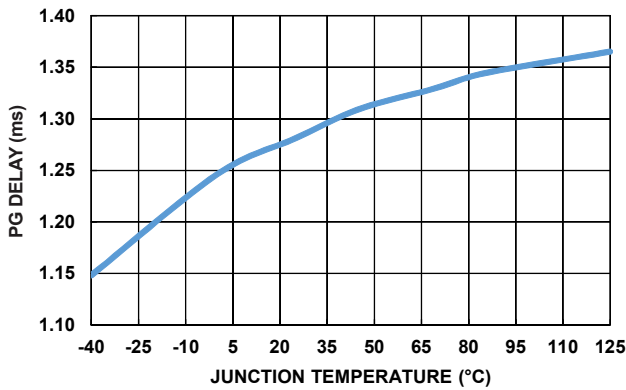

FIGURE 13. PG DELAY vs TEMPERATURE

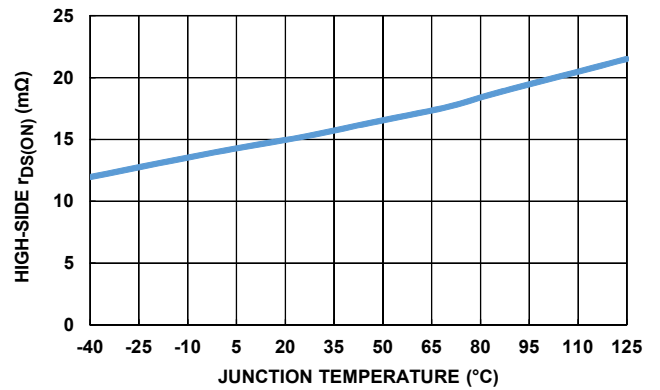

FIGURE 14. HIGH-SIDE $r_{DS(ON)}$ vs TEMPERATURE

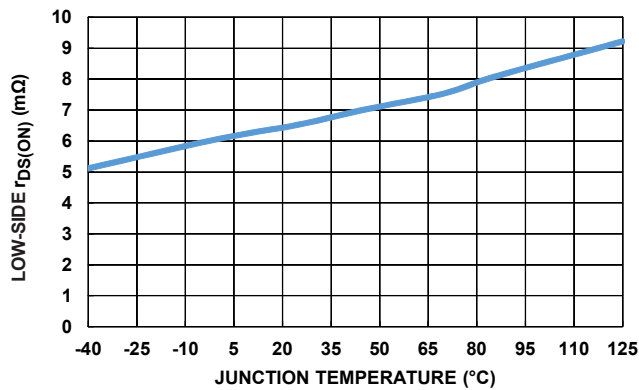

FIGURE 15. LOW-SIDE $r_{DS(ON)}$ vs TEMPERATURE

Typical Performance Curves

Circuit of [Figure 3. Table 1 on page 2](#) shows the components value for different output voltages. Plots are captured from ISL85014EVAL1Z boards. $V_{IN} = 12V$, $V_{OUT} = 1.8V$, $FREQ = 600kHz$, CCM, $T_J = -40^\circ C$ to $+125^\circ C$ unless otherwise noted. Typical values are at $T_A = +25^\circ C$.

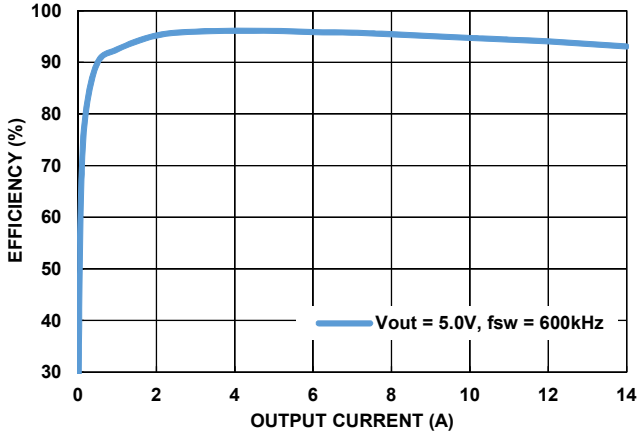

FIGURE 16. EFFICIENCY vs LOAD ($V_{OUT} = 5V$, $f_{SW} = 600kHz$)

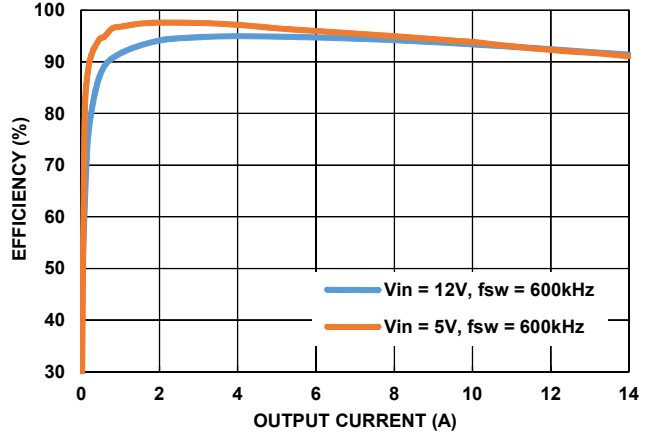

FIGURE 17. EFFICIENCY vs LOAD ($V_{OUT} = 3.3V$, $f_{SW} = 600kHz$)

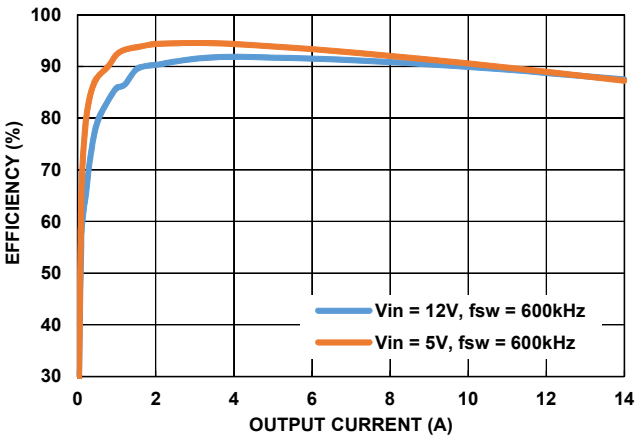

FIGURE 18. EFFICIENCY vs LOAD ($V_{OUT} = 1.8V$, $f_{SW} = 600kHz$)

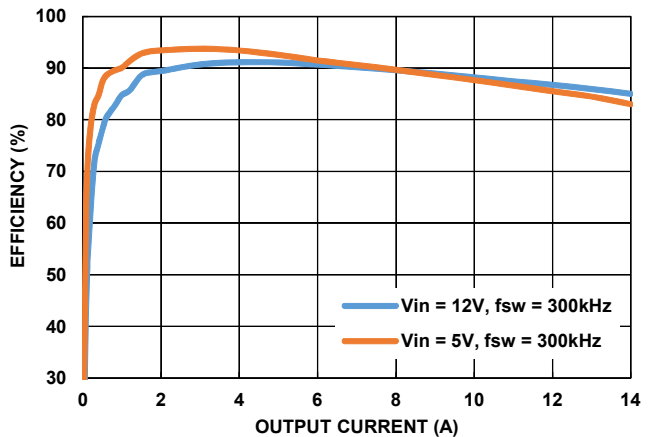

FIGURE 19. EFFICIENCY vs LOAD ($V_{OUT} = 1.2V$, $f_{SW} = 300kHz$)

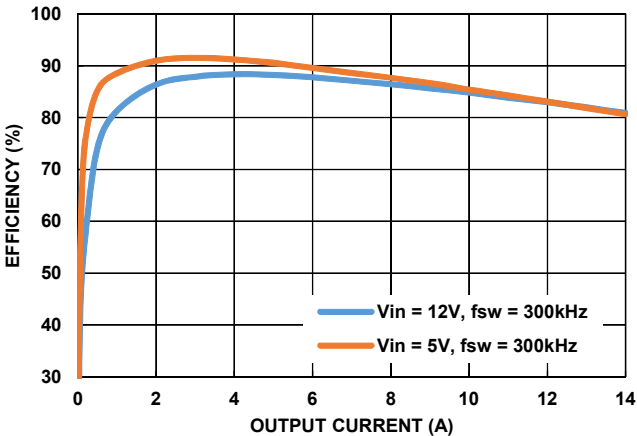

FIGURE 20. EFFICIENCY vs LOAD ($V_{OUT} = 1.0V$, $f_{SW} = 300kHz$)

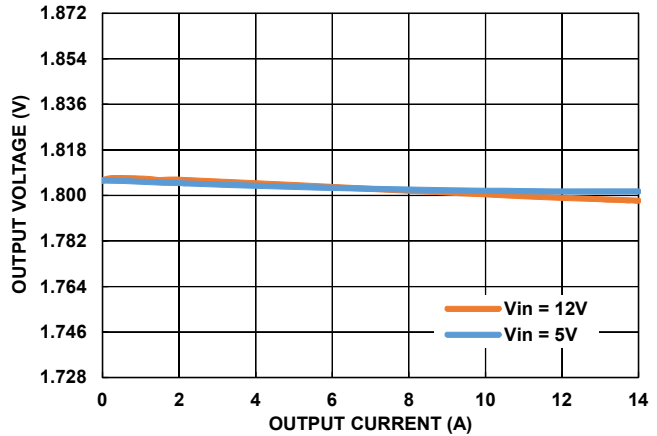

FIGURE 21. V_{OUT} REGULATION vs LOAD ($V_{OUT} = 1.8V$, $f_{SW} = 600kHz$)

Typical Performance Curves

Circuit of [Figure 3. Table 1 on page 2](#) shows the components value for different output voltages. Plots are captured from ISL85014EVAL1Z boards. $V_{IN} = 12V$, $V_{OUT} = 1.8V$, $FREQ = 600kHz$, CCM, $T_J = -40^{\circ}C$ to $+125^{\circ}C$ unless otherwise noted. Typical values are at $T_A = +25^{\circ}C$. (Continued)

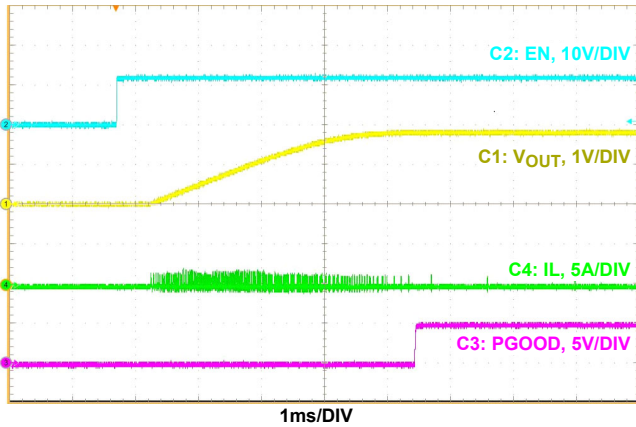

FIGURE 22. START-UP BY EN ($V_{IN} = 12V$, $V_{OUT} = 1.8V$ AT 0A, 600kHz, DCM)

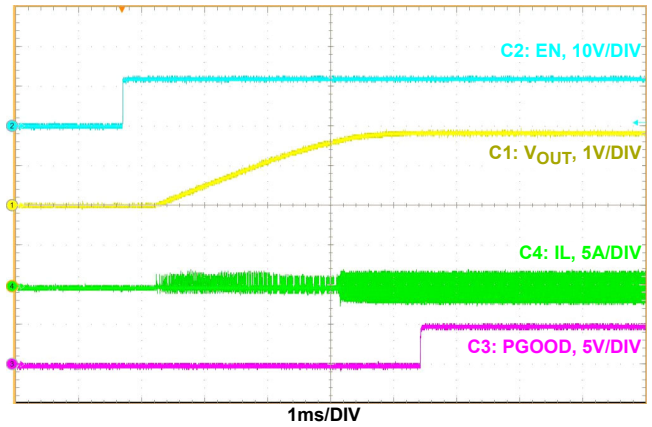

FIGURE 23. START-UP BY EN ($V_{IN} = 12V$, $V_{OUT} = 1.8V$ AT 0A, 600kHz, FCCM)

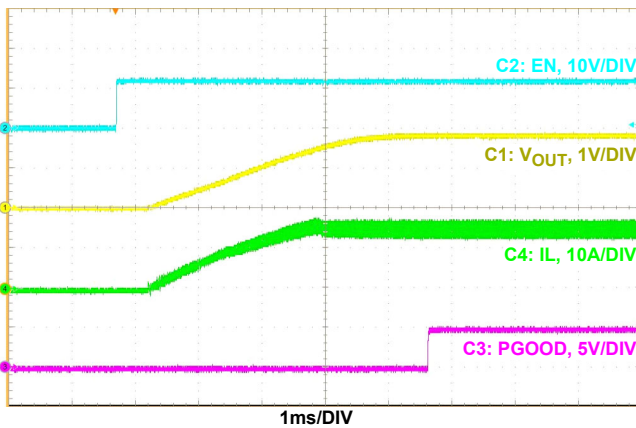

FIGURE 24. START-UP BY EN ($V_{IN} = 12V$, $V_{OUT} = 1.8V$ AT 14A, 600kHz)

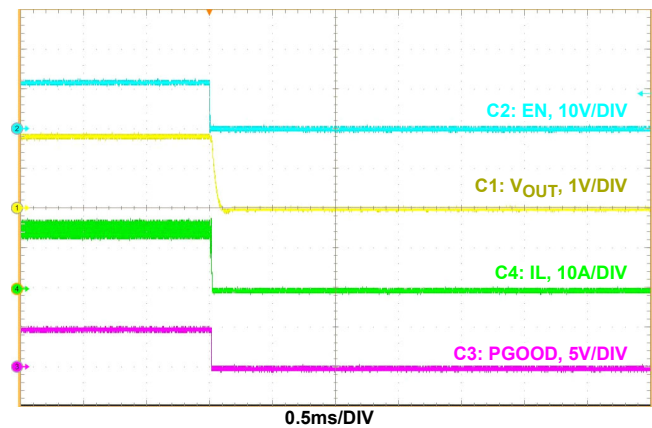

FIGURE 25. SHUTDOWN BY EN ($V_{IN} = 12V$, $V_{OUT} = 1.8V$ AT 14A, 600kHz)

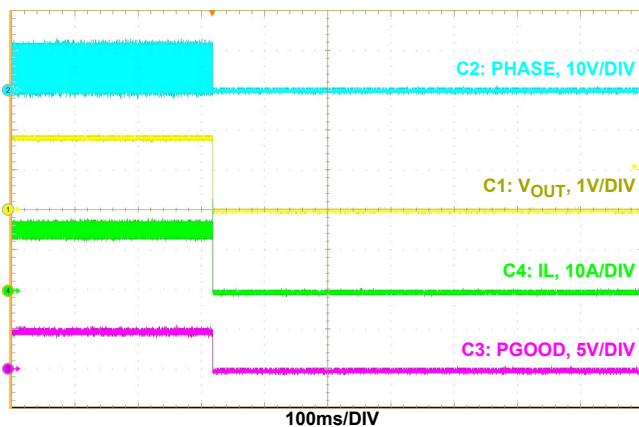

FIGURE 26. LATCH-OFF OCP ($V_{IN} = 12V$, $V_{OUT} = 1.8V$, 600kHz)

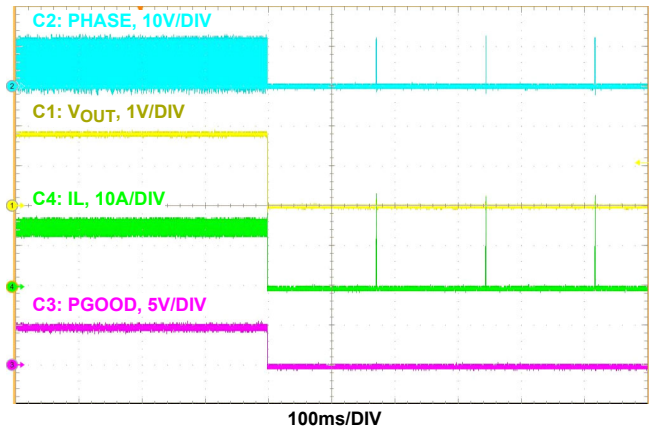

FIGURE 27. HICCUP OCP ($V_{IN} = 12V$, $V_{OUT} = 1.8V$, 600kHz)

Typical Performance Curves

Circuit of [Figure 3](#), [Table 1 on page 2](#) shows the components value for different output voltages. Plots are captured from ISL85014EVAL1Z boards. $V_{IN} = 12V$, $V_{OUT} = 1.8V$, $FREQ = 600kHz$, CCM, $T_J = -40^{\circ}C$ to $+125^{\circ}C$ unless otherwise noted. Typical values are at $T_A = +25^{\circ}C$. (Continued)

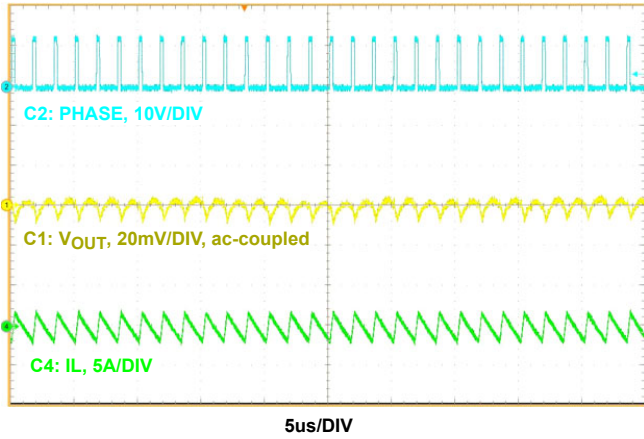

FIGURE 28. OUTPUT VOLTAGE RIPPLE ($V_{IN} = 12V$, $V_{OUT} = 1.8V$ AT 0A, 600kHz, FFCM)

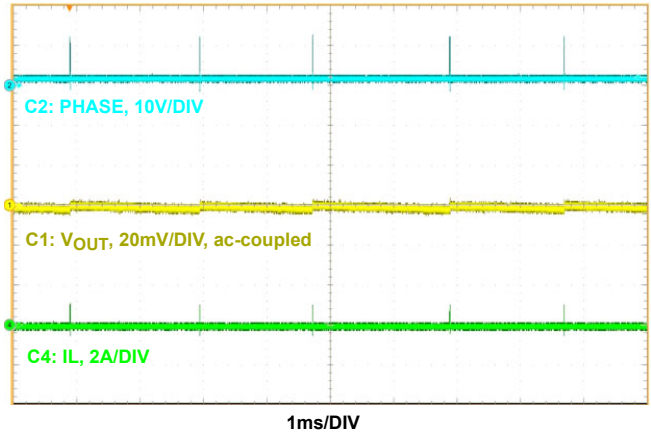

FIGURE 29. OUTPUT VOLTAGE RIPPLE ($V_{IN} = 12V$, $V_{OUT} = 1.8V$ AT 0A, 600kHz, DEM)

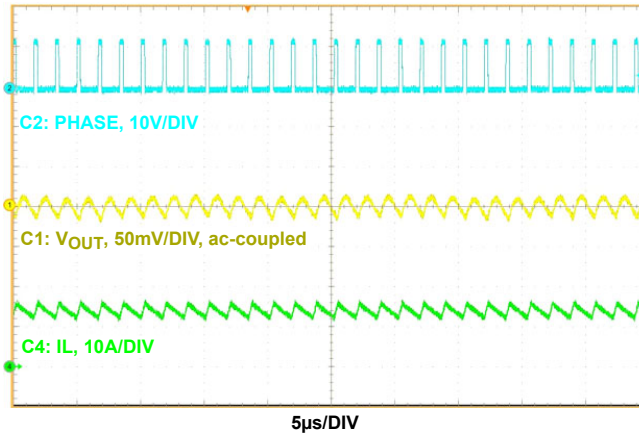

FIGURE 30. OUTPUT VOLTAGE RIPPLE ($V_{IN} = 12V$, $V_{OUT} = 1.8V$ AT 14A, 600kHz)

Detailed Description

The ISL85014 combines a synchronous buck controller with a pair of integrated switching MOSFETs. The buck controller drives the internal high-side and low-side N-channel MOSFETs to deliver load currents up to 14A. The buck regulator can operate from an unregulated DC source, such as a battery, with a voltage ranging from +3.8V to +18V. An internal 5V LDO voltage regulator is used to bias the controller. The converter output voltage is programmed using an external resistor divider and will generate regulated voltages down to 0.6V. These features make the regulator suited for a wide range of applications.

The controller uses a current mode loop, which simplifies the loop compensation and permits fixed frequency operation over a wide range of input and output voltages. The internal feedback loop compensation option allows for simple circuit design. 600kHz (FREQ = float) and 300kHz (FREQ = GND) can be selected as the default switching frequency. The regulator can be synchronized from 100kHz to 1MHz by SYNC pin as well.

The buck regulator is equipped with a lossless current limit scheme. The current in the output stage is derived from temperature compensated measurements of the drain-to-source voltage of the internal power MOSFETs.

Operation Initialization

The power-on reset circuitry and enable inputs prevent false start-up of the PWM regulator output. Once all the input criteria are met (see [Figure 31](#)), the controller soft-starts the output voltage to the programmed level.

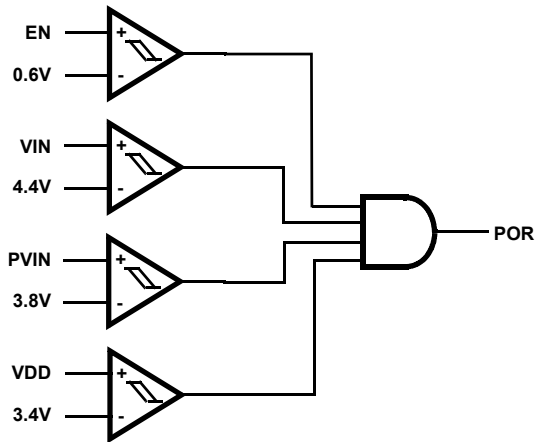

FIGURE 31. POR CIRCUIT

Enable and Soft-Start

Chip operation begins after V_{IN} , PV_{IN} , and V_{DD} exceed their rising POR trip points. If EN is held low externally, nothing happens until this pin is released. Once the voltage on the EN pin is above 0.6V, the LDO powers up and soft-start control begins. The ISL85014 operates with Diode Emulation Mode (DEM) during soft-start regardless of the setting on SYNC pin. The soft-start time is 3ms (typical).

The part is designed to support start-up into a prebiased load (the prebiased voltage is required to be less than the output voltage setting). Both high-side and low-side switches are

disabled until the internal SS voltage exceeds the FB voltage during start-up. It is recommended to connect an RC filter between an external EN input and the EN pin if a long trace or pull up to V_{IN} is used. An RC filter of 100k Ω and 1nF is recommended.

PWM Control Scheme

The ISL85014 employs the current-mode Pulse-Width Modulation (PWM) control scheme for fast transient response. The current loop consists of the oscillator, the PWM comparator, current-sensing circuit, and the slope compensation circuit. The gain of the current-sensing circuit is typically 55mV/A and the slope compensation is 780mV/ t_{SS} (t_{SS} = period). The control reference for the current loop comes from the Error Amplifier's (EA) output, which compares the feedback signal at FB pin to the integrated 0.6V reference.

To use internal compensation, connect COMP to ground via a 200 Ω resistor. When the default frequency 600kHz is used, either by floating the FREQ pin or by applying a 600kHz square wave at the SYNC pin, the voltage loop is internally compensated with a 30pF and 800k Ω RC network. When the frequency is set to 300kHz, the voltage loop is internally compensated with a 30pF and 1200k Ω RC network.

The PWM operation is initialized by the clock from the oscillator. The high-side MOSFET is turned on at the beginning of a PWM cycle and the current in the MOSFET starts to ramp-up. When the sum of the current amplifier CSA and the slope compensation (780mV/ t_{SS}) reaches the control reference of the current loop (COMP), the PWM comparator sends a signal to the PWM logic to turn off the upper MOSFET and turn on the lower MOSFET. The lower MOSFET stays on until the end of the PWM cycle. [Figure 32](#) shows the typical operating waveforms during Continuous Conduction Mode (CCM) operation. The dotted lines illustrate the sum of the compensation ramp and the current-sense amplifier's output.

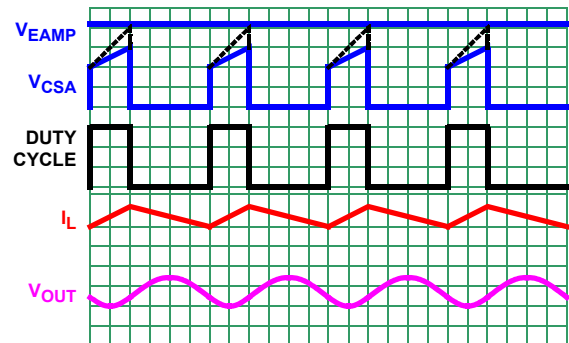

FIGURE 32. PWM OPERATION WAVEFORMS

Light-Load Operation

The ISL85014 monitor both the current in the low-side MOSFET and the voltage of the FB node for regulation. Pulling the SYNC pin low allows the regulator to enter discontinuous operation when lightly loaded by operating the low-side MOSFET in Diode Emulation Mode (DEM). In this mode, reverse current is not allowed in the inductor and the output falls naturally to the regulation voltage before the high-side MOSFET is switched for the next cycle. In CCM mode, the boundary is set by [Equation 1](#):

$$I_{OUT} = \frac{V_{OUT}(1-D)}{2Lf_{SW}} \quad (\text{EQ. 1})$$

where D = duty cycle, f_{SW} = switching frequency, L = inductor value, I_{OUT} = output loading current, and V_{OUT} = output voltage. [Table 3](#) shows the operating modes determined by the SYNC pin.

TABLE 3. OPERATION MODE SETTING

SYNC PIN SETTING	LIGHT-LOAD OPERATION
Float	Forced CCM
GND	DEM

Switching Frequency Setting and Synchronization

The ISL85014's switching frequency can be set by the FREQ pin. Floating the FREQ pin sets the switching frequency to 600kHz, while shorting the FREQ pin to ground sets the switching frequency to 300kHz. The ISL85014 can also be synchronized from 100kHz to 1MHz by an external signal applied to the SYNC pin. The rising edge on the SYNC triggers the rising edge of the PHASE pulse. Make sure the on-time of the SYNC pulse is longer than 100ns.

When floating the FREQ pin for a 600kHz switching frequency, or using synchronizing to an external clock on SYNC pin, along with the internal compensation option (COMP short to GND through a 200Ω resistor), the voltage loop is internally compensated with a 30pF and 800kΩ RC network. A 30pF and 1200kΩ RC network is implemented for internal compensation as it works with FREQ = GND ($f_{SW} = 300\text{kHz}$).

In the applications, the minimum on-time requirement of the regulator limits the range of the switching frequency. The maximum switching frequency can be calculated using [Equation 2](#):

$$f_{SW(\text{Max})} = \frac{V_{OUT}}{V_{IN(\text{MAX})} \cdot \text{mint}_{on}} \quad (\text{EQ. 2})$$

The ISL85014 requires a minimum on-time of 150ns (maximum) for proper output regulation. For example, with a 1V output voltage and 18V maximum input voltage, the switching frequency must be less than 370kHz.

Output Voltage Selection

The regulator output voltages can be programmed using external resistor dividers that scale the voltage feedback relative to the internal reference voltage. The scaled voltage is fed back to the inverting input of the error amplifier; refer to [Figure 33](#).

The output voltage programming resistor, R_2 , will depend on the value chosen for the feedback resistor, R_1 , and the desired output voltage, V_{OUT} ; see [Equation 3](#). The R_1 value will determine the gain of the feedback loop. See "[Loop Compensation Design](#)" on [page 17](#) for more details. The value for the feedback resistor is typically between 1kΩ and 370kΩ.

$$R_2 = \frac{R_1 \cdot 0.6V}{V_{OUT} - 0.6V} \quad (\text{EQ. 3})$$

If the desired output voltage is 0.6V, then R_2 is left unpopulated. R_1 is still required to set the low frequency pole of the modulator compensation.

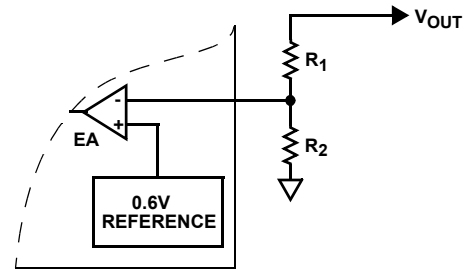

FIGURE 33. EXTERNAL RESISTOR DIVIDER

Protection Features

The regulator limits current in all on-chip power devices. Overcurrent limits are applied to the two output switching MOSFETs as well as to the LDO linear regulator that feeds V_{DD} . The output overvoltage protection circuitry on the switching regulator provides a second layer of protection.

High-Side MOSFET Overcurrent Protection

Current flowing through the internal high-side switching MOSFET is monitored during on-time. The current, which is temperature compensated, will compare to a default 20A overcurrent limit. The ISL85014 offers two OCP schemes to implement the on-time overcurrent protection, which can be configured by the MODE pin (see [Table 4](#)).

TABLE 4. OCP SCHEME SETTING

MODE PIN SETTING	OCP SCHEME
Float	Enters Hiccup mode after eight consecutive cycle-by-cycle limits. Blanking time is 150ms.
GND	Enters Latch-Off mode after eight consecutive cycle-by-cycle limits.

If the measured current exceeds the overcurrent limit, the high-side MOSFET is immediately turned off and will not turn on again until the next switching cycle. After eight consecutive cycles of overcurrent events are detected, the converter will operate at the selected OCP scheme according to the MODE pin configuration. A cycle where an overcurrent condition is not detected will reset the counter.

The switching frequency will be folded back if the OCP is tripped and the on-time of the PWM is less than 250ns to lower down the average inductor current.

Low-Side MOSFET Overcurrent Protection

Low-side current limit consists of forward current limit (from GND to PHASE) and reverse current limit (from PHASE to GND).

Current through the low-side switching MOSFET is sampled during off time. The low-side OCP comparator is flagged if the low-side MOSFET current exceeds 23A (forward). It resets the flag when the current falls below 17A. The PWM will skip cycles when the flag is set allowing the inductor current to decay to a safe level before resuming switching (see [Figure 34](#)).

Similar to the forward overcurrent, the reverse current protection is realized by monitoring the current across the low-side MOSFET. When the low-side MOSFET current reaches -7.5A, the synchronous rectifier is turned off. This limits the ability of the regulator to actively pull-down on the output.

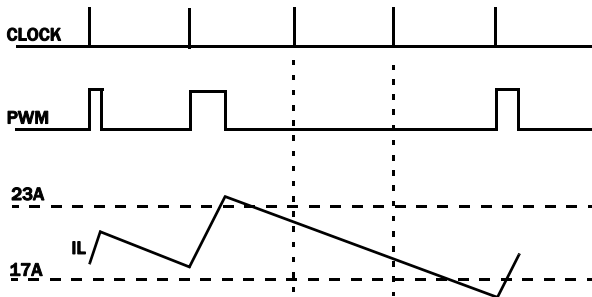

FIGURE 34. LOW-SIDE FORWARD OCP

Output Overvoltage Protection

The overvoltage protection triggers when the output voltage exceeds 116% of the set voltage. In this condition, high-side and low-side MOSFETs are off until the output drops to within the regulation band. Once the output is in regulation, the controller will restart under internal SS control.

Input Overvoltage Protection

The input overvoltage protection system prevents operation of the switching regulator whenever the input voltage is higher than 20V. The high-side and low-side MOSFETs are off and the converter will restart under internal SS control when the input voltage returns to normal.

Thermal Overload Protection

Thermal overload protection limits the maximum die temperature, and thus the total power dissipation in the regulator. A sensor on the chip monitors the junction temperature. A signal is sent to the fault monitor circuits whenever the junction temperature (T_j) exceeds +160°C, which causes the switching regulator and LDO to shut down.

The switching regulator turns on again and soft-starts after the IC's junction temperature cools by 10°C. The switching regulator exhibits Hiccup mode operation during continuous thermal overload conditions. For continuous operation, do not exceed the +125°C junction temperature rating.

BOOT Undervoltage Detection

The internal driver of the high-side FET is equipped with a BOOT Undervoltage (UV) detection circuit. In the event the voltage difference between BOOT and PHASE falls below 2.8V, the UV detection circuit allows the low-side MOSFET on for 250ns, to recharge the bootstrap capacitor.

While the ISL85014 includes an internal bootstrap diode, efficiency can be improved by using an external supply voltage and bootstrap Schottky diode. The external diode is then sourced from a fixed external 5V supply or from the output of the switching regulator if this is at 5V. The bootstrap diode can be a low cost type, such as the BAT54 (see [Figure 35](#)).

Power-Good

ISL85014 has a Power-Good (PG) indicator which is an open drain of a MOSFET. It requires pull-up to VDD or other voltage source lower than 5.5V through a resistor (usually from 10k to 100kΩ). The PG asserted 1.5ms after the FB voltage reaches 90% of the reference voltage in soft-start. It pulls low if the FB voltage drops to 87% of the reference voltage or exceeds 116% of the reference voltage during the normal operation. Disabling the part also pulls the PG low. The PG will reassert when the FB voltage drops back to 113% (100%) of the reference voltage after tripping the overvoltage protection when SYNC is low (float/high).

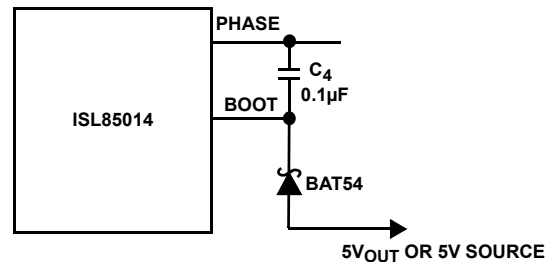

FIGURE 35. EXTERNAL BOOTSTRAP DIODE

Application Guidelines

Buck Regulator Output Capacitor Selection

An output capacitor is required to filter the inductor current and supply the load transient current. The filtering requirements are a function of the switching frequency, the ripple current, and the required output ripple. The load transient requirements are a function of the slew rate (di/dt) and the magnitude of the transient load current. These requirements are generally met with a mix of capacitor types and careful layout.

High frequency ceramic capacitors initially supply the transient and slow the current load rate seen by the bulk capacitors. The bulk filter capacitor values are generally determined by the Equivalent Series Resistance (ESR) and voltage rating requirements rather than actual capacitance requirements.

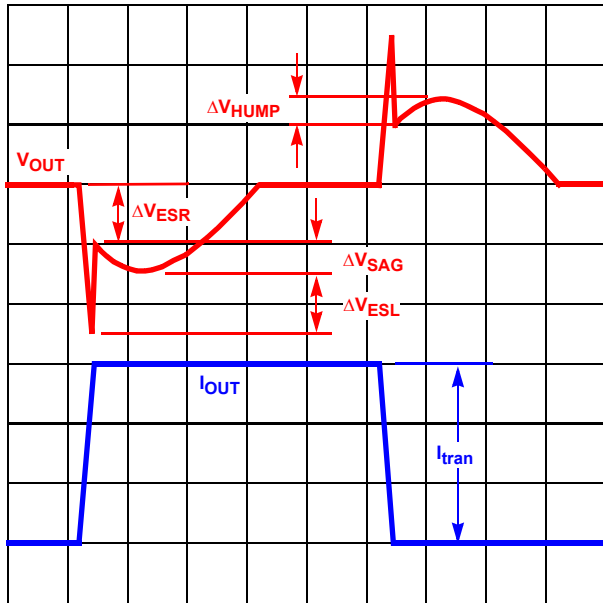

FIGURE 36. TYPICAL TRANSIENT RESPONSE

High frequency decoupling capacitors should be placed as close to the power pins of the load as physically possible. Be careful not to add inductance in the circuit board wiring that could cancel the usefulness of these low inductance components. Consult with the manufacturer of the load on specific decoupling requirements.

The shape of the output voltage waveform during a load transient that represents the worst case loading conditions will ultimately determine the number of output capacitors and their type. When this load transient is applied to the converter, most of the energy required by the load is initially delivered from the output capacitors. This is due to the finite amount of time required for the inductor current to slew up to the level of the output current required by the load. This phenomenon results in a temporary dip in the output voltage. At the very edge of the transient, the Equivalent Series Inductance (ESL) of each capacitor induces a spike that adds on top of the existing voltage drop due to the Equivalent Series Resistance (ESR).

After the initial spike, attributable to the ESR and ESL of the capacitors, the output voltage experiences sag. This sag is a direct consequence of the amount of capacitance on the output.

During the removal of the same output load, the energy stored in the inductor is dumped into the output capacitors. This energy dumping creates a temporary hump in the output voltage. This hump, as with the sag, can be attributed to the total amount of capacitance on the output. [Figure 36](#) shows a typical response to a load transient.

The amplitudes of the different types of voltage excursions can be approximated using [Equations 4, 5, 6, and 7](#).

$$\Delta V_{ESR} = ESR \cdot I_{TRAN} \quad (\text{EQ. 4})$$

$$\Delta V_{ESL} = ESL \cdot \frac{I_{TRAN}}{dt} \quad (\text{EQ. 5})$$

$$\Delta V_{SAG} = \frac{L_{OUT} \cdot I_{TRAN}^2}{2C_{OUT} \cdot (V_{IN} - V_{OUT})} \quad (\text{EQ. 6})$$

$$\Delta V_{HUMP} = \frac{L_{OUT} \cdot I_{TRAN}^2}{2C_{OUT} \cdot V_{OUT}} \quad (\text{EQ. 7})$$

where I_{TRAN} = Output Load Current Transient and C_{OUT} = Total Output Capacitance.

In a typical converter design, the ESR of the output capacitor bank dominates the transient response. The ESR and the ESL are typically the major contributing factors in determining the output capacitance. The number of output capacitors can be determined by using [Equation 8](#), which relates the ESR and ESL of the capacitors to the transient load step and the tolerable output voltage excursion during load transient (ΔV_O):

$$\text{Number of Capacitors} = \frac{ESL \cdot I_{TRAN} + ESR \cdot I_{TRAN}}{dt \cdot \Delta V_{OUT}} \quad (\text{EQ. 8})$$

If ΔV_{SAG} and/or ΔV_{HUMP} are found to be too large for the output voltage limits, then the amount of capacitance may need to be increased. In this situation, a trade-off between output inductance and output capacitance may be necessary.

The ESL of the capacitors, which is an important parameter in the previous equations, is not usually listed in specification. Practically, it can be approximated using [Equation 9](#) if an Impedance vs Frequency curve is given for a specific capacitor:

$$ESL = \frac{1}{C(2 \cdot \pi \cdot f_{res})^2} \quad (\text{EQ. 9})$$

where f_{res} is the frequency where the lowest impedance is achieved (resonant frequency).

The ESL of the capacitors becomes a concern when designing circuits that supply power to loads with high rates of change in the current.

Output Inductor Selection

The output inductor is selected to meet the output voltage ripple requirements and minimize the converter's response time to the load transient. The inductor value determines the converter's ripple current and the ripple voltage is a function of the ripple current. The ripple voltage and current are approximated by [Equations 10 and 11](#):

$$\Delta I = \frac{(V_{IN} - V_{OUT})}{f_{SW} \cdot L} \cdot \frac{V_{OUT}}{V_{IN}} \quad (\text{EQ. 10})$$

$$\Delta V_{OUT} = \Delta I \cdot ESR \quad (\text{EQ. 11})$$

Increasing the value of inductance reduces the ripple current and voltage. However, the large inductance values reduce the converter's response time to a load transient. It is recommended to set the ripple inductor current to approximately 30% of the maximum output current for optimized performance. It is recommended that the design of the inductor ripple current does not exceed 6A in the applications of ISL85014.

One of the parameters limiting the converter's response to a load transient is the time required to change the inductor current. Given a sufficiently fast control loop design, the ISL85014 will provide either 0% or 100% duty cycle in response to a load transient. The response time is the time required to slew the inductor current from an initial current value to the transient current level. During this interval, the difference between the inductor current and the transient current level must be supplied by the output capacitor. Minimizing the response time can minimize the output capacitance required.

The response time to a transient is different for the application of load and the removal of load. Equations 12 and 13 give the approximate response time interval for application and removal of a transient load:

$$t_{RISE} = \frac{L \cdot I_{TRAN}}{V_{IN} - V_{OUT}} \quad (EQ. 12)$$

$$t_{FALL} = \frac{L \cdot I_{TRAN}}{V_{OUT}} \quad (EQ. 13)$$

where I_{TRAN} is the transient load current step, t_{RISE} is the response time to the application of load, and t_{FALL} is the response time to the removal of load. The worst case response time can be either at the application or removal of load. Be sure to check both of these equations at the minimum and maximum output levels for the worst case response time.

With the overcurrent protection thresholds of 20A (typical) on the high-side MOSFET and 23A (typical) on the low-side MOSFET, it is recommended to use the inductor with saturated current higher than 23A. Metal alloy powder material core inductors are typically recommended due to their better saturation characteristics.

Input Capacitor Selection

Use a mix of input bypass capacitors to control the input voltage ripple. Use ceramic capacitors for high frequency decoupling and bulk capacitors to supply the current needed each time the switching MOSFET turns on. Place the ceramic capacitors physically close to the MOSFET VIN pins (switching MOSFET drain) and PGND.

The important parameters for the bulk input capacitance are the voltage rating and the RMS current rating. For reliable operation, select bulk capacitors with voltage and current ratings above the maximum input voltage and largest RMS current required by the circuit. Their voltage rating should be at least 1.25 times greater than the maximum input voltage, while a voltage rating of 1.5 times is a conservative guideline. For most cases, the RMS current rating requirement for the input capacitor of a buck regulator is approximately 1/2 the DC load current.

The maximum RMS current required by the regulator may be closely approximated through Equation 14:

$$I_{RMS_MAX} = \sqrt{\frac{V_{OUT}}{V_{IN}} \cdot \left(I_{OUT_MAX}^2 + \frac{1}{12} \cdot \left(\frac{V_{IN} - V_{OUT}}{L \cdot f_{SW}} \cdot \frac{V_{OUT}}{V_{IN}} \right)^2 \right)} \quad (EQ. 14)$$

For a through-hole design, several electrolytic capacitors may be needed, especially at temperatures less than -25 °C. The electrolytic's ESR can increase ten times higher than at room temperature and cause input line oscillation. In this case, a more thermally stable capacitor such as X7R ceramic should be used. For surface mount designs, solid tantalum capacitors can be used, but caution must be exercised with regard to the capacitor surge current rating. Some capacitor series available from reputable manufacturers are surge current tested.

Loop Compensation Design

When COMP is not connected to GND through a 200Ω resistor, the COMP pin is active for external loop compensation. The regulator uses constant frequency peak current mode control architecture to achieve a fast loop transient response. An accurate current sensing pilot device in parallel with the high-side switch is used for peak current control signal and overcurrent protection. The inductor is not considered as a state variable since its peak current is constant, and the system becomes a single order system. It is much easier to design a Type II compensator to stabilize the loop than to implement voltage mode control. Peak current mode control has an inherent input voltage feed-forward function to achieve good line regulation. Figure 37 shows the small signal model of the synchronous buck regulator.

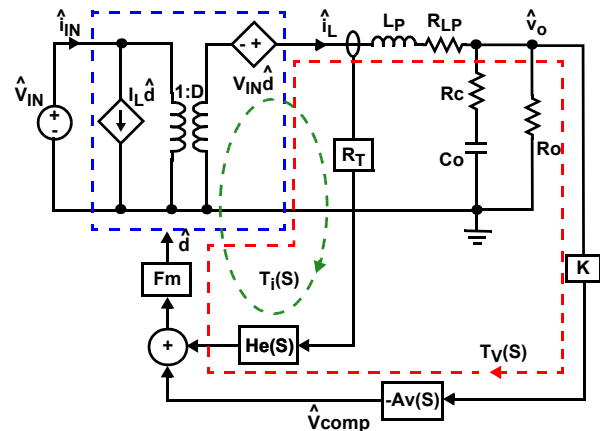

FIGURE 37. SMALL SIGNAL MODEL OF SYNCHRONOUS BUCK REGULATOR

To simplify the analysis, sample and hold effect block $He(s)$ and slope compensation are not taken into account. Assume V_{comp} is equal to the current sense signal $I_L \times R_T$ and ignore the DCR of the inductor, the power train can be approximated by a voltage controlled current source supplying current to the output capacitor and load resistor (see Figure 38). The transfer function frequency response is presented in Figure 39.

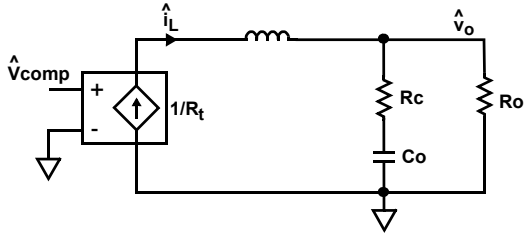

FIGURE 38. POWER TRAIN SMALL SIGNAL MODEL

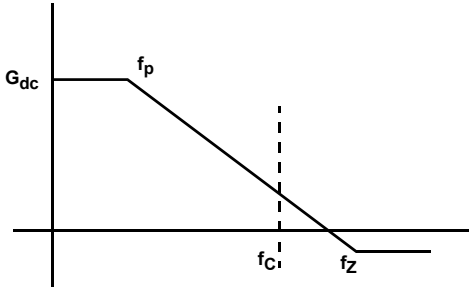

FIGURE 39. POWER TRAIN SMALL FREQUENCY RESPONSE

The simplified transfer function is derived in [Equation 15](#):

$$G_p(S) = \frac{\hat{V}_o}{\hat{V}_{comp}} = G_{dc} \frac{1 + \frac{S}{\omega_z}}{1 + \frac{S}{\omega_p}} \quad (\text{EQ. 15})$$

where:

$$G_{dc} = \frac{R_o}{R_t}; \omega_z = 2\pi f_z = \frac{1}{R_c \times C_o}; \omega_p = 2\pi f_p = \frac{1}{(R_o + R_c) \times C_o} \quad (\text{EQ. 16})$$

Note that C_o is the actual capacitance seen by the regulator, which may include ceramic high frequency decoupling and bulk output capacitors. Ceramic capacitors may have to be derated by approximately 40% depending on dielectric, voltage stress, and temperature.

Usually, a Type II compensation network is used to compensate the peak current mode control converter. [Figure 40](#) shows a typical Type II compensation network and its transfer function is expressed in [Equation 17](#). The frequency response is shown in [Figure 41](#).

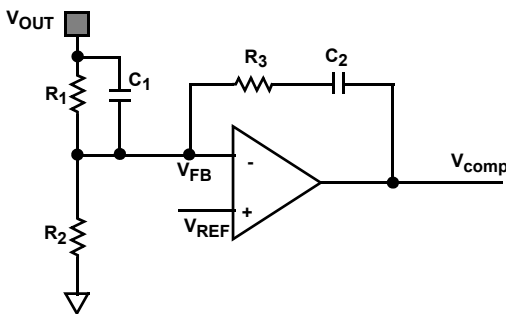

FIGURE 40. TYPE II COMPENSATION NETWORK

$$A_v(S) = \frac{\hat{V}_{comp}}{\hat{V}_o} = \frac{\left(1 + \frac{S}{\omega_{cz1}}\right)\left(1 + \frac{S}{\omega_{cz2}}\right)}{S C_2 R_1} \quad (\text{EQ. 17})$$

where:

$$\omega_{cz1} = 2\pi f_{z1} = \frac{1}{R_3 C_2}, \omega_{cz2} = 2\pi f_{z2} = \frac{1}{R_1 C_1}, f_{pc} = \frac{1}{2\pi R_1 C_2}$$

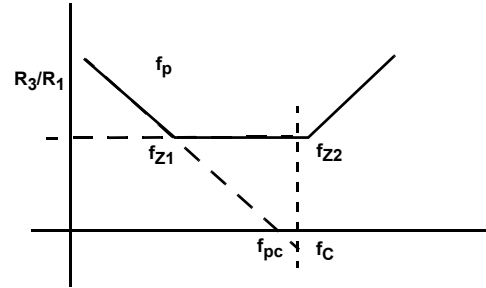

FIGURE 41. TYPE II COMPENSATION FREQUENCY RESPONSE

Design example: $V_{IN} = 12V, V_O = 1.8V, I_O = 14A, f_{SW} = 600kHz, R_1 = 200k\Omega, R_2 = 100k\Omega, C_o = 4 \times 100\mu F / 3m\Omega$ 6.3V ceramic (actually $\sim 200\mu F$), $L = 0.68\mu H$,

Select $f_c = 60kHz$. The gain of the $G_p(s) \times A_v(s)$ should have a unity gain at crossover frequency. Thus, R_3 can be derived as:

$$R_3 = 2\pi f_c C_o R_1 R_1 = 829k\Omega \quad (\text{EQ. 18})$$

Select $800k\Omega$ for R_3 . Place the zero f_{z1} around the pole f_p to achieve $-20db/dec$ roll off.

$$C_2 = \frac{(R_o + R_c) \times C_o}{R_3} = 33pF \quad (\text{EQ. 19})$$

where R_c is the ESR of the output capacitor.

Select $30pF$ for C_2 . Zero f_{z2} is a phase boost zero to increase the phase margin. Place it between f_c and $1/2$ switching frequency. In this case, the ESR zero is calculated to determine if a feed-forward capacitor is required to introduce phase boost.

$$f_{zesr} = \frac{1}{2\pi R_c C_o} = 265kHz \quad (\text{EQ. 20})$$

Since the ESR zero falls between f_c and $1/2$ switching frequency, an additional zero using C_1 may not be required. The calculated values for $R_1, R_2, R_3,$ and C_2 match with the $1.8V$ output application in the recommended design with internal compensation shown in [Table 1 on page 2](#). Do not select resistance higher than $370k\Omega$ for R_1 in real applications, since it will result in a very small C_1 , which might be overwhelmed by parasitic capacitances.

In practice, it is recommended to select lower resistance for R_1/R_2 and R_3 in the external compensation applications. Usually, 10 times lower compared with the internal compensation is a good start.

Layout Considerations

The layout is very important in high frequency switching converter design. With power devices switching efficiently at 600kHz, the resulting current transitions from one device to another causes voltage spikes across the devices and other circuit elements. These voltage spikes can degrade efficiency, radiate noise into the circuit, and lead to device overvoltage stress. Careful component layout and printed circuit board design minimizes these voltage spikes.

As an example, consider the turn-off transition of the upper MOSFET. Prior to turn-off, the MOSFET is carrying the full load current. During turn-off, current transfers from the MOSFET to the internal body diode of the adjacent MOSFET. Any parasitic inductance in the switched current path generates a large voltage spike during the switching interval. Careful component selection, tight layout of the critical components, and short, wide traces minimize the magnitude of voltage spikes.

A multilayer printed circuit board is recommended. [Figures 42](#) and [43](#) show the recommended layout of the top layer and the inner layer 1 of the schematic in [Figure 1 on page 1](#).

1. Place the input ceramic capacitors between PVIN and GND pins. Put them as close to the pins as possible.
2. A 1 μ F decoupling input ceramic capacitor is recommended. Place it as close to the VIN pin as possible.
3. A 2.2 μ F decoupling ceramic capacitor is recommended for VDD pin. Place it as close to the VDD pin as possible.
4. The entire inner Layer 1 is recommended to be the GND plane to reduce the noise coupling.
5. The switching node (PHASE) plane needs to be kept away from the feedback network. Place the resistor divider close to the IC.
6. Put three to five vias on the GND pin to connect the GND plane of other layers for better thermal performance. This allows the heat to move away from the IC. Keep the vias small enough to prevent solder wicking through the holes during reflow. An 8 mil hole with 15 mil diameter vias are used on the evaluation board. Do not use “thermal relief” patterns to connect the vias. It is important to have a complete connection of the plated-through hole to each plane.

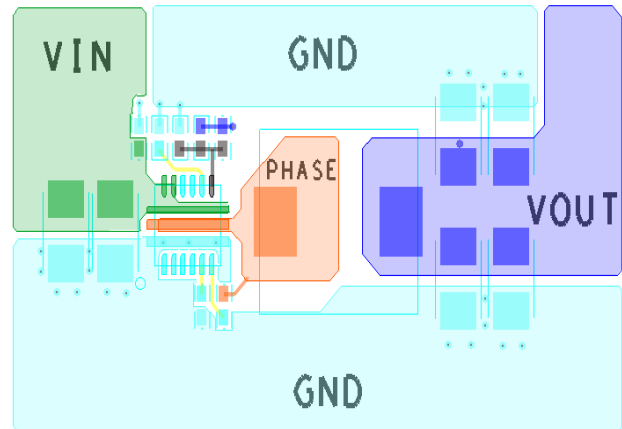

FIGURE 42. RECOMMENDED TOP LAYER LAYOUT

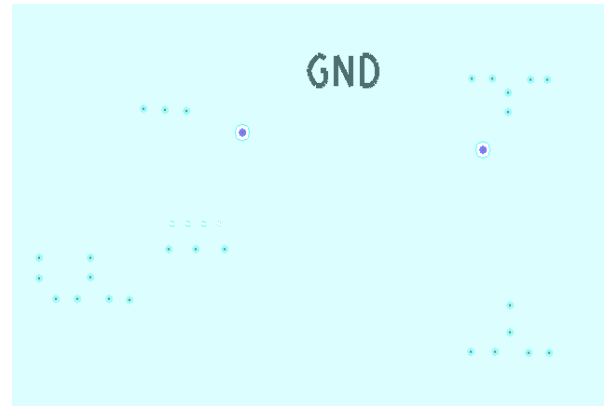

FIGURE 43. SOLID GND PLANE OF INNER LAYER 1

Revision History The revision history provided is for informational purposes only and is believed to be accurate, but not warranted. Please visit our website to make sure that you have the latest revision.

DATE	REVISION	CHANGE
Nov 11, 2021	3.00	Removed Related Literature section. Updated the ordering information table formatting. Updated POD L15.3.5x3.5 to the latest version, changes are as follows: -Revised pin#1 L-shape width from 0.37 to 0.4 to reflect actual dimension.
Jul 30, 2020	2.00	Updated links throughout. Updated the abs max section by changing the maximum rating of the following from +24V to +22V <ul style="list-style-type: none"> • VIN, EN to GND • PVIN to GND • PHASE to GND (DC) • PHASE to GND —(40ns) On page 7 changed the FB Regulation Voltage parameter minimum value from 0.588 to 0.5895 and the maximum value from 0.612 to 0.6105. Removed About Intersil section
Mar 17, 2017	1.00	In "Power-Good" on page 15, updated 88% to 87% and 114% to 113%. Updated verbiage above Equation 8. Updated Equations 11 and 20. Updated verbiage above Equations 18 (changed 260μF to 200μF).
Feb 14, 2017	0.00	Initial Release

Package Outline Drawing

For the most recent package outline drawing, see [L15.3.5x3.5](#).

L15.3.5x3.5

15 Lead Thin Quad Flat No-Lead Package (TQFN)

Rev 3, 10/2021

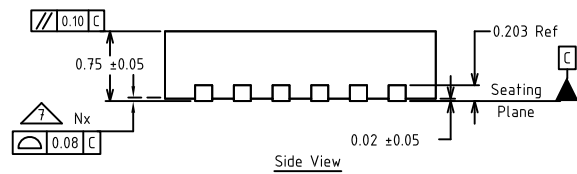
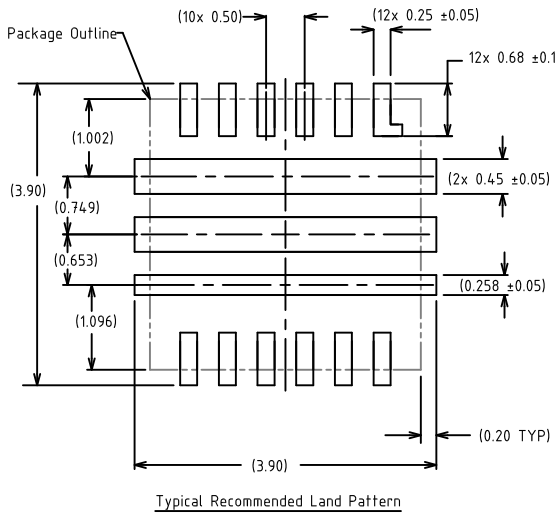
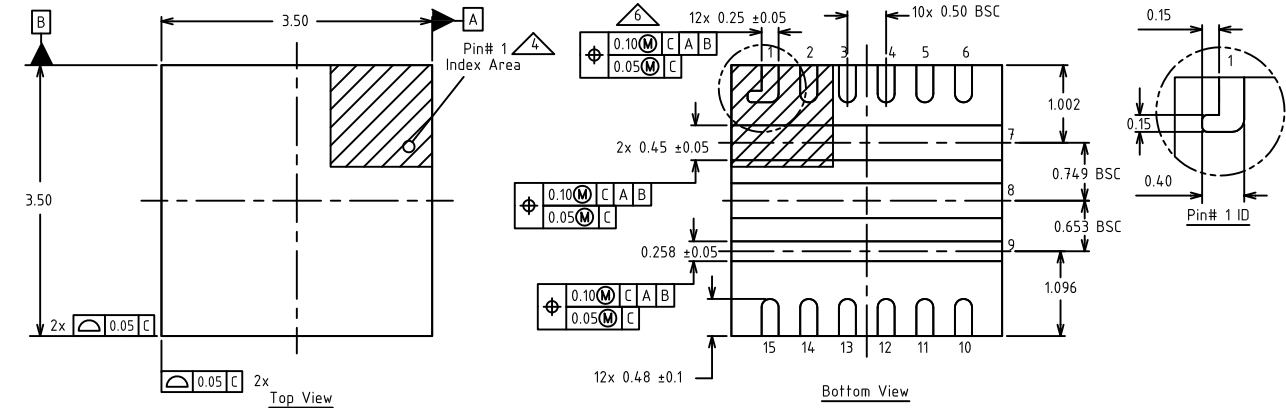

NOTES:

1. Dimensioning and tolerancing conform to ASME Y14.5-2009.
2. All dimensions are in millimeters.
3. N is the total number of terminals.
4. The location of the marked terminal #1 identifier is within the hatched area.
5. ND and NE refer to the number of terminals on D and E side respectively.
6. Dimension applies to metallized terminal and is measured between 0.15mm and 0.30mm from the terminal tip. If the terminal has a radius on the other end of it, dimension b should not be measured in that radius area.
7. Coplanarity applies to the terminals and all other bottom surface metallization.

IMPORTANT NOTICE AND DISCLAIMER

RENESAS ELECTRONICS CORPORATION AND ITS SUBSIDIARIES (“RENESAS”) PROVIDES TECHNICAL SPECIFICATIONS AND RELIABILITY DATA (INCLUDING DATASHEETS), DESIGN RESOURCES (INCLUDING REFERENCE DESIGNS), APPLICATION OR OTHER DESIGN ADVICE, WEB TOOLS, SAFETY INFORMATION, AND OTHER RESOURCES “AS IS” AND WITH ALL FAULTS, AND DISCLAIMS ALL WARRANTIES, EXPRESS OR IMPLIED, INCLUDING, WITHOUT LIMITATION, ANY IMPLIED WARRANTIES OF MERCHANTABILITY, FITNESS FOR A PARTICULAR PURPOSE, OR NON-INFRINGEMENT OF THIRD PARTY INTELLECTUAL PROPERTY RIGHTS.

These resources are intended for developers skilled in the art designing with Renesas products. You are solely responsible for (1) selecting the appropriate products for your application, (2) designing, validating, and testing your application, and (3) ensuring your application meets applicable standards, and any other safety, security, or other requirements. These resources are subject to change without notice. Renesas grants you permission to use these resources only for development of an application that uses Renesas products. Other reproduction or use of these resources is strictly prohibited. No license is granted to any other Renesas intellectual property or to any third party intellectual property. Renesas disclaims responsibility for, and you will fully indemnify Renesas and its representatives against, any claims, damages, costs, losses, or liabilities arising out of your use of these resources. Renesas' products are provided only subject to Renesas' Terms and Conditions of Sale or other applicable terms agreed to in writing. No use of any Renesas resources expands or otherwise alters any applicable warranties or warranty disclaimers for these products.

(Rev.1.0 Mar 2020)

Corporate Headquarters

TOYOSU FORESIA, 3-2-24 Toyosu,
Koto-ku, Tokyo 135-0061, Japan
www.renesas.com

Contact Information

For further information on a product, technology, the most up-to-date version of a document, or your nearest sales office, please visit:
www.renesas.com/contact/

Trademarks

Renesas and the Renesas logo are trademarks of Renesas Electronics Corporation. All trademarks and registered trademarks are the property of their respective owners.