

Fast Switching SCR T707_33

325A Avg.
(500 RMS)
Up to 800 Volts
10-50 μ s

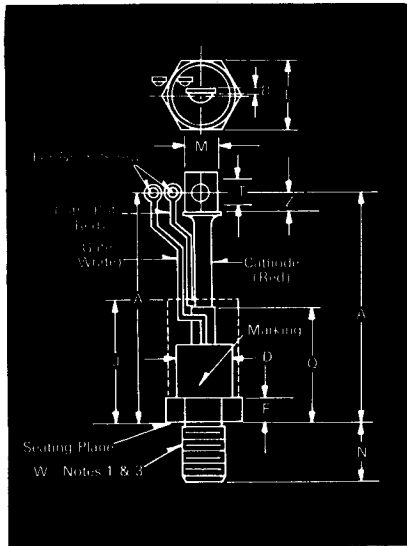

T70 Outline

Features:

- Center fired di/damic gate
- High di/dt with soft gate control
- High frequency operation
- Sinusoidal waveform operation to 20 KHz
- Rectangular waveform operation to 20 KHz
- Low dynamic forward voltage drop
- Low switching losses at high frequency
- Westinghouse Lifetime Guarantee

Ordering Information

Type	Voltage		Current		Turn-off		Gate current		Leads		
Code	V _{DRM} and V _{RRM} (V)	Code	I _{T(av)} (A)	Code	t _q usec	Code	I _{GT} (ma)	Code	Case	Code	
T707	100	01	325	33	10	8	150	4	T70	BY	
	200	02			15						7
	300	03			20						6
	400	04			25						5
	500	05			30						5
	600	06			40						4
	700	07			50						3
	800	08									

Example

Obtain optimum device performance for your application by selecting proper Order Code.

Type T 707 rated at 325A average with V_{DRM} = 700V.
I_{GT} = 150 ma, t_q = 10 μ sec and standard flex lead — order as

Type	Voltage	Current	Turn Off	Gate Current	Leads
T 7 0 7	0 7	3 3	8	4	B Y

Symbol	Inches		Millimeters	
	Min.	Max.	Min.	Max.
A	9.76	10.00	247.90	254.00
A ₁	10.18	10.42	258.57	264.67
B	.063	.172	1.60	4.37
ϕ D		1.490		37.85
E	1.620	1.750	41.15	44.45
F	.430	.810	10.92	20.57
J	4.000		101.60	
M	.530	.755	13.46	19.18
N	1.04	1.08	26.42	27.43
Q		3.100		78.74
ϕ T	.330	.350	8.38	8.89
Z	.440		11.18	
ϕ W	3/16 UNF-2A			

Creep Distance—1.76 in. min. (44.91 mm).
Strike Distance—.81 in. min. (20.70 mm).
(In accordance with NEMA standards.)
Finish—Nickel Plate.

Approx. Weight—16 oz. (454 g).

1. Complete threads to extend to within 2½ threads of seating plane.
2. Angular orientation of terminals is undefined.
3. Pitch diameter of 3/16 UNF-2A (coated) threads (ASA B1.1-1960).
4. Dimension "J" denotes seated height with leads bent at right angles.

Applications:

- Inverters for UPS
- Induction heating
- AC motor drives
- Cycloconverters
- Choppers
- Crowbar

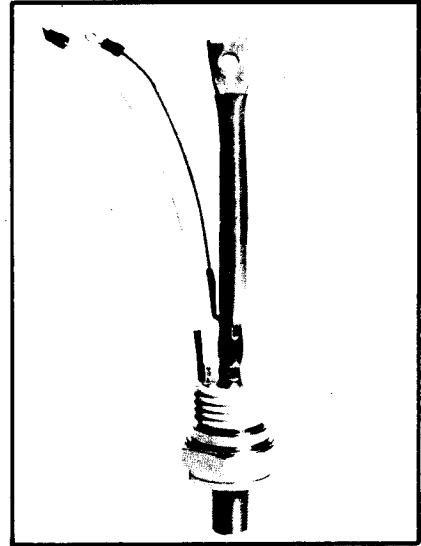

325A Avg.
(500 RMS)
Up to 800 Volts
10-50 μ s

Fast Switching SCR T707_33

Voltage

Blocking State Maximums^① ($T_J = 125^\circ\text{C}$)

Symbol	100	200	300	400	500	600	700	800
Repetitive peak forward blocking voltage, V	100	200	300	400	500	600	700	800
Repetitive peak reverse voltage, V	100	200	300	400	500	600	700	800
Non-repetitive transient peak reverse voltage, $t \leq 5.0$ msec, V	200	300	400	500	600	700	800	900
Forward leakage current, mA peak	← 30 →							
Reverse leakage current, mA peak	← 30 →							

100	200	300	400	500	600	700	800
100	200	300	400	500	600	700	800
200	300	400	500	600	700	800	900
← 30 →							
← 30 →							

Current

Conducting State Maximums
($T_J = 125^\circ\text{C}$)

Symbol	T707_33
RMS forward current, A	500
Ave. forward current, A	325
One-half cycle surge current ^② , A	8000
I^2t for fusing (for times ≥ 8.3 ms) A ² sec.	265000
Forward voltage drop at $I_T = 625$ A and $T_J = 25^\circ\text{C}$, V	1.40
Min. repetitive di/dt , A/ μ sec ^① ④⑤	400

Switching

($T_J = 25^\circ\text{C}$)

Symbol	10 to 50
Max. turn-off time, $I_T = 400$ A, $T_J = 125^\circ\text{C}$, $di/dt = 25$ A/ μ sec, reappplied $dv/dt =$ 20V/ μ sec. linear to .8V DRM, μ sec ^③ ④	10 to 50
Typ. turn-on time, $I_T = 1000$ A, $V_D = 300$ V, μ sec	3.0
Min. critical dv/dt , exponential to V_{DRM} , $T_J = 125^\circ\text{C}$, V/ μ sec ^③ ④	300
Min. di/dt , non-repetitive, ^① ④⑤ A/ μ sec	800

Gate

Maximum Parameters
($T_J = 25^\circ\text{C}$)

Symbol	150
Gate current to trigger at $V_D = 12$ V, mA	150
Gate voltage to trigger at $V_D = 12$ V, V	3
Non-triggering gate voltage, $T_J = 125^\circ\text{C}$, and rated V_{DRM} , V	0.15
Peak forward gate current, A	4
Peak reverse gate voltage, V	5
Peak gate power, Watts	16
Average gate power, Watts	3

Thermal and Mechanical

Symbol	-40 to +125
Min., Max. oper. junction temp., $^\circ\text{C}$	-40 to +125
Min., Max. storage temp., $^\circ\text{C}$	-40 to +150
Max. mounting torque, in lb. ^①	360
Max. Thermal resistance ^①	
Junction to case, $^\circ\text{C}/\text{Watt}$.10
Case to sink, lubricated, $^\circ\text{C}/\text{Watt}$.05

- ① Consult recommended mounting procedures.
- ② Applies for zero or negative gate bias.
- ③ Per JEDEC RS-397, 5.2.2.1.
- ④ With recommended gate drive.
- ⑤ Higher dv/dt ratings available, consult factory.
- ⑥ Per JEDEC standard RS-397, 5.2.2.6.
- ⑦ For operation with antiparallel diode, consult factory.

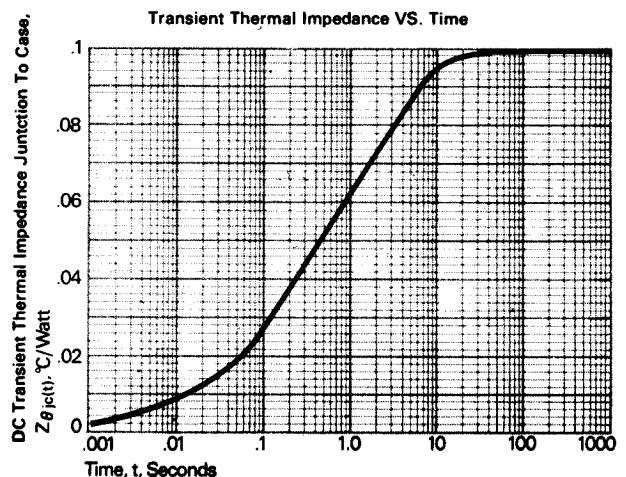
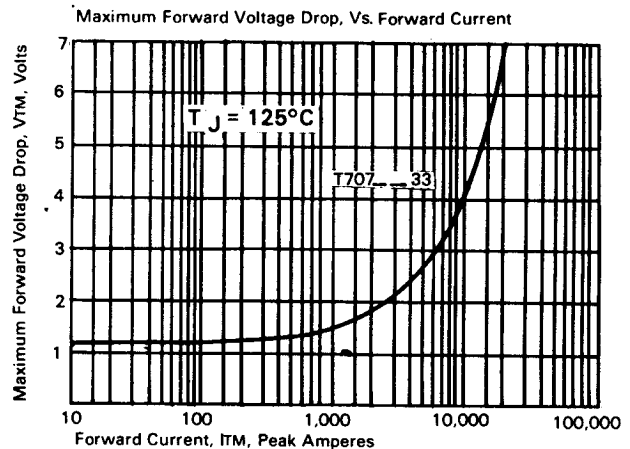

Fast Switching SCR T707_33

325A Avg.
(500 RMS)
Up to 800 Volts
10-50 μ s

Sinusoidal Current Data

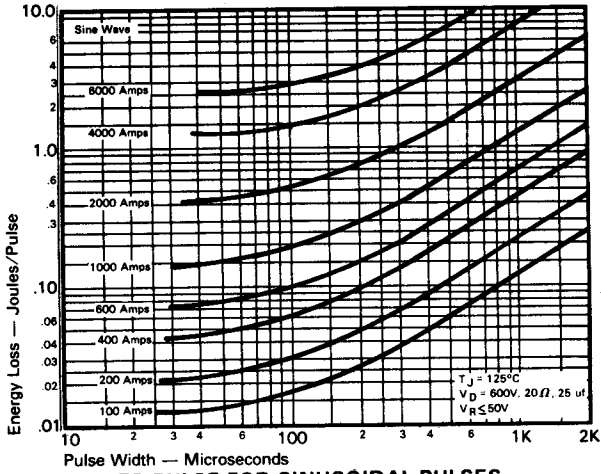

ENERGY PER PULSE FOR SINUSOIDAL PULSES

Trapezoidal Wave Current Data

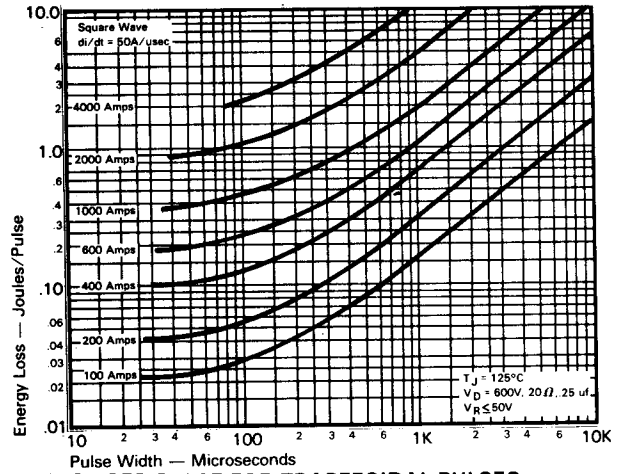

ENERGY PER PULSE FOR TRAPEZOIDAL PULSES
($di/dt = 50\text{A}/\mu\text{sec}$)

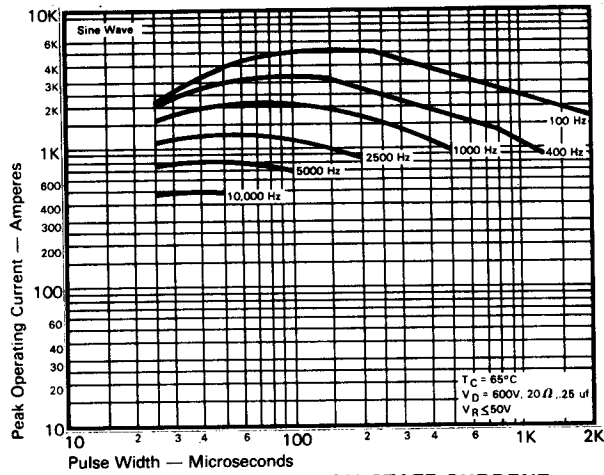

MAXIMUM ALLOWABLE PEAK ON-STATE CURRENT
vs. PULSE WIDTH ($T_C = 65^\circ\text{C}$)

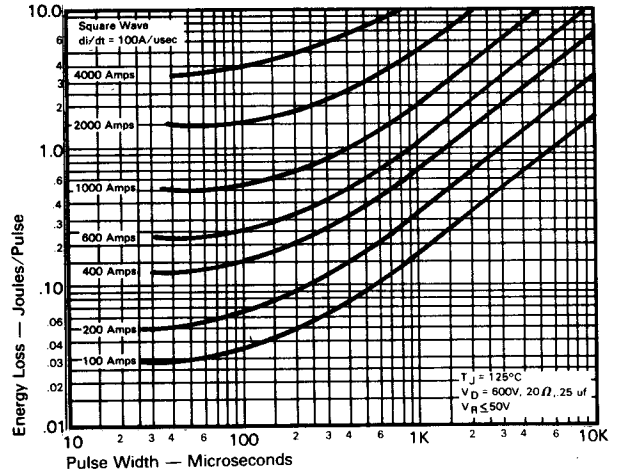

ENERGY PER PULSE FOR TRAPEZOIDAL PULSES
($di/dt = 100\text{A}/\mu\text{sec}$)

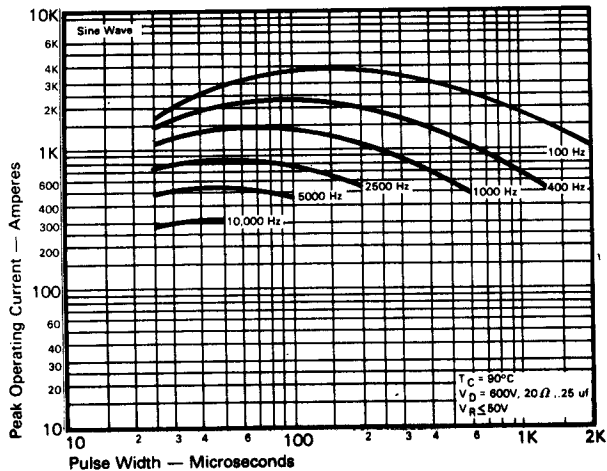

MAXIMUM ALLOWABLE PEAK ON-STATE CURRENT
vs. PULSE WIDTH ($T_C = 90^\circ\text{C}$)

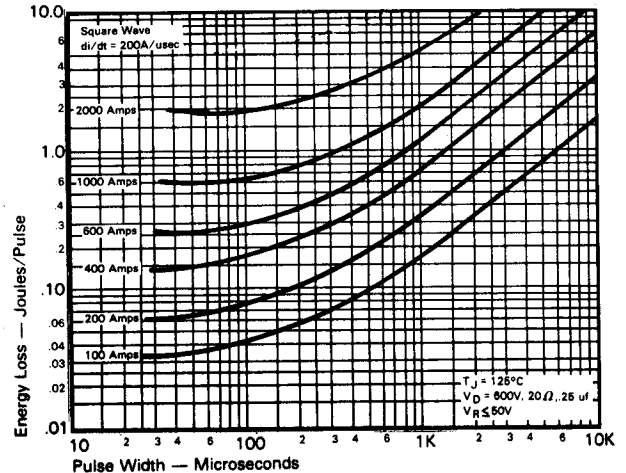

ENERGY PER PULSE FOR TRAPEZOIDAL PULSES
($di/dt = 200\text{A}/\mu\text{sec}$)

325A Avg.
(500 RMS)
Up to 800 Volts
10-50 μ s

Fast Switching
SCR
T707_33

Trapezoidal Wave Current Data
($T_C = 65^\circ\text{C}$)

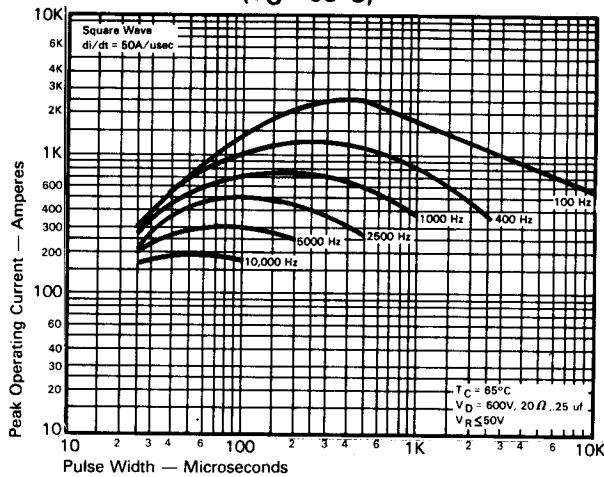

MAXIMUM ALLOWABLE PEAK ON-STATE CURRENT vs. PULSE WIDTH ($di/dt = 50\text{A}/\mu\text{sec}$)

Trapezoidal Wave Current Data
($T_C = 90^\circ\text{C}$)

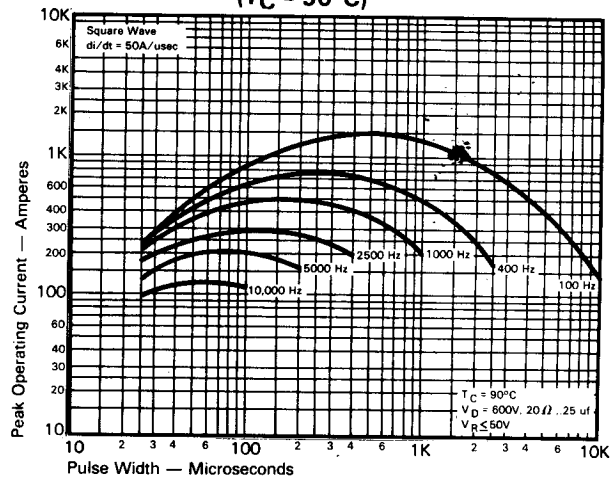

MAXIMUM ALLOWABLE PEAK ON-STATE CURRENT vs. PULSE WIDTH ($di/dt = 50\text{A}/\mu\text{sec}$)

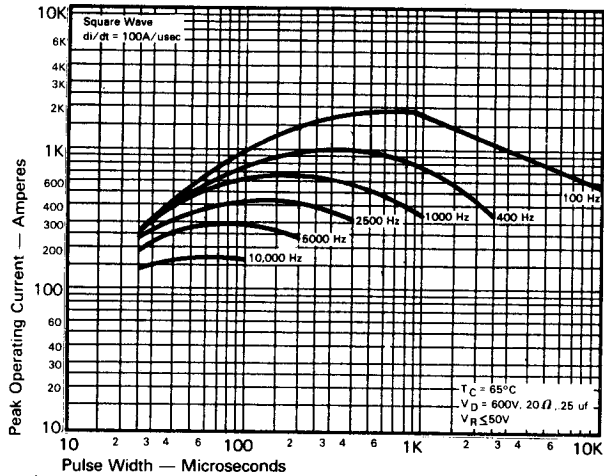

MAXIMUM ALLOWABLE PEAK ON-STATE CURRENT vs. PULSE WIDTH ($di/dt = 100\text{A}/\mu\text{sec}$)

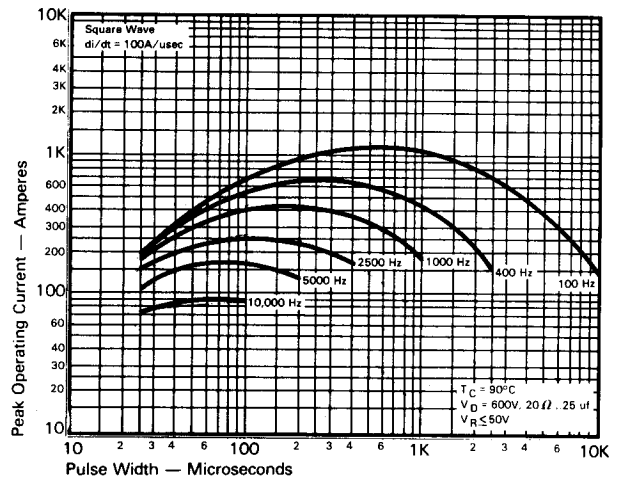

MAXIMUM ALLOWABLE PEAK ON-STATE CURRENT vs. PULSE WIDTH ($di/dt = 100\text{A}/\mu\text{sec}$)

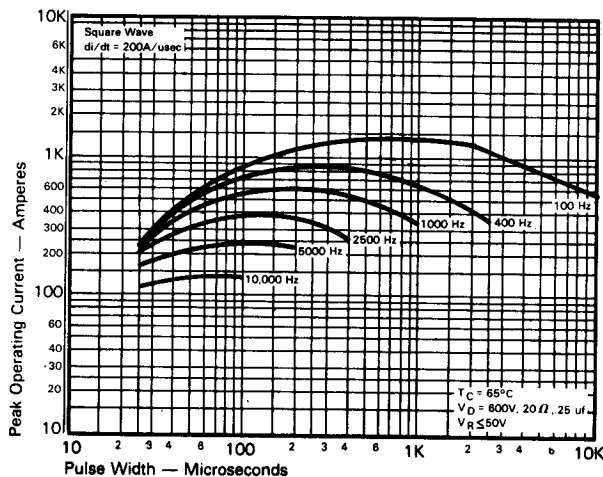

MAXIMUM ALLOWABLE PEAK ON-STATE CURRENT vs. PULSE WIDTH ($di/dt = 200\text{A}/\mu\text{sec}$)

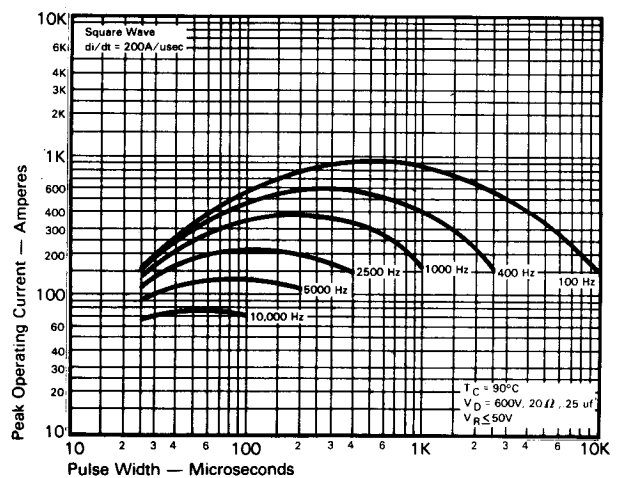

MAXIMUM ALLOWABLE PEAK ON-STATE CURRENT vs. PULSE WIDTH ($di/dt = 200\text{A}/\mu\text{sec}$)

FAST SWITCHING
THYRISTORS

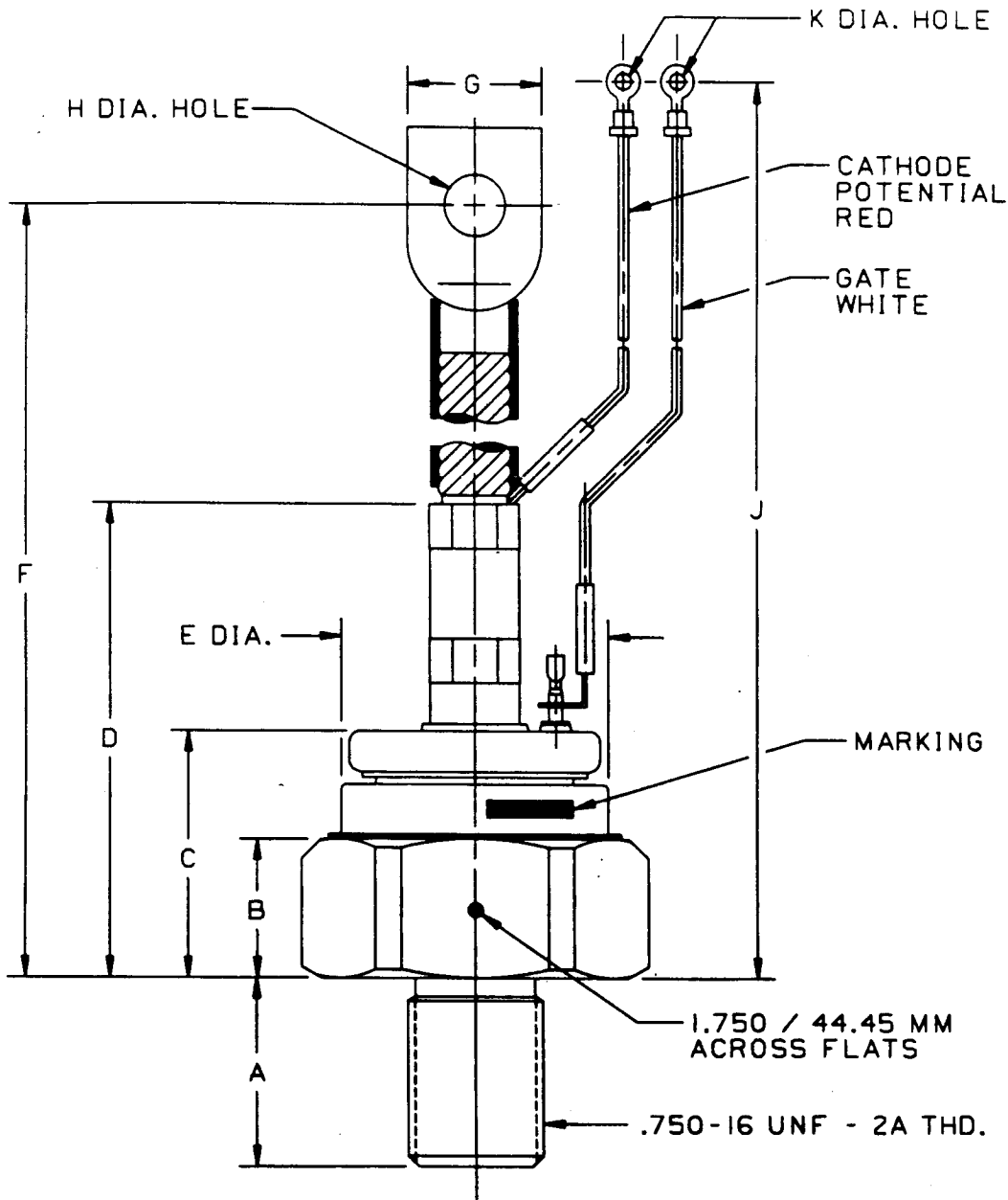

CASE NUMBER T70
 NOMINAL DIMENSIONS

STRIKE DISTANCE = .43 INCH / 10.9 MM MIN.
 CREEPAGE DISTANCE = .43 INCH / 10.9 MM MIN.

SYM.	A	B	C	D	E	F	G	H	J	K
INCHES	1.06	.78	1.41	2.74	1.49	9.66	.73	.343	10.06	.146
MM	26.9	19.8	35.8	69.6	37.8	245.4	18.5	8.71	255.5	3.71

ALL DIMENSIONS ARE REFERENCE