

Circuit Breaker for Equipment thermal, Rotary knob actuation, 2 pole



Thermal circuit breaker  
 Rotary Switch, 2-pole  
 Standard version

See below:

**Approvals and Compliances**

**Description**

- Thermal circuit breaker ,
- 2-pole
- Supplementary protector for general industrial use
- Positively trip-free release
- Method of operation acc. to IEC: S-type
- Bezel / knob snap-on

**Unique Selling Proposition**

- Easy actuation with gloves

**Applications**

- Power tools
- Industrial appliances
- Equipment for construction
- Cleaning equipment
- Commercial and household kitchen appliances

**References**

Available without bezel/knob for customized front panel design

**Weblinks**

[pdf data sheet](#), [html datasheet](#), [General Product Information](#), [Distributor-Stock-Check](#), [Detailed request for product](#), [Product News](#)

**Technical Data**

Rated Voltage AC	IEC: 240 VAC UL/CSA : 277 VAC	Overload	IEC: min. 40trips@ 6 x I <sub>r</sub> , cos φ 0.6 : min. 50trips@ 1.5 x I <sub>r</sub> , cos φ 0.75
Rated Voltage DC	60 VDC	Allowable Operation Temp.	-30°C to 60°C
Rated current range AC	0.05 - 20 A	Storage Temperature	-40°C to 60°C
Conditional short circuit capacity Inc	IEC 60934: 0.05...20 A: 2 kA, SC (C1) @ 240 VAC	Vibration Resistance	± 0.75 mm @ 10 - 60 Hz acc. to IEC 60068-2-6, test Tc 10 G @ 60 - 500 Hz acc. to IEC 60068-2-6, test Tc
Degree of Protection	front side IP40 acc. to IEC 60529	Shock Resistance	30 G / 18ms acc. to IEC 60068-2-27, test Ea
Dielectric Strength	50Hz: > 2.5kV Impulse 1.2/50 μs: > 4kV	Tripping Type	Thermal
Insulation Resistance	500VDC > 100 MΩ	Actuation Type	Rotary Knob
Lifetime	mechanical 50'000 switching cycles AC: 1 x I <sub>r</sub> , cos φ 0.6: 50'000 switching cycles DC: 1 x I <sub>r</sub> ,: 50'000 switching cycles	Weight	60 g

**Approvals and Compliances**

Detailed information on product approvals, code requirements, usage instructions and detailed test conditions can be looked up in [Details about Approvals](#)

SCHURTER products are designed for use in industrial environments. They have approvals from independent testing bodies according to national and international standards. Products with specific characteristics and requirements such as required in the automotive sector according to IATF 16949, medical technology according to ISO 13485 or in the aerospace industry can be offered exclusively with customer-specific, individual agreements by SCHURTER.

**Approvals**





The approval mark is used by the testing authorities to certify compliance with the safety requirements placed on electronic products.

Approval Reference Type: TA35

Approval Logo	Certificates	Certification Body	Description
	<a href="#">VDE Approvals</a>	VDE	VDE Certificate Number: 40019754
	<a href="#">UL Approvals</a>	UL	UR File Number: E71572
	<a href="#">CCC Approvals</a>	CCC	CCC Certificate Number: 2020970307001846





## Product standards

Product standards that are referenced

Organization	Design	Standard	Description
	Designed according to	IEC 60934	Circuit-breakers for equipment (CBE)
	Designed according to	UL 1077	Standard for Supplementary Protectors for Use in Electrical Equipment
	Designed according to	CSA C22.2 No. 235	Supplementary Protectors
	Designed according to	GB 17701	Circuit-breaker for equipment

## Compliances

The product complies with following Guide Lines

Identification	Details	Initiator	Description
	<a href="#">CE declaration of conformity</a>	SCHURTER AG	The CE marking declares that the product complies with the applicable requirements laid down in the harmonisation of Community legislation on its affixing in accordance with EU Regulation 765/2008.
	<a href="#">UKCA declaration of conformity</a>	SCHURTER AG	The UKCA marking declares that the product complies with the applicable requirements laid down in the British Amendment of Regulation (EC) 765/2008.
	RoHS	SCHURTER AG	Directive RoHS 2011/65/EU, Amendment (EU) 2015/863
	China RoHS	SCHURTER AG	The law SJ / T 11363-2006 (China RoHS) has been in force since 1 March 2007. It is similar to the EU directive RoHS.
	REACH	SCHURTER AG	On 1 June 2007, Regulation (EC) No 1907/2006 on the Registration, Evaluation, Authorization and Restriction of Chemicals 1 (abbreviated as "REACH") entered into force.

## Dimension [mm]

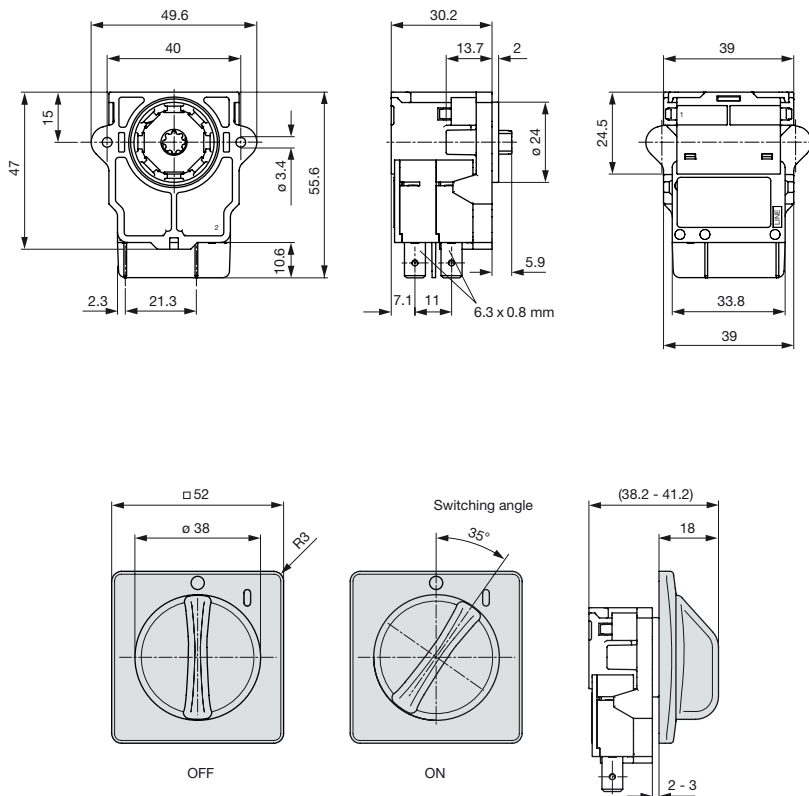



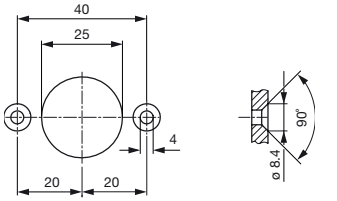

Cut out



Assembly Instructions



Approval		Rated current	Rated Voltage AC	Rated Voltage DC
 US	UL 1077	0.05...20 A	277 V	32/60 V
 US	CSA C22.2 235	0.05...20 A	277 V	32/60 V
	IEC 60934	0.05...20 A	240 V	32/60 V
	GB 17701	0.05...20 A	240 V	60 V

## Typical internal resistance per pole

Rated Current [A]	Internal Resistance [ $\Omega$ ]
0.05	200.000
0.1	70.000
0.5	2.750
1.0	0.720
1.5	0.340
2.0	0.187
2.5	0.115
2.8	0.089
3.0	0.059
4.0	0.059
5.0	0.044
6.0	0.028
7.0	0.0142
8.0	0.0142
10.0	0.0109
12.0	0.0086
13.0 *	0.0072
14.0 *	0.0072
15.0 *	0.0056
16.0 *	0.0056
18.0 *	0.0052
20.0 *	0.0052

\* 3-Pole max. 12 A

## Effect of ambient temperature

The units are calibrated for an ambient temperature of +23°C. To determine the rated current for a lower or higher ambient temperature, use a correction factor (typical value) from the table below:

Ambient Temperature [°C]	Correction factor
-30	0.76
-20	0.81
0	0.90
+23	1.00
+40	1.03
+50	1.04
+60	1.06

Example: Rated current = 5 A, Environmental temperature = 50 °C --> Correction factor = 1.04, Resulting current = 5.2 A --> Round to next higher rated current: 6 A

Time-Current-Curves

Tripping Characteristics  $I_n < 3\text{ A}$

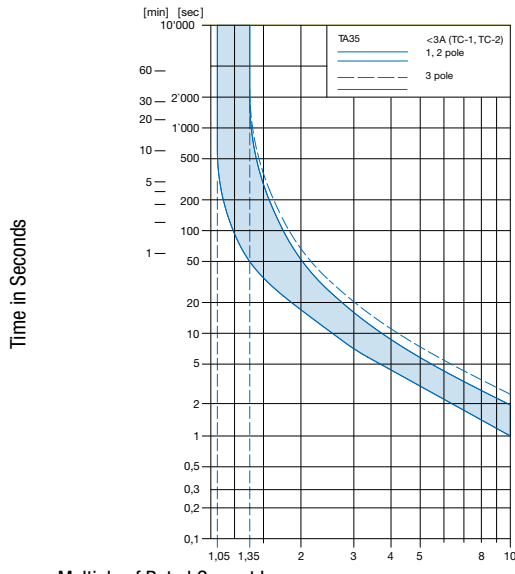

Multiple of Rated Current  $I_n$

Ambient temperature  $+23^\circ$

Tripping Characteristics  $I_n 3 - 20\text{ A}$

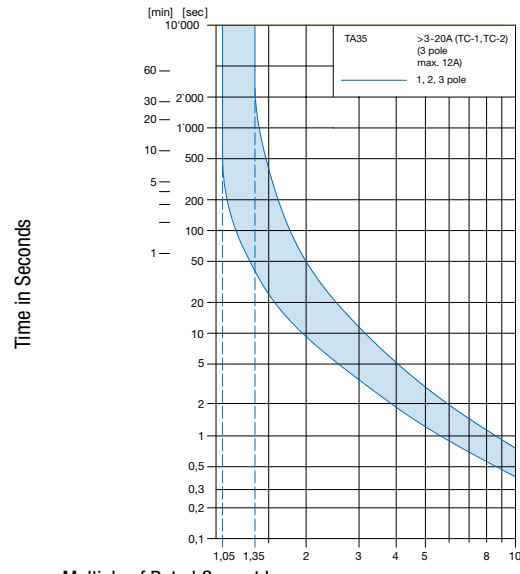

Multiple of Rated Current  $I_n$

Ambient temperature  $+23^\circ$

T	A	3	5	-	E	B	T	T	F	1	2	0	C	0	-	0	0	0
								1	2	3	4		5					
													6					

Basic function		1			
Poles		1	2		3
Thermal overload protection					
Illumination					
Rotary Knob					
Without illumination		EFT	EBT	EBD	EKD

Front- & Actuation color		2	
Front Bezel	Rotary Knob		
black	black	=	T
without bezel	without knob	=	N

Front bezel legend, marking		3	
Surface	Symbol		
relief recessed	I 0	=	F
no marking	no symbol	=	N

Rated current [A]		4			
Thermal overload protection					
In		In		In	
0.05 A	= Z05	1.0 A	= J10	4.0 A	= 040
0.10 A	= J01	1.2 A	= J12	5.0 A	= 050
0.20 A	= J02	1.5 A	= J15	6.0 A	= 060
0.30 A	= J03	2.0 A	= J20	7.0 A	= 070
0.40 A	= J04	2.5 A	= J25	8.0 A	= 080
0.50 A	= J05	3.0 A	= 030	10.0 A	= 100
0.80 A	= J08	3.5 A	= 035	12.0 A	= 120
				14.0 A*	= 140
				15.0 A*	= 150
				16.0 A*	= 160
				18.0 A*	= 180
				20.0 A*	= 200

\* 3-Pole max. 12 A

Features		5	
Standard/ no features		=	C0

Special marking		6	
Standard/ no special marking		=	000
Special marking (XXX = placeholder)		=	XXX

## All Variants

Designation	Order Number
TA35 Drehknopf 2Pol, 20 A, Snap-in version, Quick connect terminals 6.3 x 0.8 mm, 240 VAC, 2-pole, Circuit Breakers	4435.0074
TA35 Drehknopf 2Pol, 10 A, Snap-in version, Quick connect terminals 6.3 x 0.8 mm, 240 VAC, 2-pole, Circuit Breakers	4435.0086

Availability for all products can be searched real-time: <https://www.schurter.com/en/Stock-Check/Stock-Check-SCHURTER>