

High Power LED Series Chip Scale Package

LH181A

Use of Samsung's Chip Scale Package technology provide high performance and energy conserving



Features & Benefits

- Utilizes Samsung TF chip technology
- Suitable for use in indoor and outdoor lighting
- 70 CRI makes it well suited for most applications
- Operates at a maximum current of up to 1.5 A
- Compact footprint (1.9 x 1.9 mm)

Applications

- Indoor Lighting: Spotlight, Downlight, MR, PAR
- Outdoor Lighting: Street Light, Tunnel Light, Security Light, Parking Lot Light
- Industrial Lighting: High Bay Light, Low Bay Light
- Consumer Lighting: Torch Light

Table of Contents

1.	Characteristics	-----	3
2.	Product Code Information	-----	5
3.	Typical Characteristics Graphs	-----	14
4.	Outline Drawing & Dimension	-----	16
5.	Reliability Test Items & Conditions	-----	17
6.	Soldering Conditions	-----	18
7.	Tape & Reel	-----	19
8.	Label Structure	-----	21
9.	Packing Structure	-----	22
10.	Precautions in Handling & Use	-----	24

1. Characteristics

a) Absolute Maximum Rating

Item	Symbol	Rating	Unit	Condition
Ambient / Operating Temperature	T_a	-40 ~ +125	°C	Note 1)
Storage Temperature	T_{stg}	-40 ~ +125	°C	-
LED Junction Temperature	T_j	150	°C	-
Forward Current	I_F	1500	mA	-
Assembly Process Temperature	-	260 <10	°C s	-
ESD (HBM)	-	±2	kV	-

Note:

- 1) Refer to the derating curve, '3. Typical Characteristics Graph', for proper driving current that maintained below maximum junction temperature.

b) Electro-optical Characteristics

Item	Unit	Nominal CCT (K)	Condition		Value Typ.
			I _F (mA)	T _J (°C)	
Luminous Flux (Φ _v)	lm	5000 (70 CRI)	350	25	172
			350	85	160
			700	85	290
			1000	85	383
			1500	85	489
Forward Voltage (V _F)	V		350	25	2.92
			350	85	2.82
			700	85	2.97
			1000	85	3.08
			1500	85	3.15
Thermal Resistance (junction to solder point)	°C/W				3
Beam Angle	°				140

Note:

Samsung maintains measurement tolerance of: luminous flux = ±7%, forward voltage = ±0.1 V

2. Product Code Information

1	2	3	4	5	6	7	8	9	10	11	12	13	14	15	16	17	18
S	C	P	7	R	T	F	1	H	P	L	1	R	T	M	3	4	C

Digit	PKG Information	Code	Specification
1 2 3	Samsung Chip Scale Package	SCP	
4	CRI	7 Min. 70 E Min. 75 8 Min. 80 9 Min. 90	
5	CCT	W 2700K V 3000K U 3500K T 4000K R 5000K Q 5700K P 6500K	
6	Chip Shape	T	Square type
7 8 9	Product	F1H	Chip version
10 11 12	Product Purpose	PL1	PoC for lighting
13 14	CCT (K)	W0 2700 V0 3000 U0 3500 T0 4000 RT 5000 QT 5700 PT 6500	W1, W2, W3, W4, W5, W6, W7, W8, W9, WA, WB, WC, WD, WE, WF, WG V1, V2, V3, V4, V5, V6, V7, V8, V9, VA, VB, VC, VD, VE, VF, VG U1, U2, U3, U4, U5, U6, U7, U8, U9, UA, UB, UC, UD, UE, UF, UG Bin Code: T1, T2, T3, T4, T5, T6, T7, T8, T9, TA, TB, TC, TD, TE, TF, TG R1, R2, R3, R4 Q1, Q2, Q3, Q4 P1, P2, P3, P4
15 16	Luminous Flux	F3 90~120 G3 100~130 H3 110~140 J3 120~150 K3 130~160 M3 140~170 N3 150~180 P3 160~190	F1 90~100 G1 100~110 H1 110~120 J1 120~130 K1 130~140 M1 140~150 N1 150~160 P1 160~170
			Digit 15: Min. spec Digit 16: The number of higher bin(s) from min. spec. e.g.: K1 = 130~140 lm, K3 = 130~160 lm
17 18	Forward Voltage (Vf)	4C	2.6 ~ 3.0 V

a) Luminous Flux Bins and Characteristics ($I_F = 350 \text{ mA}$, $T_s = 85^\circ\text{C}$)

CRI (R_a) Min. ¹⁾	Nominal CCT (K)	Product Code	Sorting @ 150 mA (lm)		Calculated Minimum Flux ²⁾ (lm)	
			Flux Rank	Flux Range ¹⁾	@ 700 mA	@ 1000 mA
70	2700**	<i>SCP7WTF1HPL1W0J34C</i>	M1	140 ~ 150	257	339
			K1	130 ~ 140	238	315
			J1	120 ~ 130	220	291
	3000	<i>SCP7VTF1HPL1V0K34C</i>	N1	150 ~ 160	275	363
			M1	140 ~ 150	257	339
			K1	130 ~ 140	238	315
	3500**	<i>SCP7UTF1HPL1U0K34C</i>	N1	150 ~ 160	275	363
			M1	140 ~ 150	257	339
			K1	130 ~ 140	238	315
	4000	<i>SCP7TTF1HPL1T0M34C</i>	P1	160 ~ 170	293	388
			N1	150 ~ 160	275	363
			M1	140 ~ 150	257	339
	5000	<i>SCP7RTF1HPL1RTM34C</i>	P1	160 ~ 170	293	388
			N1	150 ~ 160	275	363
			M1	140 ~ 150	257	339
	5700	<i>SCP7QTF1HPL1QTM34C</i>	P1	160 ~ 170	293	388
			N1	150 ~ 160	275	363
			M1	140 ~ 150	257	339
6500**	<i>SCP7PTF1HPL1PTM34C</i>	P1	160 ~ 170	293	388	
		N1	150 ~ 160	275	363	
		M1	140 ~ 150	257	339	

Notes:

1) Samsung maintains measurement tolerance of: luminous flux = $\pm 7\%$, CRI = ± 3

2) Calculated minimum and maximum flux values are for reference only

**) Under development

a) Luminous Flux Bins and Characteristics ($I_F = 350 \text{ mA}$, $T_s = 85^\circ\text{C}$)

CRI (R_a) Min. ¹⁾	Nominal CCT (K)	Product Code	Sorting @ 150 mA (lm)		Calculated Minimum Flux ²⁾ (lm)	
			Flux Rank	Flux Range ¹⁾	@ 700 mA	@ 1000 mA
75	5000**	<i>SCP8VTF1HPL1V0K34C</i>	N1	150 ~ 160	275	363
			M1	140 ~ 150	257	339
			K1	130 ~ 140	238	315
	5700**	<i>SCPEQTF1HPL1QTK34C</i>	N1	150 ~ 160	275	363
			M1	140 ~ 150	257	339
			K1	130 ~ 140	238	315
80	2700**	<i>SCP8WTF1HPL1W0J34C</i>	M1	140 ~ 150	257	339
			K1	130 ~ 140	238	315
			J1	120 ~ 130	220	291
	3000	<i>SCP8VTF1HPL1V0K34C</i>	N1	150 ~ 160	275	363
			M1	140 ~ 150	257	339
			K1	130 ~ 140	238	315
	3500**	<i>SCP8VTF1HPL1V0K34C</i>	N1	150 ~ 160	275	363
			M1	140 ~ 150	257	339
			K1	130 ~ 140	238	315
	4000	<i>SCP8TTF1HPL1T0K34C</i>	N1	150 ~ 160	275	363
			M1	140 ~ 150	257	339
			K1	130 ~ 140	238	315
5000**	<i>SCP8RTF1HPL1RTK34C</i>	N1	150 ~ 160	275	363	
		M1	140 ~ 150	257	339	
		K1	130 ~ 140	238	315	

Notes:

1) Samsung maintains measurement tolerance of: luminous flux = $\pm 7\%$, CRI = ± 3

2) Calculated minimum and maximum flux values are for reference only

**) Under development

b) Color Bins ($I_F = 350 \text{ mA}$, $T_s = 85 \text{ }^\circ\text{C}$)

CRI (R_a) Min.	Nominal CCT (K)	Product Code	Color Rank	Chromaticity Bins
70	2700**	SCP7WTF1HPL1W0J34C	W0 (Whole bin)	V1, V2, V3, V4, V5, V6, V7, V8, V9, VA, VB, VC, VD, VE, VF, VG
	3000	SCP7VTF1HPL1V0K34C	V0 (Whole bin)	V1, V2, V3, V4, V5, V6, V7, V8, V9, VA, VB, VC, VD, VE, VF, VG
	3500**	SCP7UTF1HPL1U0K34C	U0 (Whole bin)	U1, U2, U3, U4, U5, U6, U7, U8, U9, UA, UB, UC, UD, UE, UF, UG
	4000	SCP7TTF1HPL1T0M34C	T0 (Whole bin)	T1, T2, T3, T4, T5, T6, T7, T8, T9, TA, TB, TC, TD, TE, TF, TG
	5000	SCP7RTF1HPL1RTM34C	RT (ANSI bin)	R1, R2, R3, R4
	5700	SCP7QTF1HPL1QTM34C	QT (ANSI bin)	Q1, Q2, Q3, Q4
	6500**	SCP7PTF1HPL1PTM34C	PT (ANSI bin)	P1, P2, P3, P4
75	5000**	SCP8RTF1HPL1RTK34C	RT (ANSI bin)	R1, R2, R3, R4
	5700**	SCP8QTF1HPL1QTK34C	QT (ANSI bin)	Q1, Q2, Q3, Q4
80	2700**	SCP8WTF1HPL1W0J34C	W0 (Whole bin)	W1, W2, W3, W4, W5, W6, W7, W8, W9, WA, WB, WC, WD, WE, WF, WG
	3000	SCP8VTF1HPL1V0K34C	V0 (Whole bin)	V1, V2, V3, V4, V5, V6, V7, V8, V9, VA, VB, VC, VD, VE, VF, VG
	3500**	SCP8UTF1HPL1U0K34C	U0 (Whole bin)	U1, U2, U3, U4, U5, U6, U7, U8, U9, UA, UB, UC, UD, UE, UF, UG
	4000	SCP8TTF1HPL1T0K34C	T0 (Whole bin)	T1, T2, T3, T4, T5, T6, T7, T8, T9, TA, TB, TC, TD, TE, TF, TG
	5000**	SCP8RTF1HPL1RTK34C	RT (ANSI bin)	R1, R2, R3, R4

**) Under development

c) Voltage Bins ($I_f = 350 \text{ mA}$, $T_s = 85 \text{ }^\circ\text{C}$)

CRI (R_a) Min.	Nominal CCT (K)	Product Code	Voltage Rank	Voltage Bin	Voltage Range (V)
				4C	2.6 ~ 3.0

d) Chromaticity Region & Coordinates ($I_f = 350 \text{ mA}$, $T_s = 85^\circ \text{C}$)

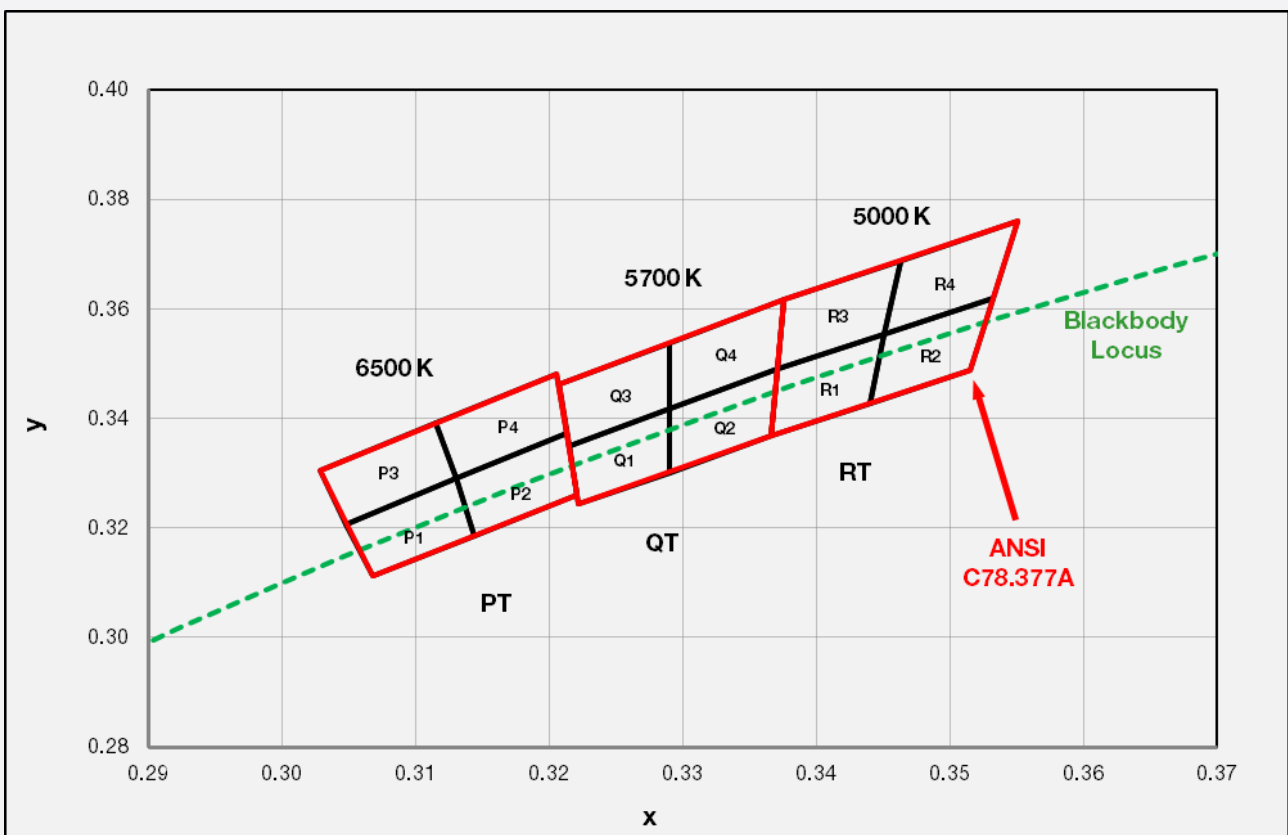
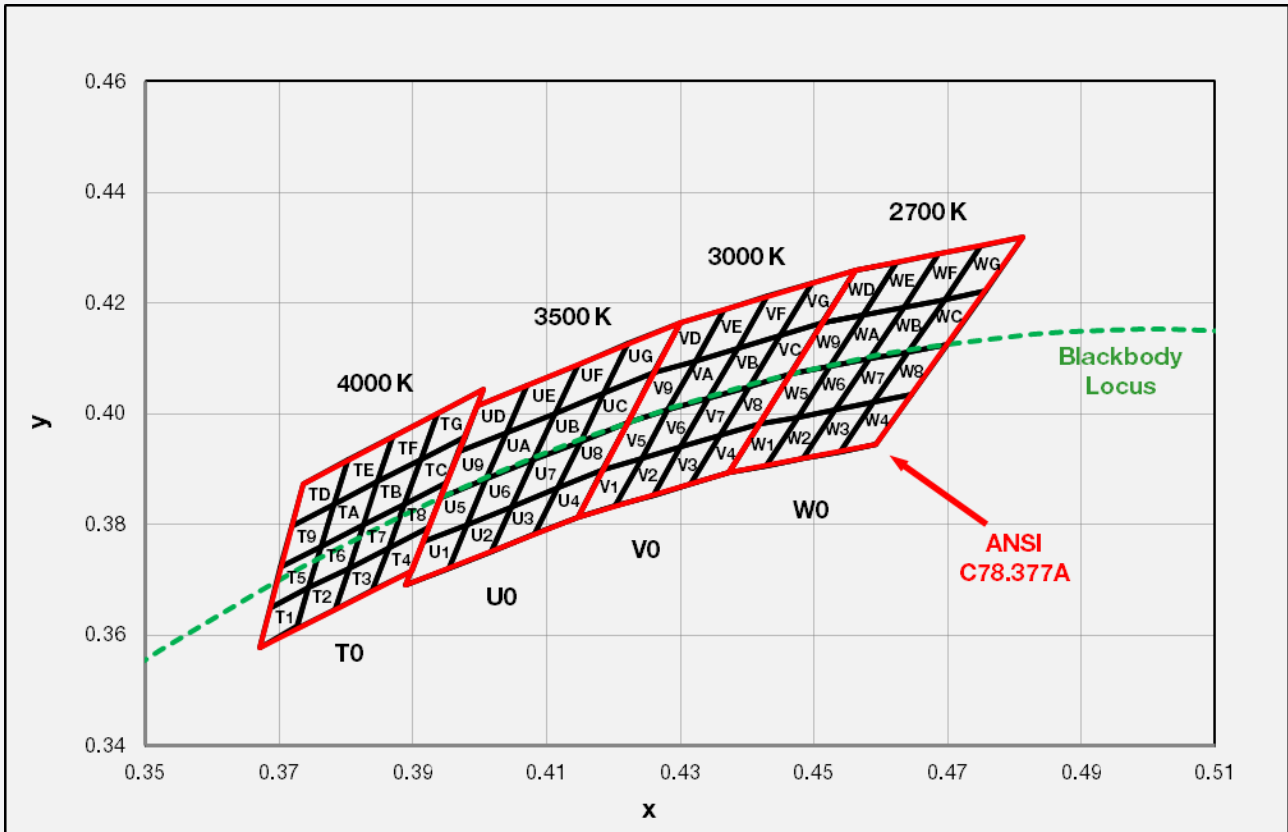

d) Chromaticity Region & Coordinates ($I_F = 350 \text{ mA}$, $T_s = 85 \text{ }^\circ\text{C}$)

Region	CIE x	CIE y	Region	CIE x	CIE y
W rank (2700 K)					
W1	0.4373	0.3893	W9	0.4465	0.4071
	0.4418	0.3981		0.4513	0.4164
	0.4475	0.3994		0.4573	0.4178
	0.4428	0.3906		0.4523	0.4085
W2	0.4428	0.3906	WA	0.4523	0.4085
	0.4475	0.3994		0.4573	0.4178
	0.4532	0.4008		0.4634	0.4193
	0.4483	0.3919		0.4582	0.4099
W3	0.4483	0.3919	WB	0.4582	0.4099
	0.4532	0.4008		0.4634	0.4193
	0.4589	0.4021		0.4695	0.4207
	0.4538	0.3931		0.4641	0.4112
W4	0.4538	0.3931	WC	0.4641	0.4112
	0.4589	0.4021		0.4695	0.4207
	0.4646	0.4034		0.4756	0.4221
	0.4593	0.3944		0.4700	0.4126
W5	0.4418	0.3981	WD	0.4513	0.4164
	0.4465	0.4071		0.4562	0.4260
	0.4523	0.4085		0.4624	0.4274
	0.4475	0.3994		0.4573	0.4178
W6	0.4475	0.3994	WE	0.4573	0.4178
	0.4523	0.4085		0.4624	0.4274
	0.4582	0.4099		0.4687	0.4289
	0.4532	0.4008		0.4634	0.4193
W7	0.4532	0.4008	WF	0.4634	0.4193
	0.4582	0.4099		0.4687	0.4289
	0.4641	0.4112		0.4750	0.4304
	0.4589	0.4021		0.4695	0.4207
W8	0.4589	0.4021	WG	0.4695	0.4207
	0.4641	0.4112		0.4750	0.4304
	0.4700	0.4126		0.4813	0.4319
	0.4646	0.4034		0.4756	0.4221

Region	CIE x	CIE y	Region	CIE x	CIE y
V rank (3000 K)					
V1	0.4147	0.3814	V9	0.4221	0.3984
	0.4183	0.3898		0.4259	0.4073
	0.4242	0.3919		0.4322	0.4096
	0.4203	0.3833		0.4281	0.4006
V2	0.4203	0.3833	VA	0.4281	0.4006
	0.4242	0.3919		0.4322	0.4096
	0.4300	0.3939		0.4385	0.4119
	0.4259	0.3853		0.4342	0.4028
V3	0.4259	0.3853	VB	0.4342	0.4028
	0.4300	0.3939		0.4385	0.4119
	0.4359	0.3960		0.4449	0.4141
	0.4316	0.3873		0.4403	0.4049
V4	0.4316	0.3873	VC	0.4403	0.4049
	0.4359	0.3960		0.4449	0.4141
	0.4418	0.3981		0.4513	0.4164
	0.4373	0.3893		0.4465	0.4071
V5	0.4183	0.3898	VD	0.4259	0.4073
	0.4221	0.3984		0.4299	0.4165
	0.4281	0.4006		0.4364	0.4188
	0.4242	0.3919		0.4322	0.4096
V6	0.4242	0.3919	VE	0.4322	0.4096
	0.4281	0.4006		0.4364	0.4188
	0.4342	0.4028		0.4430	0.4212
	0.4300	0.3939		0.4385	0.4119
V7	0.4300	0.3939	VF	0.4385	0.4119
	0.4342	0.4028		0.4430	0.4212
	0.4403	0.4049		0.4496	0.4236
	0.4359	0.3960		0.4449	0.4141
V8	0.4359	0.3960	VG	0.4449	0.4141
	0.4403	0.4049		0.4496	0.4236
	0.4465	0.4071		0.4562	0.4260
	0.4418	0.3981		0.4513	0.4164

d) Chromaticity Region & Coordinates

Region	CIE x	CIE y	Region	CIE x	CIE y
U rank (3500 K)					
U1	0.3889	0.3690	U9	0.3941	0.3848
	0.3915	0.3768		0.3968	0.3930
	0.3981	0.3800		0.4040	0.3966
	0.3953	0.3720		0.4010	0.3882
U2	0.3953	0.3720	UA	0.4010	0.3882
	0.3981	0.3800		0.4040	0.3966
	0.4048	0.3832		0.4113	0.4001
	0.4017	0.3751		0.4080	0.3916
U3	0.4017	0.3751	UB	0.4080	0.3916
	0.4048	0.3832		0.4113	0.4001
	0.4116	0.3865		0.4186	0.4037
	0.4082	0.3782		0.4150	0.3950
U4	0.4082	0.3782	UC	0.4150	0.3950
	0.4116	0.3865		0.4186	0.4037
	0.4183	0.3898		0.4259	0.4073
	0.4147	0.3814		0.4221	0.3984
U5	0.3915	0.3768	UD	0.3968	0.3930
	0.3941	0.3848		0.3996	0.4015
	0.4010	0.3882		0.4071	0.4052
	0.3981	0.3800		0.4040	0.3966
U6	0.3981	0.3800	UE	0.4040	0.3966
	0.4010	0.3882		0.4071	0.4052
	0.4080	0.3916		0.4146	0.4089
	0.4048	0.3832		0.4113	0.4001
U7	0.4048	0.3832	UF	0.4113	0.4001
	0.4080	0.3916		0.4146	0.4089
	0.4150	0.3950		0.4222	0.4127
	0.4116	0.3865		0.4186	0.4037
U8	0.4116	0.3865	UG	0.4186	0.4037
	0.4150	0.3950		0.4222	0.4127
	0.4221	0.3984		0.4299	0.4165
	0.4183	0.3898		0.4259	0.4073

Region	CIE x	CIE y	Region	CIE x	CIE y
T rank (4000 K)					
T1	0.3670	0.3578	T9	0.3702	0.3722
	0.3726	0.3612		0.3763	0.3760
	0.3744	0.3685		0.3782	0.3837
	0.3686	0.3649		0.3719	0.3797
T2	0.3726	0.3612	TA	0.3763	0.3760
	0.3783	0.3646		0.3825	0.3798
	0.3804	0.3721		0.3847	0.3877
	0.3744	0.3685		0.3782	0.3837
T3	0.3783	0.3646	TB	0.3825	0.3798
	0.3840	0.3681		0.3887	0.3836
	0.3863	0.3758		0.3912	0.3917
	0.3804	0.3721		0.3847	0.3877
T4	0.3840	0.3681	TC	0.3887	0.3837
	0.3898	0.3716		0.3950	0.3875
	0.3924	0.3794		0.3978	0.3958
	0.3863	0.3758		0.3912	0.3917
T5	0.3686	0.3649	TD	0.3719	0.3797
	0.3744	0.3685		0.3782	0.3837
	0.3763	0.3760		0.3802	0.3916
	0.3702	0.3722		0.3736	0.3874
T6	0.3744	0.3685	TE	0.3782	0.3837
	0.3804	0.3721		0.3847	0.3877
	0.3825	0.3798		0.3869	0.3958
	0.3763	0.376		0.3802	0.3916
T7	0.3804	0.3721	TF	0.3847	0.3877
	0.3863	0.3758		0.3912	0.3917
	0.3887	0.3836		0.3937	0.4001
	0.3825	0.3798		0.3869	0.3958
T8	0.3863	0.3758	TG	0.3912	0.3917
	0.3924	0.3794		0.3978	0.3958
	0.3950	0.3875		0.4006	0.4044
	0.3887	0.3836		0.3937	0.4001

d) Chromaticity Region & Coordinates

Region	CIE x	CIE y	Region	CIE x	CIE y	Region	CIE x	CIE y
R rank (5000 K)			Q rank (5700 K)			P rank (6500 K)		
R1	0.3371	0.3490	Q1	0.3215	0.3350	P1	0.3068	0.3113
	0.3451	0.3554		0.3290	0.3417		0.3144	0.3186
	0.3440	0.3427		0.3290	0.3300		0.3130	0.3290
	0.3366	0.3369		0.3222	0.3243		0.3048	0.3207
R2	0.3451	0.3554	Q2	0.3290	0.3417	P2	0.3144	0.3186
	0.3533	0.3620		0.3371	0.3490		0.3221	0.3261
	0.3515	0.3487		0.3366	0.3369		0.3213	0.3373
	0.3440	0.3427		0.3290	0.3300		0.3130	0.3290
R3	0.3376	0.3616	Q3	0.3207	0.3462	P3	0.3048	0.3207
	0.3463	0.3687		0.3290	0.3538		0.3130	0.3290
	0.3451	0.3554		0.3290	0.3417		0.3115	0.3391
	0.3371	0.3490		0.3215	0.3350		0.3028	0.3304
R4	0.3463	0.3687	Q4	0.3290	0.3538	P4	0.3130	0.3290
	0.3551	0.3760		0.3376	0.3616		0.3213	0.3373
	0.3533	0.3620		0.3371	0.3490		0.3205	0.3481
	0.3451	0.3554		0.3290	0.3417		0.3115	0.3391

Note:

Samsung maintains measurement tolerance of: $C_x, C_y = \pm 0.005$

3. Typical Characteristics Graphs

a) Spectrum Distribution ($I_f = 350 \text{ mA}$, $T_s = 85 \text{ }^\circ\text{C}$)

Cool White

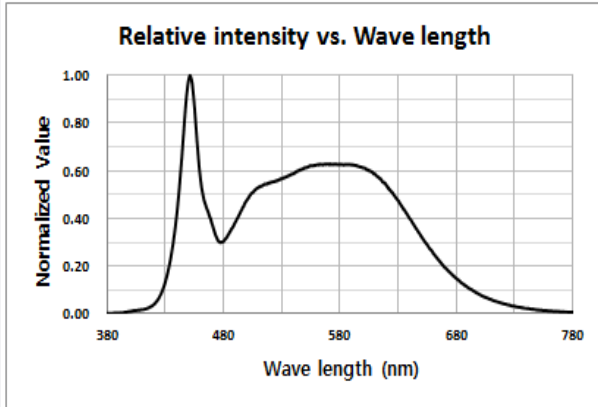

b) Forward Current Characteristics ($T_s = 85 \text{ }^\circ\text{C}$)

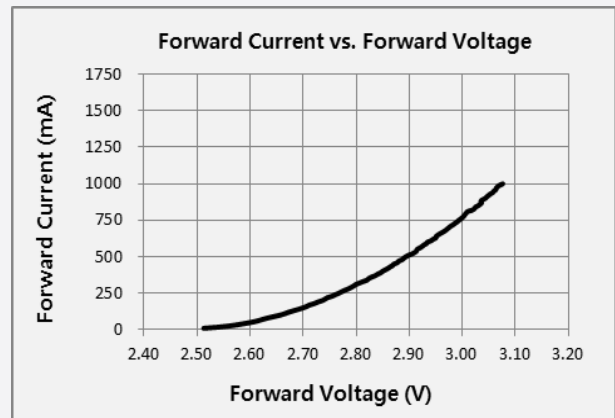
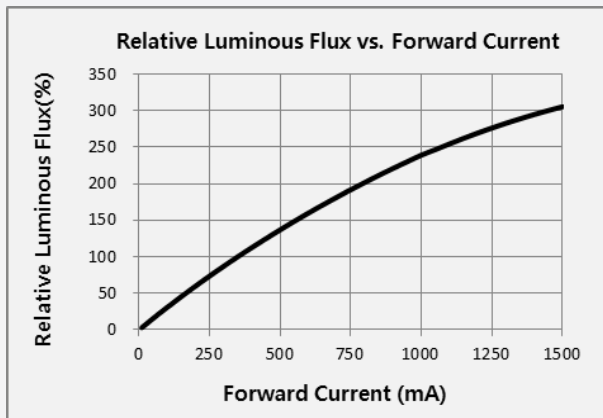

c) Temperature Characteristics ($I_f = 350 \text{ mA}$)

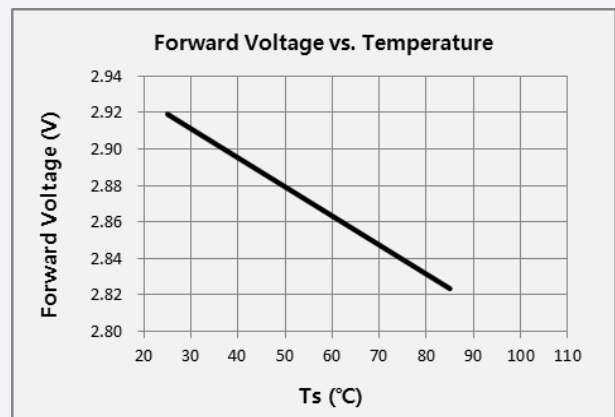
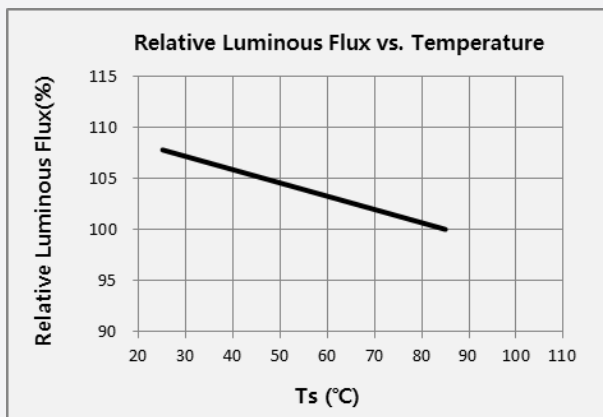

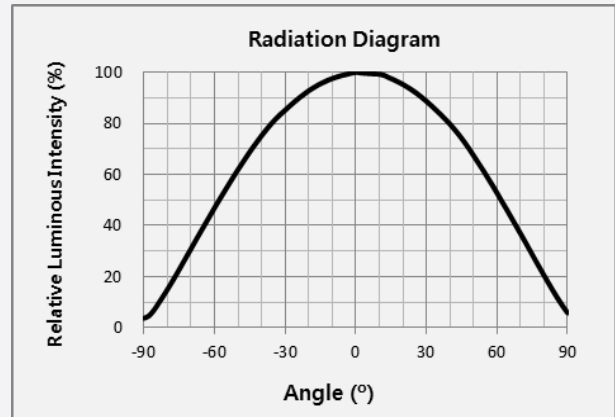
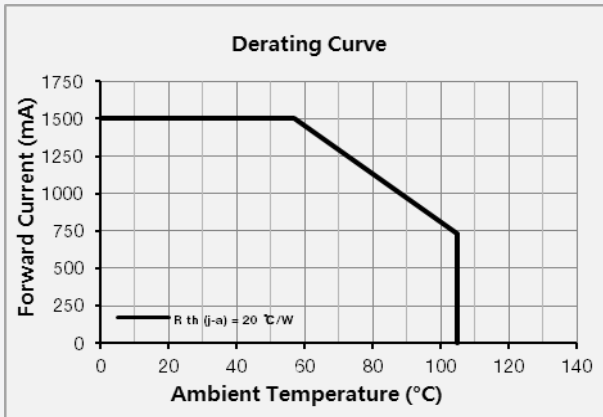
d) Derating Curve and Beam Angle Characteristics ($I_F = 350 \text{ mA}$, $T_s = 25^\circ\text{C}$)

4. Outline Drawing & Dimension

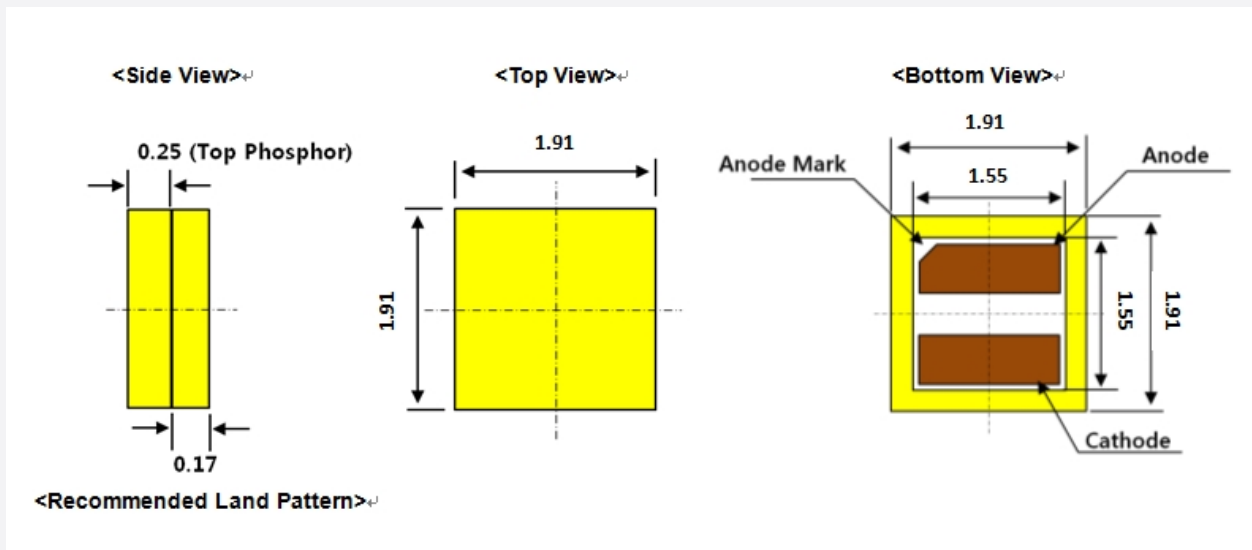

Precautions:

- 1) Pressure on the LEDs will influence to the reliability of the LEDs. Precautions should be taken to avoid strong pressure on the LEDs. Do not put stress on the LEDs during heating.
- 2) Re-soldering should not be done after the LEDs have been soldered. If re-soldering is unavoidable, LED's characteristics should be carefully checked before and after such repair.
- 3) Do not stack assembled PCBs together. Since materials of LEDs is soft, abrasion between two PCB assembled with LED might cause catastrophic failure of the LEDs.

5. Reliability Test Items & Conditions

a) Test Items

Test Item	Test Condition	Test Hour / Cycle	Sample Size
Room Temperature Life Test	25 °C, current on derating curve	1000 h	22
High Temperature Life Test	85 °C, current on derating curve	1000 h	22
High Temperature Humidity Life Test	85 °C, 85 % RH, current on derating curve	1000 h	22
Low Temperature Life Test	-40 °C, current on derating curve	1000 h	22
Temperature Humidity Cycle Test	-10 °C ↔ 25 °C 95 % RH ↔ 65 °C 95 % RH DC 1000 mA, 24 h / 1 cycle	10 cycles	11
Powered Temperature Cycle Test	-40 °C / 85 °C each 20 min, 100 min transfer power on/off each 5 min, current on derating curve	100 cycles	11
Thermal Shock	-45 °C / 15 min ↔ 125 °C / 15 min temperature change within 5 min	500 cycles	100
High Temperature Storage	120 °C	1000 h	11
Low Temperature Storage	-40 °C	1000 h	11
ESD (HBM)	<p> R₁: 10 MΩ R₂: 1.5 kΩ C: 100 pF V: ±2 kV </p>	5 times	30
ESD (MM)		R ₁ : 10 MΩ R ₂ : 0 C: 200 pF V: ±0.2 kV	5 times
Vibration Test	20~2000~20 Hz, 200 m/s ² , sweep 4 min X, Y, Z 3 direction, each 1 cycle	4 cycles	11
Mechanical Shock Test	1500 g, 0.5 ms 3 shocks each X-Y-Z axis	5 cycles	11

b) Criteria for Judging the Damage

Item	Symbol	Test Condition (T _j = 25 °C)	Limit	
			Min.	Max.
Forward Voltage	V _F	I _F = 350 mA	Init. Value * 0.9	Init. Value * 1.1
Luminous Flux	Φ _v	I _F = 350 mA	Init. Value * 0.7	Init. Value * 1.1

6. Soldering Conditions

a) Reflow Conditions (Pb free)

Reflow frequency: 2 times max.

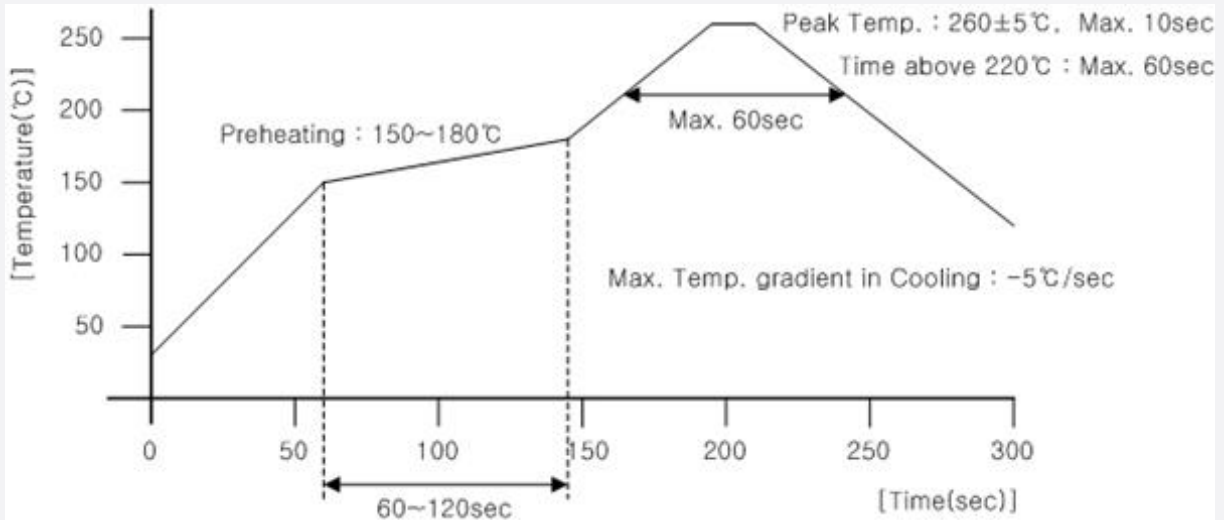

b) Manual Soldering Conditions

No more than 5 seconds @ max. 300 °C, under soldering iron.

7. Tape & Reel (TBD)

a) Taping Dimension (TBD)

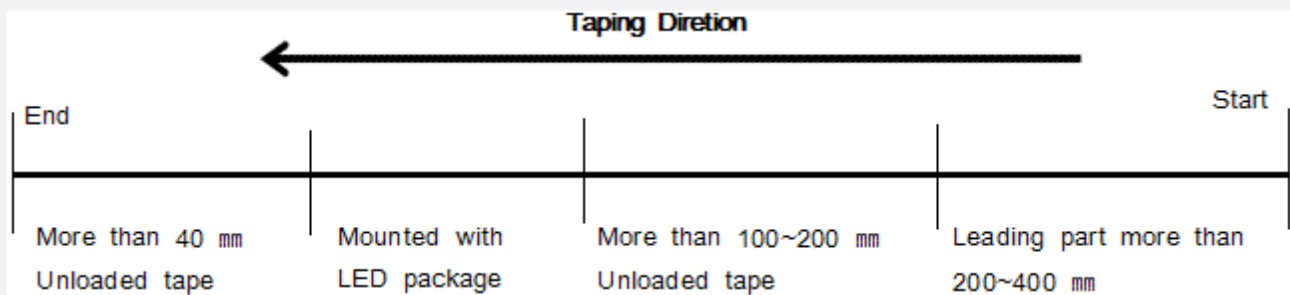
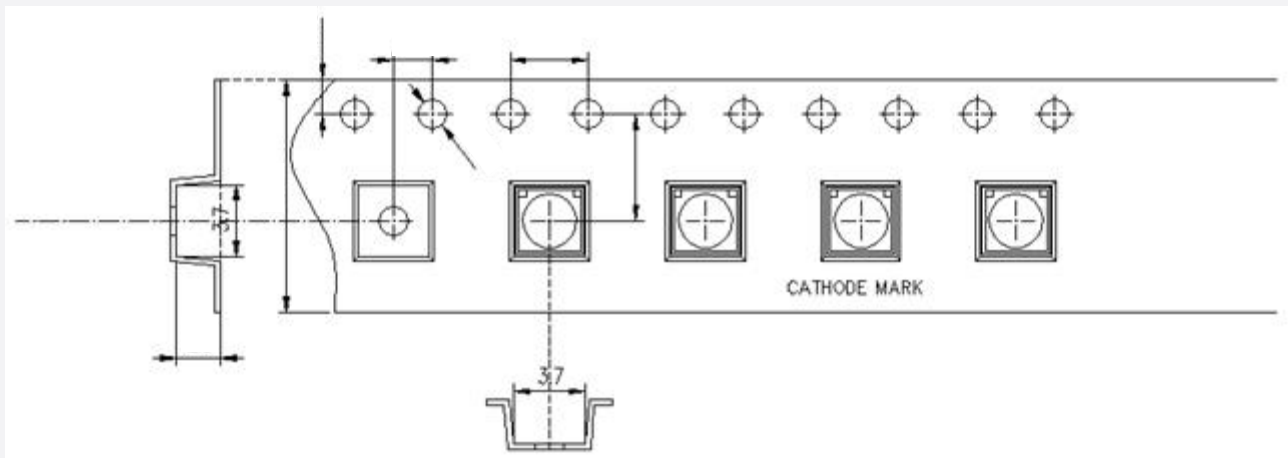

b) Reel Dimension (TBD)

(unit: mm)

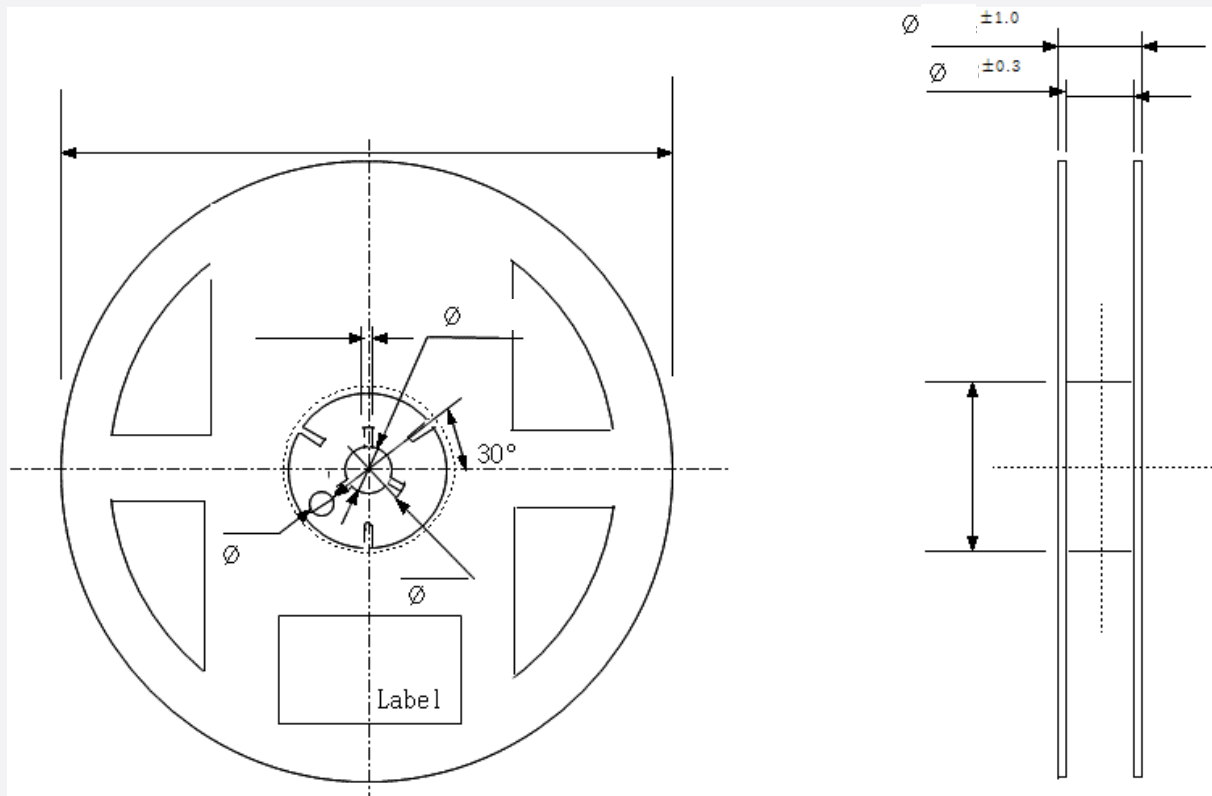
**Notes:**

- 1) Quantity: The quantity/reel is 4,000 pcs
- 2) Cumulative tolerance: Cumulative tolerance / 10 pitches is ± 0.2 mm
- 3) Adhesion strength of cover tape: Adhesion strength is 0.1-0.7 N when the cover tape is turned off from the carrier tape at 10° angle to the carrier tape
- 4) Packaging: P/N, Manufacturing data code no. and quantity are indicated on the aluminum packing bag

8. Label Structure (TBD)

a) Label Structure

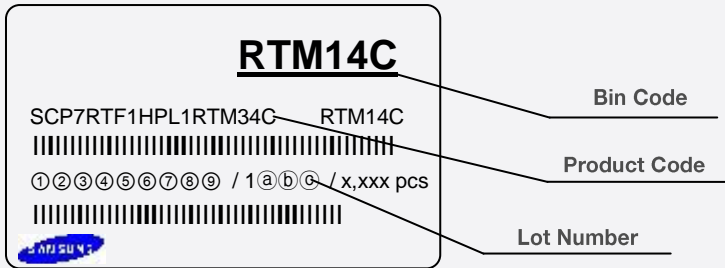

Note: Denoted bin code and product code above is only an example (see description on page -)

Bin Code:

- ⓐⓑ: Chromaticity bin (refer to page 8)
- ⓒⓓ: Luminous Flux bin (refer to page 6-7)
- ⓔⓕ: Voltage bin (refer to page 9)

b) Lot Number

The lot number is composed of the following characters:

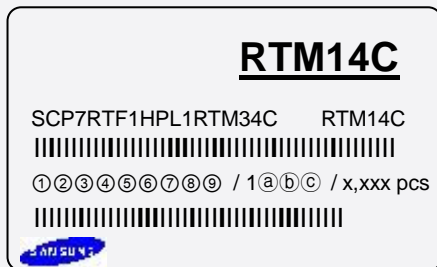

- ① : Production site (S: Giheung, Korea)
- ② : L (LED)
- ③ : Product state (A: Normal, S: Sample)
- ④ : Year (A: 2016, B:2017, C:2018...)
- ⑤ : Month (1~9, A, B, C)
- ⑥ : Day (1~9, A, B~V)
- ⑦⑧⑨ : Product serial number (001 ~ 999)

10. Precautions in Handling & Use

- 1) For over-current protection, users are recommended to apply resistors connected in series with the LEDs to mitigate sudden change of the forward current caused by shift of forward voltage.
- 2) This device should not be used in any type of fluid such as water, oil, organic solvent, etc. When cleaning is required, IPA is recommended as the cleaning agent. Some solvent-based cleaning agent may damage the silicone resins used in the device.
- 3) When the device is in operation, the forward current should be carefully determined considering the maximum ambient temperature and corresponding junction temperature.
- 4) LEDs must be stored in a clean environment. If the LEDs are to be stored for three months or more after being shipped from Samsung, they should be packed with a nitrogen-filled container (shelf life of sealed bags is 12 months at temperature 0~40 °C, 0~90 % RH).
- 5) After storage bag is opened, device subjected to soldering, solder reflow, or other high temperature processes must be:
 - a. Mounted within 672 hours (28 days) at an assembly line with a condition of no more than 30 °C / 60 % RH, or
 - b. Stored at <10 % RH
- 6) Repack unused devices with anti-moisture packing, fold to close any opening and then store in a dry place.
- 7) Devices require baking before mounting, if humidity card reading is >60 % at 23 ± 5 °C.
- 8) Devices must be baked for 1 hour at 60 ± 5 °C, if baking is required.
- 9) The LEDs are sensitive to the static electricity and surge current. It is recommended to use a wrist band or anti-electrostatic glove when handling the LEDs. If voltage exceeding the absolute maximum rating is applied to LEDs, it may cause damage or even destruction to LED devices. Damaged LEDs may show some unusual characteristics such as increase in leakage current, lowered turn-on voltage, or abnormal lighting of LEDs at low current.
- 10) VOCs (Volatile Organic Compounds) can be generated from adhesives, flux, hardener or organic additives used in luminaires (fixtures). Transparent LED silicone encapsulant is permeable to those chemicals and they may lead to a discoloration of encapsulant when they exposed to heat or light. This phenomenon can cause a significant loss of light emitted (output) from the luminaires. In order to prevent these problems, we recommend users to know the physical properties of materials used in luminaires and they must be carefully selected.

Legal and additional information.

[About Samsung Electronics Co., Ltd.](#)

Samsung Electronics Co., Ltd. is a global leader in technology, opening new possibilities for people everywhere. Through relentless innovation and discovery, we are transforming the worlds of TVs, smartphones, tablets, PCs, cameras, home appliances, printers, LTE systems, medical devices, semiconductors and LED solutions. We employ 286,000 people across 80 countries with annual sales of US\$216.7 billion. To discover more, please visit www.samsungled.com.

Copyright © 2016 Samsung Electronics Co., Ltd. All rights reserved.
Samsung is a registered trademark of Samsung Electronics Co., Ltd.
Specifications and designs are subject to change without notice. Non-metric weights and measurements are approximate. All data were deemed correct at time of creation. Samsung is not liable for errors or omissions. All brand, product, service names and logos are trademarks and/or registered trademarks of their respective owners and are hereby recognized and acknowledged.

Samsung Electronics Co., Ltd.
1, Samsung-ro
Giheung-gu
Yongin-si, Gyeonggi-do, 17113
KOREA

www.samsungled.com

