

<IGBT Modules>

CM600HA-24A

**HIGH POWER SWITCHING USE
INSULATED TYPE**



single switch

Collector current I_C **600 A**
 Collector-emitter voltage V_{CES} **1200 V**
 Maximum junction temperature T_{jmax} **150 °C**

- Flatbase type
- Copper base plate (non-plating)
- Main terminal screws are not attached.
- RoHS Directive compliant
- Recognized under UL1557, File E323585

APPLICATION

AC Motor Control, Motion/Servo Control, Power supply, etc.

OUTLINE DRAWING & INTERNAL CONNECTION

Dimension in mm

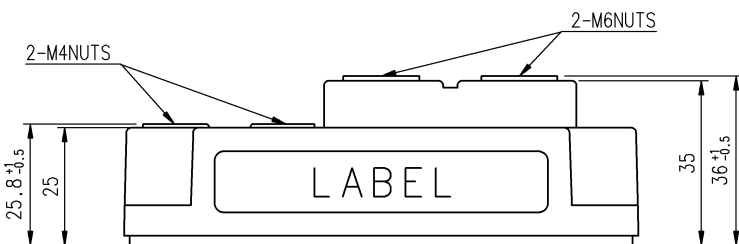
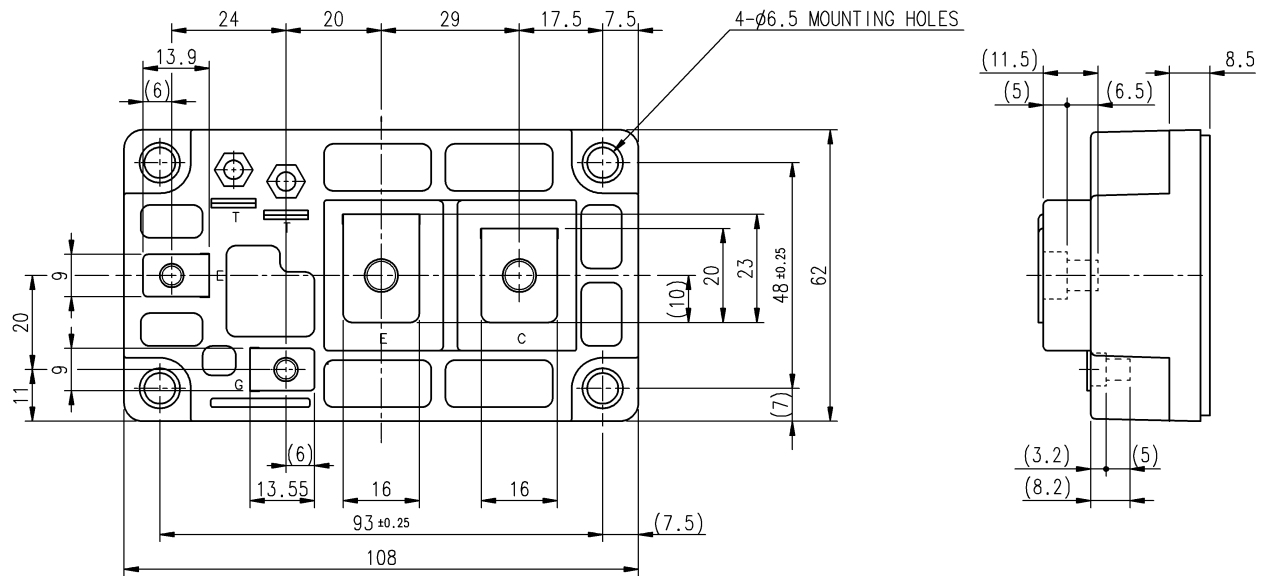

INTERNAL CONNECTION

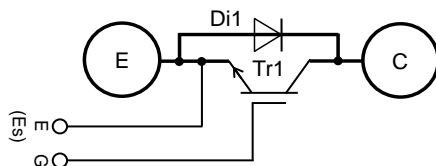

Tolerance otherwise specified

Division of Dimension	Tolerance
0.5 to 3	±0.2
over 3 to 6	±0.3
over 6 to 30	±0.5
over 30 to 120	±0.8
over 120 to 400	±1.2

CM600HA-24AHIGH POWER SWITCHING USE
INSULATED TYPE**MAXIMUM RATINGS (T_j=25 °C, unless otherwise specified)**

Symbol	Item	Conditions	Rating	Unit
V _{CES}	Collector-emitter voltage	G-E short-circuited	1200	V
V _{GES}	Gate-emitter voltage	C-E short-circuited	± 20	V
I _C	Collector current	DC, T _C =80 °C (Note2, 4)	600	A
I _{CRM}		Pulse, Repetitive (Note3)	1200	
P _{tot}	Total power dissipation	T _C =25 °C (Note2, 4)	3670	W
I _E (Note1)	Emitter current	DC (Note2)	600	A
I _{ERM} (Note1)		Pulse, Repetitive (Note3)	1200	
V _{isol}	Isolation voltage	Terminals to base plate, RMS, f=60 Hz, AC 1 min	2500	V
T _j	Operating junction temperature	-	-40 ~ +150	°C
T _{stg}	Storage temperature	-	-40 ~ +125	

ELECTRICAL CHARACTERISTICS (T_j=25 °C, unless otherwise specified)

Symbol	Item	Conditions	Limits			Unit
			Min.	Typ.	Max.	
I _{CES}	Collector-emitter cut-off current	V _{CE} =V _{CES} , G-E short-circuited	-	-	1.0	mA
I _{GES}	Gate-emitter leakage current	V _{GE} =V _{GES} , C-E short-circuited	-	-	1.0	μA
V _{GE(th)}	Gate-emitter threshold voltage	I _C =60 mA, V _{CE} =10 V	6	7	8	V
V _{CEsat}	Collector-emitter saturation voltage	I _C =600 A, V _{GE} =15 V (Note5)	-	2.1	3.0	V
		Refer to the figure of test circuit	-	2.4	-	
C _{ies}	Input capacitance	V _{CE} =10 V, G-E short-circuited	-	-	105	nF
C _{oes}	Output capacitance		-	-	9.0	
C _{res}	Reverse transfer capacitance		-	-	2.0	
Q _G	Gate charge	V _{CC} =600 V, I _C =600 A, V _{GE} =15 V	-	3.0	-	μC
t _{d(on)}	Turn-on delay time	V _{CC} =600 V, I _C =600 A, V _{GE} =±15 V, R _G =0.52 Ω, Inductive load	-	-	660	ns
t _r	Rise time		-	-	190	
t _{d(off)}	Turn-off delay time		-	-	700	
t _f	Fall time		-	-	350	
V _{EC} (Note1)	Emitter-collector voltage	I _E =600 A, G-E short-circuited (Note5) Refer to the figure of test circuit	-	3.0	3.8	V
t _{rr} (Note1)	Reverse recovery time	V _{CC} =600 V, I _E =600 A, V _{GE} =±15 V,	-	-	250	ns
Q _{rr} (Note1)	Reverse recovery charge	R _G =0.52 Ω, Inductive load	-	19	-	μC
E _{on}	Turn-on switching energy per pulse	V _{CC} =600 V, I _C =I _E =600 A,	-	100	-	mJ
E _{off}	Turn-off switching energy per pulse	V _{GE} =±15 V, R _G =0.52 Ω, T _j =125 °C,	-	66	-	
E _{rr} (Note1)	Reverse recovery energy per pulse	Inductive load	-	29.5	-	mJ
r _g	Internal gate resistance	T _C =25 °C (Note4)	-	1.0	-	Ω

THERMAL RESISTANCE CHARACTERISTICS

Symbol	Item	Conditions	Limits			Unit
			Min.	Typ.	Max.	
R _{th(j-c)Q}	Thermal resistance	Junction to case, per IGBT (Note4)	-	-	34	K/kW
R _{th(j-c)D}		Junction to case, per FWD (Note4)	-	-	53	
R _{th(c-s)}	Contact thermal resistance	Case to heat sink, Thermal grease applied (Note4, 6)	-	20	-	K/kW

MECHANICAL CHARACTERISTICS

Symbol	Item	Conditions	Limits			Unit
			Min.	Typ.	Max.	
M _t	Mounting torque	Main terminals M 6 screw	1.96	2.45	2.94	N·m
		G/E auxiliary terminals M 4 screw	0.98	1.18	1.47	
M _s	Mounting torque	Mounting to heat sink M 6 screw	1.96	2.45	2.94	N·m
m	mass	-	-	480	-	g
e _c	Flatness of base plate	On the centerline X, Y (Note7)	±0	-	+100	μm

CM600HA-24A

HIGH POWER SWITCHING USE
INSULATED TYPE

*: This product is compliant with the Restriction of the Use of Certain Hazardous Substances in Electrical and Electronic Equipment (RoHS) directive 2011/65/EU.

Note1. Represent ratings and characteristics of the anti-parallel, emitter-collector free-wheeling diode (FWD).

2. Junction temperature (T_{vj}) should not increase beyond T_{vjmax} rating.
3. Pulse width and repetition rate should be such that the device junction temperature (T_{vj}) dose not exceed T_{vjmax} rating.
4. Case temperature (T_c) and heat sink temperature (T_s) are defined on the each surface (mounting side) of base plate and heat sink just under the chips.
Refer to the figure of chip location.
5. Pulse width and repetition rate should be such as to cause negligible temperature rise. Refer to the figure of test circuit.
6. Typical value is measured by using thermally conductive grease of $\lambda=0.9$ W/(m·K)
7. The base plate (mounting side) flatness measurement points (X, Y) are as follows of the following figure.

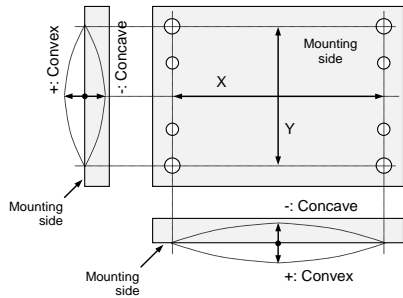

RECOMMENDED OPERATING CONDITIONS

Symbol	Item	Conditions	Limits			Unit
			Min.	Typ.	Max.	
V_{CC}	(DC) Supply voltage	Applied across C-E terminals	-	600	800	V
V_{GEon}	Gate (-emitter drive) voltage	Applied across G-Es terminals	13.5	15.0	16.5	V
R_G	External gate resistance	Per switch	0.52	-	7.8	Ω

CHIP LOCATION (Top view)

Dimension in mm, tolerance: ± 1 mm

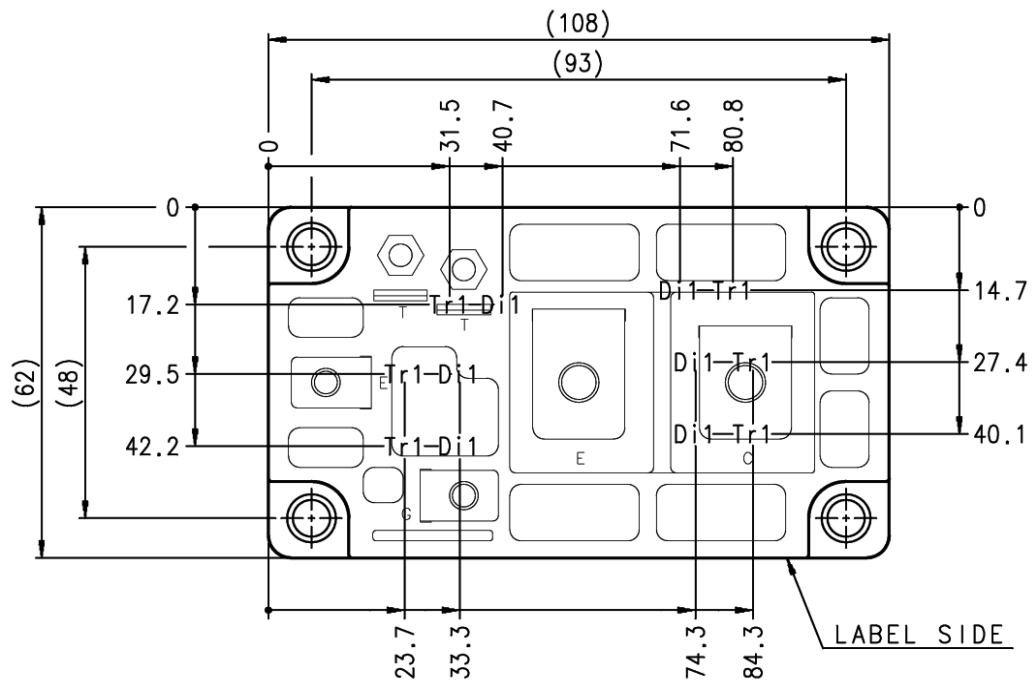

Tr1/Tr2: IGBT, Di1/Di2: FWD

CM600HA-24A

HIGH POWER SWITCHING USE
INSULATED TYPE

TEST CIRCUIT AND WAVEFORMS

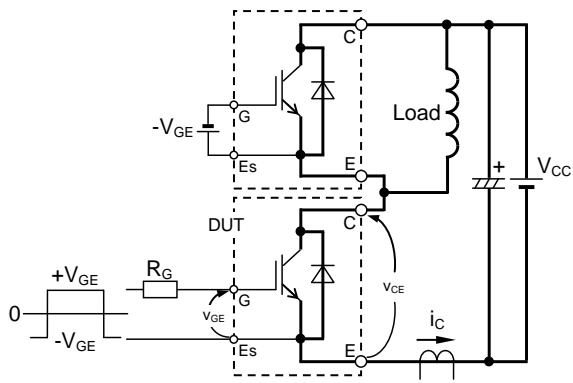

Switching characteristics test circuit and waveforms

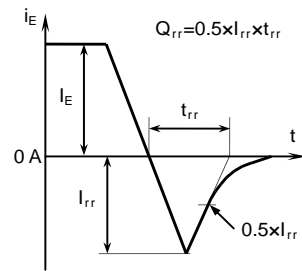
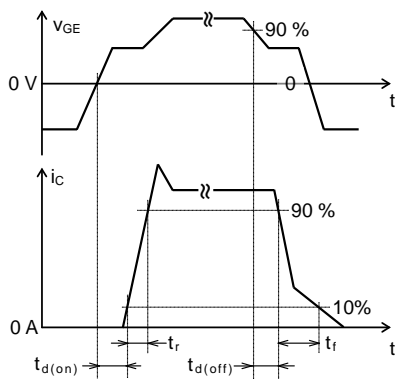

t_{rr} , Q_{rr} characteristics test waveform

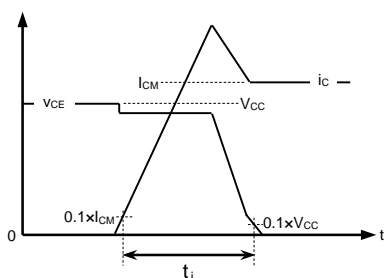

IGBT Turn-on switching energy

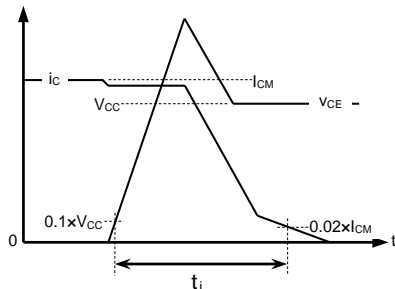

IGBT Turn-off switching energy

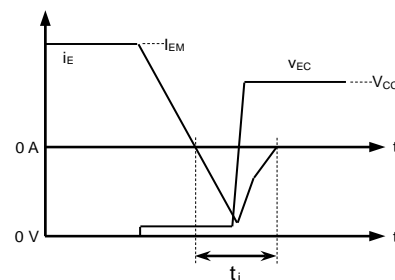

FWD Reverse recovery energy

Turn-on / Turn-off switching energy and Reverse recovery energy test waveforms (Integral time instruction drawing)

TEST CIRCUIT

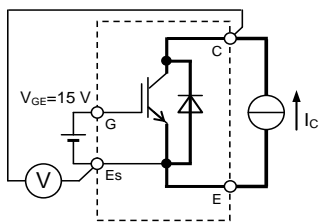

V_{CEsat} characteristics test circuit

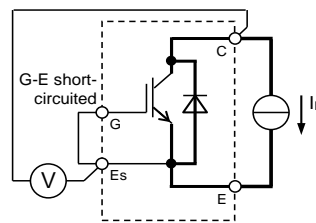

V_{EC} characteristics test circuit

CM600HA-24A

HIGH POWER SWITCHING USE
INSULATED TYPE

PERFORMANCE CURVES

OUTPUT CHARACTERISTICS

(TYPICAL)

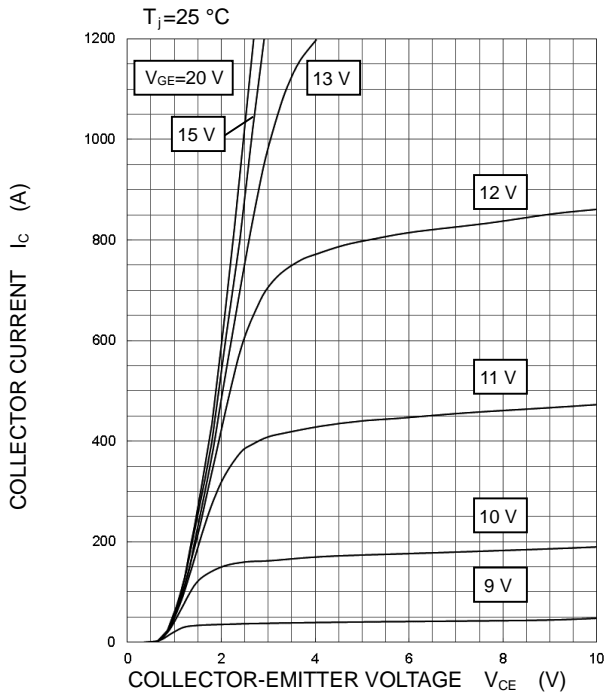

COLLECTOR-EMITTER SATURATION VOLTAGE CHARACTERISTICS

(TYPICAL)

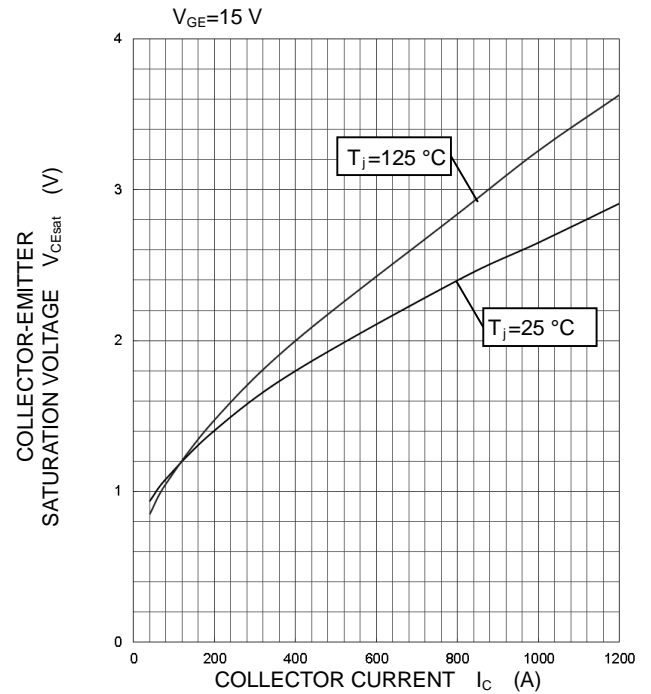

COLLECTOR-EMITTER SATURATION VOLTAGE CHARACTERISTICS

(TYPICAL)

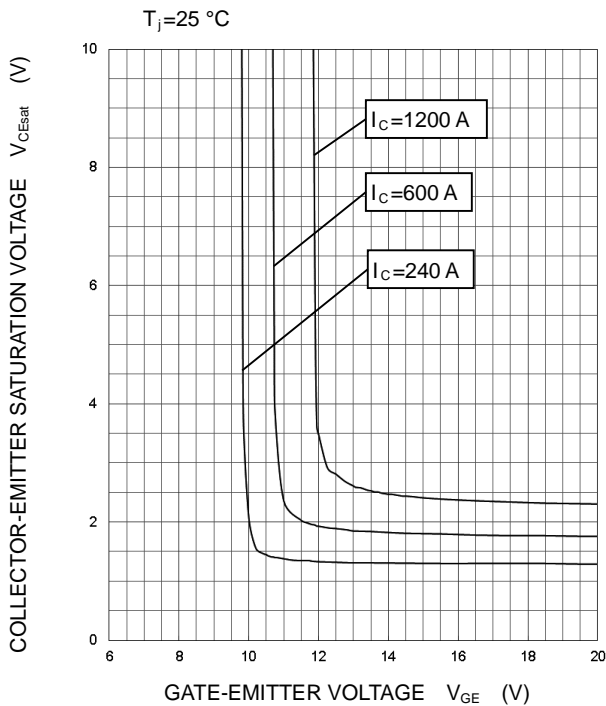

FREE WHEELING DIODE FORWARD CHARACTERISTICS

(TYPICAL)

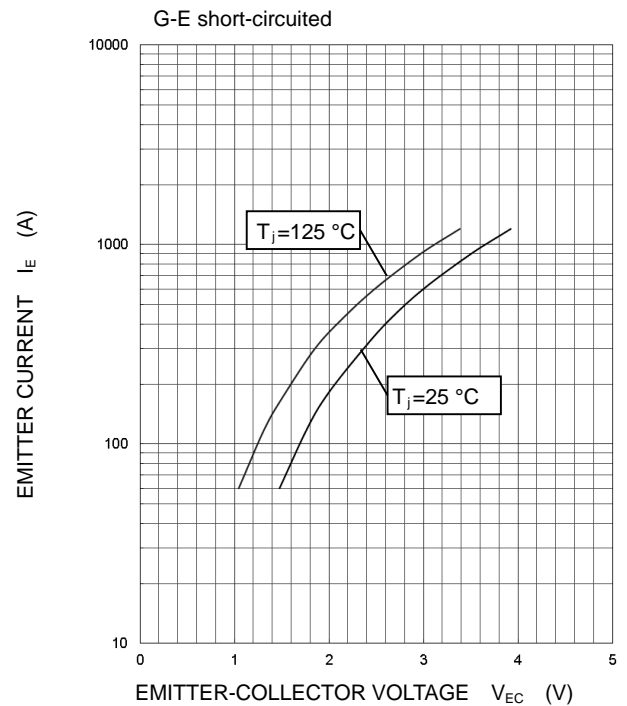

CM600HA-24A

HIGH POWER SWITCHING USE
INSULATED TYPE

PERFORMANCE CURVES

HALF-BRIDGE SWITCHING CHARACTERISTICS (TYPICAL)

$V_{CC}=600\text{ V}$, $V_{GE}=\pm 15\text{ V}$, $R_G=0.52\ \Omega$,
 $T_j=125\text{ }^\circ\text{C}$, INDUCTIVE LOAD

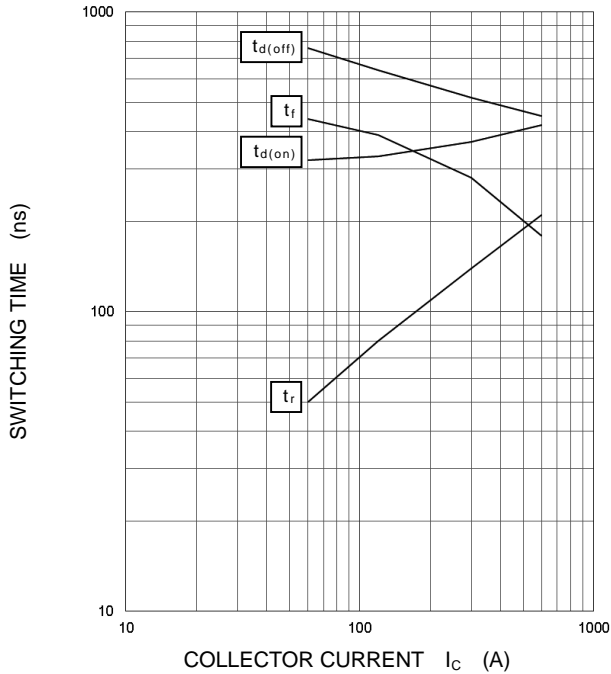

HALF-BRIDGE SWITCHING CHARACTERISTICS (TYPICAL)

$V_{CC}=600\text{ V}$, $V_{GE}=\pm 15\text{ V}$, $R_G=0.52\ \Omega$, $T_j=125\text{ }^\circ\text{C}$
INDUCTIVE LOAD, PER PULSE

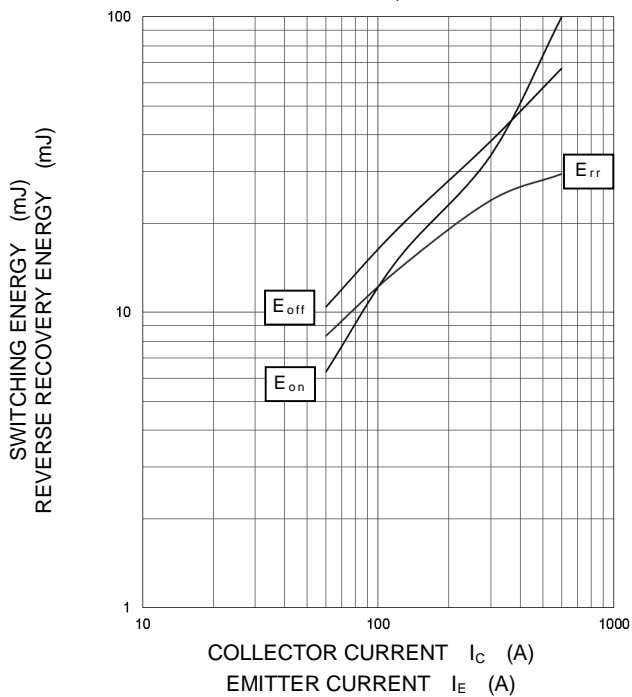

HALF-BRIDGE SWITCHING CHARACTERISTICS (TYPICAL)

$V_{CC}=600\text{ V}$, $V_{GE}=\pm 15\text{ V}$, $I_C/I_E=600\text{ A}$, $T_j=125\text{ }^\circ\text{C}$
INDUCTIVE LOAD, PER PULSE

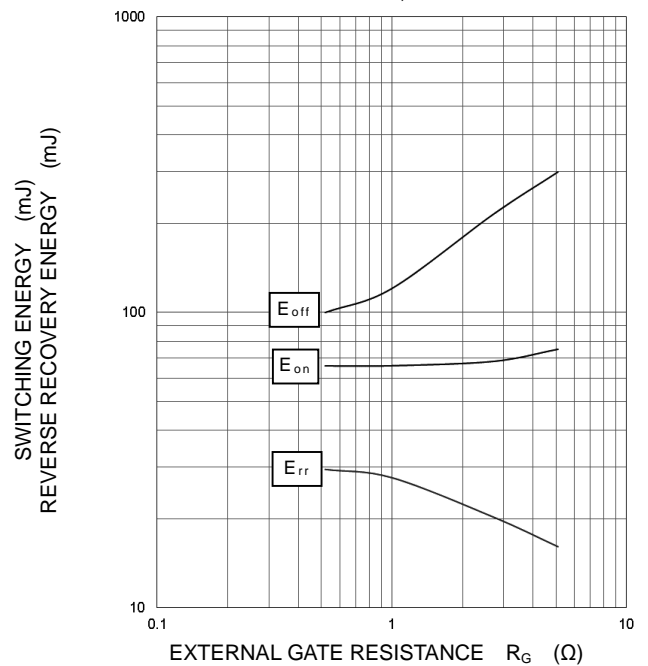

CM600HA-24A

HIGH POWER SWITCHING USE
INSULATED TYPE

PERFORMANCE CURVES

CAPACITANCE CHARACTERISTICS

(TYPICAL)

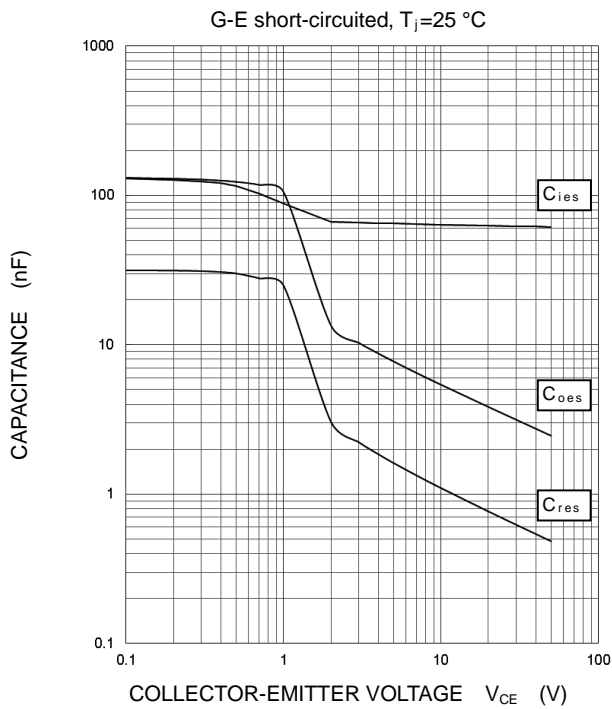

FREE WHEELING DIODE REVERSE RECOVERY CHARACTERISTICS

(TYPICAL)

$V_{CC}=600\text{ V}$, $V_{GE}=\pm 15\text{ V}$, $R_G=0.52\text{ }\Omega$,
 $T_j=125\text{ }^\circ\text{C}$. INDUCTIVE LOAD

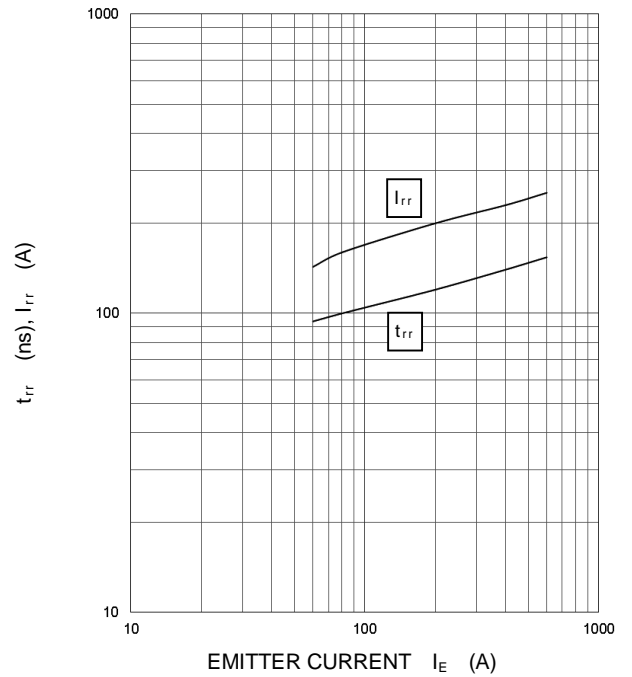

GATE CHARGE CHARACTERISTICS

(TYPICAL)

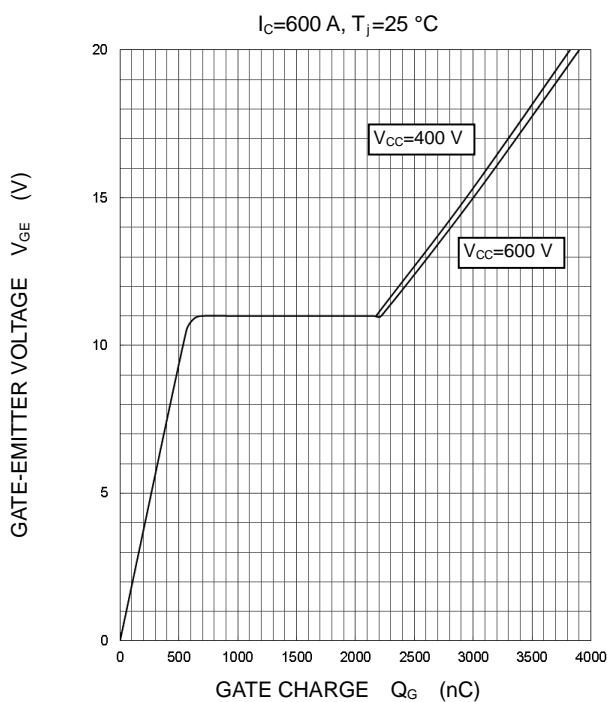

TRANSIENT THERMAL IMPEDANCE CHARACTERISTICS

(MAXIMUM)

Single pulse, $T_C=25\text{ }^\circ\text{C}$
 $R_{th(j-c)Q}=34\text{ K/kW}$, $R_{th(j-c)D}=53\text{ K/kW}$

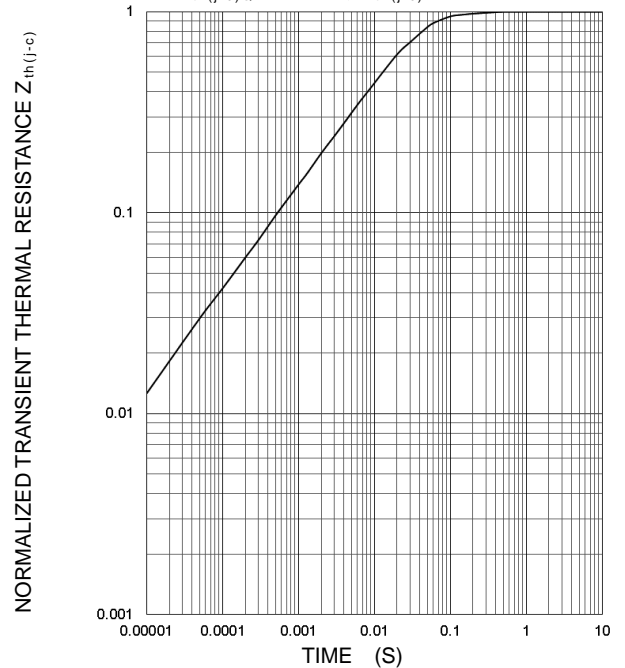

Note: The characteristics curves are presented for reference only and not guaranteed by production test, unless otherwise noted.

CM600HA-24A

HIGH POWER SWITCHING USE
INSULATED TYPE

PERFORMANCE CURVES

**TURN-OFF SWITCHING SAFE OPERATING AREA
(REVERSE BIAS SAFE OPERATING AREA)
(MAXIMUM)**

$V_{CC} \leq 800 \text{ V}$, $V_{GE} = \pm 15 \text{ V}$, $R_G = 0.52 \sim 7.8 \ \Omega$, $T_j = 25 \sim 125 \text{ }^\circ\text{C}$

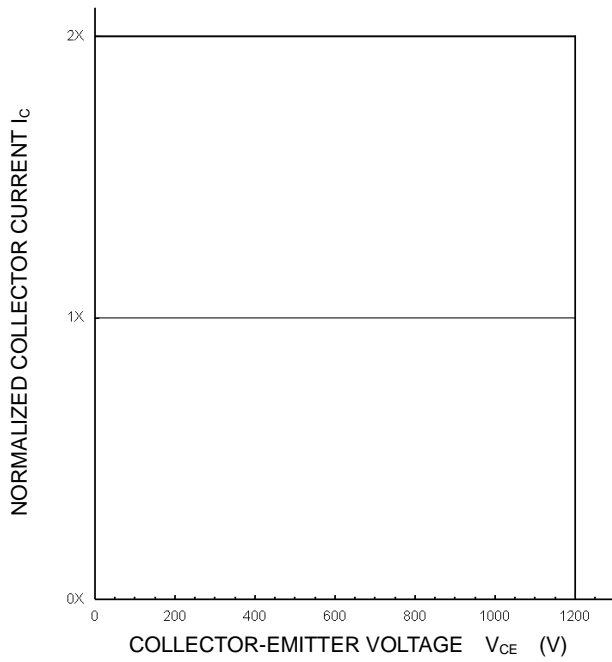

**SHORT-CIRCUIT SAFE OPERATING AREA
(MAXIMUM)**

$V_{CC} \leq 800 \text{ V}$, $V_{GE} = \pm 15 \text{ V}$, $R_G = 0.52 \sim 7.8 \ \Omega$,
 $T_j = 25 \sim 125 \text{ }^\circ\text{C}$, $t_w \leq 10 \ \mu\text{s}$, Non-Repetitive

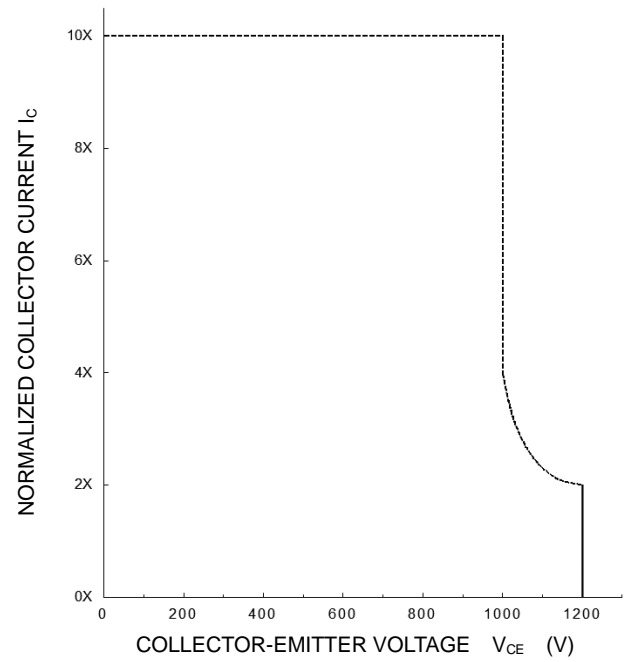

Important Notice

The information contained in this datasheet shall in no event be regarded as a guarantee of conditions or characteristics. This product has to be used within its specified maximum ratings, and is subject to customer's compliance with any applicable legal requirement, norms and standards.

Except as otherwise explicitly approved by Mitsubishi Electric Corporation in a written document signed by authorized representatives of Mitsubishi Electric Corporation, our products may not be used in any applications where a failure of the product or any consequences of the use thereof can reasonably be expected to result in personal injury.

In usage of power semiconductor, there is always the possibility that trouble may occur with them by the reliability lifetime such as Power Cycle, Thermal Cycle or others, or when used under special circumstances (e.g. condensation, high humidity, dusty, salty, highlands, environment with lots of organic matter / corrosive gas / explosive gas, or situations which terminals of semiconductor products receive strong mechanical stress). Therefore, please pay sufficient attention to such circumstances. Further, depending on the technical requirements, our semiconductor products may contain environmental regulation substances, etc. If there is necessity of detailed confirmation, please contact our nearest sales branch or distributor.

The contents or data contained in this datasheet are exclusively intended for technically trained staff. Customer's technical departments should take responsibility to evaluate the suitability of Mitsubishi Electric Corporation product for the intended application and the completeness of the product data with respect to such application. In the customer's research and development, please evaluate it not only with a single semiconductor product but also in the entire system, and judge whether it's applicable. As required, pay close attention to the safety design by installing appropriate fuse or circuit breaker between a power supply and semiconductor products to prevent secondary damage. Please also pay attention to the application note and the related technical information.

Keep safety first in your circuit designs!

Mitsubishi Electric Corporation puts the maximum effort into making semiconductor products better and more reliable, but there is always the possibility that trouble may occur with them. Trouble with semiconductors may lead to personal injury, fire or property damage. Remember to give due consideration to safety when making your circuit designs, with appropriate measures such as (i) placement of substitutive, auxiliary circuits, (ii) use of non-flammable material or (iii) prevention against any malfunction or mishap.

Notes regarding these materials

- These materials are intended as a reference to assist our customers in the selection of the Mitsubishi Electric Semiconductor product best suited to the customer's application; they do not convey any license under any intellectual property rights, or any other rights, belonging to Mitsubishi Electric Corporation or a third party.
- Mitsubishi Electric Corporation assumes no responsibility for any damage, or infringement of any third-party's rights, originating in the use of any product data, diagrams, charts, programs, algorithms, or circuit application examples contained in these materials.
- All information contained in these materials, including product data, diagrams, charts, programs and algorithms represents information on products at the time of publication of these materials, and are subject to change by Mitsubishi Electric Corporation without notice due to product improvements or other reasons. It is therefore recommended that customers contact Mitsubishi Electric Corporation or an authorized Mitsubishi Electric Semiconductor product distributor for the latest product information before purchasing a product listed herein.
The information described here may contain technical inaccuracies or typographical errors. Mitsubishi Electric Corporation assumes no responsibility for any damage, liability, or other loss rising from these inaccuracies or errors.
Please also pay attention to information published by Mitsubishi Electric Corporation by various means, including the Mitsubishi Electric Semiconductor home page (<http://www.MitsubishiElectric.com/semiconductors/>).
- When using any or all of the information contained in these materials, including product data, diagrams, charts, programs, and algorithms, please be sure to evaluate all information as a total system before making a final decision on the applicability of the information and products. Mitsubishi Electric Corporation assumes no responsibility for any damage, liability or other loss resulting from the information contained herein.
- Mitsubishi Electric Corporation semiconductors are not designed or manufactured for use in a device or system that is used under circumstances in which human life is potentially at stake. Please contact Mitsubishi Electric Corporation or an authorized Mitsubishi Electric Semiconductor product distributor when considering the use of a product contained herein for any specific purposes, such as apparatus or systems for transportation, vehicular, medical, aerospace, nuclear, or undersea repeater use.
- The prior written approval of Mitsubishi Electric Corporation is necessary to reprint or reproduce in whole or in part these materials.
- If these products or technologies are subject to the Japanese export control restrictions, they must be exported under a license from the Japanese government and cannot be imported into a country other than the approved destination.
Any diversion or re-export contrary to the export control laws and regulations of Japan and/or the country of destination is prohibited.
- Please contact Mitsubishi Electric Corporation or an authorized Mitsubishi Electric Semiconductor product distributor for further details on these materials or the products contained therein.

Generally the listed company name and the brand name are the trademarks or registered trademarks of the respective companies.