

FEATURES

- UL 60950 recognised for reinforced insulation
- ANSI/AAMI ES60601-1, 1 MOPP/ 2 MOOPs recognised⁴
- 3kVAC isolation test voltage 'Hi Pot Test'
- Continuous short circuit protection
- Output voltage trim
- Remote on/off pin
- No electrolytic capacitors
- Operation up to 105°C (With derating)
- 2:1 input range

PRODUCT OVERVIEW

The MTC1 series of miniature surface mount DC-DC converters offers a single output voltage from input voltage ranges of 4.5-9V, 9-18V and 18-36V. The MTC1 series regulated output voltage is adjustable by $\pm 10\%$ and a remote on/off pin is also included for application power saving.

The MTC1 ideally suited to applications which include medical, industrial, telecommunications, battery powered systems and process automation.

SELECTION GUIDE

Order Code ¹	Input Voltage		Output Voltage	Output Current	Rated Input Current	Efficiency		Ripple and Noise		MTTF ²	
	Nom.	V				Min.	Typ.	Typ.	Max.	MIL.	Tel.
	V	V	mA	mA	%	%	mVp/p	mVp/p	kHrs	kHrs	
MTC1S0503MC ³	5	3.3	303	270	72	75	70	120	1938	4597	
MTC1S0505MC ³	5	5	200	270	72	76	70	120	1825	4658	
MTC1S0512MC ³	5	12	83	270	73	76.5	50	120	1841	5793	
MTC1S1203MC	12	3.3	303	110	72	75	25	50	1463	4635	
MTC1S1205MC	12	5	200	110	77	78.5	25	50	1735	5751	
MTC1S1212MC	12	12	83	100	77	79	20	40	1559	6056	
MTC1S2403MC	24	3.3	303	55	73	75.5	30	55	1508	5085	
MTC1S2405MC	24	5	200	55	74	76.5	25	50	1499	5458	
MTC1S2412MC	24	12	83	55	75	77	25	50	1435	5234	

INPUT CHARACTERISTICS

Parameter	Conditions	Min.	Typ.	Max.	Units
Voltage range	5V input types	4.5	5	9	V
	12V input types	9	12	18	
	24V input types	18	24	36	
Input reflected ripple current	0503		10		mA p-p
	0505		15		
	0512		25		
	All other variants		2		

ISOLATION CHARACTERISTICS

Parameter	Conditions	Min.	Typ.	Max.	Units
Isolation test voltage	Production tested for 1 second	3000			VAC
	Qualification tested for 1 minute	3000			VAC
Isolation capacitance	5V input types		20		pF
	All other variants		7		
Resistance	Viso = 1kVDC	1			GΩ
Safety Standard	UL60950-1 Reinforced			250	VAC
	ANSI/AAMI ES60601-1 1 MOPP/2 MOOP	Creepage and clearance 5mm		250	

OUTPUT CHARACTERISTICS

Parameter	Conditions	Min.	Typ.	Max.	Units
Rated power	All output types			1	W
Minimal load to meet datasheet specification		10			%
Voltage set point accuracy	3V, 5V output & 5V input types	-2.5		2	%
	1212 & 2412	-3		2	
Line regulation	Low line to high line		± 0.05	± 0.2	%
Load regulation	All output types		± 0.05	± 0.2	%



For full details go to www.murata-ps.com/rohs



1. Components are supplied in tape and reel packaging, please refer to package specification section. Orderable part numbers are MTC1SXXXXMC-R7 (30 pieces per reel), or MTC1SXXXXMC-R13 (150 pieces per reel).
2. Calculated using MIL-HDBK-217 FN2 and Telecordia SR-332 calculation model with nominal input voltage at full load.
3. MTC1S05xxMC variants are currently pending recognition to UL62368-1 as UL60950 is superseded by UL62368.
4. ANSI/AAMI ES60601-1 recognition is currently pending for MTC1S05xxMC.

All specifications typical at $T_A = 25^\circ\text{C}$, nominal input voltage and rated output current unless otherwise specified.

OUTPUT CHARACTERISTICS (Continued)							
Parameter	Conditions		Min.	Typ.	Max.	Units	
Transient response	Peak deviation (25-75% & 75-25% swing)	0512			±1	%V _{out}	
		2403			±4		
		2405			±3		
		All other variants			±2		
	Settling time (within 5% V _{out} Nom.)	0503			350		µs
		0505			400		
		0512			100		
		1203			220		
		1205			260		
		1212, 2403 & 2405			100		
	2412			70			

GENERAL CHARACTERISTICS						
Parameter	Conditions		Min.	Typ.	Max.	Units
Switching frequency	0503			125		kHz
	0505			85		
	0512			110		
	1203, 2405, 2403 variants			240		
	1205, 2412 variants			260		
	1212			300		
Remote on/off pin	Module on, pin unconnected or open collector floating					V
	Module off (refer to application notes)			2		
	5V input types			0.25		mW
	12V input types			1.5		
	24V input types			3.9		

TEMPERATURE CHARACTERISTICS						
Parameter	Conditions		Min.	Typ.	Max.	Units
Operation	See derating curves		-40		105	°C
Storage			-50		125	
Case temperature above ambient	100% Load, Nom V _{IN} , Still Air			15		

ABSOLUTE MAXIMUM RATINGS						
Short-circuit protection (for SELV input voltages)						Continuous
Remote on/off pin input voltage						6V
Input voltage, MTC1 5V input types						15V
Input voltage, MTC1 12V input types						25V
Input voltage, MTC1 24V input types						40V

TECHNICAL NOTES

ISOLATION VOLTAGE

'Hi Pot Test', 'Flash Tested', 'Withstand Voltage', 'Proof Voltage', 'Dielectric Withstand Voltage' & 'Isolation Test Voltage' are all terms that relate to the same thing, a test voltage, applied for a specified time, across a component designed to provide electrical isolation, to verify the integrity of that isolation.

Murata Power Solutions MTC1 series of DC-DC converters are all 100% production tested at 3kVAC for 1 second and have been qualification tested at 3kVAC for 1 minute.

A question commonly asked is, "What is the continuous voltage that can be applied across the part in normal operation?"

The MTC1 series has been recognised by Underwriters Laboratory to 250 Vrms Reinforced Insulation, please see safety approval section below.

REPEATED HIGH-VOLTAGE ISOLATION TESTING

It is well known that repeated high-voltage isolation testing of a barrier component can actually degrade isolation capability, to a lesser or greater degree depending on materials, construction and environment. We therefore strongly advise against repeated high voltage isolation testing, but if it is absolutely required, that the voltage be reduced by 20% from specified test voltage.

SAFETY APPROVAL

ANSI/AAMI ES60601-1

The MTC1 series has been recognised by Underwriters Laboratory (UL) to ANSI/AAMI ES60601-1 and provides 1 MOPP (Means Of Patient Protection) and 2 MOOP (Means Of Operator Protection) based upon a working voltage of 250 Vrms max., between Primary and Secondary. The MTC1S05xxMC variants are currently pending recognition.

File number E202895 applies.

UL 60950

The MTC1 series has been recognised by Underwriters Laboratory (UL) to UL 60950 for reinforced insulation to a working voltage of 250 Vrms. File number E151252 applies.

Creepage and clearance is 5mm.

FUSING

The MTC1 Series of converters are not internally fused so to meet the requirements of UL an anti-surge input line fuse should always be used with ratings as defined below.

Input Voltage, 5V: 0.5A (Fuse value is pending Underwriters Laboratory (UL) confirmation.)

Input Voltage, 12V: 0.5A

Input Voltage, 24V: 0.25A

All fuses should be UL recognised and rated to 125V.

RoHS COMPLIANCE, MSL AND PSL INFORMATION



This series is compatible with Pb-Free soldering systems and is also backward compatible with Sn/Pb soldering systems.

The MTC1 series has a process, moisture, and reflow sensitivity classification of MSL2 PSL R7F as defined in J-STD-020 and J-STD-075. This translates to: MSL2 = 1 year floor life, PSL R7F = Peak reflow temperature 245°C with a limitation on the time above liquidus (217°C) which for this series is 90 sec max. Please refer to [application notes](#) for further information. The pin termination finish on this product series is Gold with Nickel Pre-plate.

PART NUMBER STRUCTURE

MTC 1 S XX XX M C -RXX

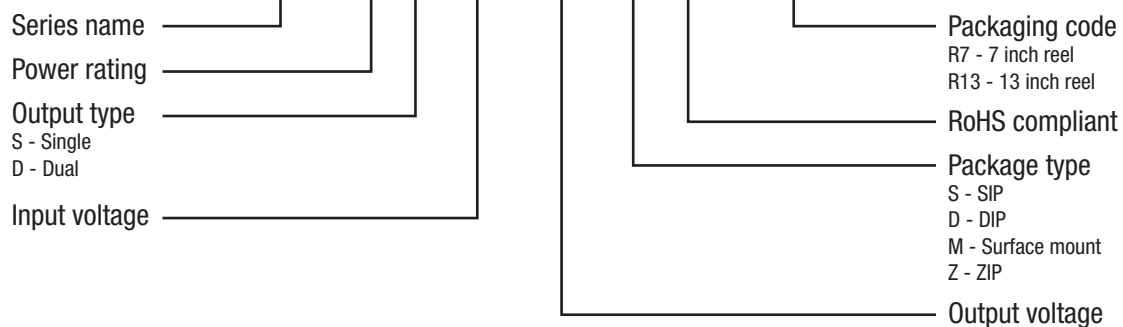

ENVIRONMENTAL VALIDATION TESTING

The following tests have been conducted on this product series, please contact Murata if further information about the tests is required.

Test	Standard	Condition
Temperature cycling	MIL-STD-883 1010, Condition B	10 cycles between two chambers set to achieve -55°C and +125°C. The dwell time shall not be less than 10min and the load shall reach the specified temperature in 15min.
HAST (biased)	JEDEC JESD22-A110	96Hrs +2/-0Hrs at 130°C ± 2°C, 85% ± 5% R.H.
High temperature storage life	JEDEC JESD22-A103, Condition A	125°C +10/-0°C for ≥1000 hours
Vibration	BS EN 61373 with respect to BS EN 60068-2-64, Test Fh Category 1 Class B	5 – 150Hz. Level at each axis – Vertical, Traverse and Longitudinal: 5.72m/s ² rms. 5 hours in each axis. Crest factor: 3 Sigma. Device is secured via pins.
Shock	BS EN 61373: Category 1 Class B	Test is 30ms duration, 3 shocks in each sense of 3 mutually perpendicular axes (18 shocks total). Level at each axis as follows: Vertical, Traverse and Longitudinal: 50m/s ² . Device is secured via pins.
Solderability	IPC/ECA J-STD-002, Test A and A1	SnPb (Test A): For lead free solderability, 5 off Parts conditioned to a 48hour dry bake at 125°C followed by 4 hours at 155°C and 5 off Parts conditioned to 96hours at 125°C. All 10 Dipped in solder at 245°C ±5°C for 5 +0/-0.5 seconds. Pb-free (Test A1): For leaded solderability, 5 off Parts conditioned to a 48hour dry bake at 125°C followed by 4 hours at 155°C and 5 off Parts conditioned to 96hours at 125°C. All 10 Dipped in solder at 255°C ±5°C for 5 +0/-0.5 seconds.
Solvent cleaning	Resistance to cleaning agents	Solvent – Novec 71IPA & Topklean EL-20A. Pulsed ultrasonic immersion 45°C- 65°C
Solvent resistance	MIL-STD-883, Method 2015	The parts and the bristle portion of the brush are immersed in Isopropanol for a minimum of 1 minute. The parts are brushed 3 times, after the third time the parts are blown dry and inspected.

CHARACTERISATION TEST METHODS

Ripple & Noise Characterisation Method

Ripple and noise measurements are performed with the following test configuration.

C1	1µF X7R multilayer ceramic capacitor, voltage rating to be a minimum of 3 times the output voltage of the DC-DC converter
C2	10µF tantalum capacitor, voltage rating to be a minimum of 1.5 times the output voltage of the DC-DC converter with an ESR of less than 100mΩ at 100 kHz
C3	100nF multilayer ceramic capacitor, general purpose
R1	450Ω resistor, carbon film, ±1% tolerance
R2	50Ω BNC termination
T1	3T of the coax cable through a ferrite toroid
RLOAD	Resistive load to the maximum power rating of the DC-DC converter. Connections should be made via twisted wires

Measured values are multiplied by 10 to obtain the specified values.

Differential Mode Noise Test Schematic

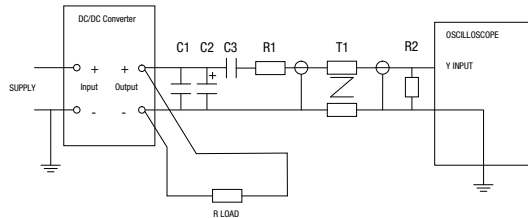

APPLICATION NOTES

Maximum Output Capacitance

Maximum output capacitance should not exceed:

Output Voltage V	Maximum Load Capacitance µF
3.3	470
5	470
12	220

Start-up times

Typical start up times for this series, with a typical input voltage rise time of 2.2µs and output capacitance of 10µF, are shown in the table below. The product series will start into the maximum output capacitance with increased start times.

Part No.	Start-up times
	ms
MTC1S0503MC	6
MTC1S0505MC	12
MTC1S0512MC	30
MTC1S1203MC	5
MTC1S1205MC	14
MTC1S1212MC	25
MTC1S2403MC	9
MTC1S2405MC	14
MTC1S2412MC	25

Typical Wave Form:

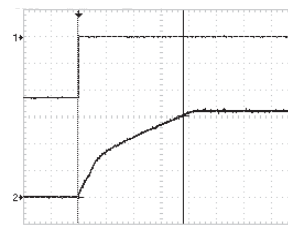

APPLICATION NOTES (Continued)

Control Pin

The MTC1 converters have a shutdown feature which enables the user to disable the converter into a low power state. The control pin connects to the base of an internal NPN transistor with the converter shut down when the transistor is turned on by an external applied voltage. The converter can also be shut down using a 5V TTL signal (the unit is OFF for logic High and ON for logic LOW). If the control pin is left open (high impedance), the converter will run normally. A suitable application circuit is shown below.

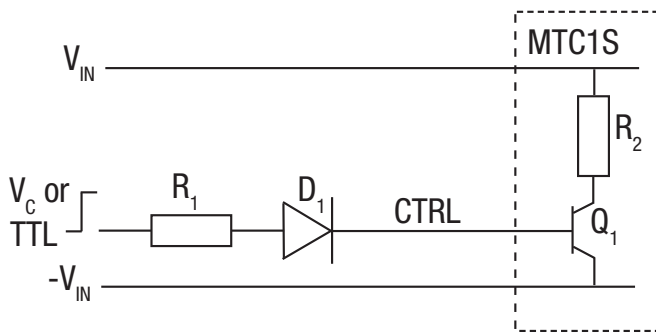

D_1 (e.g. 1N4001) is necessary for correct operation of the MTC1 when the control signal is LOW. The recommended drive current I_b to shut down the MTC1 is 6mA to 15mA. The value of R_1 can be derived as follows:

$$R_1 = \frac{V_c - V_D - 0.6}{I_b}$$

For a switch input:
Calculate the value of R_1 from the above equation given switch voltage V_c and chosen current between 6 and 15mA.

For 5V TTL Signal:
Set R_1 to be between 320Ω to 800Ω.

Output Voltage Adjustment

The MTC1S series has a trim capability which is located at pin 3, this allows the user to independently adjust the output voltages by ±10%. Adjustments to the output voltages can be accomplished via a single fixed resistor as shown in Figures 1 and 2. A single fixed resistor can increase or decrease the output voltage depending on its connection. Fixed resistors should have low temperature coefficient to minimize sensitivity to changes in temperature.

A single resistor connected from the TRIM pin (pin 3) to the +Vout (pin 4), will decrease the output voltage which is shown in figure 1.

A single resistor connected from the TRIM pin (pin 3) to the -Vout (pin 2) will increase the output voltage which is shown in figure 2.

TRIM DOWN

Figure 1. Trim connections to decrease the output voltage

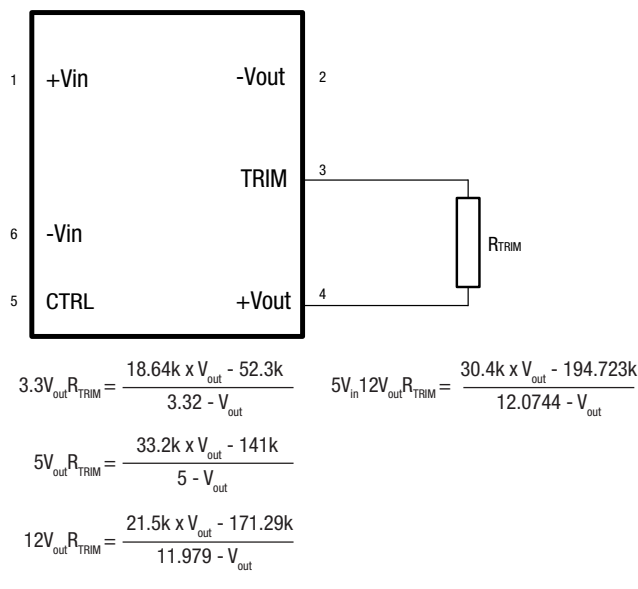

TRIM UP

Figure 2. Trim connections to increase the output voltage

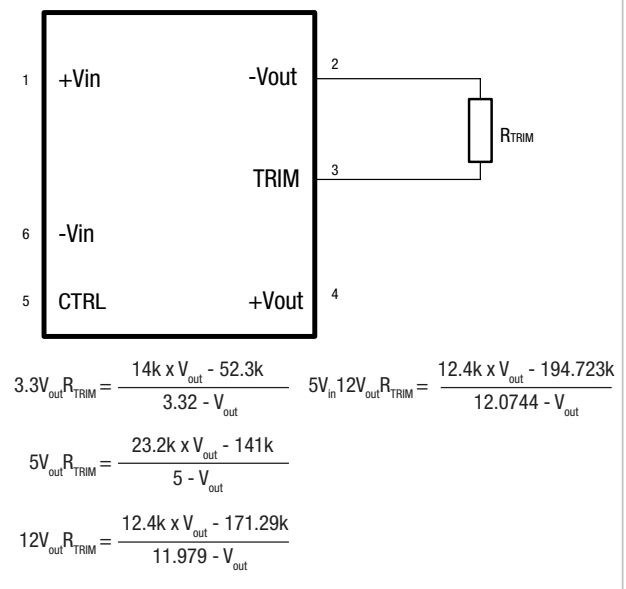

Accuracy of adjustment is subject to tolerances of resistors and factory adjusted output accuracy. Vout is equal to the desired output voltage.

EFFICIENCY VS LOAD

MTC1S0503MC

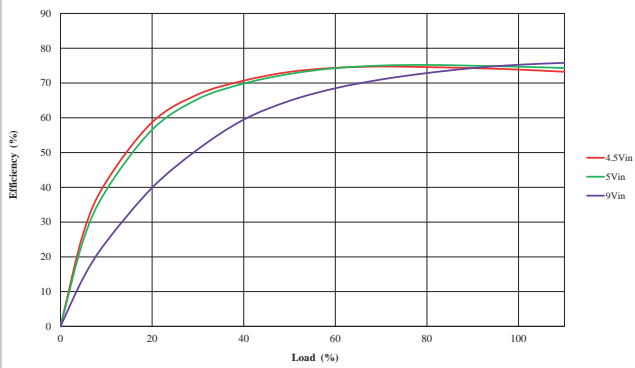

MTC1S0505MC

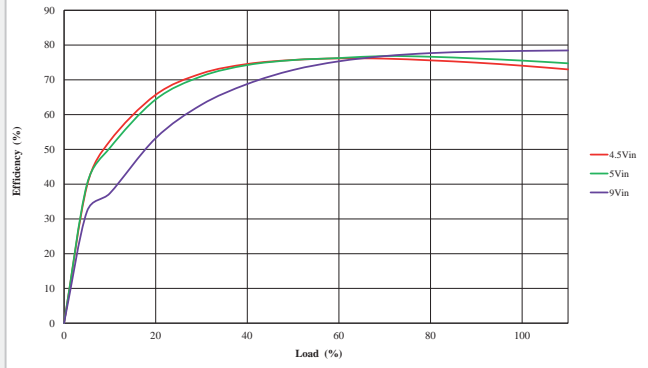

MTC1S0512MC

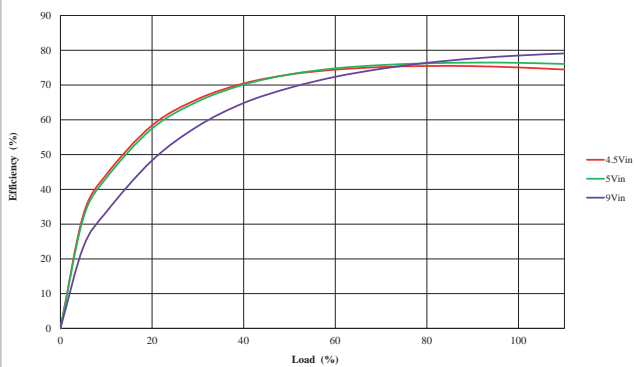

MTC1S1203MC

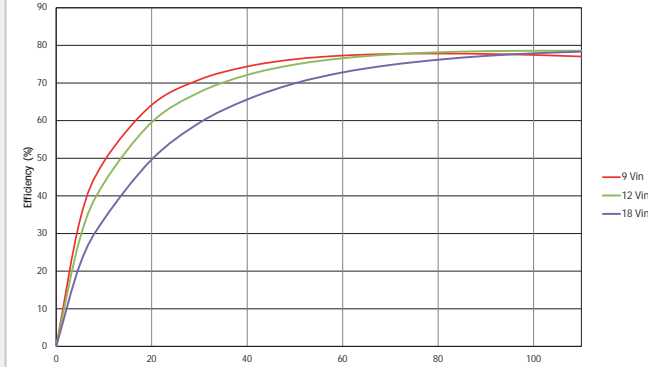

MTC1S1205MC

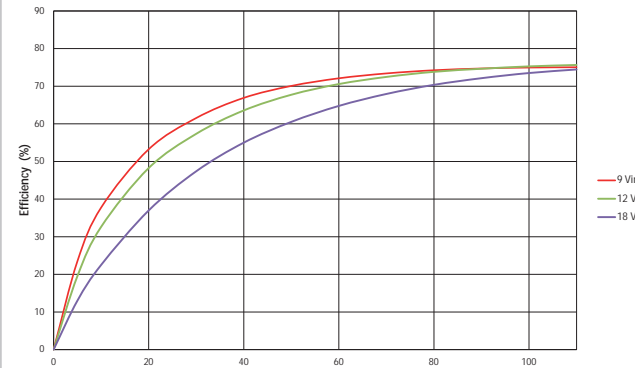

MTC1S1212MC

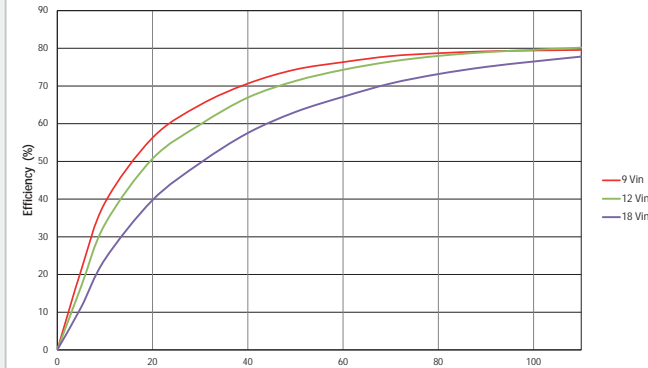

EFFICIENCY VS LOAD

MTC1S2403MC

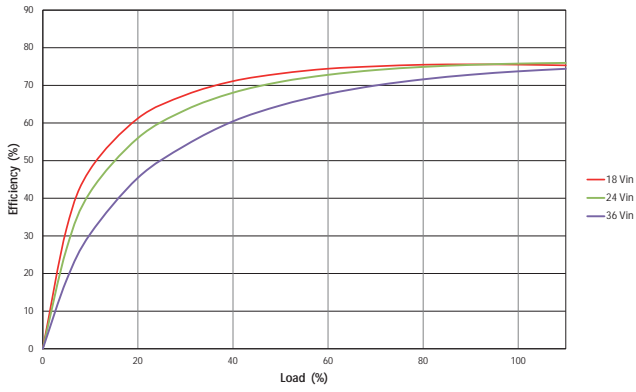

MTC1S2405MC

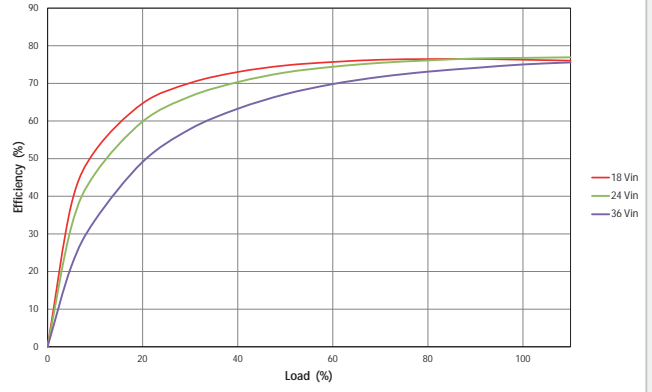

MTC1S2412MC

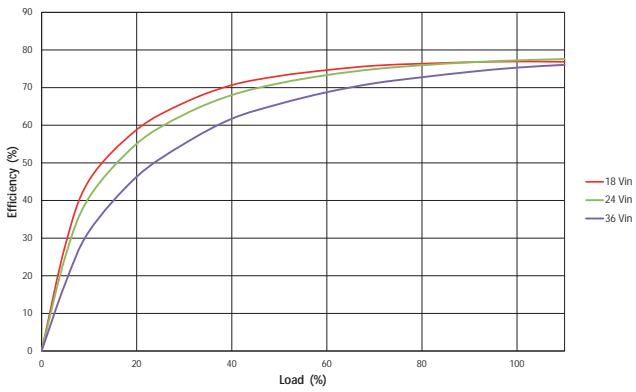

TEMPERATURE DERATING (Continued)

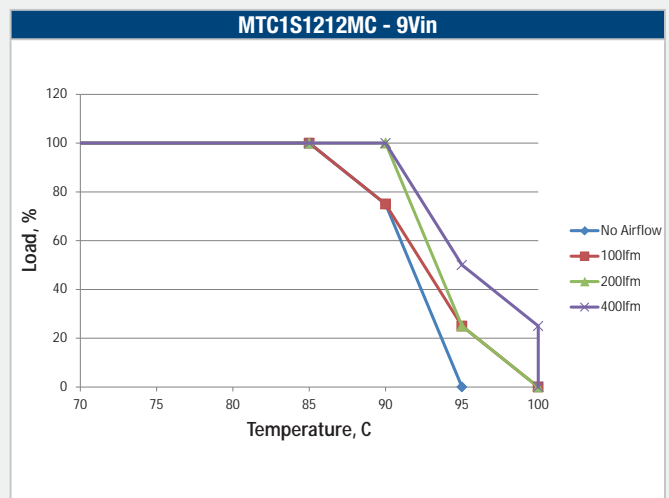
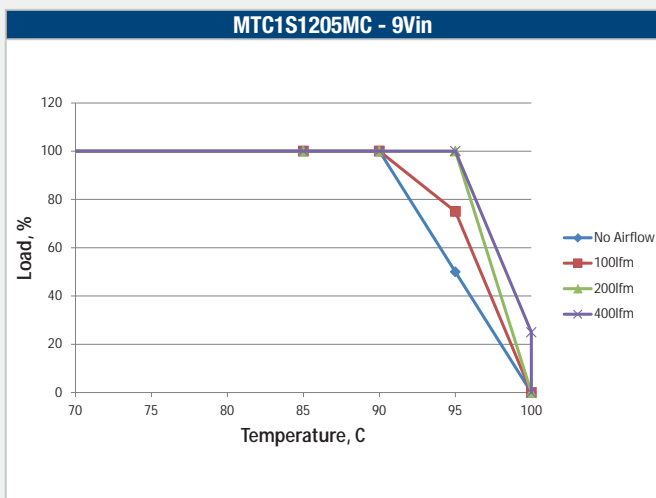
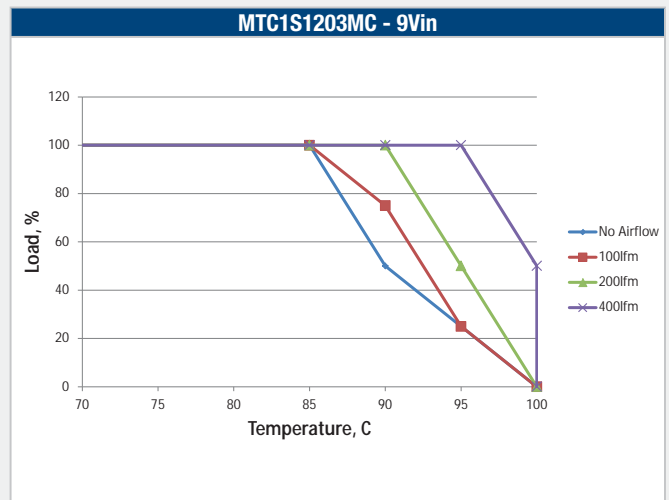
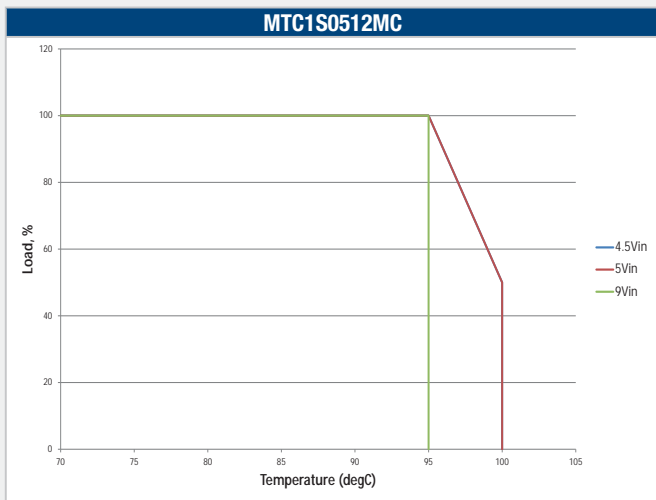
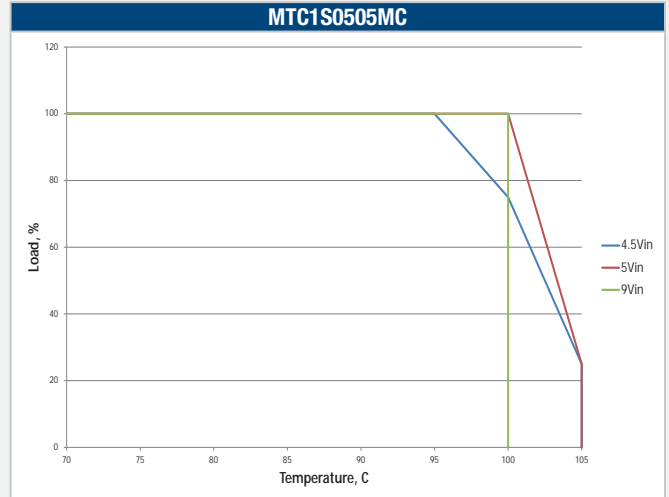
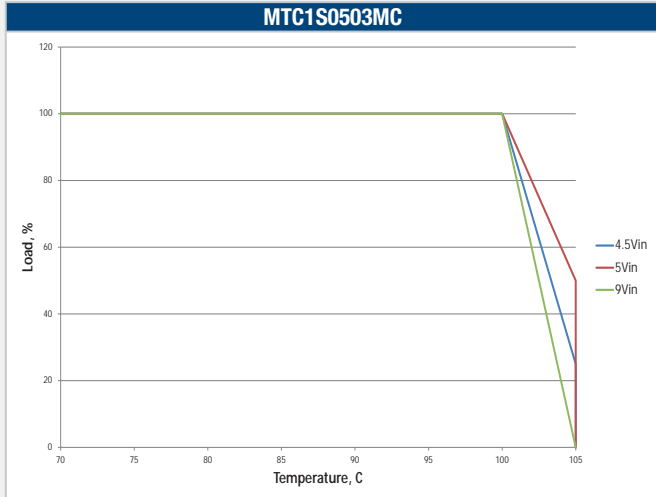

TEMPERATURE DERATING

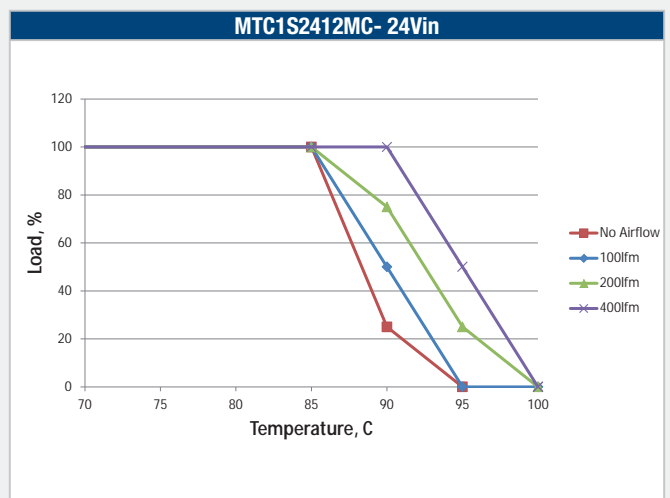
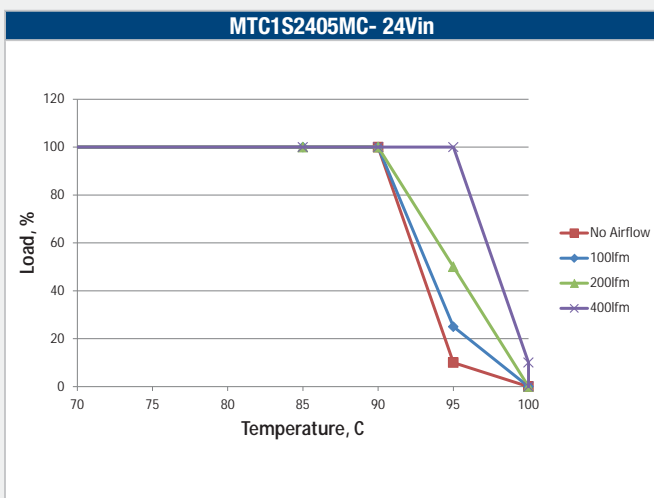
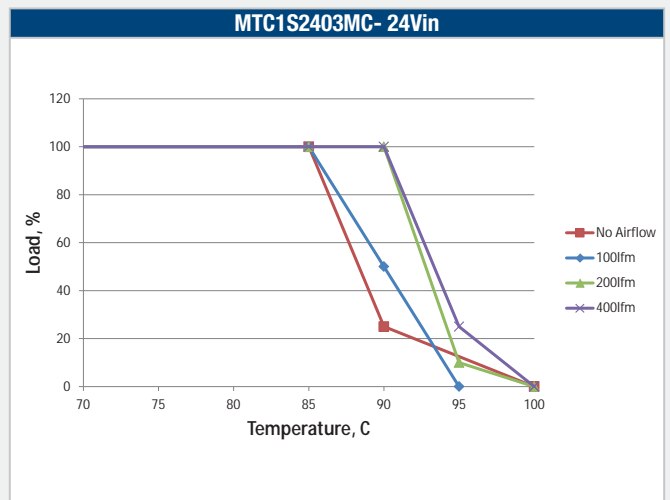
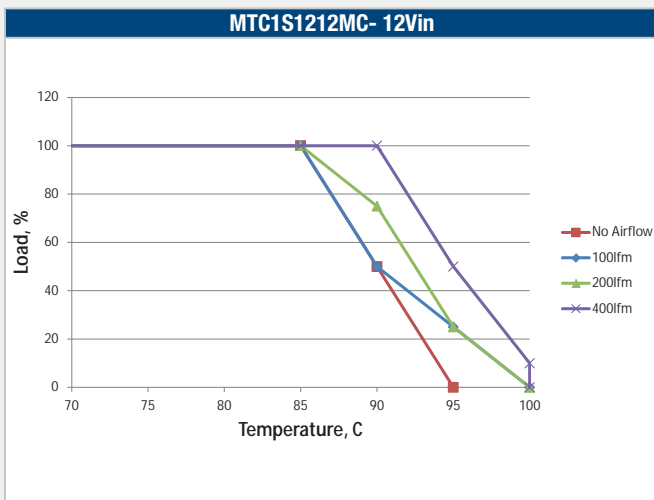
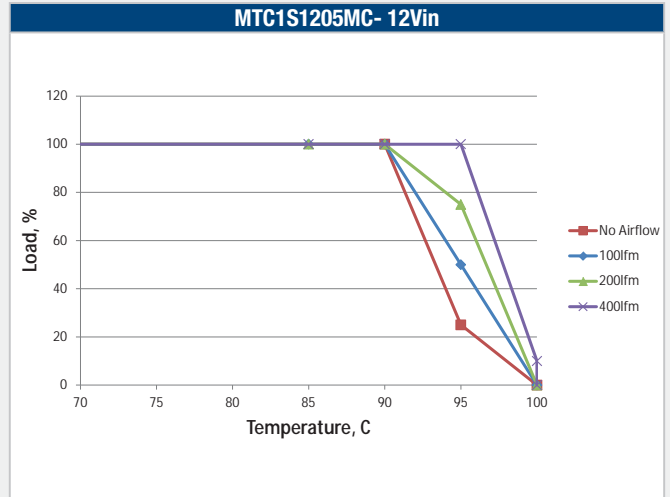
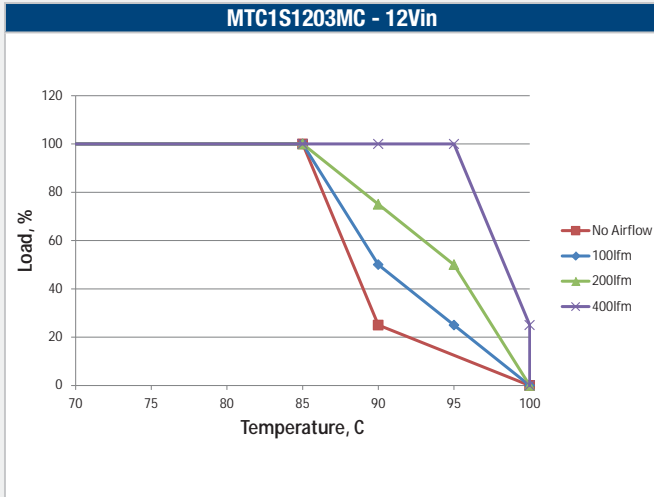

TEMPERATURE DERATING (Continued)

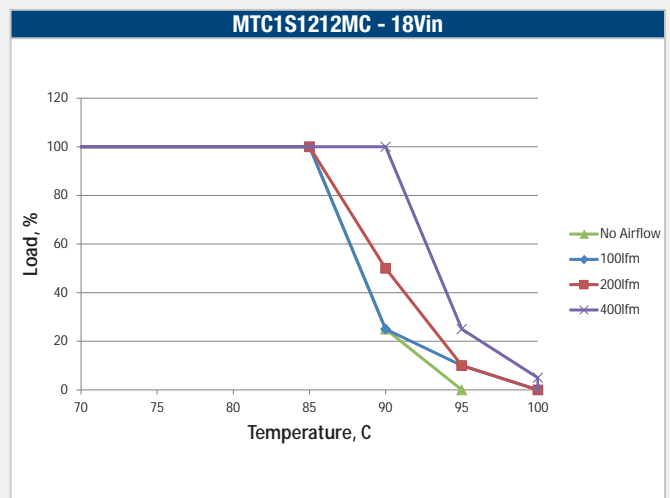
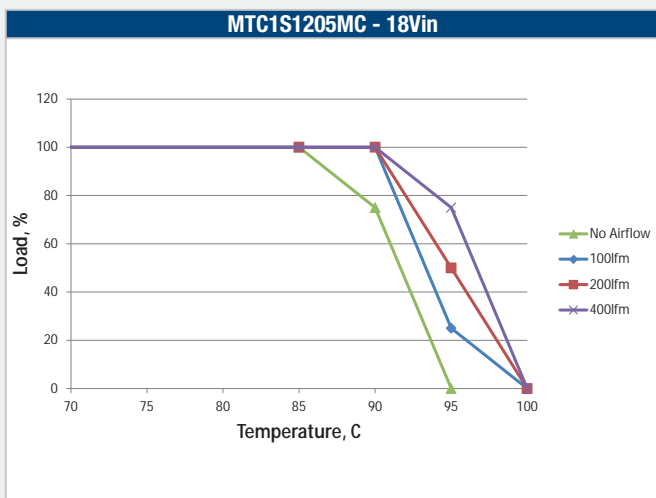
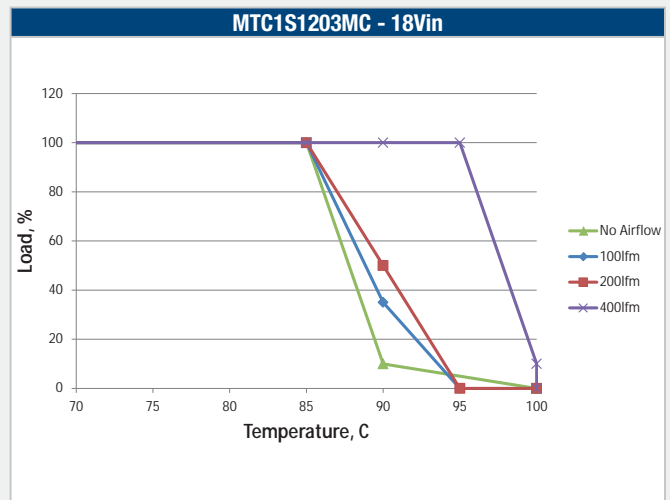
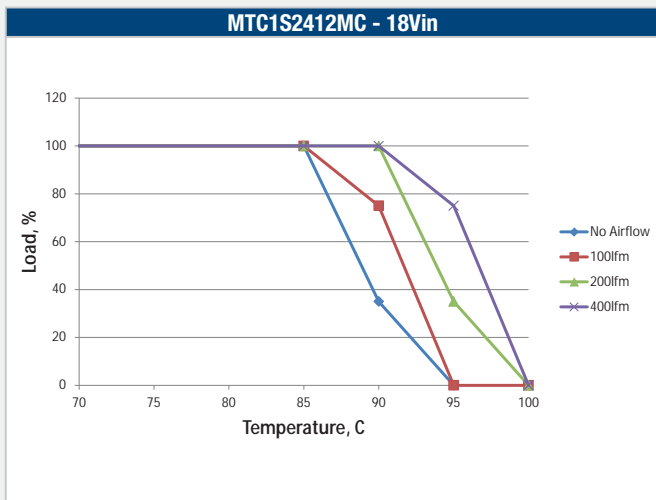
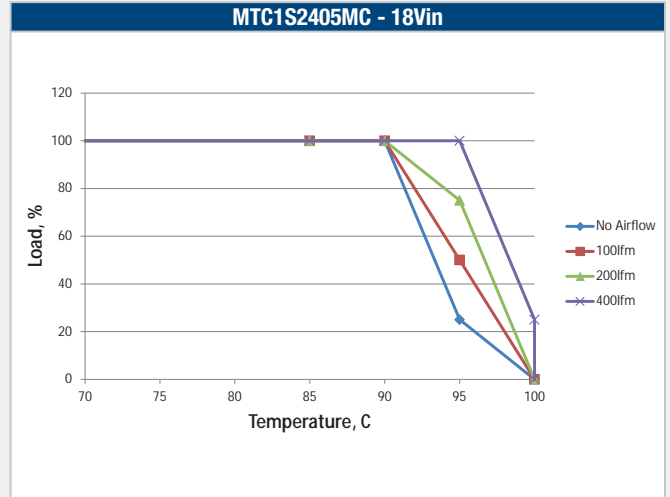
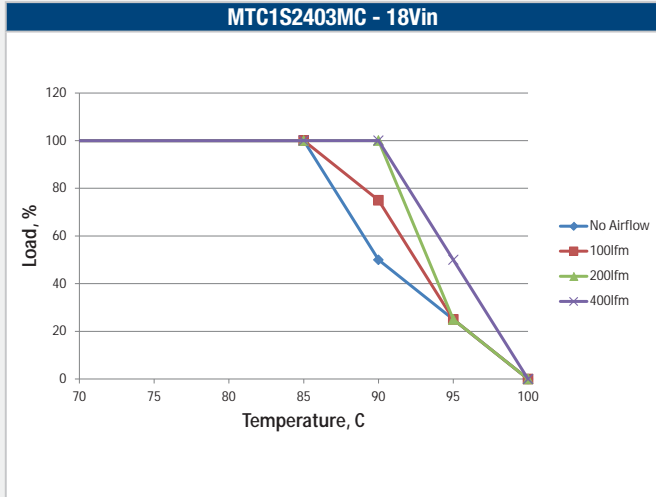

TEMPERATURE DERATING (Continued)

MTC1S2403MC- 36Vin

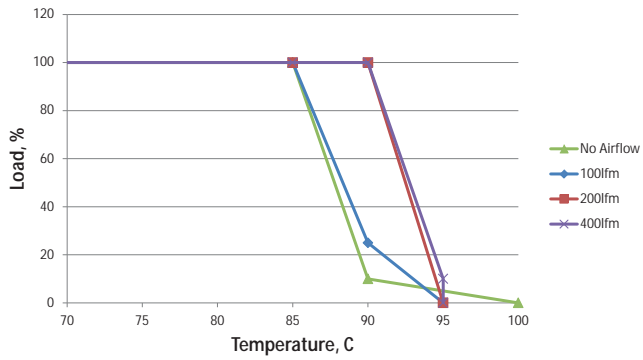

MTC1S2405MC- 36Vin

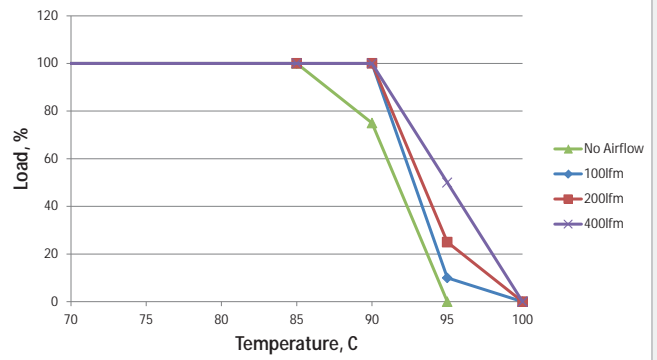

MTC1S2412MC- 36Vin

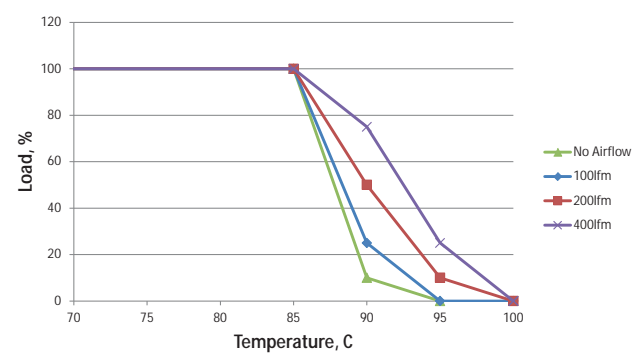

EMC FILTERING AND SPECTRA

FILTERING

The following table shows the additional input capacitor and input inductor typically required to meet EN 55022 Curve B Quasi-Peak EMC limit, as shown in the following plots. The following plots show positive and negative quasi peak and CISPR22 Average Limit B (pink line) and Quasi Peak Limit B (purple line) adherence limits. The below values are for guidance only and should be evaluated in the application circuit.

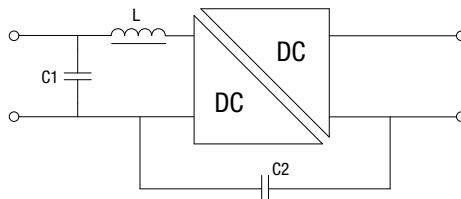

Part Number	Inductor			C1, μ F	Capacitor		
	L, μ H	SMD	Through Hole		Recommended Part Number	C2, pF	Recommended Part Number
MTC1S0503MC	2.2	84222C	13R222C	10 & 4.7	GRM31CR71E106KA12L & GCM21BR71C475KA73L	Not required	
MTC1S0505MC	2.2	84222C	13R222C	10	GRM31CR71E106KA12L	Not required	
MTC1S0505MC	4.7	84472C	13R472C	10	GRM31CR71E106KA12L	Not required	
MTC1S1203MC	6.8	84682C	13R682C	4.7	GRM21BC71E475KE11L	Not required	
MTC1S1205MC	4.7	84472C	13R472C	4.7	GRM21BC71E475KE11L	Not required	
MTC1S1205MC	4.7	84472C	13R472C	4.7	GRM21BC71E475KE11L	22	DK11XEA220K86RBH0
MTC1S2403MC	4.7	84472C	13R472C	10	GCM32EC71H106KA03L	47	DK11XEA470K86RBH01
MTC1S2405MC	4.7	84472C	13R472C	10	GCM32EC71H106KA03L	47	DK11XEA470K86RBH01
MTC1S2405MC	4.7	84472C	13R472C	10	GCM32EC71H106KA03L	Not required	

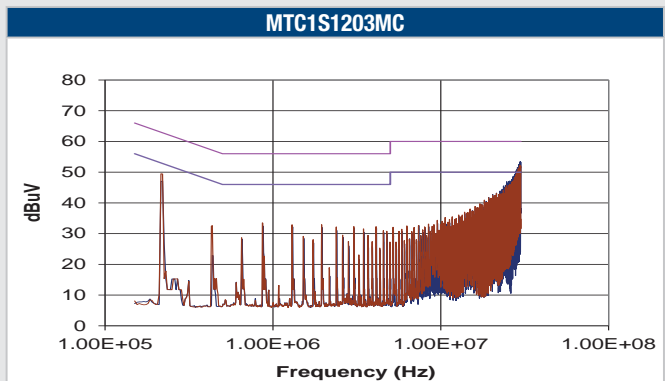
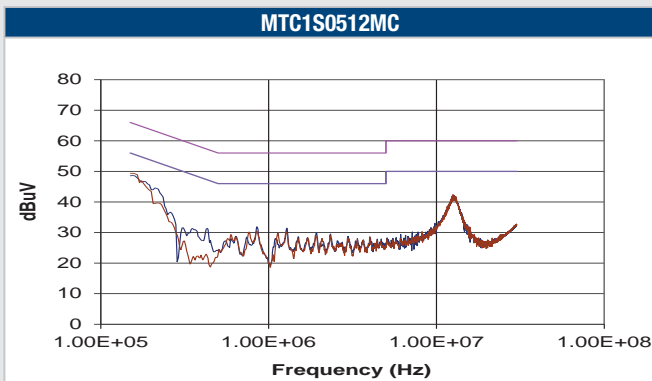
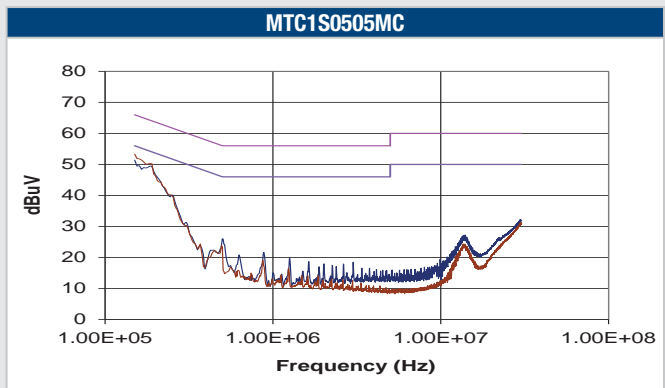
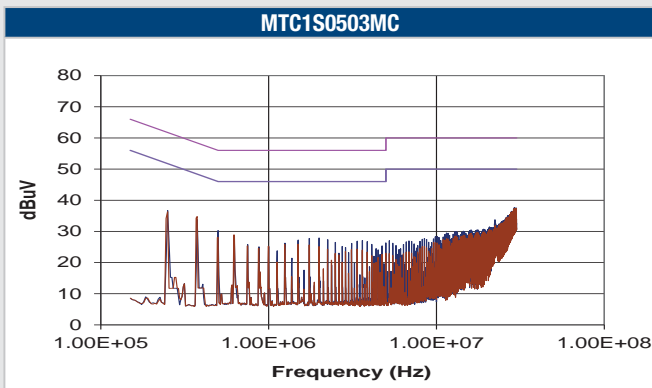

EMC FILTERING AND SPECTRA (Continued)

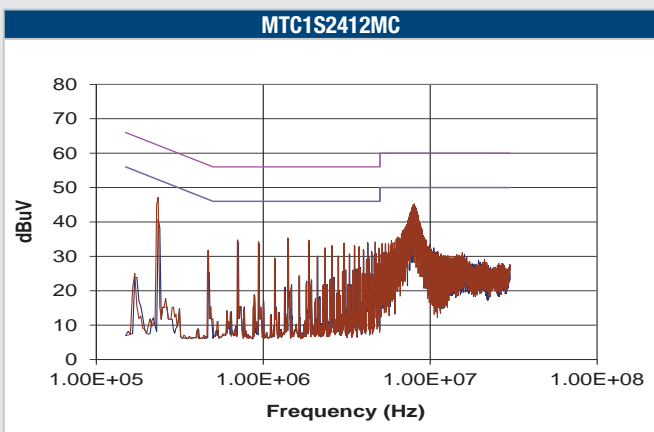
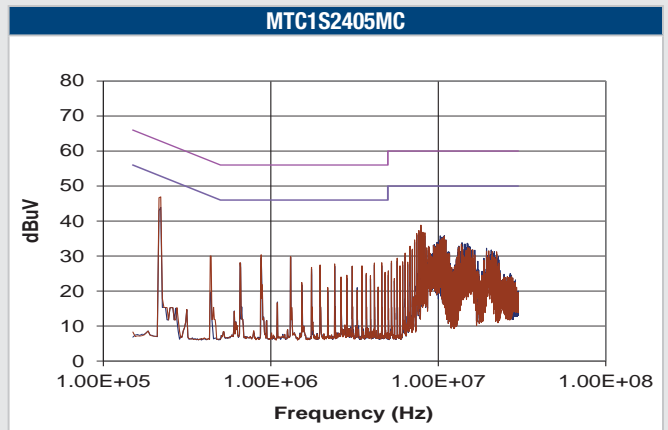
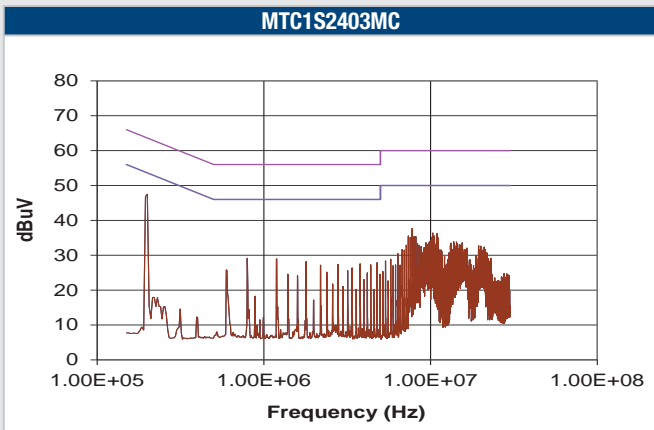
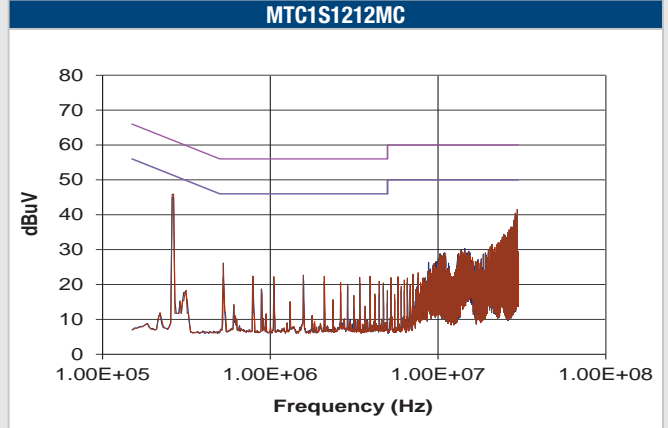
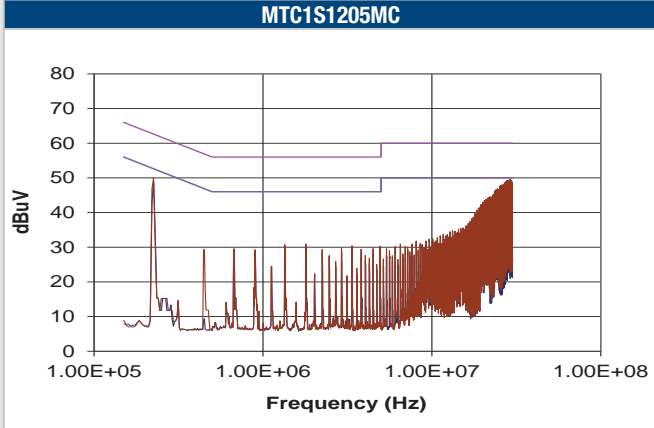

PACKAGE SPECIFICATIONS

Mechanical Dimensions

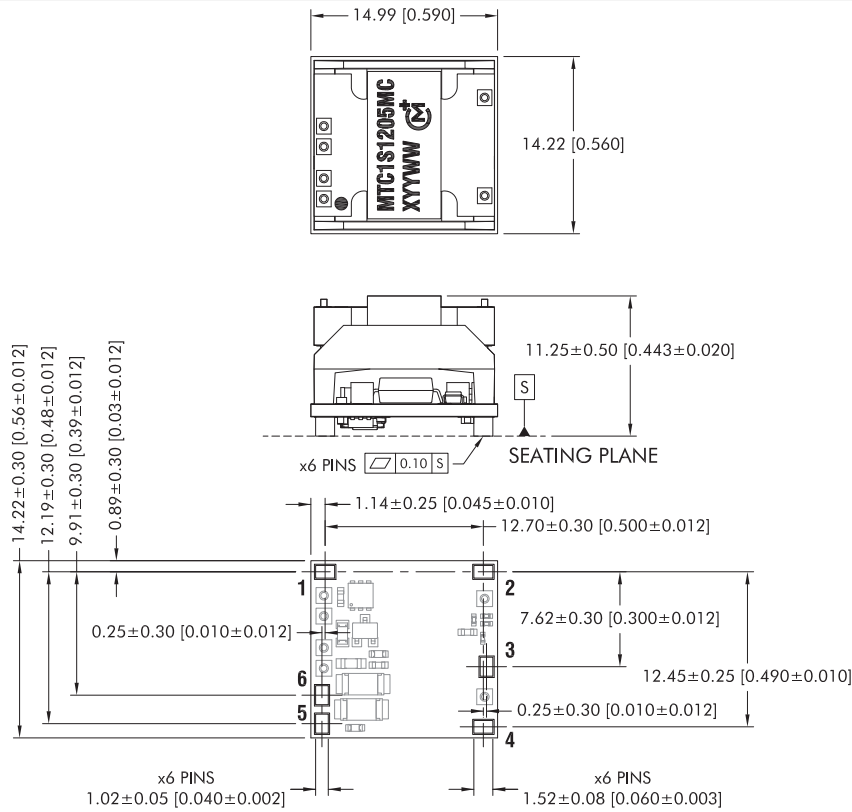

All dimensions in mm(inches), Controlling dimension is mm. Tolerances (unless otherwise stated) ±0.10(0.004).

Components shown for reference only

Weight: 3.6g (5Vin) 3.4g (all others)

Pin Connections

Pin	Function
1	+Vin
2	-Vout
3	Trim
4	+Vout
5	Ctrl
6	-Vin

Recommended Footprint Details

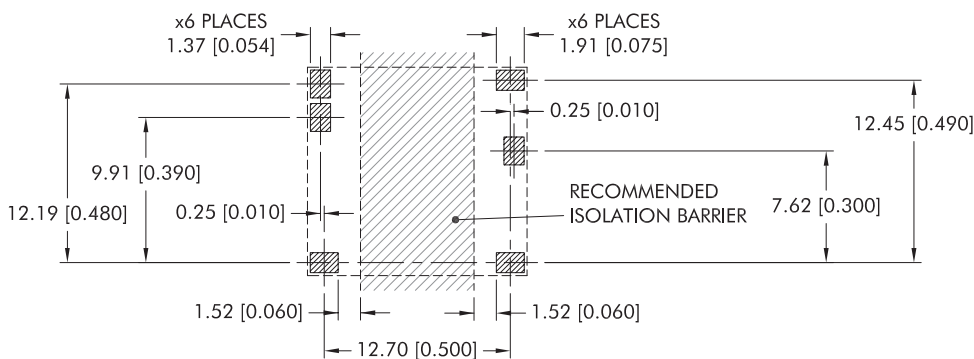

TAPE & REEL SPECIFICATIONS

REEL OUTLINE DIMENSIONS

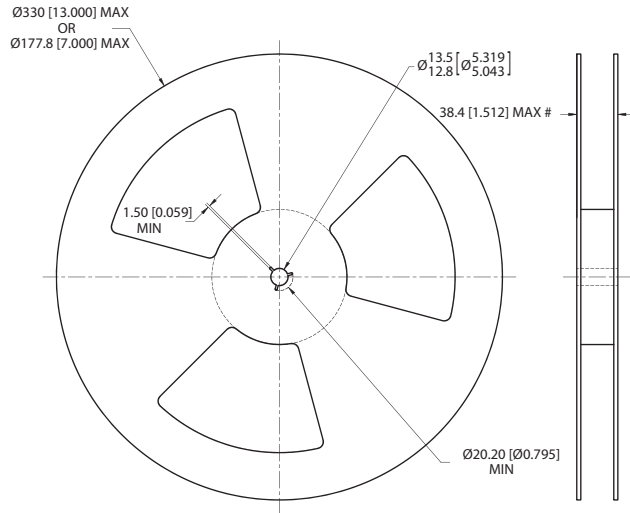

Tape & Reel specifications shall conform with current EIA-481 standard
 Unless otherwise stated all dimensions in mm (inches)
 Controlling dimension is mm
 # Measured at hub

REEL PACKAGING DETAILS

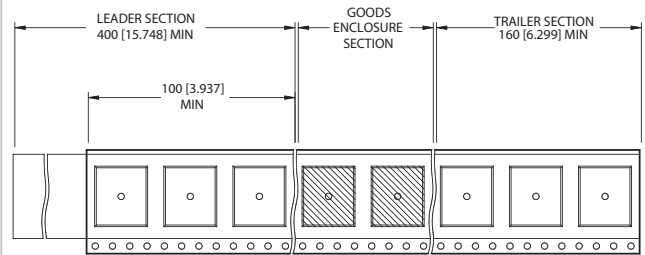

Carrier tape pockets shown are illustrative only - Refer to carrier tape diagram for actual pocket details.

Reel Quantity: 7" - 30 or 13" - 150

TAPE OUTLINE DIMENSIONS

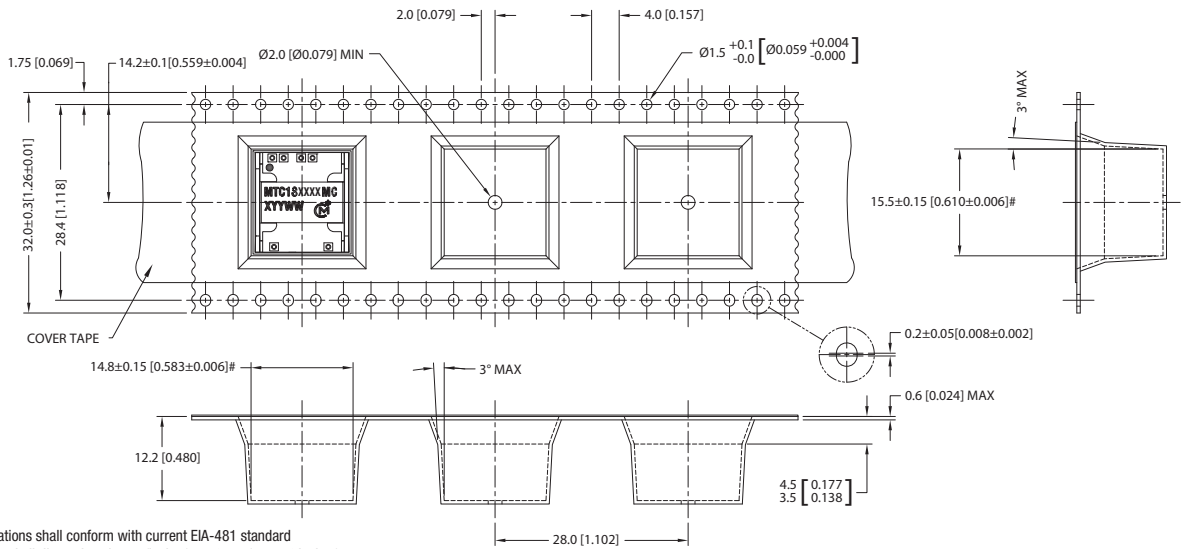

Tape & Reel specifications shall conform with current EIA-481 standard
 Unless otherwise stated all dimensions in mm (inches) ±0.1mm (±0.004 inches)
 Controlling dimension is mm
 Components shall be orientated within the carrier tape as indicated
 # Measured on a plane 0.3mm above the bottom pocket

DISCLAIMER

Unless otherwise stated in the datasheet, all products are designed for standard commercial and industrial applications and NOT for safety-critical and/or life-critical applications.

Particularly for safety-critical and/or life-critical applications, i.e. applications that may directly endanger or cause the loss of life, inflict bodily harm and/or loss or severe damage to equipment/property, and severely harm the environment, a prior explicit written approval from Murata is strictly required. Any use of Murata standard products for any safety-critical, life-critical or any related applications without any prior explicit written approval from Murata shall be deemed unauthorised use.

These applications include but are not limited to:

- Aircraft equipment
- Aerospace equipment
- Undersea equipment
- Power plant control equipment
- Medical equipment
- Transportation equipment (automobiles, trains, ships, etc.)
- Traffic signal equipment
- Disaster prevention / crime prevention equipment
- Data Processing equipment

Murata makes no express or implied warranty, representation, or guarantee of suitability, fitness for any particular use/purpose and/or compatibility with any application or device of the buyer, nor does Murata assume any liability whatsoever arising out of unauthorised use of any Murata product for the application of the buyer. The suitability, fitness for any particular use/purpose and/or compatibility of Murata product with any application or device of the buyer remain to be the responsibility and liability of the buyer.

Buyer represents and agrees that it has all the necessary expertise to create and implement safeguards that anticipate dangerous consequences of failures, monitor failures and their consequences, lessen the likelihood of failures that might cause harm, and take appropriate remedial actions. Buyer will fully indemnify and hold Murata, its affiliated companies, and its representatives harmless against any damages arising out of unauthorised use of any Murata products in any safety-critical and/or life-critical applications.

Remark: Murata in this section refers to Murata Manufacturing Company and its affiliated companies worldwide including, but not limited to, Murata Power Solutions.



This product is subject to the following [operating requirements](https://www.murata.com/en-eu/products/power/requirements) and the [Life and Safety Critical Application Sales Policy](https://www.murata.com/en-eu/products/power/requirements):

Refer to: <https://www.murata.com/en-eu/products/power/requirements>

Murata Power Solutions (Milton Keynes) Ltd. makes no representation that the use of its products in the circuits described herein, or the use of other technical information contained herein, will not infringe upon existing or future patent rights. The descriptions contained herein do not imply the granting of licenses to make, use, or sell equipment constructed in accordance therewith. Specifications are subject to change without notice. © 2021 Murata Power Solutions (Milton Keynes) Ltd.