

Customer Part:

Description

- 3.2 x 1.5mm SMD crystal in a ceramic package with a seam sealed metal lid, hermetically sealed.
- Model CFPX-217
- Model Issue number 5

Frequency Parameters

- Frequency 32.7680kHz
- Frequency Tolerance ±20.00ppm
- Tolerance Condition @ 25°C ±5°C
- Overtone Order Fundamental
- Ageing ±3ppm max in 1st year @ 25°C

Electrical Parameters

- Load Capacitance (CL) 6.00pF
- Shunt Capacitance (C0) 1.05pF typical
- Drive Level 1µW max
- ESR 70.00kΩ max

Environmental Parameters

- Storage Temperature Range: -55 to 125°C
- Drop: 100g dummy, 150cm drop (3 directions x 10 times) onto concrete
- Vibration: 1.5mm amplitude, 10Hz-500Hz, full sine wave or acceleration 10g, 1.5mins in 3 mutually perpendicular planes, duration 2hrs each plane

Manufacturing Details

- RoHS Terminations NiAu
- RoHS Reflow Temp 260°C max for 10s max

Compliance

- RoHS Status (2015/863/EU) Compliant
- REACH Status Compliant
- MSL Rating (JDEC-STD-033): Not Applicable

Packaging Details

- Pack Style: Reel Tape & reel in accordance with EIA-481-D
Pack Size: 3,000
- *Alternative packing option available*



Outline (mm)

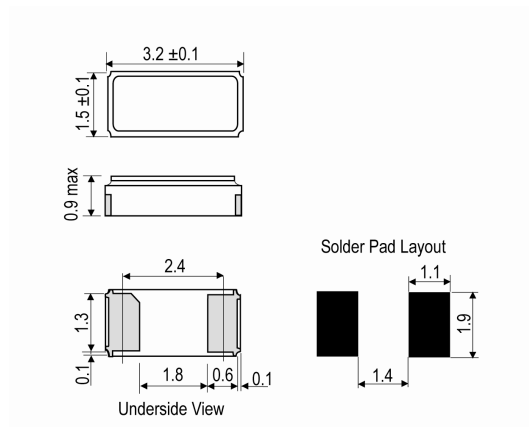

Typical Frequency Stability Characteristics

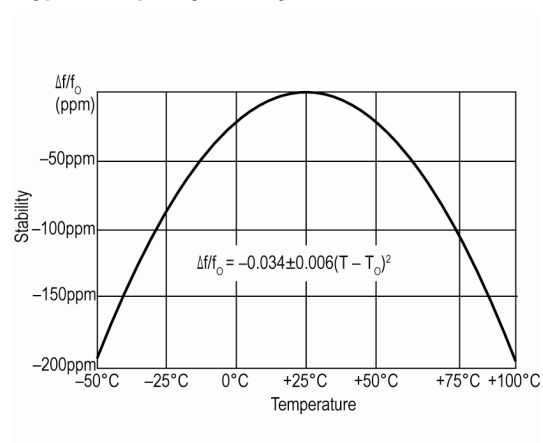

Sales Office Contact Details:

UK: +44 (0)1460 270200
Germany: 0800 1808 443

France: 0800 901 383
USA: +1.760.318.2824

Email: info@iqdfrequencyproducts.com
Web: www.iqdfrequencyproducts.com