

# Non EMC DIN-Based VectorPak™ Subracks

## Rack Components & Accessories



### Adapter Plates (Z-Rail Type)

Part No.	Description
AS1/2 (Pkg of 2)	Adapter plate for mounting DIN connectors directly onto subrack, 84 tapped holes (2.5mm x 4.5mm pitch) To be used without backplane

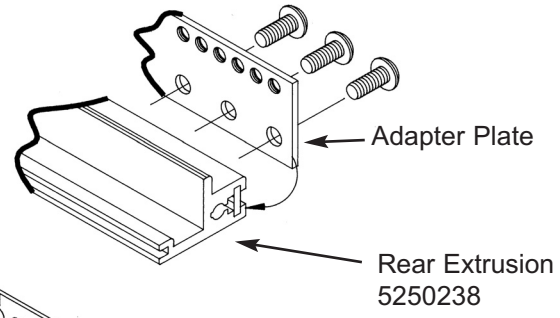

### Insulation Strips

Mounted between backplane and rear extrusion

Part No.	HP	Width
5250998-84	84	17.00" (431.8mm)

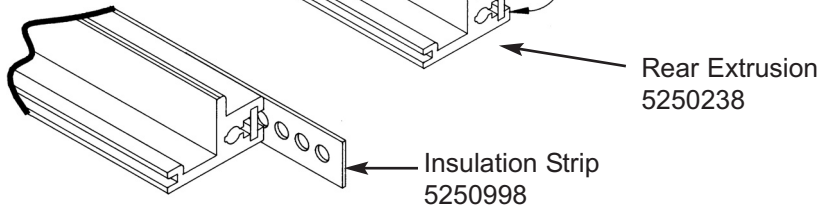

### Nut Strips

Threaded mounting holes spaced at 0.2" centers slide into extrusion grooves, can be used to anchor panels, cards or other components. Used on front & rear extrusions on all Vector DIN based metric subracks.

Part No.	HP	Width
5250268-84	84	17" (431.8mm)
5250268-63	63	12.8" (325.1mm)
5250268-42	42	8.6" (218.4mm)
5250268-21	21	4.4" (111.8mm)

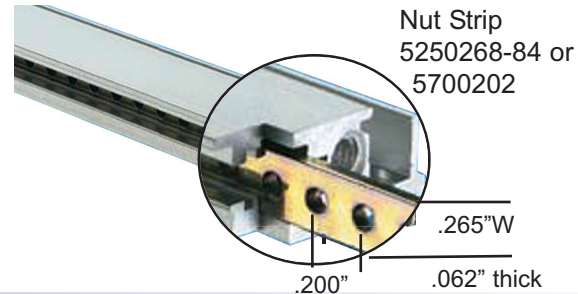

## Extrusions

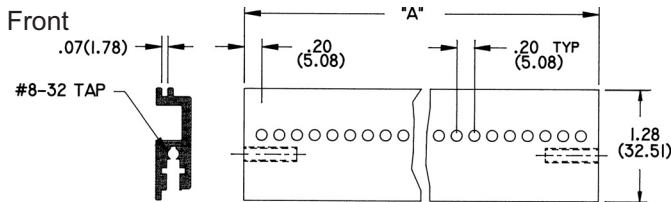

All extrusions available in any length

Part No.	HP	A
5250236-84	84	17.00" (431.8)
5250236-63	63	12.80" (325.8)
5250236-42	42	8.60" (218.4)
5250236-21	21	4.40" (11.8)

Pack of 12 8-32 screws, P/N HD94

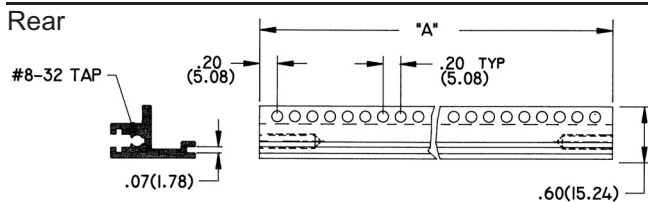

Part No.	HP	A
5250238-84	84	17.00" (431.8)
5250238-63	63	12.80" (325.8)
5250238-42	42	8.60" (218.4)
5250238-21	21	4.40" (11.8)

Pack of 12 8-32 screws, P/N HD94

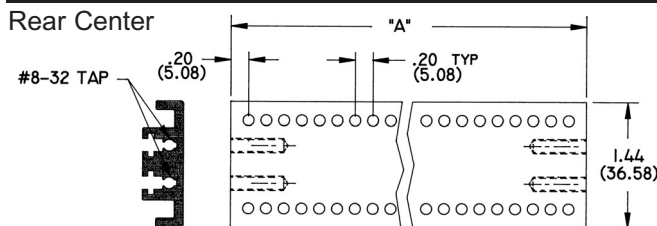

Part No.	HP	A
5250237-84	84	17.00" (431.8)
5250237-63	63	12.80" (325.8)
5250237-42	42	8.60" (218.4)
5250237-21	21	4.40" (11.8)

Pack of 12 8-32 screws, P/N HD94

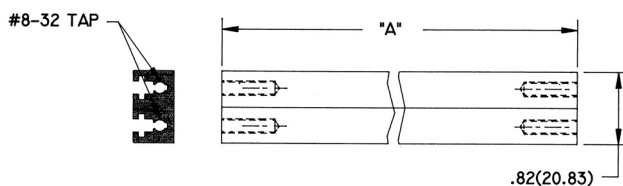

Part No.	HP	A
5250229-84	84	17.00" (431.8)
5250229-63	63	12.80" (325.8)
5250229-42	42	8.60" (218.4)
5250229-21	21	4.40" (11.8)

Pack of 12 8-32 screws, P/N HD94

Non EMC Subracks

