

Embedded DC-DC Converters Using ISL6526 and ISL6527 PWM Controller ICs

The ISL6526 and the ISL6527 provide power control and protection for applications requiring low voltage and high power. Both ICs can be biased from voltages between 3.3V and 5V. The ISL6526 and ISL6527 contain a high performance error amplifier, a high accuracy reference, a fixed 300kHz or 600kHz internal oscillator, over-current protection circuitry, and two MOSFET drivers for use in synchronous-rectified buck converters. Both the ISL6526 and the ISL6527 are capable of regulating the output voltage while the DC-DC converter is sinking current. The ISL6527 also allows for an external reference to be used. All these features are packaged in a small 14-lead SOIC or a 16-lead 5x5[mm] MLFP. More complete descriptions of the ISL6526 and the ISL6527 can be found in their respective datasheets [1, 2].

This application note details the ISL6526 and ISL6527 in DC-DC converters for applications requiring a tightly regulated, fixed output voltage. Low-cost applications requiring a DC-DC converter can benefit from one of the designs presented in this application note

ISL6526/27 Reference Designs

The ISL6526/27 evaluation board highlights the operation of the ISL6526 and ISL6527 ICs in an embedded application. There are five evaluation boards from which to choose.

Table 1 - Evaluation Boards

Board Name	Switching Frequency	IC	Package
ISL6526EVAL1	300kHz and 600kHz	ISL6526CB ISL6526ACB	14 ld SOIC
ISL6526EVAL2	300kHz	ISL6526CR	16 ld MLFP
ISL6527EVAL1	300kHz and 600kHz	ISL6527CB ISL6527ACB	14 ld SOIC
ISL6527EVAL2	600kHz	ISL6527ACR	16 ld MLFP

The ISL6526EVAL1 board is built with the ISL6526CB and shipped with an ISL6526ACB sample piece. Evaluation of the ISL6526CB can be performed immediately. If evaluation of the ISL6526ACB is desired, then it is a simple matter of replacing the controller. The ISL6527EVAL1 is shipped with the ISL6527CB and shipped with an ISL6527ACB sample piece. As with the ISL6526CB and ISL6526ACB, the parts are interchangeable.

The ISL6526EVAL2 and ISL6527EVAL2 are ready for evaluation without any modifications.

All evaluation boards have the same output filter, compensation components and MOSFETs. They are

configured for an output of 2.5V with a maximum load of 5A. The ISL6526 evaluation boards have a fixed output while the ISL6527 evaluation boards allow the use of a potentiometer to adjust the output voltage from 0.75V to 3.0V. Unless otherwise noted, this application note assumes that the output of the ISL6527 evaluation board is 2.5V.

Quick Start Evaluation

The evaluation board is shipped 'ready to use' right from the box. The board accepts a range of input voltages from 3.3V to 5V from a standard power supply. The output can be exercised through an external load.

There are posts available on the board for introducing power to the board and also for drawing current from the regulated output. Three probe points are also available for use. These probe points provide Kelvin connections to the CPVOUT(TP3) and CT1(TP1) pins on both the ISL6526 and ISL6527. The ENABLE pin on the ISL6526 and the REF_IN pin on the ISL6527 can be probed from TP2.

Recommended Test Equipment

To test the functionality of the ISL6526 or ISL6527, the following equipment is recommended:

- An adjustable 0 - 5V, 5A capable bench power supply
- An electronic load
- Four channel oscilloscope with probes
- Precision digital multimeter

Power and Load Connections

There are 2 sets of terminals that are used to supply the input voltage and load the output.

INPUT VOLTAGE

Connect the positive lead of the adjustable bench power supply to the 3.3V post (J1). Connect the ground lead of the supply to GND post (J2).

OUTPUT LOADING - SOURCING CURRENT

Connect the positive terminal of the load to the VOUT post (J3). Connect the return terminal of the same load to the GND post (J4).

OUTPUT LOADING - SINKING CURRENT

CAUTION: The return terminal of the load must float for this to work properly.

To observe the output while the regulator sinks current, connect the positive terminal of the load to the 3.3V post

(J1). Connect the return terminal of the same load to the V_{OUT} post (J3).

Startup

There are two distinct start up methods for both the ISL6526 and ISL6527 regulators. The first method is invoked through the application of power to the IC. The soft-start feature allows for a controlled rise of the output once the Power On Reset (POR) threshold of the input voltage has been reached. Figure 1 shows the start up profile of the regulator in relation to the start up of the 3.3V input supply and the bias supply generated by the charge pump. Both the ISL6526 and ISL6527, whether switching at 300 or 600kHz, will have the same start up profile as shown in Figure 1.

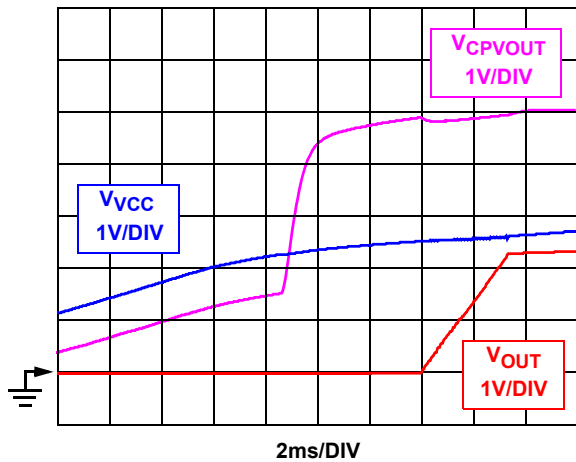

FIGURE 1. START UP FROM POR

The second method of start up is through the use of the Enable/Shutdown feature. Holding the ENABLE pin on the ISL6526 or the OCSET/SD pin on the ISL6527 below 0.8V will disable the regulator by forcing both the upper and lower MOSFETs off. Releasing the respective pin allows the regulator to start up. Figure 2 shows the start up profile with this method.

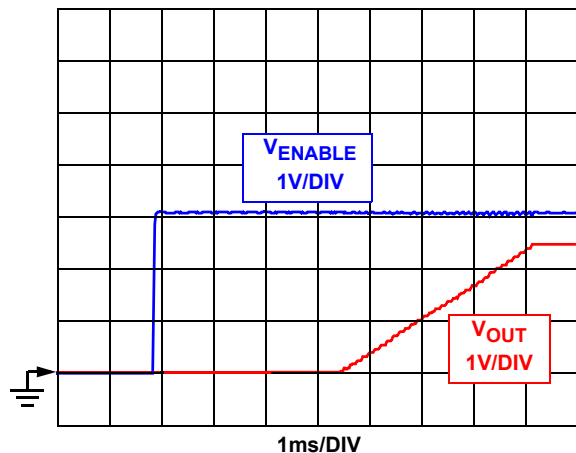

FIGURE 2. START UP FROM SHUT DOWN

Shutdown

As discussed in the previous section, if the OCSET/SD pin or ENABLE pin is pulled down and held below 0.8V, the regulator will be turned off. The MOSFET gates are immediately pulled low. Figure 3 shows the shutdown profile of the regulator under full load.

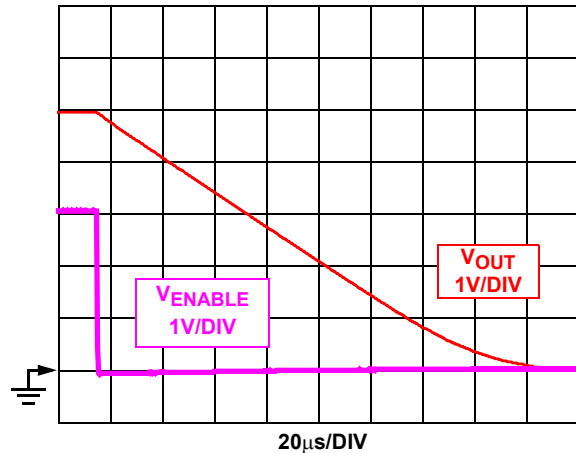

FIGURE 3. SHUTDOWN WITH FULL LOAD (ISL6526)

ISL6527 Input Reference

A distinguishing feature of the ISL6527 is that the reference used to regulate the output is provided from an external source. This allows the converter to track the output of another regulator at any desired ratio or amplify a small signal. Figure 4 illustrates the tracking and power amplification ability of the ISL6527 with a sinusoidal reference. Figure 4 also illustrates the startup profile.

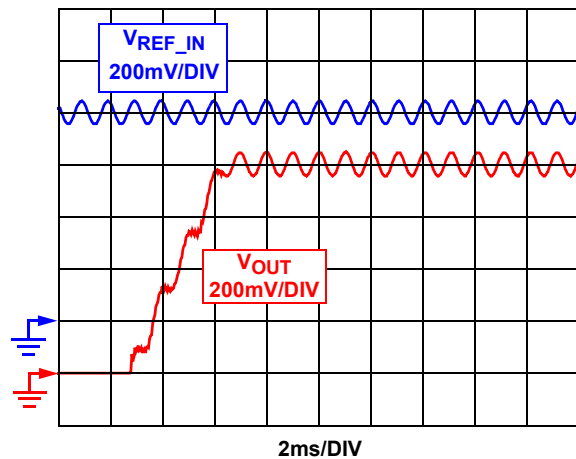

FIGURE 4. SMALL SIGNAL POWER AMPLIFICATION

Ripple Voltage

Figure 5 shows the ripple voltage on the output of the regulator. The ripple voltages shown are for both the ISL6526 and ISL6527 ICs running at either 300 or 600kHz.

Transient Performance

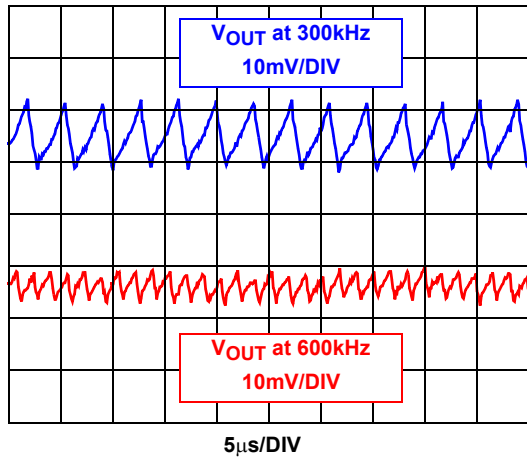

FIGURE 5. OUTPUT RIPPLE VOLTAGE

Figures 6 and 7 show the response of the output when subjected to sourcing and sinking transient loading, respectively.

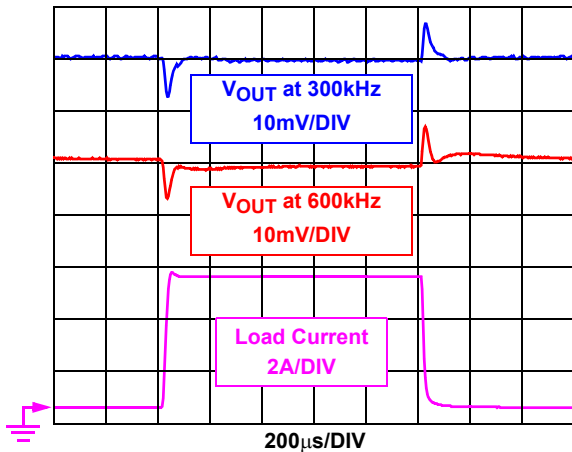

FIGURE 6. SOURCING TRANSIENT

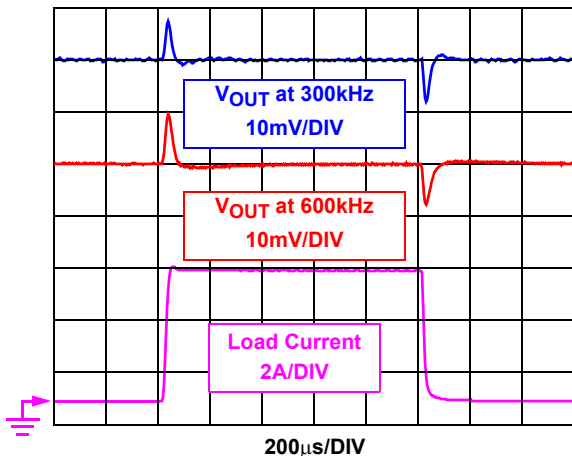

FIGURE 7. SINKING TRANSIENT

Lossless Output Voltage Droop

Droop is an intentional sag in the output voltage that is proportional to the output current. Although not necessary for proper circuit operation, utilizing droop allows the dynamic regulation to be improved by taking advantage of static regulation requirements and expanding the available headroom for transient edge output excursions. In practical applications that are compared to a non-droop implementation, the droop implementation requires fewer output capacitors or better regulation with the same type and number of output capacitors.

By moving the regulation point ahead of the output inductor (at the PHASE node), droop becomes equal to the average voltage drop across the output inductor's DC resistance as well as any distributed resistance. The droop circuitry is simply an RC low pass filter placed across the output inductor and its corresponding DCR have. The design must be careful to include any parasitic impedances of the PC board if the DCR of the inductor is very low.

The ISL6526/27 evaluation board does not have any component footprints that would allow an implementation of droop. This section is included in this application note as a guideline in the event that droop is necessary in a design utilizing the ISL6526 or ISL6527. Figure 8 shows a schematic of the power stage and Type III compensation network of an ISL6526/27 regulator with droop. The droop circuitry is

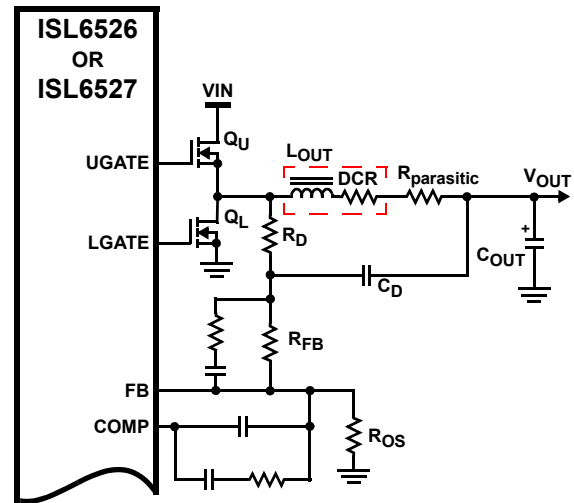

FIGURE 8. DROOP IMPLEMENTATION

represented by resistor R_D and capacitor C_D . The output of this low pass filter is fed directly into the feedback compensation network of the regulator. To insure symmetric output voltage excursions about the nominal voltage in response to load transients, the output voltage should be programmed to be above the nominal level by half the calculated droop.

A properly designed droop implementation will have the time constant of the RC filter equal to or very close to the time constant of the output inductor.

$$\tau = \frac{L_{out}}{DCR + R_{parasitic}} = (R_D \parallel R_{FB}) \cdot C_D$$

Note that the impedance portion of the time constant calculation for the RC filter includes the parallel combination of the filter resistor, R_D , and the feedback resistor, R_{FB} . Since the regulation point is now located at the phase node, and a resistor, R_D , is being added to the DC path for regulation, then the offset resistor, R_{OS} , must be adjusted.

$$R_{OS} = \left(\frac{V_{REF}}{V_{NOMINAL} + \frac{1}{2} \cdot I_{O(max)} \cdot DCR - V_{REF}} \right) \cdot (R_{FB} + R_D)$$

Where: $V_{REF} = 0.8V$ for ISL6526
 $V_{REF} =$ External Reference for ISL6527

Figure 9 shows the output voltage of the converter with the droop circuitry added.

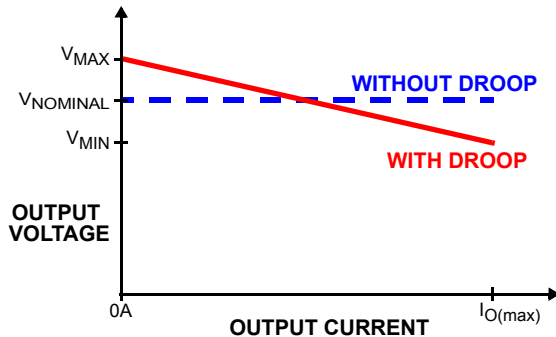

FIGURE 9. OUTPUT VOLTAGE DROOP

With the proper selection of the components used in the RC filter across the inductor, the frequency response of the system is only minimally affected and the compensation network does not need to be recalculated.

Efficiency

The ISL6526 and ISL6527 regulators allow for highly efficient systems. The efficiency of the evaluation board in is shown in Figure 10. The efficiencies of the converter for both sinking and sourcing current are identical.

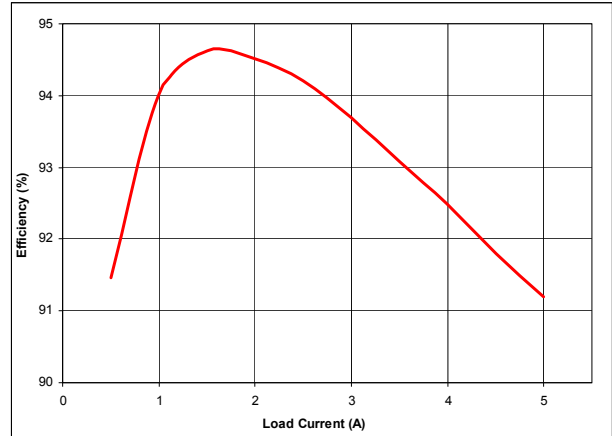

FIGURE 10. EFFICIENCY - SINKING AND SOURCING CURRENT

Conclusion

The ISL6526 and ISL6527 are versatile PWM controllers. Compact and highly efficient regulators can be implemented with either IC. Both ICs offer small footprints and features which make them an ideal for many low voltage power solutions.

References

For Intersil documents available on the web, see <http://www.intersil.com/>

- [1] *ISL6526 Data Sheet*, Intersil Corporation, File No. FN9055
- [2] *ISL6527 Data Sheet*, Intersil Corporation, File No. FN9056

Evaluation Board Schematic

NOTE: All evaluation boards share the same schematic.

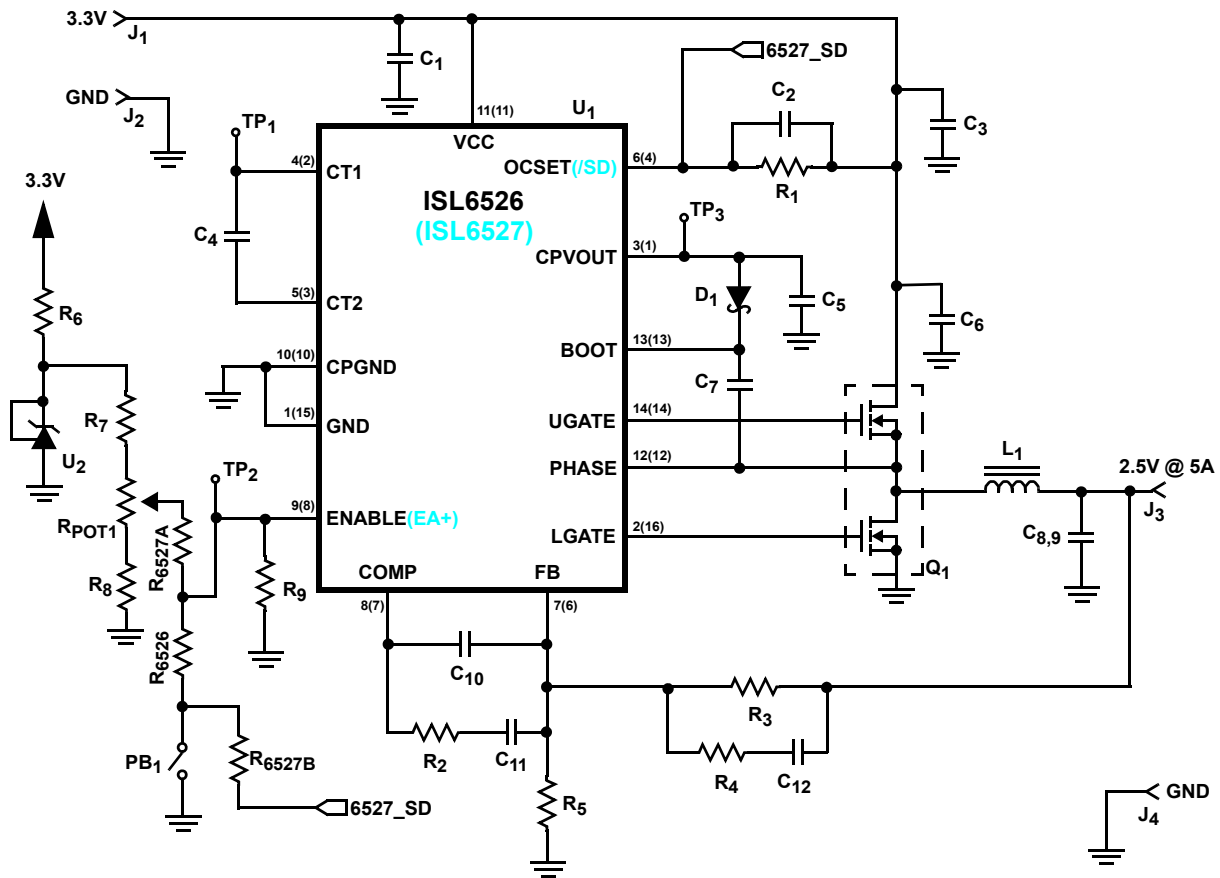

Pin numbers are designated as follows: The first number is the SOIC pin number.
The proceeding number in parentheses is the MLFP pin number.

Table 2 - Evaluation Board Specific Bill of Material

Ref Des	Description	Vendor	Vendor P/N	QTY
ISL6526EVAL1 Evaluation Board				
U1	ISL6526 300kHz Synchronous Buck PWM Controller - SOIC	Intersil	ISL6526CB	1
R6526	Zero Ohm Jumper	Various	---	1
R6527A,R6527B	Unpopulated Zero Ohm Jumper	Various	---	0
---	ISL6526A 600kHz Synchronous Buck PWM Controller - SOIC	Intersil	ISL6526ACB	1
The additional IC is bagged and tagged and shipped with the assembled evaluation board				
ISL6526EVAL2 Evaluation Board				
U1	ISL6526 300kHz Synchronous Buck PWM Controller - MLFP	Intersil	ISL6526CR	1
R6526	Zero Ohm Jumper	Various	---	1
R6527A,R6527B	Unpopulated Zero Ohm Jumper	Various	---	0
ISL6527EVAL1 Evaluation Board				
U1	ISL6527 300kHz Synchronous Buck PWM Controller - SOIC	Intersil	ISL6527CB	1
R6526	Unpopulated Zero Ohm Jumper	Various	---	0
R6527A,R6527B	Unpopulated Zero Ohm Jumper	Various	---	2
---	ISL6527A 600kHz Synchronous Buck PWM Controller - SOIC	Intersil	ISL6527ACB	1
The additional IC is bagged and tagged and shipped with the assembled evaluation board				

Table 2 - Evaluation Board Specific Bill of Material (Continued)

Ref Des	Description	Vendor	Vendor P/N	QTY
ISL6527EVAL2 Evaluation Board				
U1	ISL6527A 600kHz Synchronous Buck PWM Controller - MLFP	Intersil	ISL6527ACR	1
R6526	Unpopulated Zero Ohm Jumper	Various	---	0
R6527A,R6527B	Zero Ohm Jumper	Various	---	2

Table 3 - Evaluation Board Common Bill of Material

Ref Des	Description	Vendor	Vendor P/N	QTY
C1,C7	0.1 μ F Capacitor, 0603	Various	---	2
C2	1000pF Capacitor, 0603	Various	---	1
C3,C8,C9	150 μ F Capacitor	Panasonic	EEF-UE0J151R	3
C4	0.22 μ F Capacitor, 0805	Various	---	1
C5	10 μ F Capacitor	Various	---	1
C6	1 μ F Capacitor, 0805	Various	---	1
C10	33pF Capacitor, 0603	Various	---	1
C11	5600pF Capacitor, 0603	Various	---	1
C12	8200pF Capacitor, 0603	Various	---	1
D1	Diode, 30mA, 30V	Digikey	MA732	1
L1	1 μ H Inductor	Panasonic	ETQP6F1R0SFA	1
Q1	Dual MOSFET, 8 Pin SOIC	Fairchild	ITF86110DK8	1
R1	9.76k Ω 1% Resistor, 0603	Various	---	1
R2	6.49k Ω 1% Resistor, 0603	Various	---	1
R3	2.26k Ω 1% Resistor, 0603	Various	---	1
R4	124 Ω 1% Resistor, 0603	Various	---	1
R5	1.07k Ω 1% Resistor, 0603	Various	---	1
R6	1.33k Ω 1% Resistor, 0603	Various	---	1
R7	61.9k Ω 1% Resistor, 0603	Various	---	1
R8	13.3k Ω 1% Resistor, 0603	Various	---	1
R9	100k Ω 1% Resistor, 0603	Various	---	1
RPOT1	25 Turn Potentiometer 0 Ω to 50k Ω	Digikey	3299Y-503-ND	1
PB1	Pushbutton, miniature	Digikey	P8007S-ND	1
U2	Adjustable Precision Zener Shunt Regulator	National	LM431CCM3/N1B	1
TP1,TP2,TP3	Test Points	Digikey	5002K-ND	3
J1,2,3,4	Test Points	Keystone	1514-2	4

Board Description - MLFP

Silk Screen

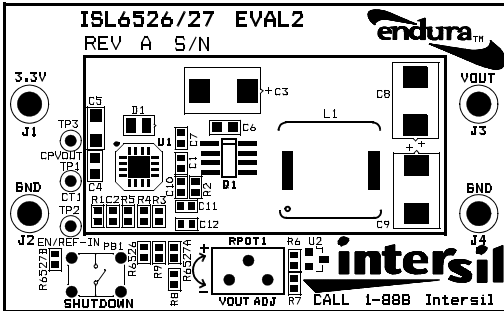

Top Layer

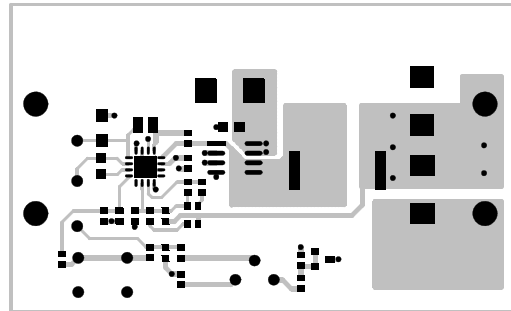

Ground Layer

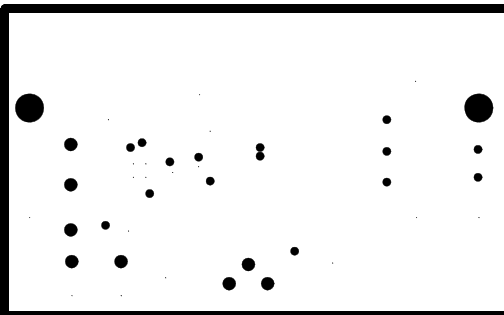

Power Layer

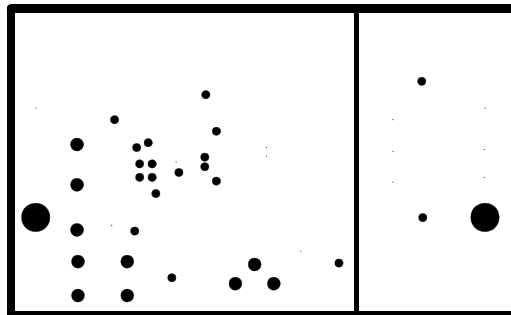

Bottom Layer

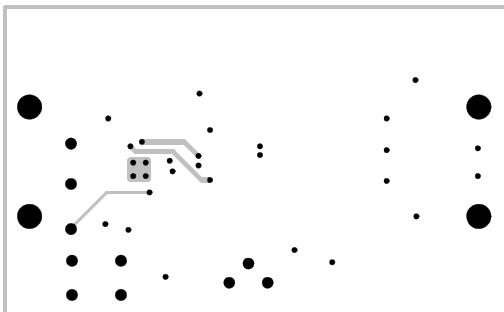

Board Description - SOIC

Silk Screen

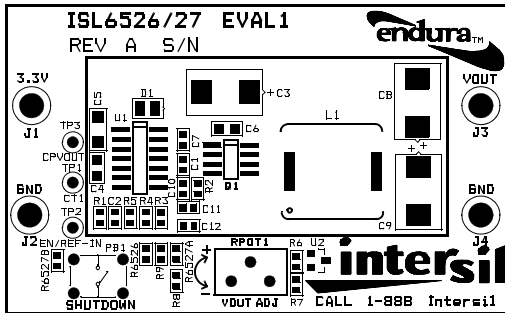

Notice

1. Descriptions of circuits, software and other related information in this document are provided only to illustrate the operation of semiconductor products and application examples. You are fully responsible for the incorporation or any other use of the circuits, software, and information in the design of your product or system. Renesas Electronics disclaims any and all liability for any losses and damages incurred by you or third parties arising from the use of these circuits, software, or information.
 2. Renesas Electronics hereby expressly disclaims any warranties against and liability for infringement or any other claims involving patents, copyrights, or other intellectual property rights of third parties, by or arising from the use of Renesas Electronics products or technical information described in this document, including but not limited to, the product data, drawings, charts, programs, algorithms, and application examples.
 3. No license, express, implied or otherwise, is granted hereby under any patents, copyrights or other intellectual property rights of Renesas Electronics or others.
 4. You shall not alter, modify, copy, or reverse engineer any Renesas Electronics product, whether in whole or in part. Renesas Electronics disclaims any and all liability for any losses or damages incurred by you or third parties arising from such alteration, modification, copying or reverse engineering.
 5. Renesas Electronics products are classified according to the following two quality grades: "Standard" and "High Quality". The intended applications for each Renesas Electronics product depends on the product's quality grade, as indicated below.
"Standard": Computers; office equipment; communications equipment; test and measurement equipment; audio and visual equipment; home electronic appliances; machine tools; personal electronic equipment; industrial robots; etc.
"High Quality": Transportation equipment (automobiles, trains, ships, etc.); traffic control (traffic lights); large-scale communication equipment; key financial terminal systems; safety control equipment; etc.
Unless expressly designated as a high reliability product or a product for harsh environments in a Renesas Electronics data sheet or other Renesas Electronics document, Renesas Electronics products are not intended or authorized for use in products or systems that may pose a direct threat to human life or bodily injury (artificial life support devices or systems; surgical implantations; etc.), or may cause serious property damage (space system; undersea repeaters; nuclear power control systems; aircraft control systems; key plant systems; military equipment; etc.). Renesas Electronics disclaims any and all liability for any damages or losses incurred by you or any third parties arising from the use of any Renesas Electronics product that is inconsistent with any Renesas Electronics data sheet, user's manual or other Renesas Electronics document.
 6. When using Renesas Electronics products, refer to the latest product information (data sheets, user's manuals, application notes, "General Notes for Handling and Using Semiconductor Devices" in the reliability handbook, etc.), and ensure that usage conditions are within the ranges specified by Renesas Electronics with respect to maximum ratings, operating power supply voltage range, heat dissipation characteristics, installation, etc. Renesas Electronics disclaims any and all liability for any malfunctions, failure or accident arising out of the use of Renesas Electronics products outside of such specified ranges.
 7. Although Renesas Electronics endeavors to improve the quality and reliability of Renesas Electronics products, semiconductor products have specific characteristics, such as the occurrence of failure at a certain rate and malfunctions under certain use conditions. Unless designated as a high reliability product or a product for harsh environments in a Renesas Electronics data sheet or other Renesas Electronics document, Renesas Electronics products are not subject to radiation resistance design. You are responsible for implementing safety measures to guard against the possibility of bodily injury, injury or damage caused by fire, and/or danger to the public in the event of a failure or malfunction of Renesas Electronics products, such as safety design for hardware and software, including but not limited to redundancy, fire control and malfunction prevention, appropriate treatment for aging degradation or any other appropriate measures. Because the evaluation of microcomputer software alone is very difficult and impractical, you are responsible for evaluating the safety of the final products or systems manufactured by you.
 8. Please contact a Renesas Electronics sales office for details as to environmental matters such as the environmental compatibility of each Renesas Electronics product. You are responsible for carefully and sufficiently investigating applicable laws and regulations that regulate the inclusion or use of controlled substances, including without limitation, the EU RoHS Directive, and using Renesas Electronics products in compliance with all these applicable laws and regulations. Renesas Electronics disclaims any and all liability for damages or losses occurring as a result of your noncompliance with applicable laws and regulations.
 9. Renesas Electronics products and technologies shall not be used for or incorporated into any products or systems whose manufacture, use, or sale is prohibited under any applicable domestic or foreign laws or regulations. You shall comply with any applicable export control laws and regulations promulgated and administered by the governments of any countries asserting jurisdiction over the parties or transactions.
 10. It is the responsibility of the buyer or distributor of Renesas Electronics products, or any other party who distributes, disposes of, or otherwise sells or transfers the product to a third party, to notify such third party in advance of the contents and conditions set forth in this document.
 11. This document shall not be reprinted, reproduced or duplicated in any form, in whole or in part, without prior written consent of Renesas Electronics.
 12. Please contact a Renesas Electronics sales office if you have any questions regarding the information contained in this document or Renesas Electronics products.
- (Note 1) "Renesas Electronics" as used in this document means Renesas Electronics Corporation and also includes its directly or indirectly controlled subsidiaries.
(Note 2) "Renesas Electronics product(s)" means any product developed or manufactured by or for Renesas Electronics.

(Rev.4.0-1 November 2017)



SALES OFFICES

Renesas Electronics Corporation

<http://www.renesas.com>

Refer to "<http://www.renesas.com/>" for the latest and detailed information.

Renesas Electronics America Inc.
1001 Murphy Ranch Road, Milpitas, CA 95035, U.S.A.
Tel: +1-408-432-8888, Fax: +1-408-434-5351

Renesas Electronics Canada Limited
9251 Yonge Street, Suite 8309 Richmond Hill, Ontario Canada L4C 9T3
Tel: +1-905-237-2004

Renesas Electronics Europe Limited
Dukes Meadow, Millboard Road, Bourne End, Buckinghamshire, SL8 5FH, U.K
Tel: +44-1628-651-700, Fax: +44-1628-651-804

Renesas Electronics Europe GmbH
Arcadiastrasse 10, 40472 Düsseldorf, Germany
Tel: +49-211-6503-0, Fax: +49-211-6503-1327

Renesas Electronics (China) Co., Ltd.
Room 1709 Quantum Plaza, No.27 ZhichunLu, Haidian District, Beijing, 100191 P. R. China
Tel: +86-10-8235-1155, Fax: +86-10-8235-7679

Renesas Electronics (Shanghai) Co., Ltd.
Unit 301, Tower A, Central Towers, 555 Langao Road, Putuo District, Shanghai, 200333 P. R. China
Tel: +86-21-2226-0888, Fax: +86-21-2226-0999

Renesas Electronics Hong Kong Limited
Unit 1601-1611, 16/F., Tower 2, Grand Century Place, 193 Prince Edward Road West, Mongkok, Kowloon, Hong Kong
Tel: +852-2265-6688, Fax: +852-2886-9022

Renesas Electronics Taiwan Co., Ltd.
13F, No. 363, Fu Shing North Road, Taipei 10543, Taiwan
Tel: +886-2-8175-9600, Fax: +886-2-8175-9670

Renesas Electronics Singapore Pte. Ltd.
80 Bendemeer Road, Unit #06-02 Hyflux Innovation Centre, Singapore 339949
Tel: +65-6213-0200, Fax: +65-6213-0300

Renesas Electronics Malaysia Sdn.Bhd.
Unit 1207, Block B, Menara Amcorp, Amcorp Trade Centre, No. 18, Jln Persiaran Barat, 46050 Petaling Jaya, Selangor Darul Ehsan, Malaysia
Tel: +60-3-7955-9390, Fax: +60-3-7955-9510

Renesas Electronics India Pvt. Ltd.
No.777C, 100 Feet Road, HAL 2nd Stage, Indiranagar, Bangalore 560 038, India
Tel: +91-80-67208700, Fax: +91-80-67208777

Renesas Electronics Korea Co., Ltd.
17F, KAMCO Yangjae Tower, 262, Gangnam-daero, Gangnam-gu, Seoul, 06265 Korea
Tel: +82-2-558-3737, Fax: +82-2-558-5338