

### Features:

- Frequency Range: 12.5 – 15.5 GHz
- P1dB: 32 dBm
- IM3 Level -44dBc @Po=20dBm/tone
- Gain: 23.5 dB
- Vdd =4 to 6 V
- Ids = 1200 to 2500 mA
- Input and Output Fully Matched to 50  $\Omega$
- Integrated RF power detector
- Surface Mount QFN 5x5mm Package

### Applications:

- Communication systems
- Microwave instrumentations
- Point to Point Radios

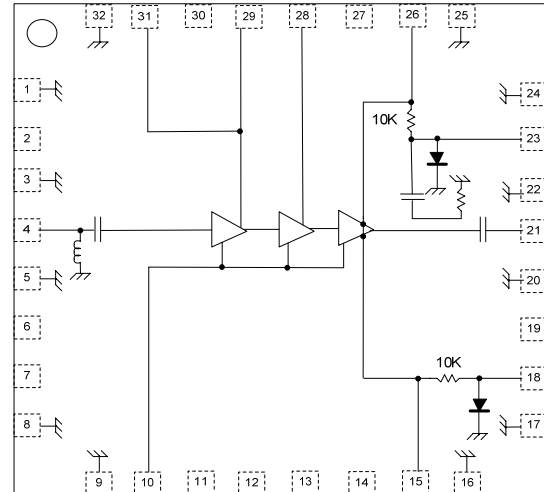

Functional Block Diagram

### Description:

The MMA-121633 is a GaAs MMIC linear power amplifier with 2-Watt output power and high gain over full 12.5 to 15.5GHz frequency range. This amplifier was optimally designed for high linearity applications at 5dB back-off from P-1 condition.

### Absolute Maximum Ratings: ( $T_a = 25\text{ }^\circ\text{C}$ )\*

SYMBOL	PARAMETERS	UNITS	Min.	Max.
Vds	Drain-Source Voltage	V		6.5
Vg	Gate-Source Voltage	V	-2.1	0
Ig	First Gate Current	mA	-17	17
Pd	Power Dissipation	W		16.8
Pin max	RF Input Power	dBm		20
Toper	Operating Temperature	$^\circ\text{C}$		-40 to +85
Tch	Channel Temperature	$^\circ\text{C}$		+150
Tstg	Storage Temperature	$^\circ\text{C}$		-55 to +150
Tmax	Max. Assembly Temp (20 sec max)	$^\circ\text{C}$		+250

\*Operation of this device above any one of these parameters may cause permanent damage.



# MMA-121633-R5

## 12.5-15.5GHz, 2W Power Amplifier

### Data Sheet

#### Electrical Specifications: $V_{ds}=6V, V_g=-0.9V, I_{ds}=1400mA, T_a=25\text{ }^\circ\text{C } Z_0=50\text{ ohm}$

Parameter	Units	Typical Data
Frequency Range	GHz	12.5 - 15.5
Gain (Typ / Min)	dB	23.5 / 22
Gain Flatness (Typ / Max)	+/-dB	1.5 / 2
Input RL(Typ/Max)	dB	10/8
Output RL(Typ/Max)	dB	10/8
Output P1dB(Typ/Min)	dBm	32/31
IM3 Level @Po=20dBm/tone	dBc	-44
Output Psat(Typ/Min)	dBm	34/33
Operating Current at P1dB (Typ/Max)	mA	2000 / 2300
Thermal Resistance	$^\circ\text{C} / \text{W}$	3.8

(1) Output IM3 is measured with two tones at output power of 20 dBm/tone separated by 20 MHz.

### Typical RF Performance: $V_{ds}=6V$ , $V_g=-0.9V$ , $I_{ds}=1400mA$ , $Z_0=50\ \text{ohm}$ , $T_a=25\ ^\circ\text{C}$

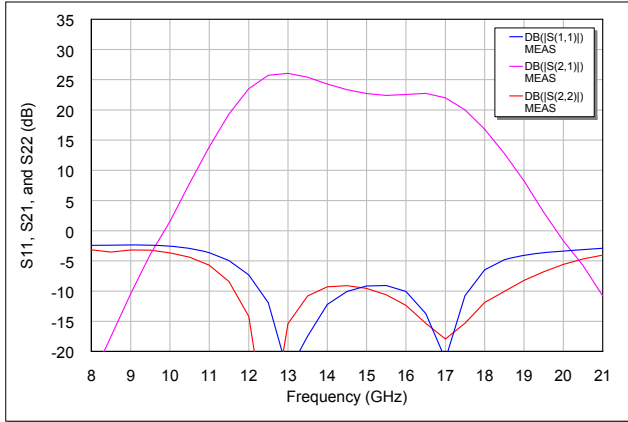

S11[dB], S21[dB], and S22[dB] vs. Frequency

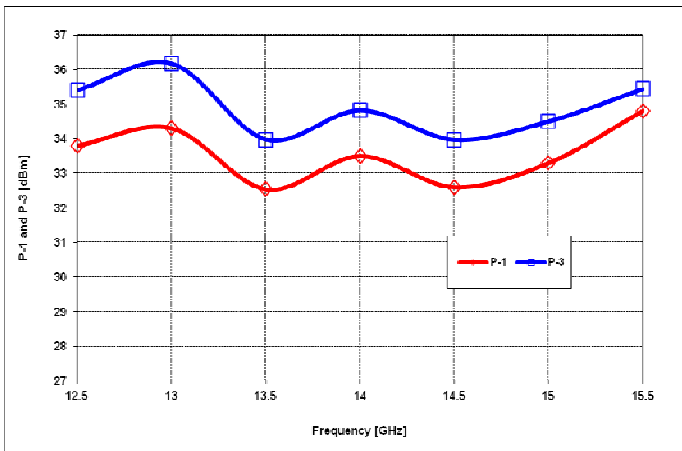

P-1 and P<sub>sat</sub> vs. Frequency

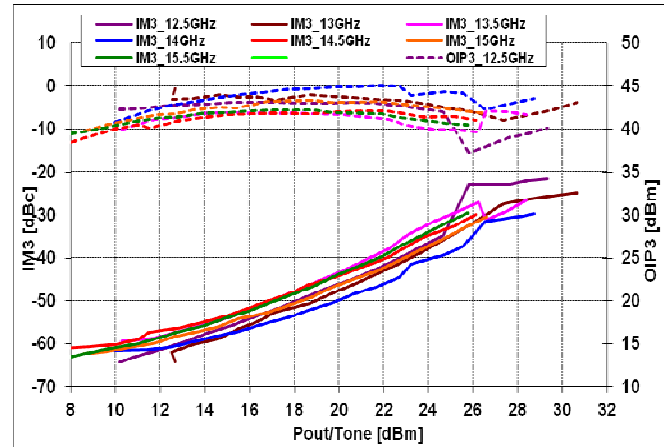

IM3 Level [dBc] vs. output power/tone [dBm]

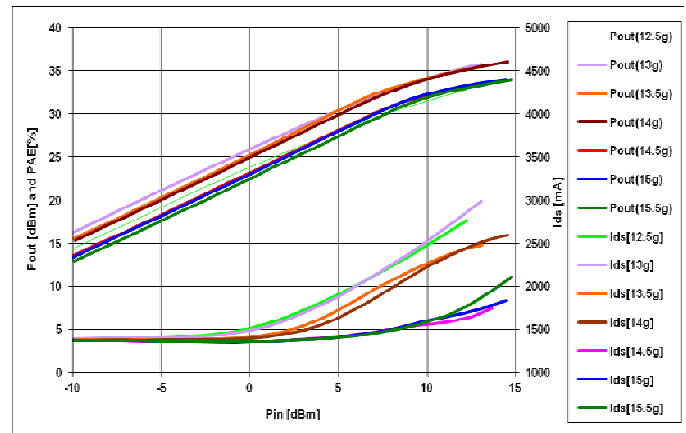

P<sub>out</sub>[dBm], and I<sub>ds</sub>[mA] vs. Input power [dBm]

### Typical Bias dependent RF Performance: Vds=4V

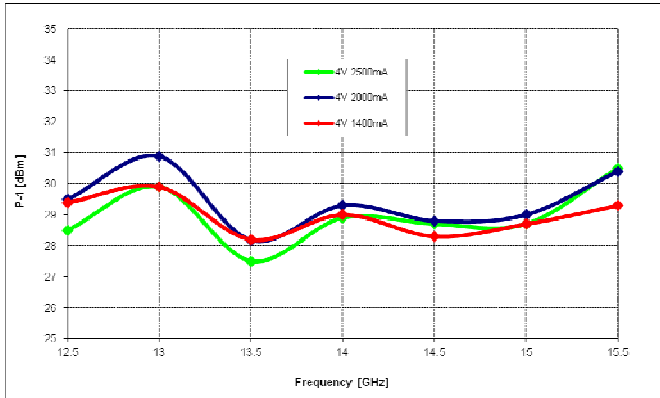

Bias dependent P-1 vs. Frequency

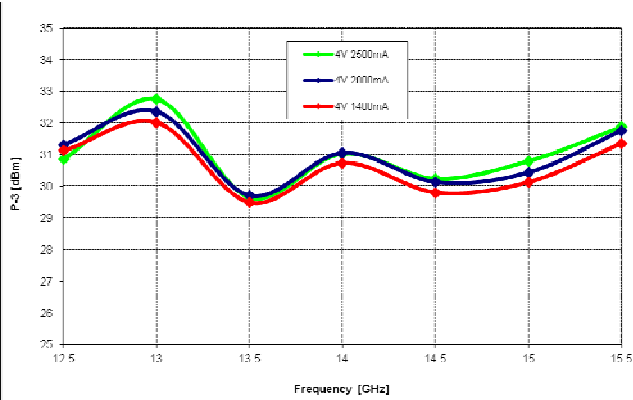

Bias dependent P-3 vs. Frequency

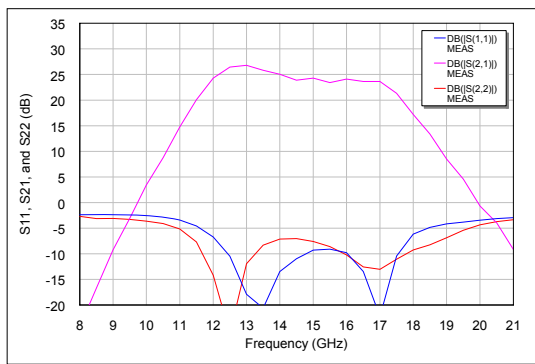

Vds=4V, Idsq=1400mA

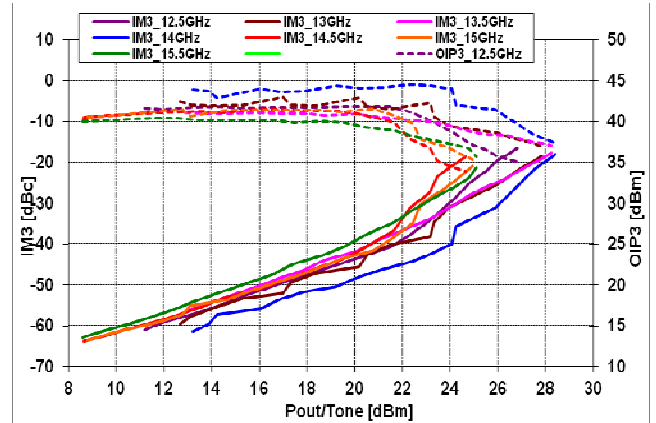

@Vds=4V, Idsq=1400mA

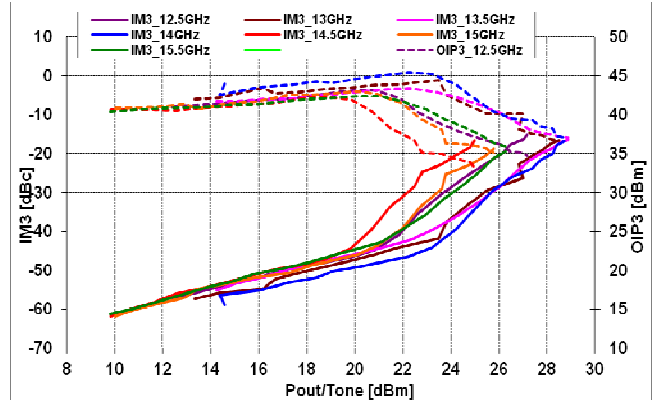

@Vds=4V, Idsq=2000mA

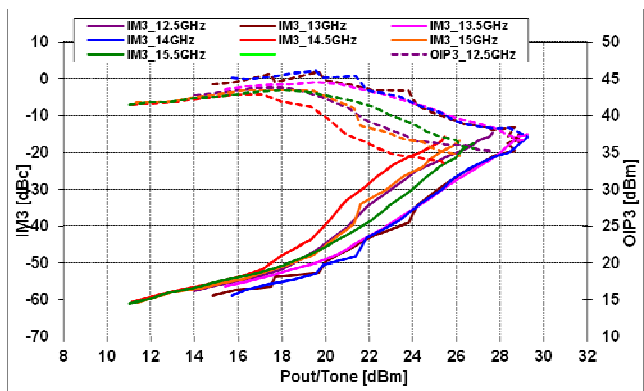

@Vds=4V, Idsq=2500mA

### Typical Bias dependent RF Performance: $V_{ds}=5V$

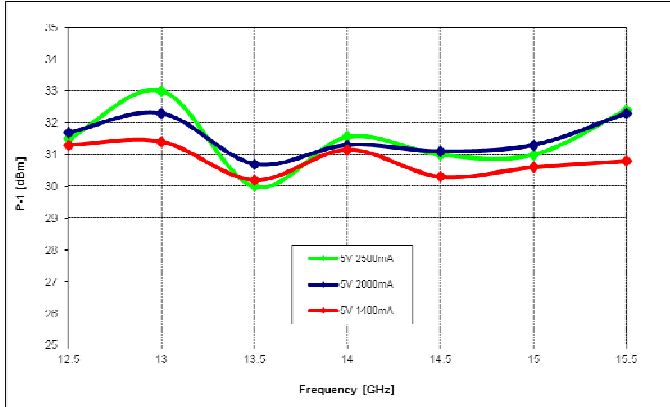

Bias dependent P1 vs. Frequency

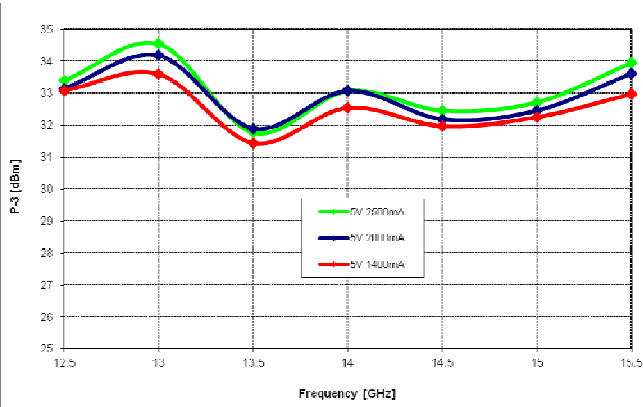

Bias dependent P-3 vs. Frequency

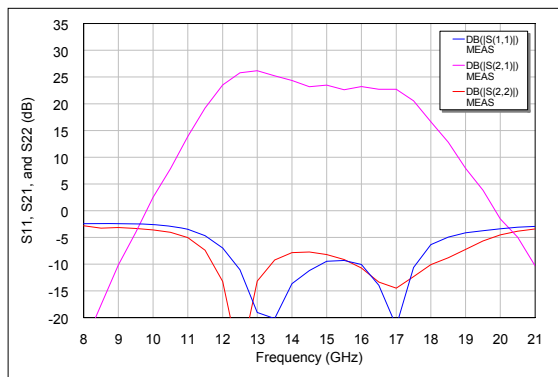

$V_{ds}=5V, I_{ds}=1400mA$

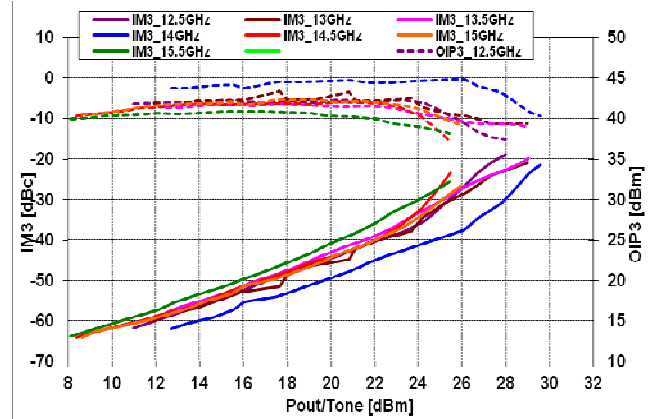

@ $V_{ds}=5V, I_{dsq}=1400mA$

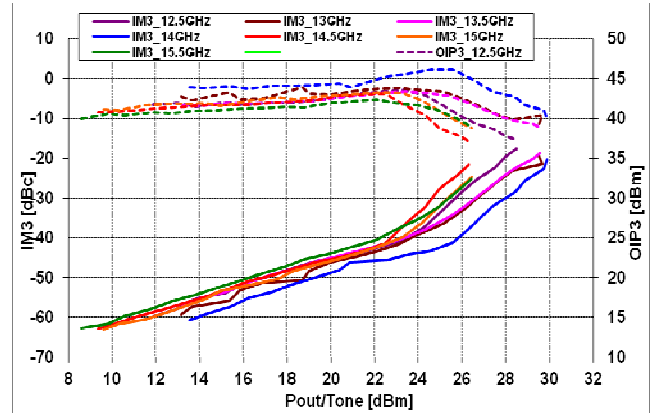

@ $V_{ds}=5V, I_{dsq}=2000mA$

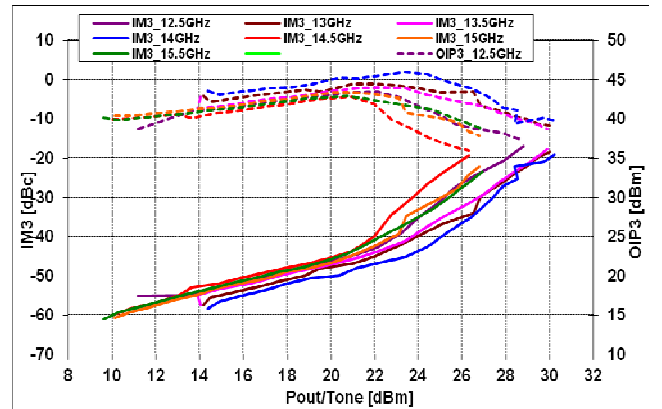

@ $V_{ds}=5V, I_{dsq}=2500mA$

### Typical Bias dependent RF Performance: $V_{ds}=6V$

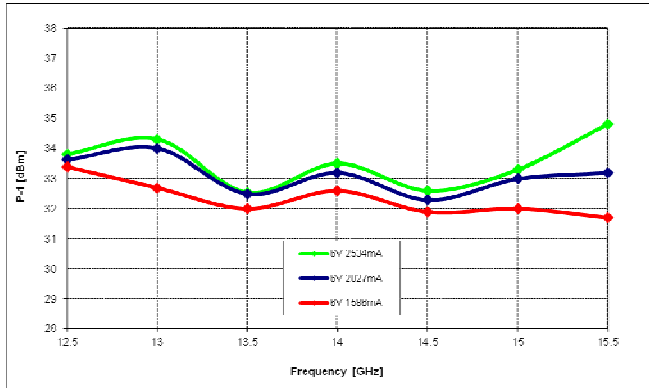

Bias dependent P1 vs. Frequency

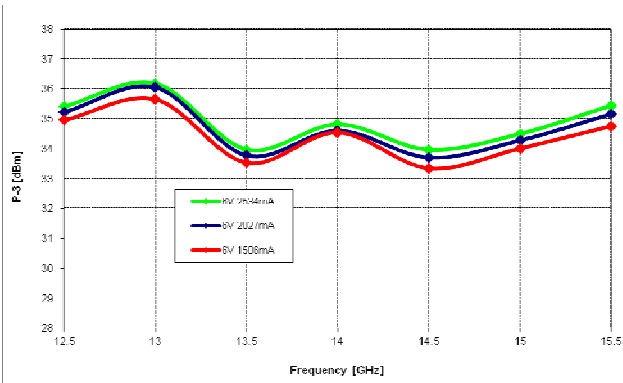

Bias dependent P-3 vs. Frequency

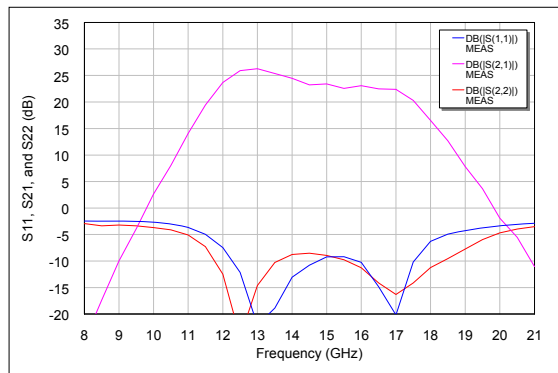

$V_{ds}=6V$ ,  $I_{ds}=2000mA$

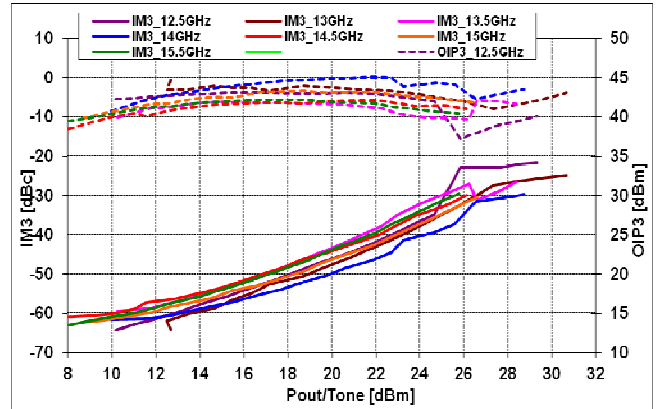

@ $V_{ds}=6V$ ,  $I_{ds}=1400mA$

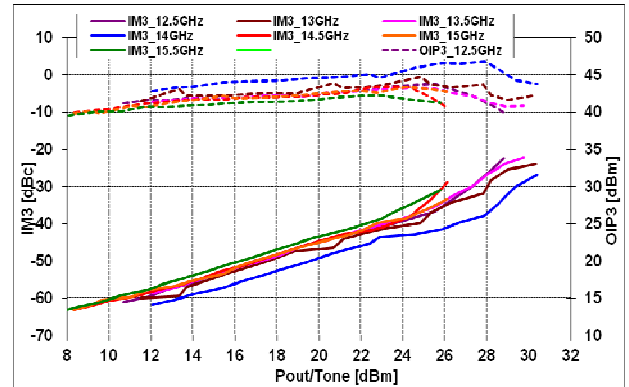

@ $V_{ds}=6V$ ,  $I_{ds}=2000mA$

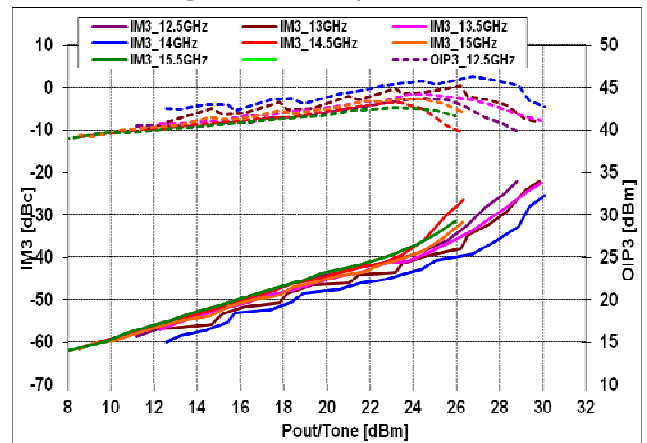

@ $V_{ds}=6V$ ,  $I_{ds}=2500mA$

### Typical Over Temperature Performance: $V_{ds}=6V, I_{ds}=1400mA, Z_0=50\text{ ohm}, T_a=-40, 25, \text{ and } 85\text{ }^\circ\text{C}$

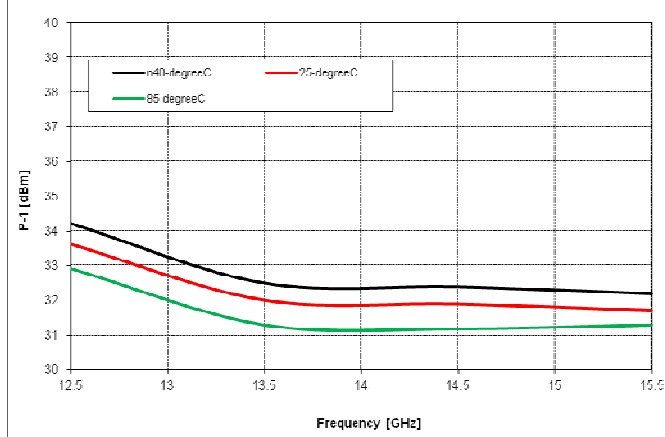

P1 over temperature

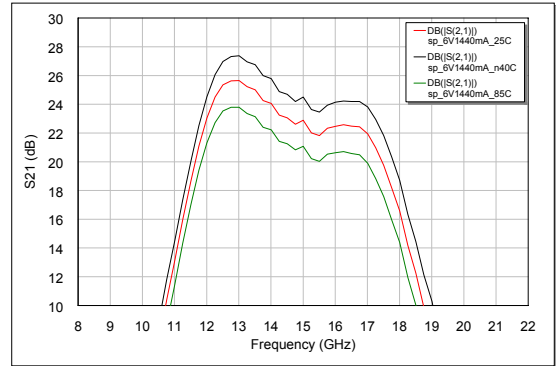

S21(dB) over temperature

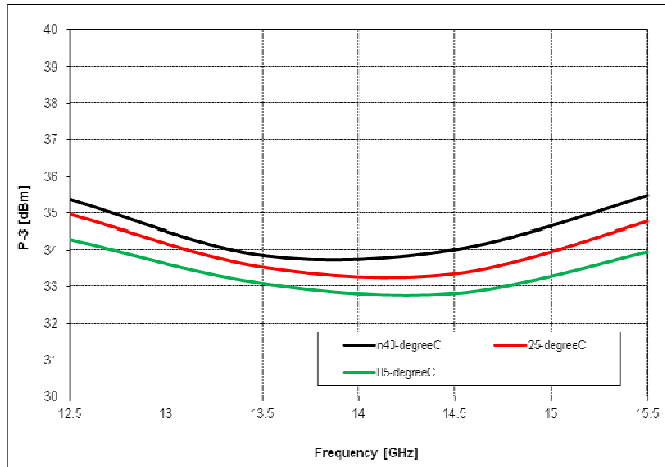

P-3 over temperature

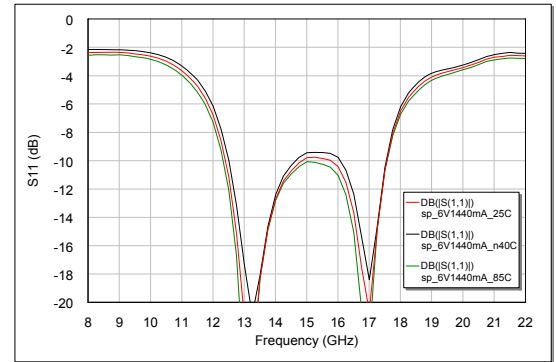

S11(dB) over temperature

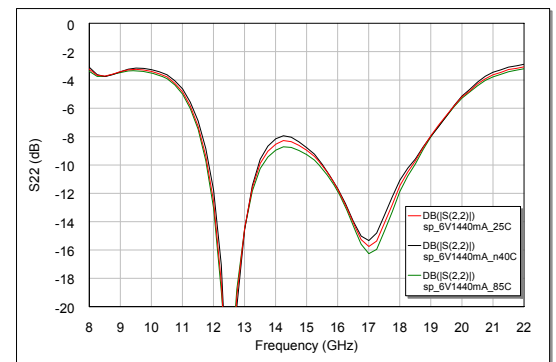

S22(dB) over Voltage

**Typical Power Detector Voltages:  $V_{ds}=6V$ ,  $I_{dsq}=1.4A$ , Frequency=13GHz**

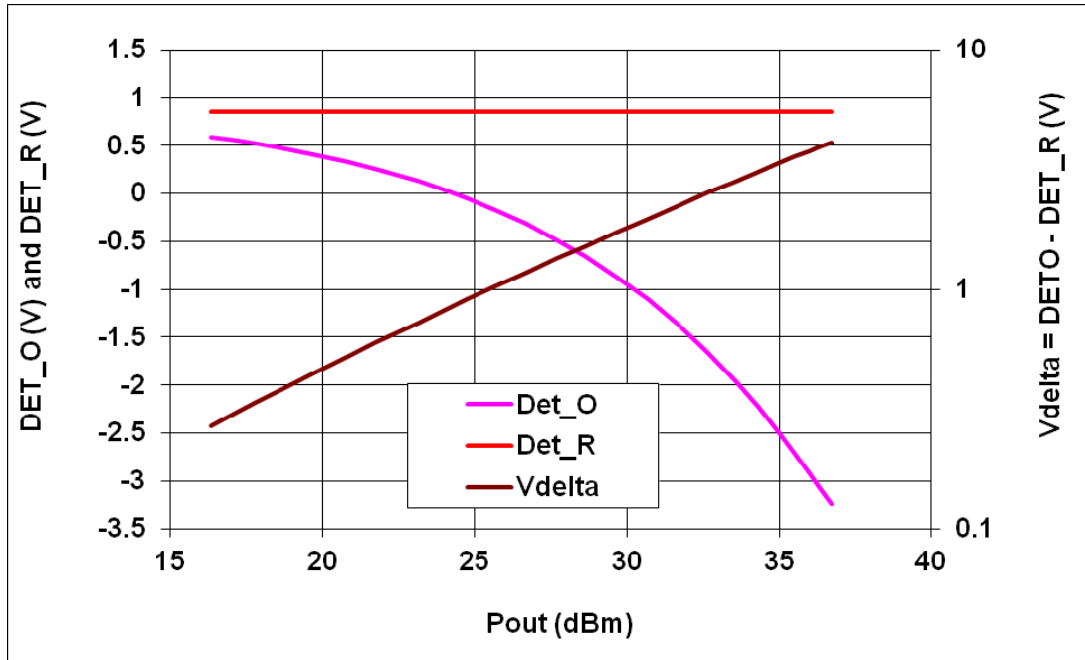

**Detector Voltages (DET\_O and DET\_R) vs. Output RF power**

**Vdelta axis is Log-scale.**

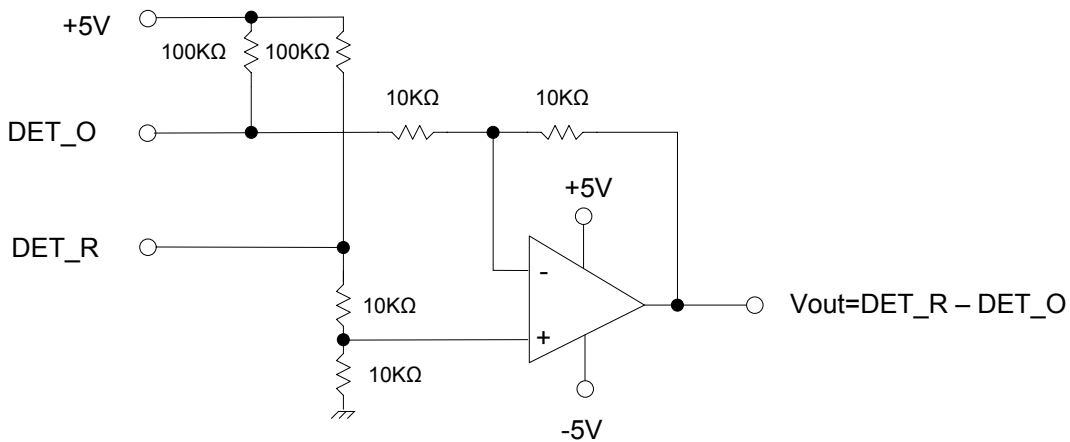





---

## Applications

The **MMA-121633-R5** MMIC power amplifier is designed for use as a power stage amplifier in microwave transmitters. It is ideally suited for 12.7 to 15.4GHz band point to point radio applications requiring a flat gain response and excellent linearity performance. This amplifier is provided as a 5x5mm QFN package, and the packaged amplifier is fully compatible with industry standard high volume surface mount PCB assembly processes.

## Biassing and Operation

The recommended bias conditions for best performance for the **MMA-121633-R5** are  $V_{DD} = 6.0V$ ,  $I_{dsq} = 1400mA$ . Performance improvements are possible depending on applications. The drain bias voltage range is 4 to 6V and the quiescent drain current biasing range is 1200mA to 2500mA. A single DC gate supply connected to  $V_g$  will bias all the amplifier stages. Muting can be accomplished by setting  $V_g$  to the pinch-off voltage ( $V_p = -2V$ ). The gate voltage ( $V_g$ ) should be applied prior to the drain voltages ( $V_{d1}$ ,  $V_{d2}$ , and  $V_{d3}$ ) during power up and removed after the drain voltages during power down. The RF input port is connected internally to the ground for ESD protection purpose; therefore, an input decoupling capacitor is needed if the preceding output stage has DC present. The RF output is DC decoupled internally. Typical DC supply connection with bi-passing capacitors for the **MMA-121633-R5** is shown in following pages.

**MMA-121633-R5** contains optional temperature compensated output power detectors. Typical detection voltage vs. output power is shown in previous page. To obtain over temperature compensation, a recommended differential amplifier is required.

## Assembly Techniques

GaAs MMICs are ESD sensitive. ESD preventive measures must be employed in all aspects of storage, handling, and assembly. MMIC ESD precautions, handling considerations, die attach and bonding methods are critical factors in successful GaAs MMIC performance and reliability.

## Package Pin-out:

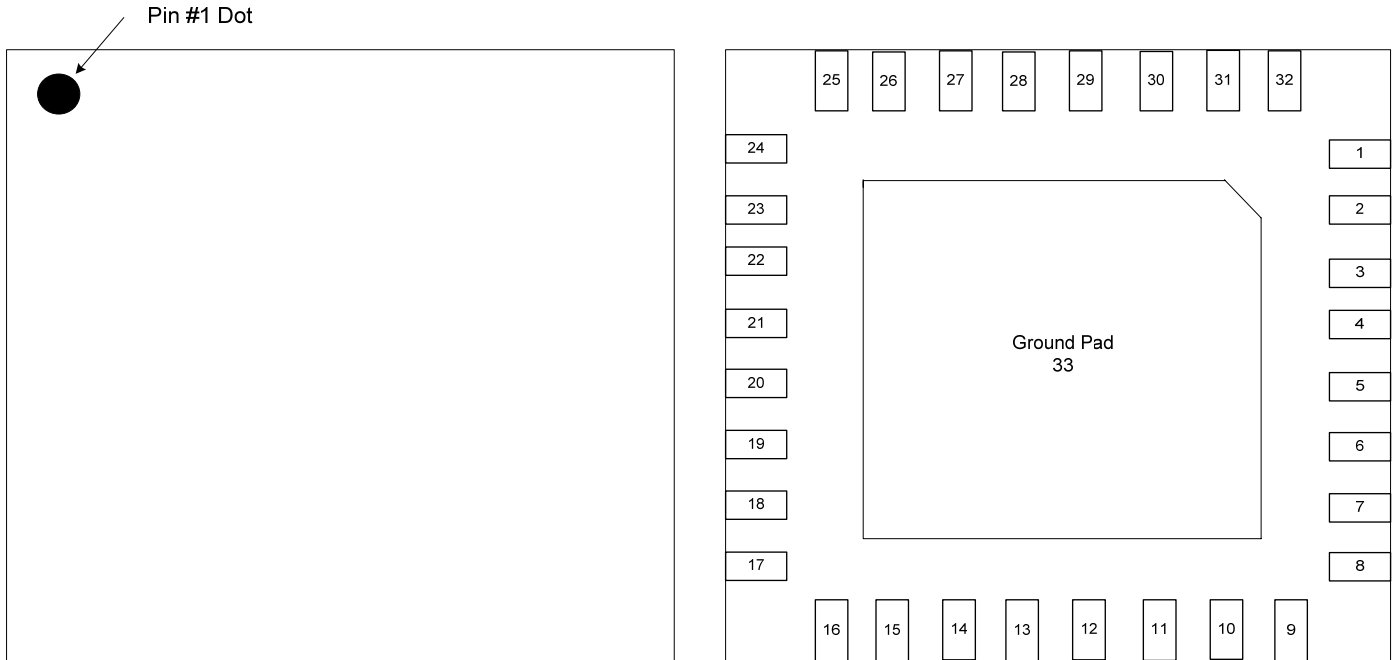

Pin	Description
4	RF Input
21	RF Output
10	Vg
31	Vd1
28	Vd2
15, 26	Vd3
18	DET_Reference
23	DET_Output
1, 3, 5, 8, 9, 16, 17, 20, 22, 24, 25, 32, 33	Ground
2, 6, 7, 11, 12, 13, 14, 19, 27, 29, 30	N/C

## Mechanical Information:

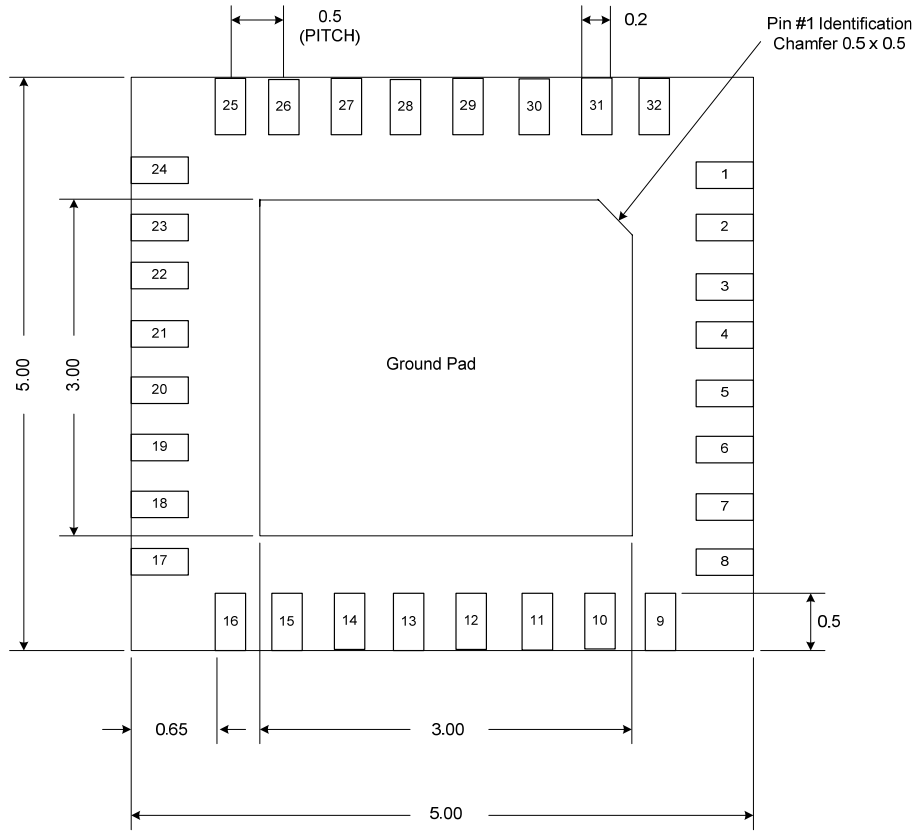

BOTTOM VIEW

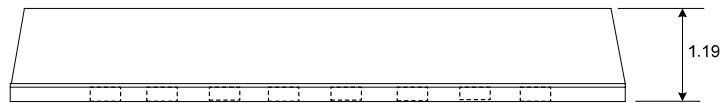

SIDE VIEW

The units are in [mm].

## Application Circuit:

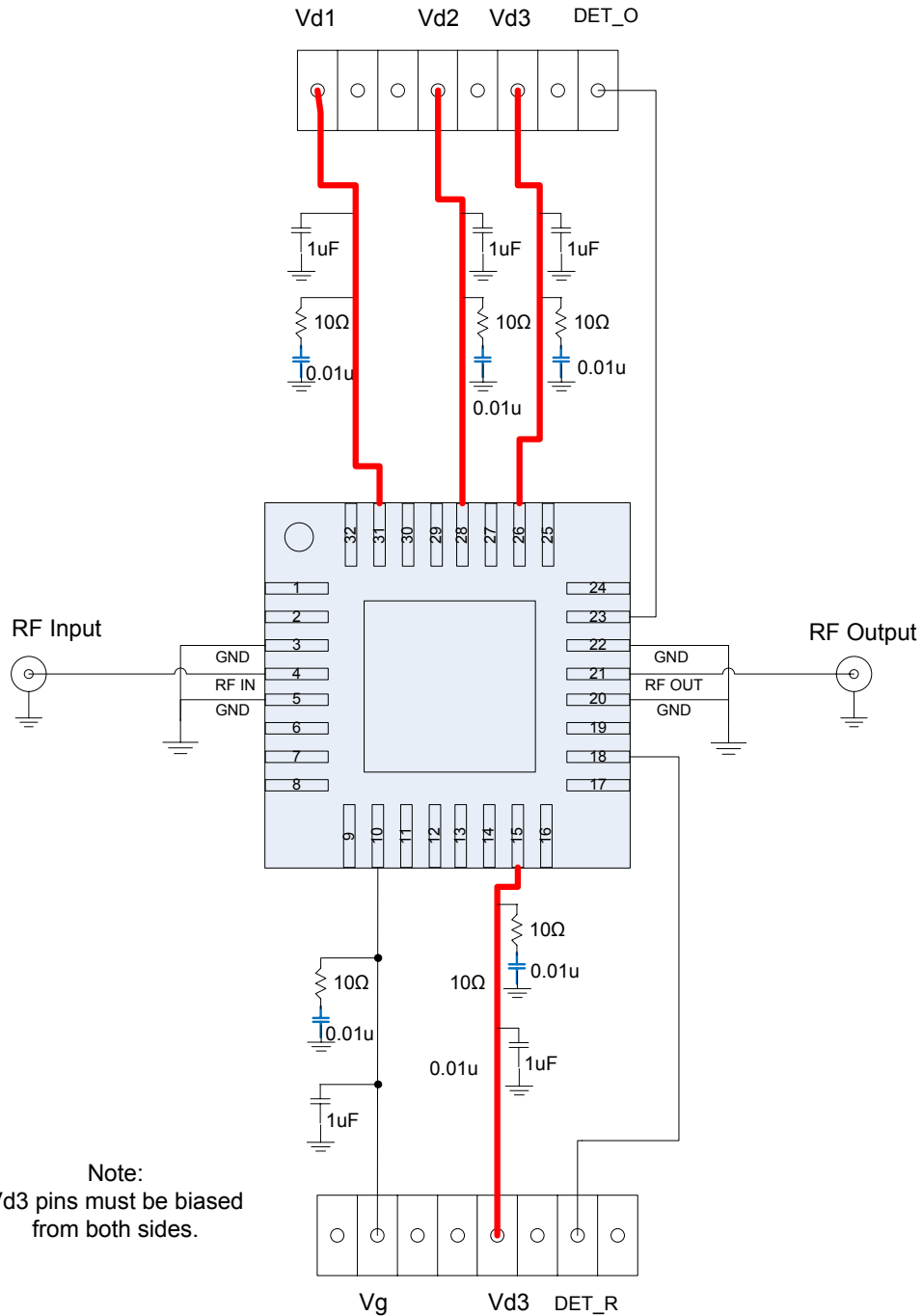

## Recommended Application Board Design:

Board Material is 10mil (Dielectric) thickness Rogers 4350B with 0.5oz copper clads.

Board is soldered on a gold plated solid copper block and adequate heat-sinking is required for 16.8W total power dissipation.

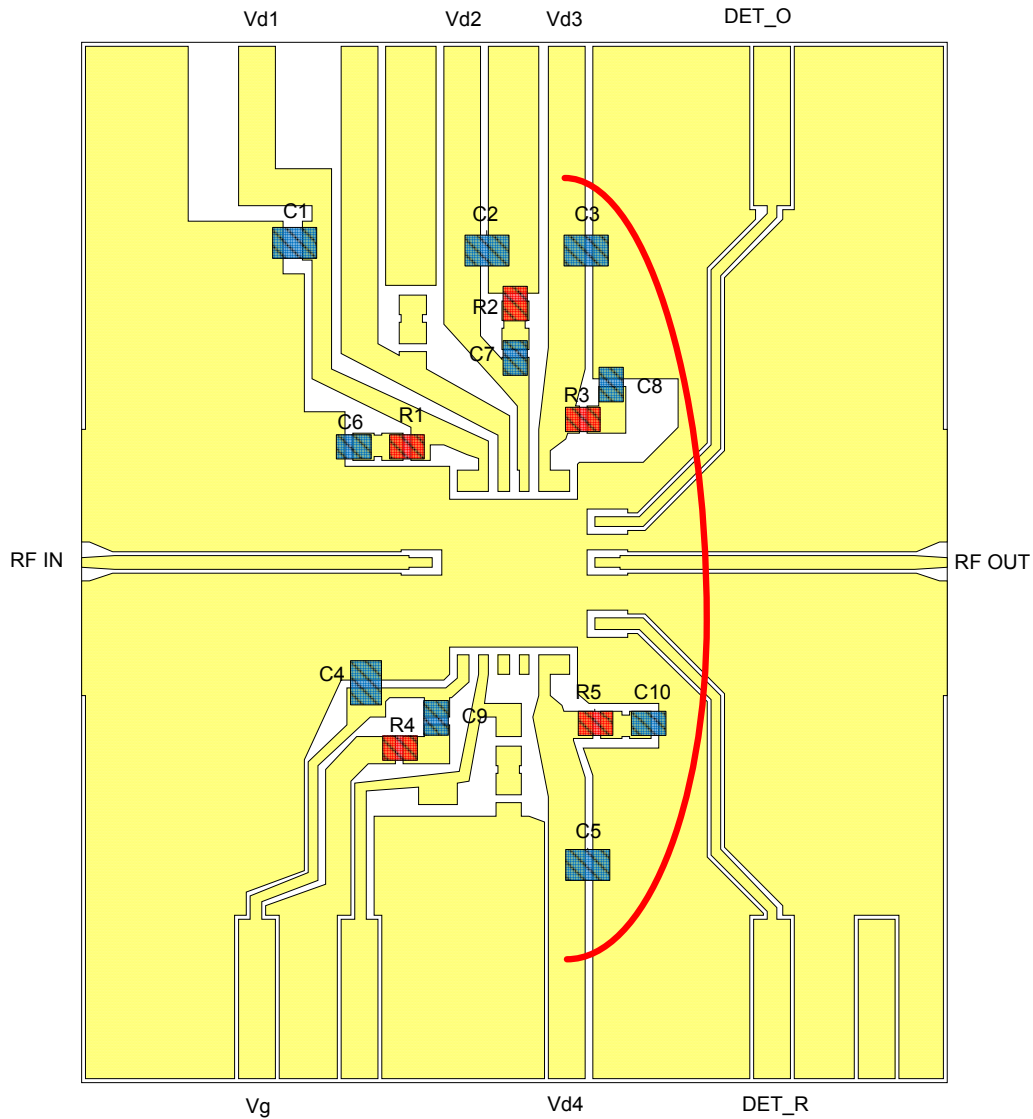

Part	Description
C1, C2, C3, C4, C5	1uF capacitor (0603)
C6, C7, C8, C9, C10	0.01uF Capacitor (0402)
R1, R2, R3, R4, R5	10Ω Resistor (0402)

## Recommended Application Board Design:

Board Material is 10mil (Dielectric) thickness Rogers 4350B with 0.5oz copper clads. The board material and mounting pattern, as defined in the data sheet, optimizes RF performance and is strongly recommended. An electronic drawing of the land pattern is available upon request from MwT Sales & Application Engineering.

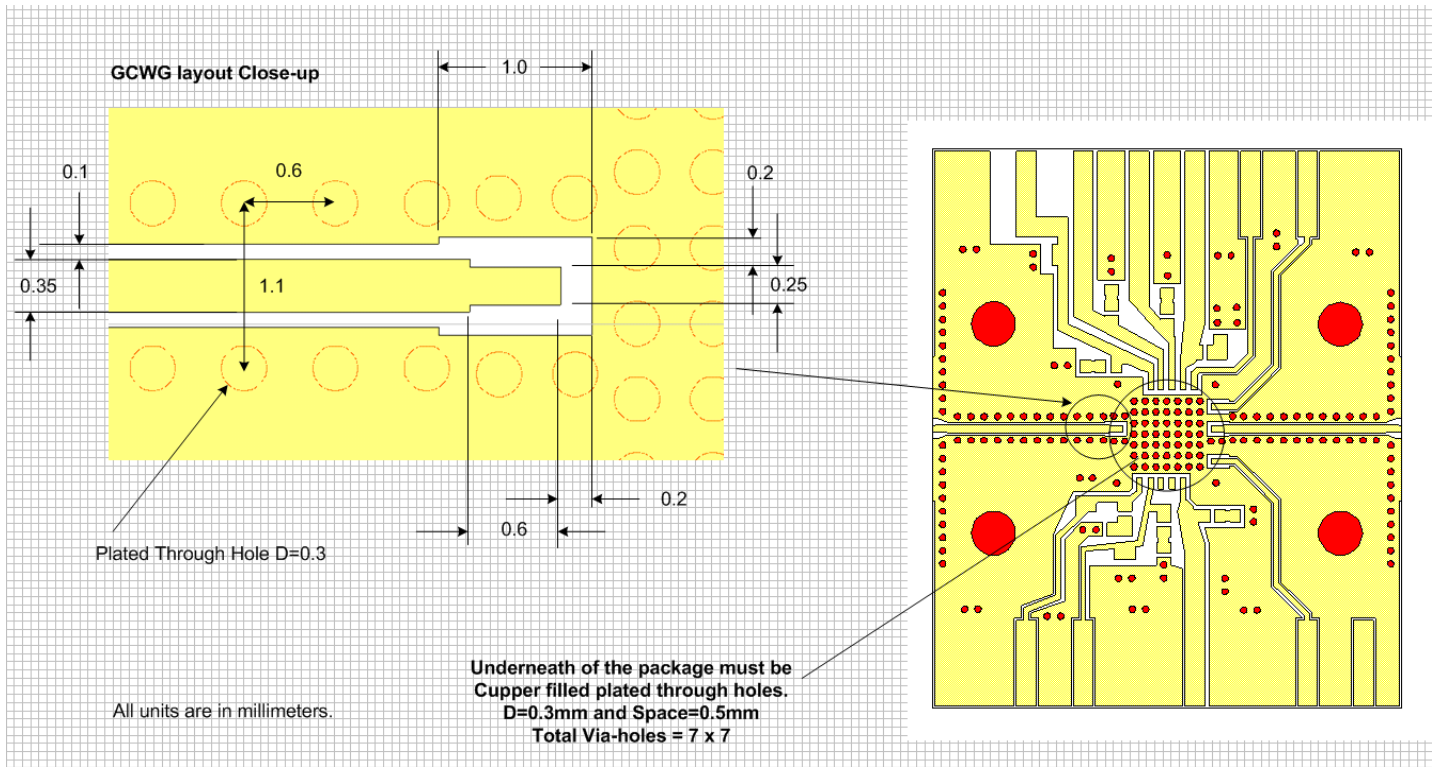

Copper filled thru vias  
D=0.3mm, Space=0.5mm  
7x7

For best thermal  
dissipation, 3mm square  
Copper filled PCB is  
recommended.

