

NEW

0.7mm height FPC-to-Board Connectors up to 10Amps

BM25 Series

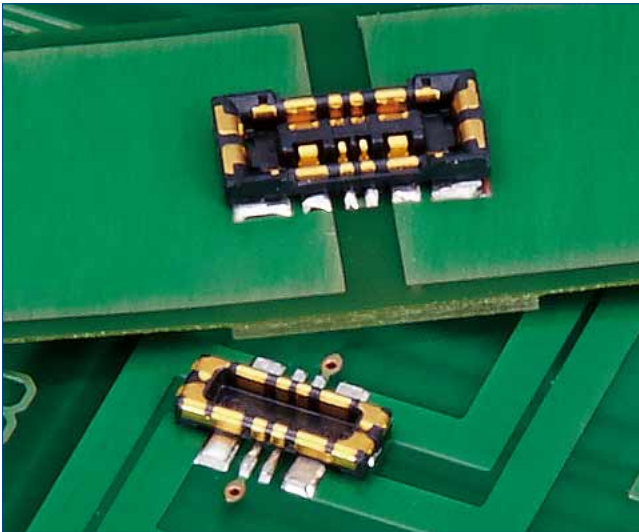

■ Features

1. Capable of high current power supply [Rated current : 10A]

10Amps for power contact, 0.3Amps for signal contact.

Allows for power source design with a high safety rating.

2. Robust [70N*1]

Longitudinal metal coated guide mitigates damage in a misaligned mating.

3. Contributes to power saving [1mΩ or less*2]

Contact Resistance Specifications

Power contact : 5mΩ or less

Signal contact : 30mΩ or less

The above contact resistance specifications contribute to power saving.

Contact Resistance Measurement : Power contact : 1mΩ or less, Signal contact : 10mΩ or less

*1 : Actual measurement of the failure strength in a misaligned mating operation.

*2 : Actual contact resistance measurement of the power contact, does not guarantee that the value is 1mΩ or less.

■ Usage

Devices that are required to be thinner and smaller, such as mobile phones, wearable terminals and tablet PCs.

Capable of high current power supply

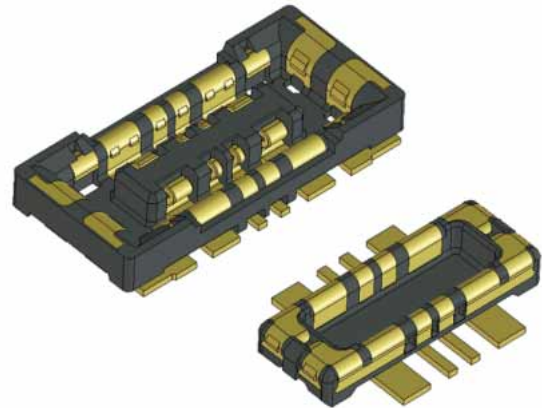

Power contact : 10A/pin
Signal contact : 0.3A/pin

Fig.1

Space-saving

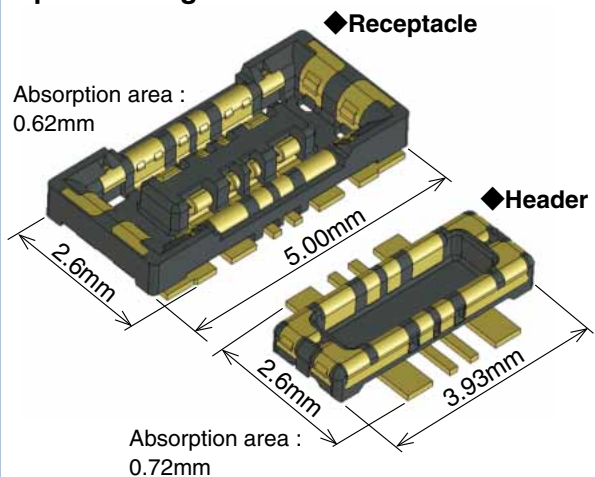

Fig.2

Robust Design

Unique metal guide considerably mitigates the housing damage due to incorrect mating

Failure strength : 70N

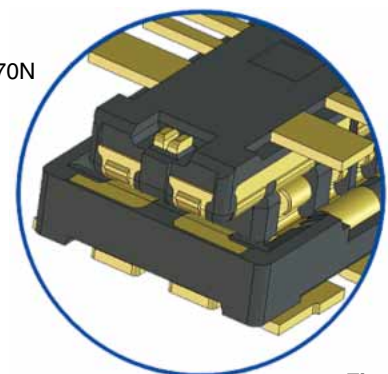

Fig.3

Product Specifications

Ratings	Current rating	Power contact : 10A Signal contact : 0.3A	Operating temperature range	-40 to 85°C (Note 1)
	Voltage rating	30V AC/DC	Storage temperature range	-10 to 60°C (Note 2)

Item	Specification	Conditions
1. Contact resistance	Signal contact : Max of 30mΩ Power contact : Max of 5mΩ	Measured at 20mV AC, 1kHz, 1mA
2. Insulation resistance	Minimum of 1000MΩ	Measured at 100V DC
3. Withstanding voltage	No flashover or insulation breakdown	Conduct 150V AC for 1 minute
4. Durability	Contact resistance : Signal contact Max of 30mΩ Power contact Max of 5mΩ	10 mating cycles
5. Vibration	No electrical discontinuity of 1μs or longer	Frequency : 10 to 55Hz, single amplitude of 0.75mm, 10 cycles in each of 3 axis directions for 5 minutes / cycle
6. Humidity	Contact resistance : Signal contact Max of 30mΩ Power contact Max of 5mΩ Insulation resistance : Min of 100MΩ	96 hours at a temperature of 40 ±2°C and a humidity range from 90 to 95%
7. Temperature cycle	Contact resistance : Signal contact Max of 30mΩ Power contact Max of 5mΩ Insulation resistance : Min of 100MΩ	-55±3°C : 30 minutes → 85±2°C : 30 minutes, 5 cycles
8. Solder Heat Resistance	No signs of melting or deformity on the molded resin parts and no negative effects on performance.	Reflow : according to the Recommended Solder Profile Hand soldering : Soldering iron temperature 350°C, no more than 3 seconds of contact

Note 1 : Includes temperature rise caused by current flow.

Note 2 : The term "storage" here refers to products stored for a long period prior to board mounting and use. The operating temperature and humidity range covers the non-energized condition of connectors after board mounting and the temporary storage conditions during transportation, etc.

Materials / Finish

Product	Part	Material	Finish	UL standard
Receptacle / Header	Insulator	LCP	Black	UL94V-0
	Contacts	Copper alloy	Gold plated	—

Product Number Structure

Refer to the chart below when determining the product specifications from the product number.

Please select from the product numbers listed in this catalog when placing orders.

● Receptacles / Headers

BM 25 - * S / 2 - V (51)

① ② ③ ④ ⑤ ⑥ ⑦

① Series name : BM	⑤ Number of power contacts
② Series No. : 25	⑥ Termination type V : Straight SMT
③ Number of signal contacts	
④ Connector type : S : Receptacle P : Header	⑦ Gold plated specification and packaging status (51) : Gold plate thickness 0.05μm Embossed tape packaging (20,000pcs/reel)

Receptacle

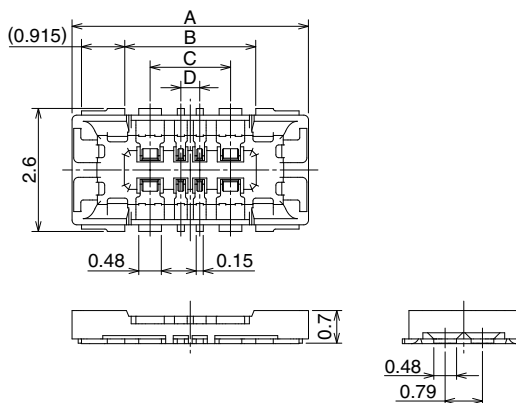
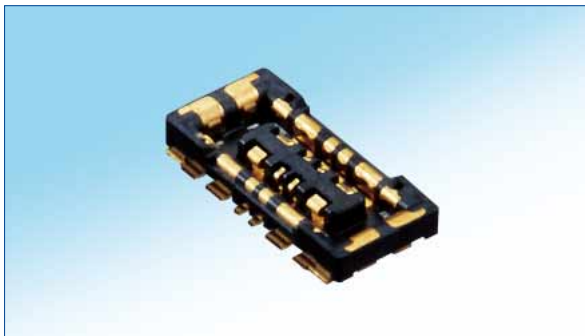

Recommended PCB layout

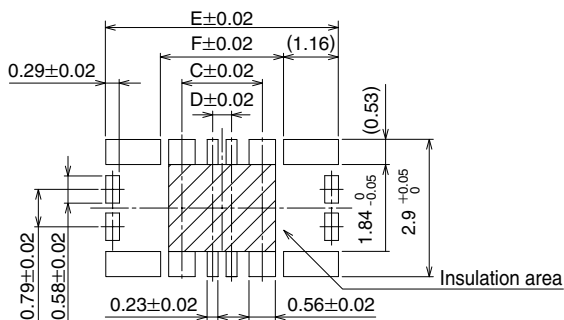

Recommended metal mask dimensions (mask thickness : 100µm)

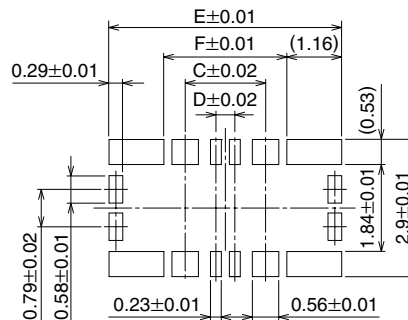

Unit : mm

Part No.	HRS No.	No. of contacts		A	B	C	D	E	F
		Signal	Power						
BM25-4S/2-V(51)	677-1200-0 51	4	2	5	2.77	1.7	0.4	4.92	2.6

Header

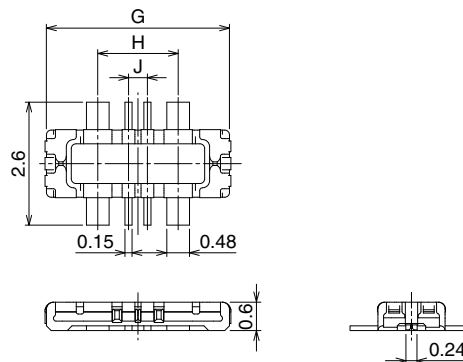
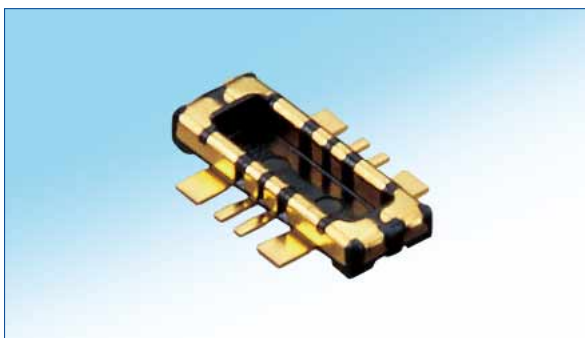

Recommended PCB layout

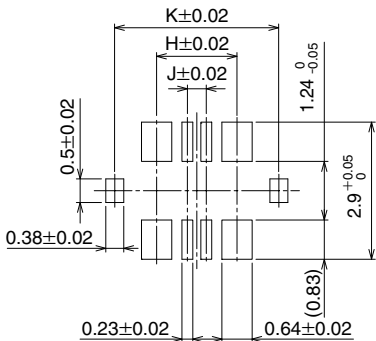

Recommended metal mask dimensions (mask thickness : 100µm)

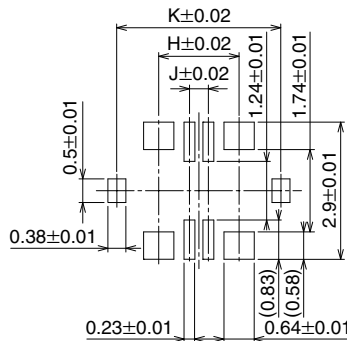

Unit : mm

Part No.	HRS No.	No. of contacts		G	H	J	K
		Signal	Power				
BM25-4P/2-V(51)	677-1201-2 51	4	2	3.93	1.7	0.4	3.47

◆ Embossed Tape Dimensions (conforms to JIS C 0806)

● Receptacle

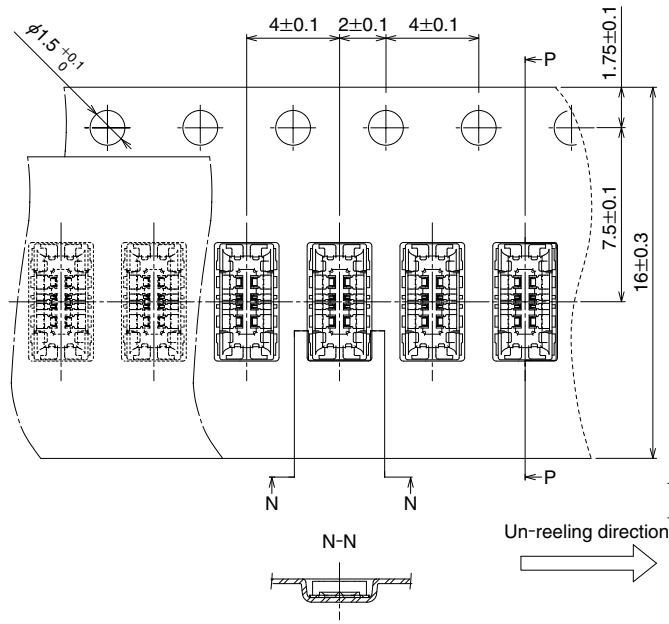

● Reel dimensions

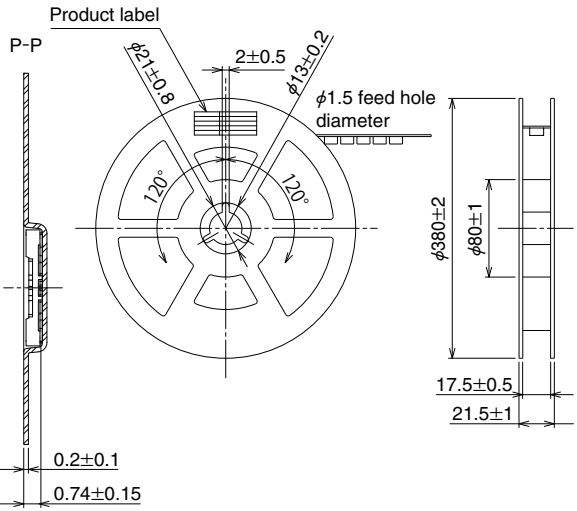

● Header

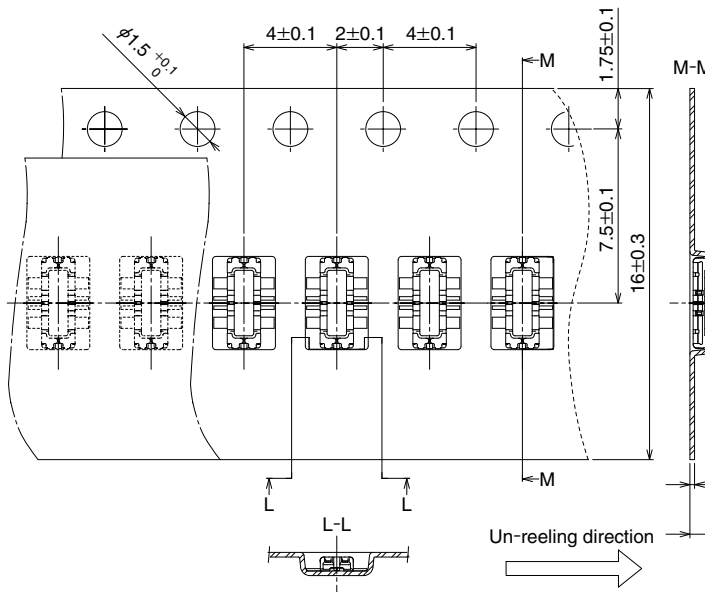

● Reel dimensions

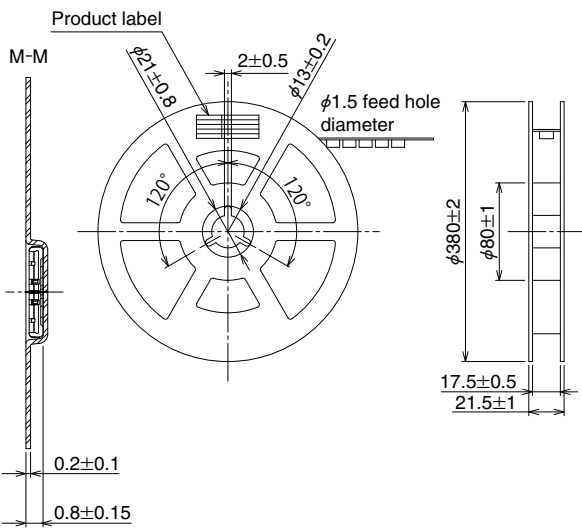

◆Precautions

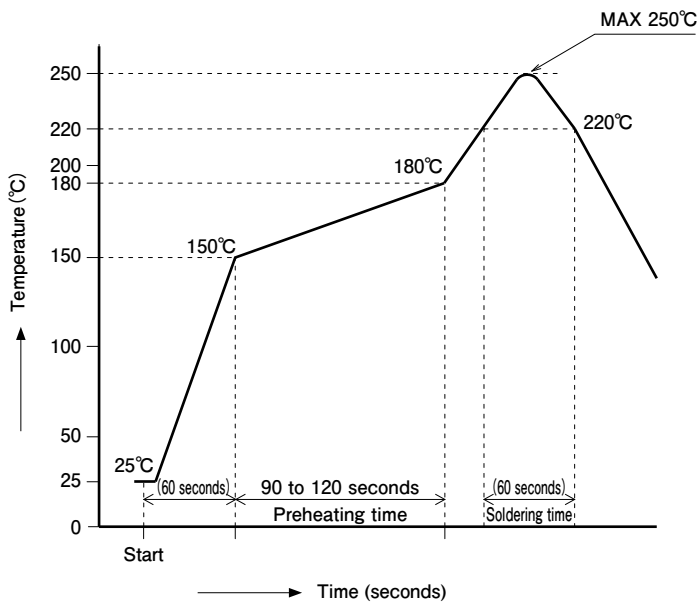
<p>1. Recommended temperature profile</p>	 <p>[Conditions]</p> <ol style="list-style-type: none"> 1. Peak temperature : 250°C 2. Heating unit : No less than 220°C for no more than 60 seconds 3. Preheating unit : 150 to 180°C for 90 to 120 seconds 4. Number of times : No more than 2 times <p>Note 1 : The temperature is the surface temperature of the PCB in the vicinity of the connector lead part.</p> <p>Note 2 : When you use nitrogen reflow, please mount the product with the oxygen concentration at a minimum of 1,000 [ppm]. Please contact us if the concentration is below 1,000 [ppm].</p>
<p>2. Recommended hand soldering conditions</p>	<p>Soldering iron temperature : 340 ± 10°C, Soldering time : within 3 seconds</p>
<p>3. Recommended screen thickness/aperture ratio (pattern area ratio)</p>	<p>Thickness : 0.1mm Open area ratio : 100% for signal contact, and 100% for power contact on the Receptacle side. 100% for signal contact, and 70% for power contact on the Header side.</p>
<p>4. Warpage of the PCB</p>	<p>A maximum of 0.02mm at the center part of the connector based on both ends of the connector.</p>
<p>5. Cleaning</p>	<p>Not recommended. If you clean this product, please evaluate the performance before using it. (Cleaning may cause a change in the mating/unmating property and its resistance to environment)</p>
<p>6. Notes</p>	<ul style="list-style-type: none"> ■ Care should be taken that mating/unmating operation when the product is not mounted on the PCB could cause damage or deformation, etc. of the contact. ■ Avoid supporting the PCB only by connectors, and support it by other means than connectors. ■ Care should be taken that excessive prying mating/unmating could cause damage. ■ During hand soldering, do not apply flux which will cause flux oozing on connector. ■ This product may differ in hue due to production lot variability, but it doesn't have any influence on the performance. ■ Please refer to the next page for the precautions for mating/unmating. ■ Considering the possibility of disengagement due to the counterforce caused by the drop, impact and routing of FPC, fix the mated state by the use of housings and cushion materials, etc. ■ Caution! Do not use the connector in non-recommended conditions (i.e., rated current, rated voltage, PCB design and operating environment, etc.). Such usage could lead to material outgassing, ignition, or short-circuit, etc. <p>Refer to the specifications and the guidelines for board pattern dimensions, board cautions, and connector treatment.</p> <p>Please contact Hirose if using the connector under conditions other than those described in the specifications and the guidelines is being considered.</p>

Aug. 1. 2022 Copyright 2022 HIROSE ELECTRIC CO., LTD. All Rights Reserved.

● Handling warning when mating the connector

Please use cushioning material to prevent incorrect mating.
The connector may disconnect due to the impact from drop etc.

Please use cushioning material of appropriate size covering the entire connector.

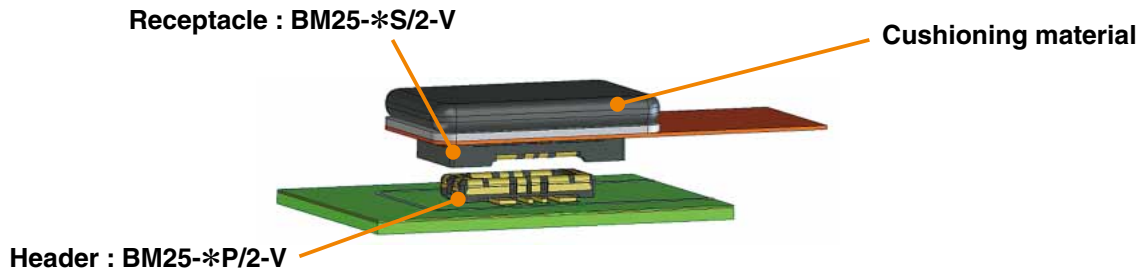

Mating procedure

1. Align the connector.

Product has a guide rib on the outer wall to support mating operation. Align the connector using this guide rib.

When aligning the connector, look for the guide port without applying excessive force.

2. Mate the connector after alignment.

3. Check the mated status.

If the connector is not correctly mated, remove it once and mate it again.

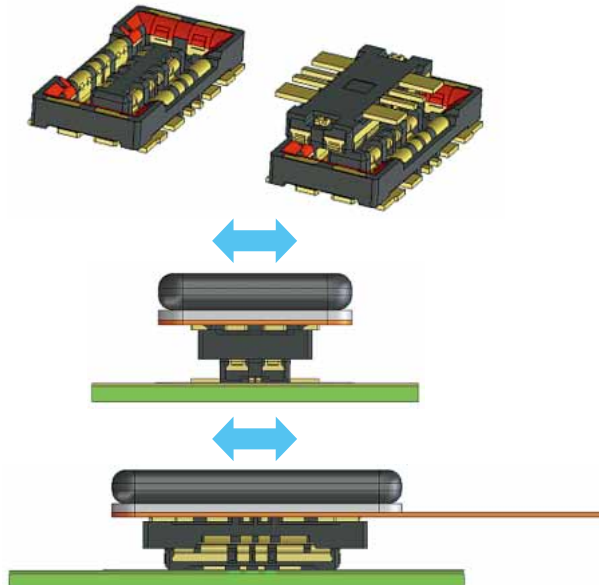

How to pull it out

If you apply a strong force in the horizontal direction when un-mating, the contact could be deformed and increase the contact resistance.

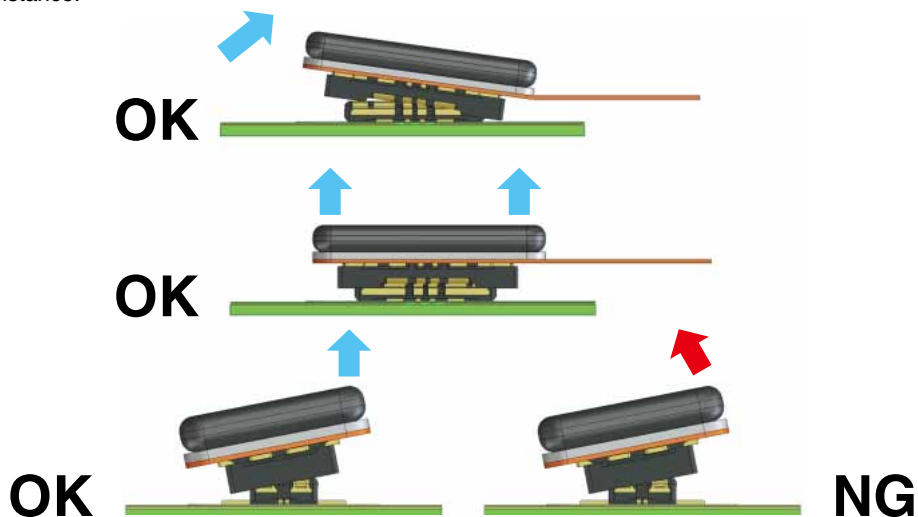

● Handling warning when un-mating the connector

Caution for FPCs that are not strong enough

In the case of a thin FPC board or a board without any reinforcing plate, please evaluate the mating.
 If the FPC board doesn't have enough rigidity, the solder joint could fail.
 Please check the mated status in advance with the FPC board you intend to use.
 Recommended thickness of the reinforcing plate : SUS 0.2mm, FR-40.3mm

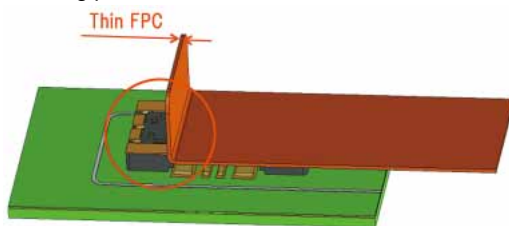

Caution for the dimensions within the receptacle pattern

Please meet the recommended pattern width.
 If not, solder wicking could occur.

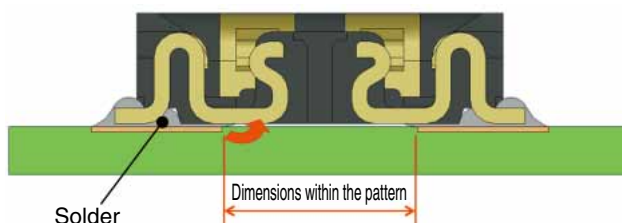

Please design without dividing the current path of the power PAD module into multiple branches.

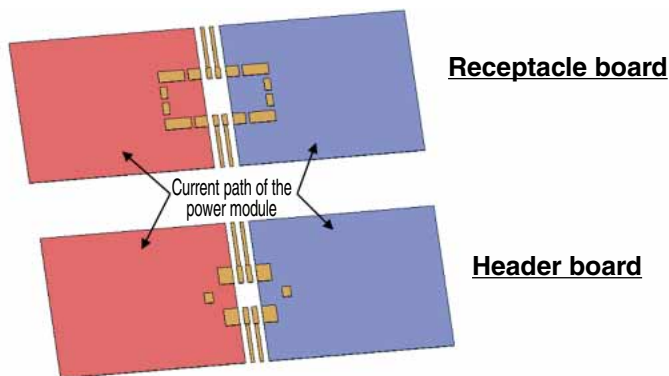

OK

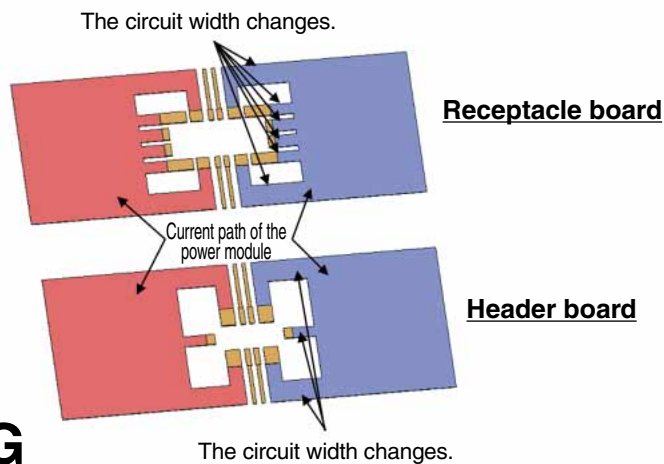

NG

USA:

HIROSE ELECTRIC (U.S.A.), INC. HEADQUARTERS CHICAGO OFFICE
2300 Warrenville Road, Suite 150,
Downers Grove, IL 60515
Phone : +1-630-282-6700
<http://www.hirose.com/us/>

USA:

HIROSE ELECTRIC (U.S.A.), INC. SAN JOSE OFFICE
2841 Junction Ave, Suite 200
San Jose, CA. 95134
Phone : +1-408-253-9640
Fax : +1-408-253-9641
<http://www.hirose.com/us/>

USA:

HIROSE ELECTRIC (U.S.A.), INC. DETROIT OFFICE (AUTOMOTIVE)
17197 N. Laurel Park Drive, Suite 253,
Livonia, MI 48152
Phone : +1-734-542-9963
Fax : +1-734-542-9964
<http://www.hirose.com/us/>

THE NETHERLANDS:

HIROSE ELECTRIC EUROPE B.V.
Hogehillweg #8 1101 CC Amsterdam Z-O
Phone : +31-20-6557460
Fax : +31-20-6557469
<http://www.hirose.com/eu/>

GERMANY:

HIROSE ELECTRIC EUROPE B.V. GERMAN BRANCH
Schoenbergstr. 20, 73760 ostfildern
Phone : +49-711-456002-1
Fax : +49-711-456002-299
<http://www.hirose.com/eu/>

GERMANY:

HIROSE ELECTRIC EUROPE B.V. NUREMBERG OFFICE
Neumeyerstrasse 22-26, 90411 Nurnberg
Phone : +49-911 32 68 89 63
Fax : +49-911 32 68 89 69
<http://www.hirose.com/eu/>

GERMANY:

HIROSE ELECTRIC EUROPE B.V. HANOVER OFFICE
Bayernstr. 3, Haus C 30855 Langenhagen, Germany
Phone : +49-511 97 82 61 30
Fax : +49-511 97 82 61 35
<http://www.hirose.com/eu/>

FRANCE:

HIROSE ELECTRIC EUROPE B.V. PARIS OFFICE
Regus La Garenne Colombes, Place de La Belgique,
71 Boulevard National La Garenne Colombes, 92250, France
Phone : +33 (0) 1 7082 3170
Fax : +33 (1) 7082 3101
<http://www.hirose.com/eu/>

UNITED KINGDOM:

HIROSE ELECTRIC EUROPE BV (UK BRANCH)
4 Newton Court, Kelvin Drive, Knowlhill,
Milton Keynes, MK5 8NH
Phone : +44-1908 202050
Fax : +44-1908 202058
<http://www.hirose.com/eu/>

CHINA:

HIROSE ELECTRIC (SHANGHAI) CO., LTD.
1601, Henderson Metropolitan, NO.300, East Nanjing
Road, Huangpu District, Shanghai, China 200001
Phone : +86-21-6391-3355
Fax : +86-21-6391-3335
<http://www.hirose.com/cn/>

CHINA:

HIROSE ELECTRIC (SHANGHAI) CO.,LTD. BEIJING BRANCH
A1001, Ocean International Center, Building 56# East 4th
Ring Middle Road, ChaoYang District, Beijing, 100025
Phone : +86-10-5165-9332
Fax : +86-10-5908-1381
<http://www.hirose.com/cn/>

CHINA:

HIROSE ELECTRIC TECHNOLOGIES (SHENZHEN) CO., LTD.
Room 09-13, 19/F, Office Tower Shun Hing Square, Di Wang Commercial Centre,
5002 Shen Nan Dong Road, Shenzhen City, Guangdong Province, 518008
Phone : +86-755-8207-0851
Fax : +86-755-8207-0873
<http://www.hirose.com/cn/>

HONG KONG:

HIROSE ELECTRIC HONGKONG TRADING CO., LTD.
Room 1001, West Wing, Tsim Sha Tsui Centre, 66
Mody Road, Tsim Sha Tsui East, Kowloon, Hong Kong
Phone : +852-2803-5338
Fax : +852-2591-6560
<http://www.hirose.com/hk/>

TAIWAN:

HIROSE ELECTRIC TAIWAN CO., LTD.
103 8F, No.87, Zhengzhou Rd., Taipei
Phone : +886-2-2555-7377
Fax : +886-2-2555-7350
<http://www.hirose.com/tw/>

KOREA:

HIROSE KOREA CO.,LTD.
250, Huimanggongwon-ro, Siheung-si,
Gyeonggi-do, Korea, 15083
Phone : +82-31-496-7000 or 7124
Fax : +82-31-496-7100
<http://www.hirose.co.kr/>

SINGAPORE:

HIROSE ELECTRIC SINGAPORE PTE. LTD.
10 Anson Road #26-16, International Plaza
079903, Singapore
Phone : +65-6324-6113
Fax : +65-6324-6123
<http://www.hirose.com/sg/>

INDIA:

HIROSE ELECTRIC SINGAPORE PTE. LTD. DELHI LIAISON OFFICE
Office NO.552, Regus-Green Boulevard, Level5, Tower C,
Sec62, Plot B-9A, Block B, Noida, 201301, Uttar Pradesh, India
Phone : +91-12-660-8018
Fax : +91-120-4804949
<http://www.hirose.com/sg/>

INDIA:

HIROSE ELECTRIC SINGAPORE PTE. LTD. BANGALORE LIAISON OFFICE
Unit No-403, 4th Floor, No-84, Barton Centre, Mahatma
Gandhi (MG) Road, Bangalore 560 001, Karnataka, India
Phone : +91-80-4120 1907
Fax : +91-80-4120 9908
<http://www.hirose.com/sg/>

MALAYSIA:

PENANG REPRESENTATIVE OFFICE
1-21-01, Suntech @ Penang Cybercity (1164), Lintang
Mayang Pasir 3,11950, Bayan Baru, Penang, Malaysia.
Phone : +604-619-2564
Fax : +604-619-2574
<http://www.hirose.com/sg/>

THAILAND:

BANGKOK OFFICE (REPRESENTATIVE OFFICE)
Unit 4703, 47th FL., 1 Empire Tower, South Sathorn
Road, Yannawa, Sathorn, Bangkok 10120 Thailand
Phone : +66-2-686-1255
Fax : +66-2-686-3433
<http://www.hirose.com/sg/>



HIROSE ELECTRIC CO.,LTD.

2-6-3,Nakagawa Chuoh,Tsuzuki-Ku,Yokohama-Shi 224-8540,JAPAN
TEL: +81-45-620-3526 Fax: +81-45-591-3726
<http://www.hirose.com>
<http://www.hirose-connectors.com>