

Fast Switching SCR T627..25

250A Avg.
(400 RMS)
Up to 1200 Volts
10-50 μ s

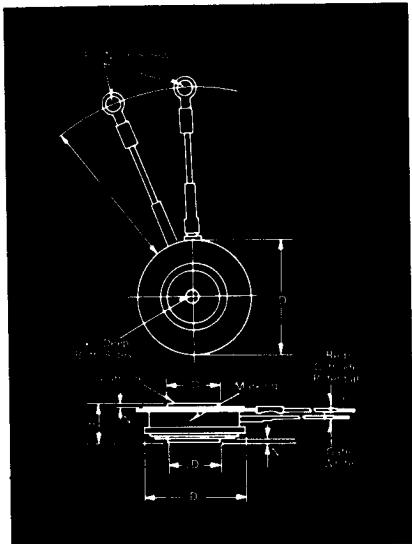

Symbol	Inches		Millimeters	
	Min.	Max.	Min.	Max.
ϕD	1.610	1.650	40.89	41.91
ϕD_1	.745	.755	18.92	19.18
ϕD_2	1.420	1.460	36.07	37.08
H	.500	.560	12.70	14.22
ϕJ	.135	.145	3.43	3.68
J_1	.072	.082	1.83	2.08
L	7.75	8.50	196.85	215.90
N	.030		.76	

Creep Distance—.34 in. min. (8.64 mm).

Strike Distance—.26 in. min. (6.60 mm).

(In accordance with NEMA standards.)

Finish—Nickel Plate.

Approx. Weight—2.3 oz. (66 g).

1. Dimension "H" is clamped dimension.

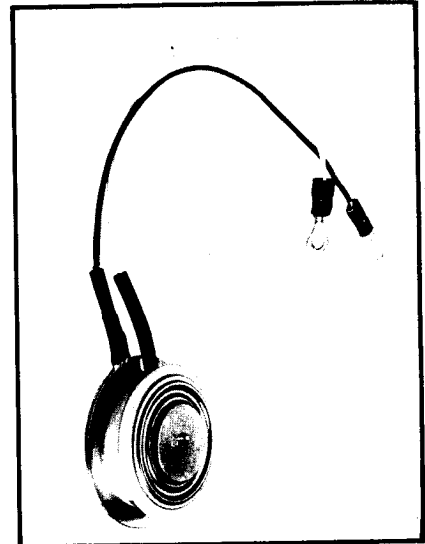

T62 Outline

Features:

- Center fired di/dynamic gate
- High di/dt with soft gate control
- High frequency operation
- Sinusoidal waveform operation to 20 KHz
- Rectangular waveform operation to 20 KHz
- Low dynamic forward voltage drop
- Low switching losses at high frequency

Applications:

- Inverters for
 - Ups
 - Induction Heating
 - Motor Control
- Choppers
- Crowbars

Ordering Information

Type	Voltage		Current		Turn-off		Gate Current		Leads	
	V_{DRM} and V_{RRM} (V)	Code	$I_T(av)$ (A)	Code	t_q μ sec	Code	I_{GT} (ma)	Code	Case	Code
T627	100	01	250	25	10	D	150	4	T62	DN
	200	02								
	300	03								
	400	04								
	500	05								
	600	06								
	700	07								
	800	08								
	900	09								
	1000	10								
	1100	11								
	1200	12								

Example

Obtain optimum device performance for your application by selecting proper Order Code.

Type T627 rated at 250A average with $V_{DRM} = 1000V$, $I_{GT} = 150$ ma, $t_q = 20 \mu$ sec max. and flex leads—order as:

Type	Voltage	Current	Turn Off	Gate Current	Leads
T 6 2 7	1 0	2 5	6	4	D N

FAST SWITCHING
THYRISTORS

**250A Avg.
(400 RMS)
Up to 1200 Volts
10-50 μ s**

**Fast Switching
SCR
T627__25**

Voltage

Blocking State Maximums (T_J = 125°C)

Symbol	100	200	300	400	500	600	700	800	900	1000	1100	1200	
Repetitive peak forward blocking voltage, V	V _{DRM}	100	200	300	400	500	600	700	800	900	1000	1100	1200
Repetitive peak reverse voltage, V	V _{RRM}	100	200	300	400	500	600	700	800	900	1000	1100	1200
Non-repetitive transient peak reverse voltage, V t ≤ 5.0 msec.	V _{RSM}	200	300	400	500	600	700	800	900	1000	1100	1300	
Forward leakage current, mA peak	I _{DRM}	← 25 →											
Reverse leakage current, mA peak	I _{RRM}	← 25 →											

Current

Conducting State Maximums
(T_J = 125°C)

Symbol	T627__25
RMS forward current, A	I _{T(rms)} 400
Ave. forward current, A	I _{T(av)} 250
One-half cycle surge current, A	I _{TSM} 4500
I ² t for fusing (for times ≥ 8.3 ms) A ² sec.	I ² t 84,000
Forward voltage drop at I _{TM} = 625A and T _J = 25°C, V	V _{TM} 1.85
Min. repetitive di/dt, A/μsec	di/dt 300

Switching

(T_J = 25°C)

Symbol	10 to 50
Max. turn-off time, I _T = 150A, T _J = 125°C, di/dt = 12.5 A/μsec, reapplied dv/dt = 20V/μsec linear to 0.8 V _{DRM} , μsec	t _q 10 to 50
Typ. turn-on time, I _T = 100A V _D = 100V, μsec	t _{on} 3.5
Min. critical dv/dt, exponential to V _{DRM} , T _J = 125°C, V/μsec	dv/dt 300
Min. di/dt, A/μsec	di/dt 800

Gate

Maximum Parameters
(T_J = 25°C)

Symbol	150
Gate current to trigger at V _D = 12V, mA	I _{GT} 150
Gate voltage to trigger at V _D = 12V, V	V _{GT} 3
Non-triggering gate voltage, T _J = 125°C, and rated V _{DRM} , V	V _{GDM} 0.15
Peak forward gate current, A	I _{GTM} 4
Peak reverse gate voltage, V	V _{GRM} 5
Peak gate power, Watts	P _{GM} 16
Average gate power, Watts	P _{G(av)} 3

Thermal and Mechanical

Symbol	-40 to +125
Min., Max. oper. junction temp., °C	T _J -40 to +125
Min., Max. storage temp., °C	T _{stg} -40 to +150
Min., Max. Mounting Force, lb.	1000 to 1400
Max. thermal resistance, Double side cooled Junction to case, °C/Watt	R _{θJC} .08
Case to sink, lubricated, °C/Watt	R _{θCS} .02

- ① Consult recommended mounting procedures.
- ② Applies for zero or negative gate bias.
- ③ Per JEDEC RS-397, 5.2.2.1.
- ④ With recommended gate drive.
- ⑤ Higher dv/dt ratings available, consult factory.
- ⑥ Per JEDEC standard RS-397, 5.2.2.6.
- ⑦ For operation with antiparallel diode, consult factory.

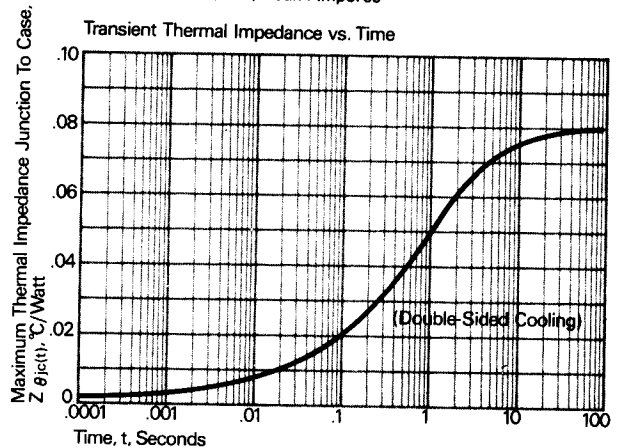
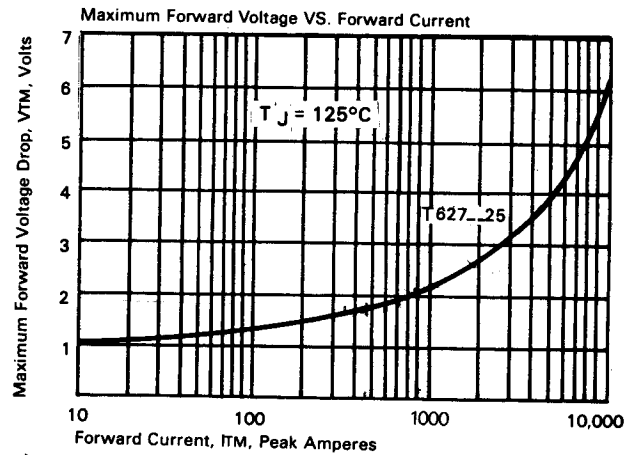

FAST SWITCHING THYRISTORS

Fast Switching SCR T627..25

250A Avg.
(400 RMS)
Up to 1200 Volts
10-50 μ s

Sinusoidal Current Data

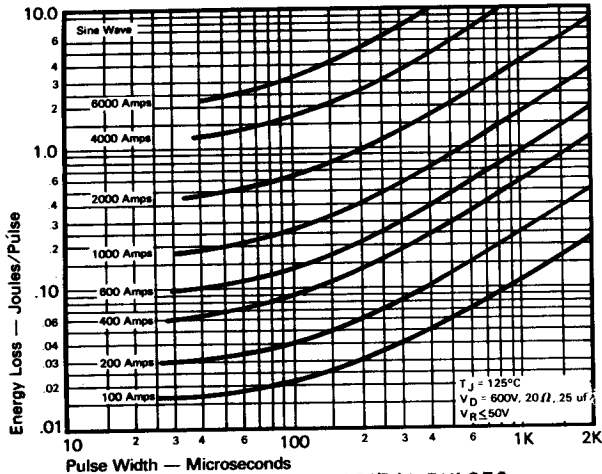

ENERGY PER PULSE FOR SINUSOIDAL PULSES

Trapezoidal Wave Current Data

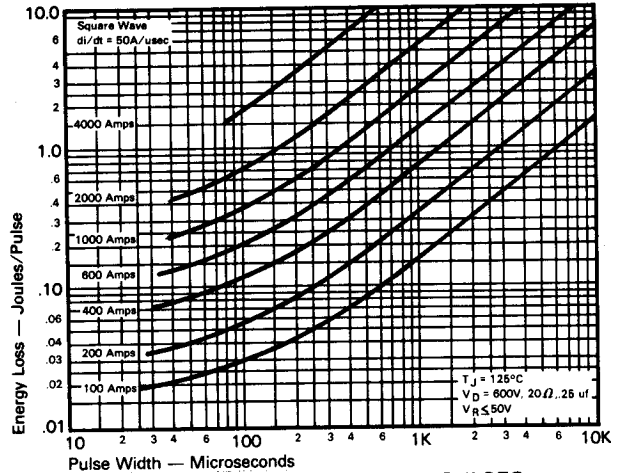

ENERGY PER PULSE FOR TRAPEZOIDAL PULSES
(di/dt = 50A/usec)

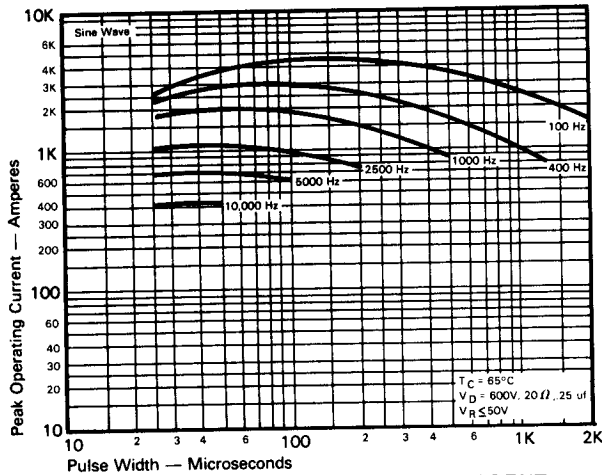

MAXIMUM ALLOWABLE PEAK ON-STATE CURRENT
vs. PULSE WIDTH ($T_C = 65^\circ\text{C}$)

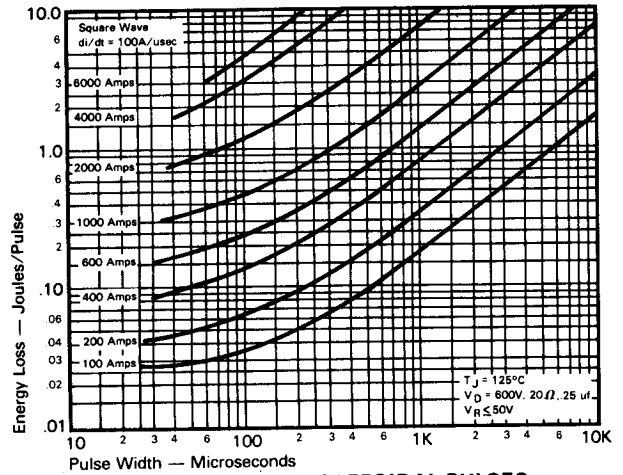

ENERGY PER PULSE FOR TRAPEZOIDAL PULSES
(di/dt = 100A/usec)

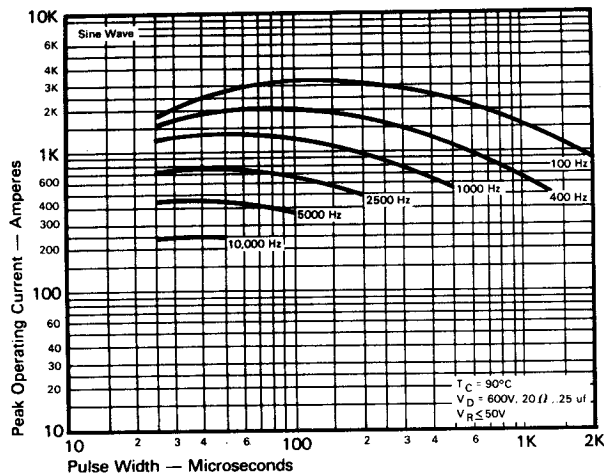

MAXIMUM ALLOWABLE PEAK ON-STATE CURRENT
vs. PULSE WIDTH ($T_C = 90^\circ\text{C}$)

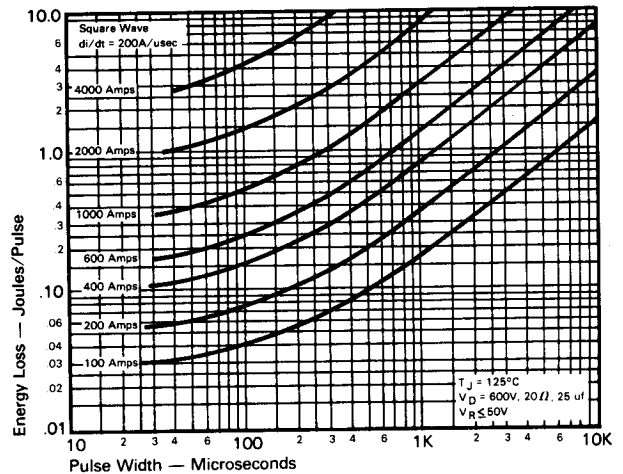

ENERGY PER PULSE FOR TRAPEZOIDAL PULSES
(di/dt = 200A/usec)

250A Avg.
(400 RMS)
Up to 1200 Volts
10-50 μ s

Fast Switching
SCR
T627_25

Trapezoidal Wave Current Data
($T_C = 65^\circ\text{C}$)

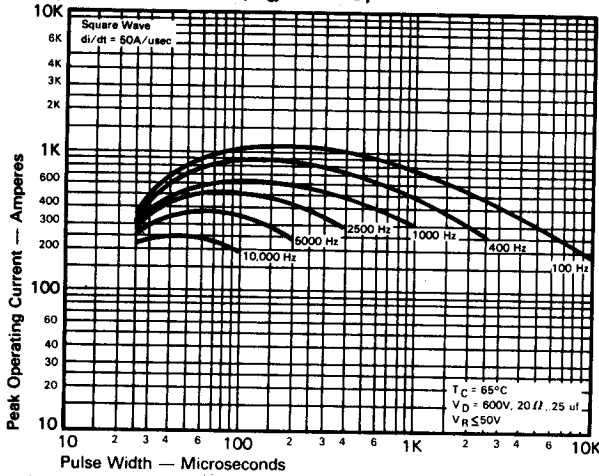

MAXIMUM ALLOWABLE PEAK ON-STATE CURRENT vs. PULSE WIDTH ($di/dt = 50A/usec$)

Trapezoidal Wave Current Data
($T_C = 90^\circ\text{C}$)

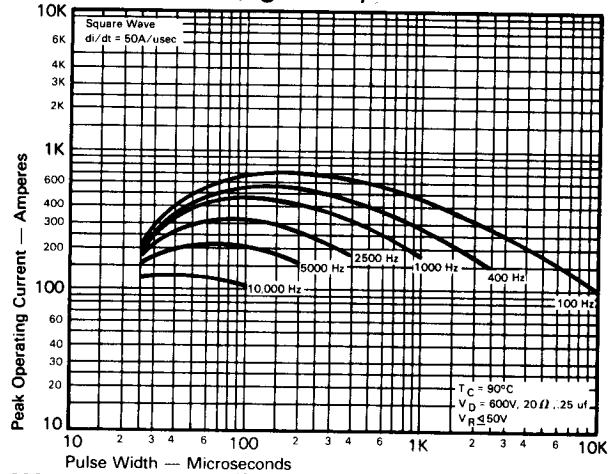

MAXIMUM ALLOWABLE PEAK ON-STATE CURRENT vs. PULSE WIDTH ($di/dt = 50A/usec$)

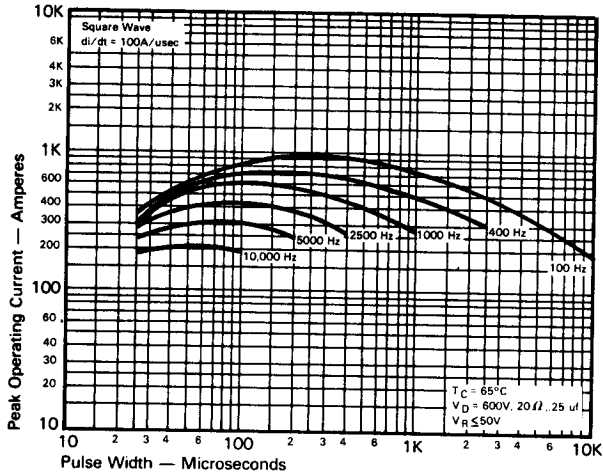

MAXIMUM ALLOWABLE PEAK ON-STATE CURRENT vs. PULSE WIDTH ($di/dt = 100A/usec$)

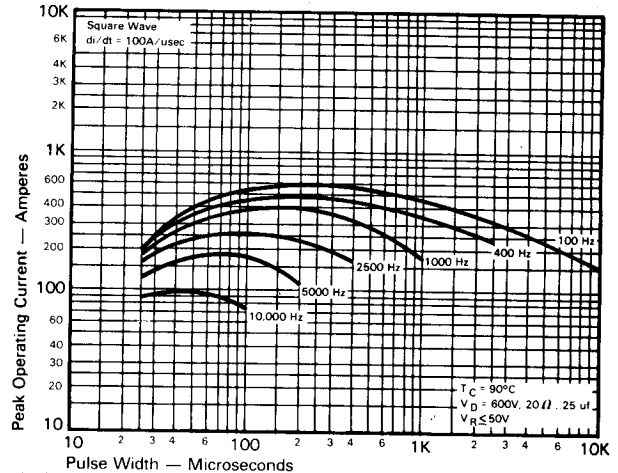

MAXIMUM ALLOWABLE PEAK ON-STATE CURRENT vs. PULSE WIDTH ($di/dt = 100A/usec$)

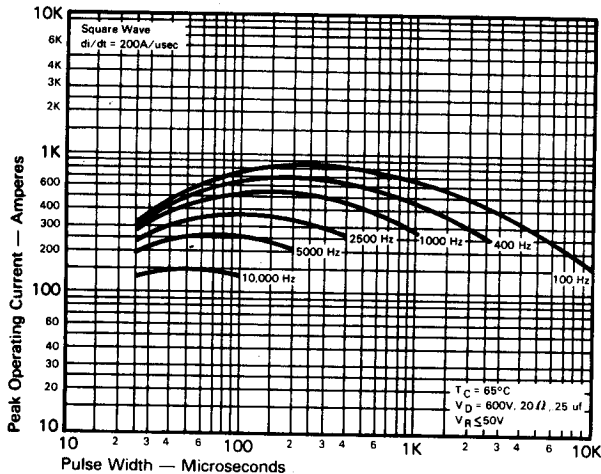

MAXIMUM ALLOWABLE PEAK ON-STATE CURRENT vs. PULSE WIDTH ($di/dt = 200A/usec$)

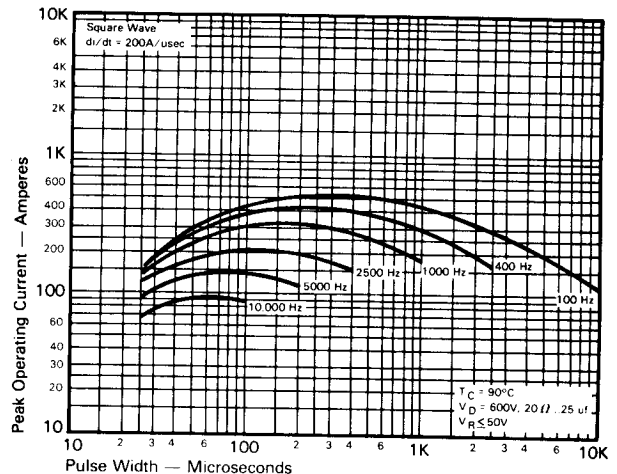

MAXIMUM ALLOWABLE PEAK ON-STATE CURRENT vs. PULSE WIDTH ($di/dt = 200A/usec$)

FAST SWITCHING THYRISTORS

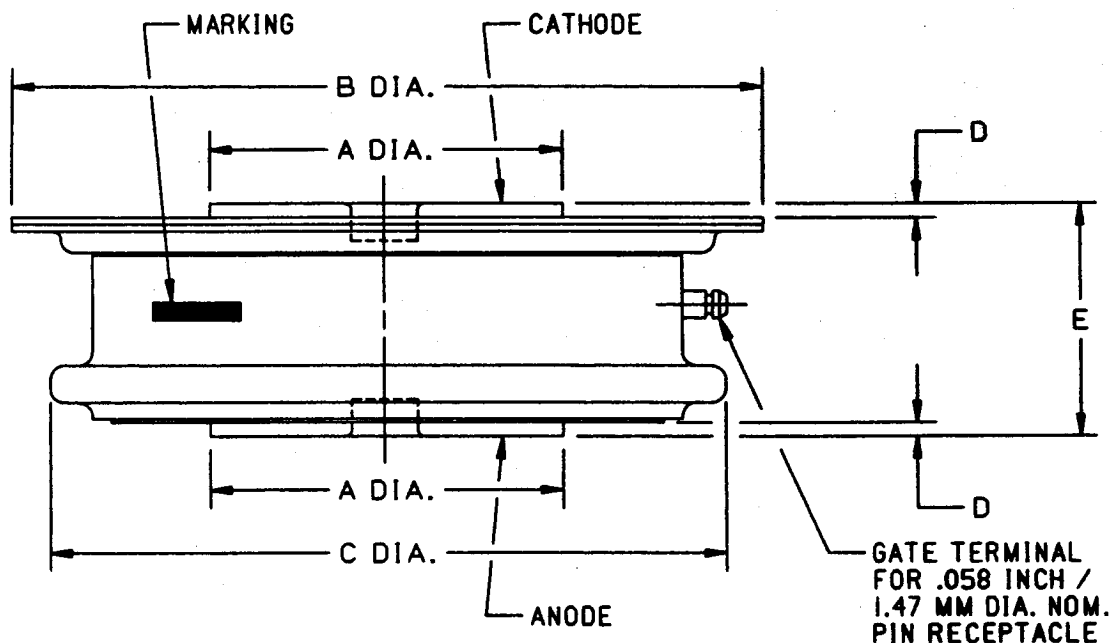
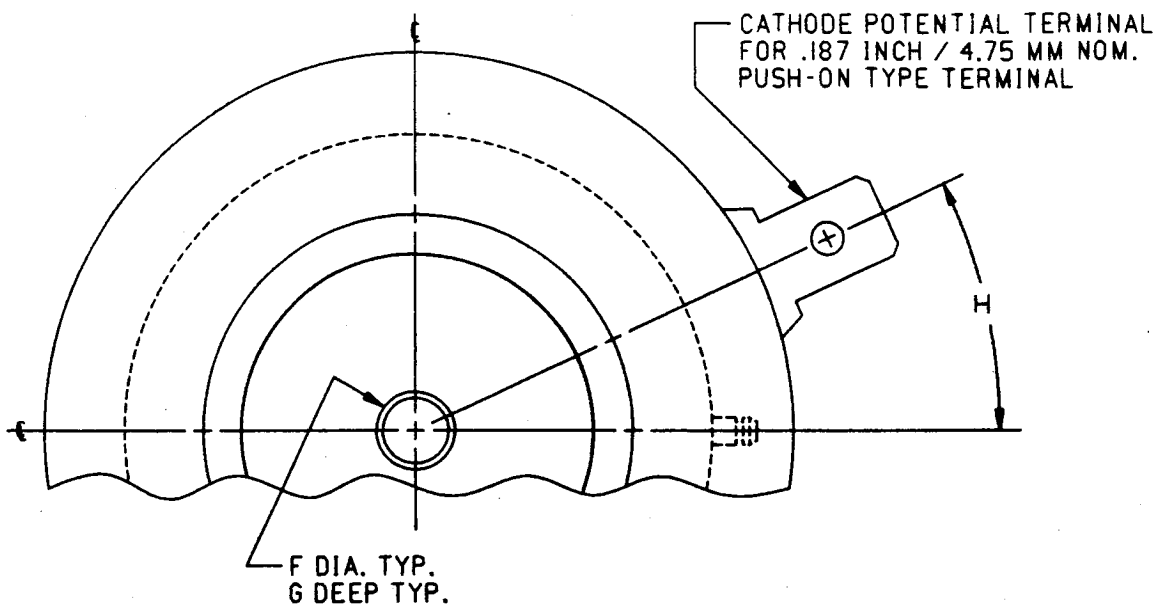

CASE NUMBER T62
NOMINAL DIMENSIONS

STRIKE DISTANCE = .21 INCH / 5.3 MM MIN.
CREEPAGE DISTANCE = .34 INCH / 8.6 MM MIN.

SYM.	A	B	C	D	E	F	G	H
INCHES	.75	1.63	1.44	.030	.500/.565	.140	.080	25°
MM	19.0	41.4	36.6	0.76	12.70/14.35	3.56	2.03	25°

ALL DIMENSIONS ARE REFERENCE