

# Fast Switching SCR T627\_\_20

200A Avg.  
(315 RMS)  
Up to 1200 Volts  
10-50  $\mu$ s

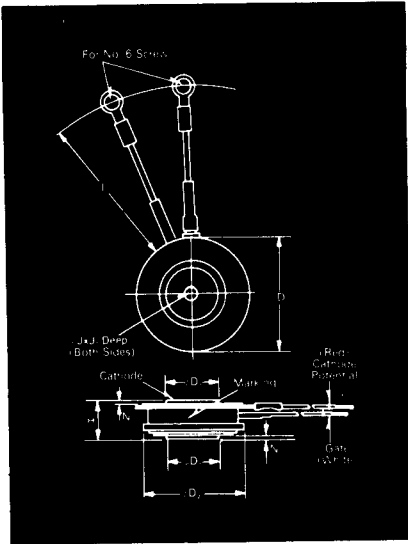

Symbol	Inches		Millimeters	
	Min.	Max.	Min.	Max.
$\phi D$	1.610	1.650	40.89	41.91
$\phi D_1$	.745	.755	18.92	19.18
$\phi D_2$	1.420	1.460	36.07	37.08
H	.500	.560	12.70	14.22
$\phi J$	.135	.145	3.43	3.68
$J_1$	.072	.082	1.83	2.08
L	7.75	8.50	196.85	215.90
N	.030		.76	

Creep Distance—.34 in. min. (8.64 mm).

Strike Distance—.26 in. min. (6.60 mm).

(In accordance with NEMA standards.)

Finish—Nickel Plate.

Approx. Weight—2.3 oz. (66 g).

1. Dimension "H" is clamped dimension.

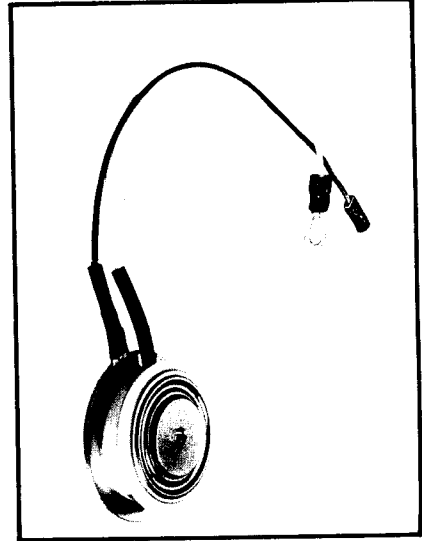

## T62 Outline

### Features:

- Center fired di/dynamic gate
- High di/dt with soft gate control
- High frequency operation
- Sinusoidal waveform operation to 20 KHz
- Rectangular waveform operation to 20 KHz
- Low dynamic forward voltage drop
- Low switching losses at high frequency

### Applications:

- Inverters for
  - Ups
  - Induction Heating
  - Motor Control
- Choppers
- Crowbars

## Ordering Information

Type	Voltage		Current		Turn-off		Gate Current		Leads		
Code	$V_{DRM}$ and $V_{RRM}$ (V)	Code	$I_T(av)$ (A)	Code	$t_q$ $\mu$ sec	Code	$I_{GT}$ (ma)	Code	Case	Code	
T627	100	01	200	20	10	6	150	4	T62	DN	
	200	02			15						7
	300	03			20						8
	400	04			30						8
	500	05			40						4
	600	06			50						3
	700	07									
	800	08									
	900	09									
	1000	10									
	1100	11									
	1200	12									

### Example

Obtain optimum device performance for your application by selecting proper Order Code.

Type T627 rated at 200A average with  $V_{DRM} = 1000V$ ,  $I_{GT} = 150$  ma,  $t_q = 20 \mu$ sec max. and flex leads—order as:

Type	Voltage	Current	Turn Off	Gate Current	Leads
T 6 2 7	1 0	2 0	6	4	D N

\*for 10  $\mu$ sec turn-off, consult factory

**200A Avg.  
(315 RMS)  
Up to 1200 Volts  
10-50  $\mu$ s**

**Fast Switching  
SCR  
T627\_20**

**Voltage**

**Blocking State Maximums** (1) ( $T_J = 125^\circ\text{C}$ )

Repetitive peak forward blocking voltage, V	$V_{DRM}$	100	200	300	400	500	600	700	800	900	1000	1100	1200
Repetitive peak reverse voltage, V	$V_{RRM}$	100	200	300	400	500	600	700	800	900	1000	1100	1200
Non-repetitive transient peak reverse voltage, $t \leq 5.0$ msec, V	$V_{RSM}$	200	300	400	500	600	700	800	900	1000	1100	1200	1300
Forward leakage current, mA peak	$I_{DRM}$	← 25 →											
Reverse leakage current, mA peak	$I_{RRM}$	← 25 →											

**Current**

**Conducting State Maximums**  
( $T_J = 125^\circ\text{C}$ )

Symbol	T627_20
RMS forward current, A	$I_T(\text{rms})$ 315
Ave. forward current, A	$I_T(\text{av})$ 200
One-half cycle surge current(3), A	$I_{TSM}$ 4000
$I^2t$ for fusing (for times $\geq 8.3$ ms) A <sup>2</sup> sec.	$I^2t_f$ 65,000
Forward voltage drop at $I_{TM} = 625\text{A}$ and $T_J = 25^\circ\text{C}$ , V	$V_{TM}$ 2.1
Min. repetitive di/dt(4), A/ $\mu$ sec(1)(4)(5)	di/dt 250

**Switching**

( $T_J = 25^\circ\text{C}$ )

Symbol	
Max. turn-off time, $I_T = 150\text{A}$ , $T_J = 125^\circ\text{C}$ , $di/dt = 12.5$ (1) A/ $\mu$ sec, reapplied $dv/dt = 20\text{V}/\mu$ sec (5) linear to $0.8 V_{DRM}$ , $\mu$ sec.	$t_q$ 10 to 50
Typ. turn-on-time, $I_T = 100\text{A}$ , $V_D = 100\text{V}$ (4), $\mu$ sec	$t_{on}$ 3.5
Min. critical $dv/dt$ , exponential to $V_{DRM}$ , $T_J = 125^\circ\text{C}$ , V/ $\mu$ sec(2)(5)	$dv/dt$ 300
Min. di/dt A/ $\mu$ sec (1)(4)(5)	di/dt 800

**Gate**

**Maximum Parameters**  
( $T_J = 25^\circ\text{C}$ )

Symbol	
Gate current to trigger at $V_D = 12\text{V}$ , mA	$I_{GT}$ 150
Gate voltage to trigger at $V_D = 12\text{V}$ , V	$V_{GT}$ 3
Non-triggering gate voltage, $T_J = 125^\circ\text{C}$ , and rated $V_{DRM}$ , V	$V_{GDM}$ 0.15
Peak forward gate current, A	$I_{GTM}$ 4
Peak reverse gate voltage, V	$V_{GRM}$ 5
Peak gate power, Watts	$P_{GM}$ 16
Average gate power, Watts	$P_{G(av)}$ 3

**Thermal and Mechanical**

Symbol	
Min., Max. oper. junction temp., $^\circ\text{C}$	$T_J$ -40 to +125
Min., Max. storage temp., $^\circ\text{C}$	$T_{stg}$ -40 to +150
Min., Max. Mounting Force, lb.(1)	1000 to 1400
Max. thermal resistance, Double side cooled Junction to case, $^\circ\text{C}/\text{Watt}$	$R_{\theta JC}$ .08
Case to sink, lubricated, $^\circ\text{C}/\text{Watt}$	$R_{\theta CS}$ .02

- (1) Consult recommended mounting procedures.
- (2) Applies for zero or negative gate bias.
- (3) Per JEDEC RS-397, 5.2.2.1.
- (4) With recommended gate drive.
- (5) Higher  $dv/dt$  ratings available, consult factory.
- (6) Per JEDEC standard RS-397, 5.2.2.6.
- (7) For operation with antiparallel diode, consult factory.

Maximum Forward Voltage VS. Forward Current

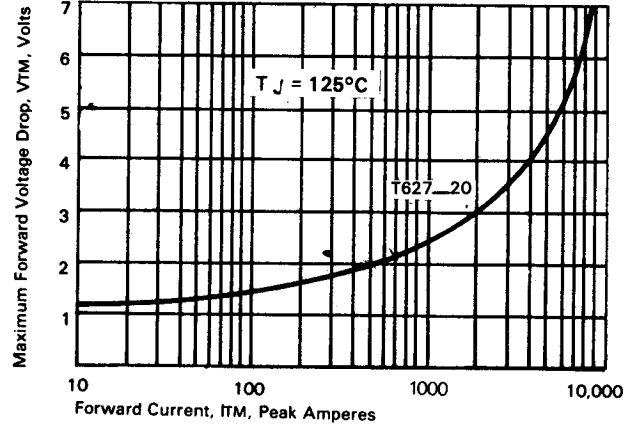

Transient Thermal Impedance vs. Time

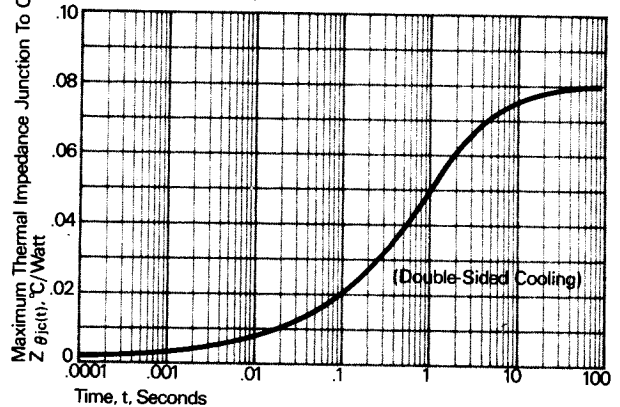

FAST SWITCHING THYRISTORS

# Fast Switching SCR T627-20

200A Avg.  
(315 RMS)  
Up to 1200 Volts  
10-50  $\mu$ s

## Sinusoidal Current Data

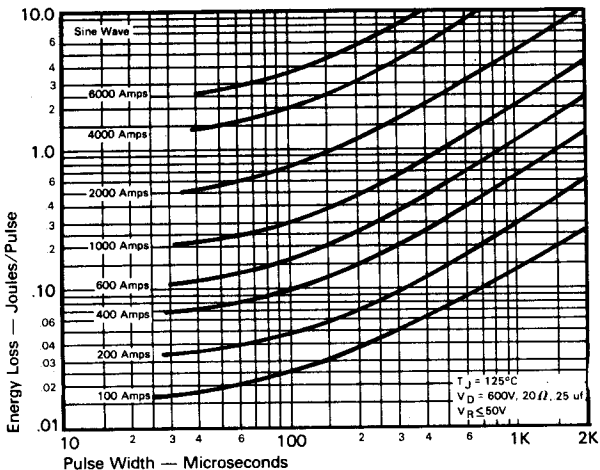

ENERGY PER PULSE FOR SINUSOIDAL PULSES

## Trapezoidal Wave Current Data

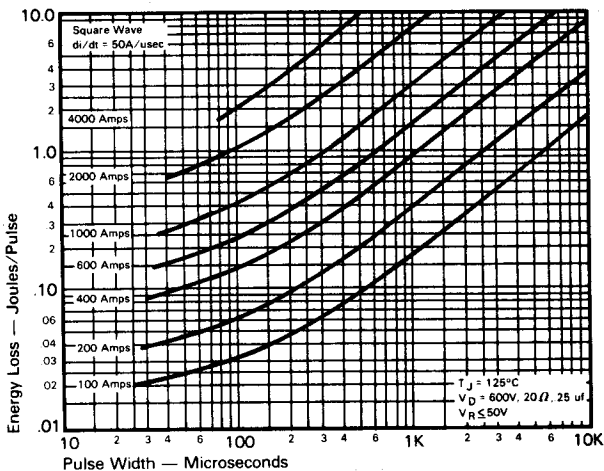

ENERGY PER PULSE FOR TRAPEZOIDAL PULSES  
( $di/dt = 50\text{A}/\mu\text{sec}$ )

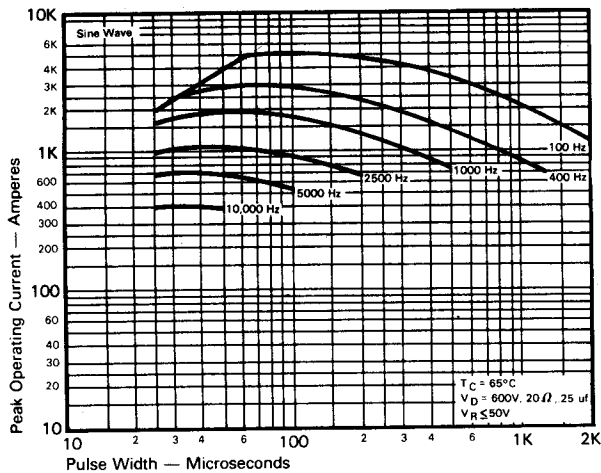

MAXIMUM ALLOWABLE PEAK ON-STATE CURRENT  
vs. PULSE WIDTH ( $T_C = 65^\circ\text{C}$ )

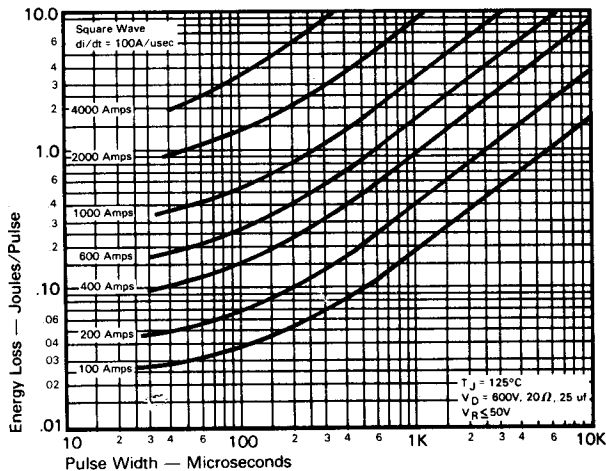

ENERGY PER PULSE FOR TRAPEZOIDAL PULSES  
( $di/dt = 100\text{A}/\mu\text{sec}$ )

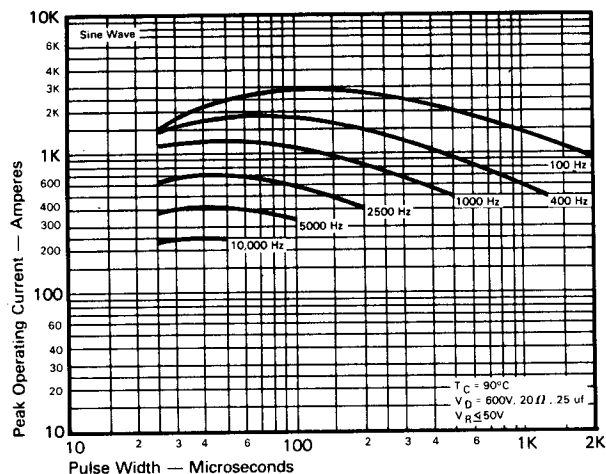

MAXIMUM ALLOWABLE PEAK ON-STATE CURRENT  
vs. PULSE WIDTH ( $T_C = 90^\circ\text{C}$ )

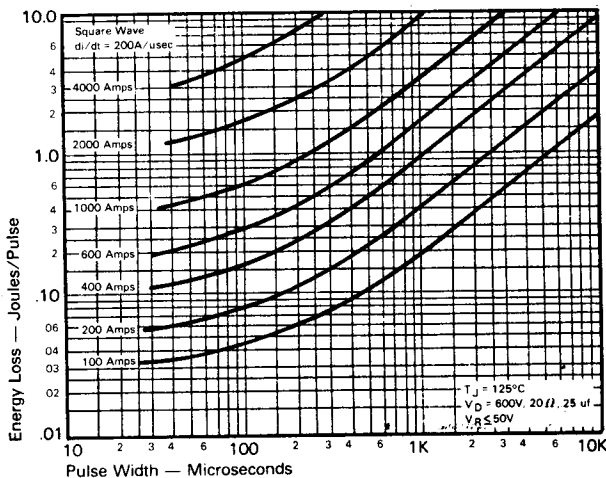

ENERGY PER PULSE FOR TRAPEZOIDAL PULSES  
( $di/dt = 200\text{A}/\mu\text{sec}$ )

200A Avg.  
(315 RMS)  
Up to 1200 Volts  
10-50  $\mu$ s

Fast Switching  
SCR  
T627-20

**Trapezoidal Wave Current Data**  
( $T_C = 65^\circ C$ )

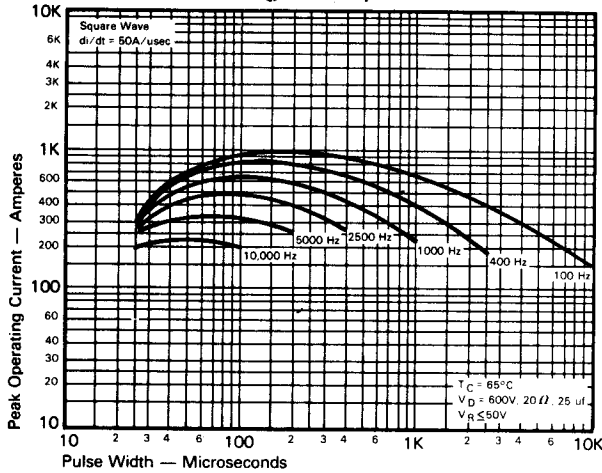

**MAXIMUM ALLOWABLE PEAK ON-STATE CURRENT vs. PULSE WIDTH ( $di/dt = 50A/usec$ )**

**Trapezoidal Wave Current Data**  
( $T_C = 90^\circ C$ )

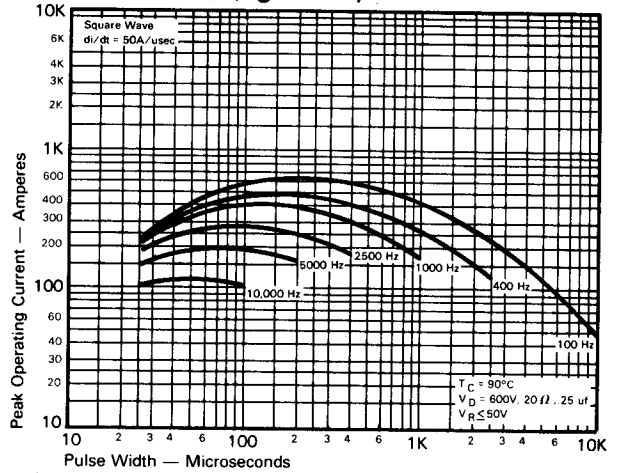

**MAXIMUM ALLOWABLE PEAK ON-STATE CURRENT vs. PULSE WIDTH ( $di/dt = 50A/usec$ )**

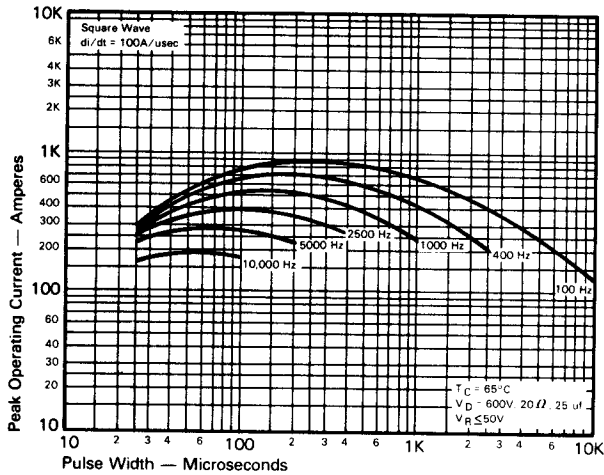

**MAXIMUM ALLOWABLE PEAK ON-STATE CURRENT vs. PULSE WIDTH ( $di/dt = 100A/usec$ )**

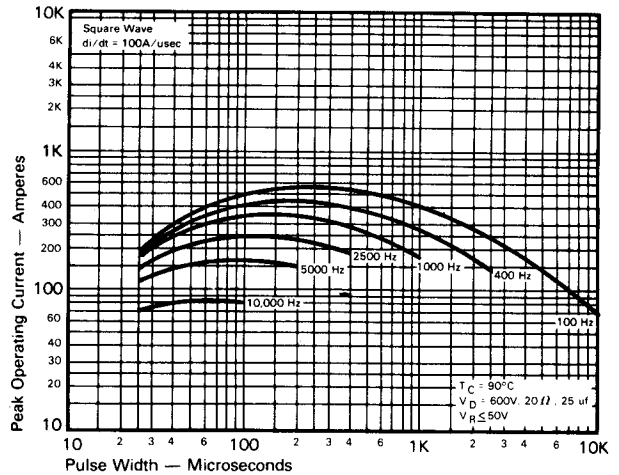

**MAXIMUM ALLOWABLE PEAK ON-STATE CURRENT vs. PULSE WIDTH ( $di/dt = 100A/usec$ )**

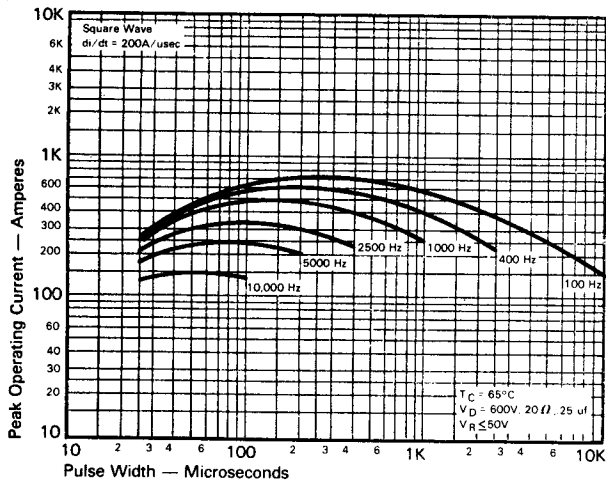

**MAXIMUM ALLOWABLE PEAK ON-STATE CURRENT vs. PULSE WIDTH ( $di/dt = 200A/usec$ )**

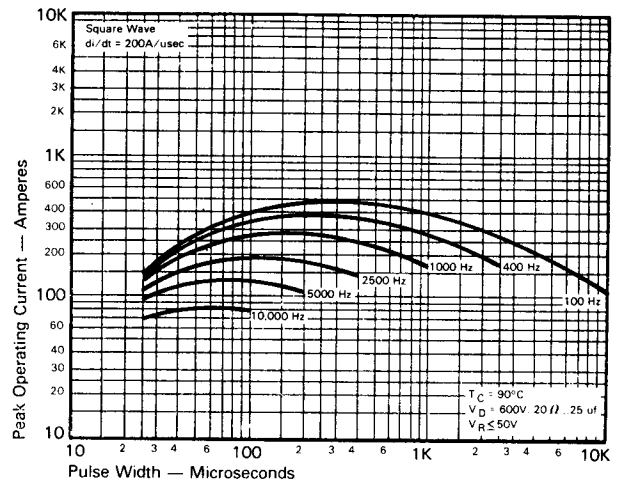

**MAXIMUM ALLOWABLE PEAK ON-STATE CURRENT vs. PULSE WIDTH ( $di/dt = 200A/usec$ )**

FAST SWITCHING THYRISTORS

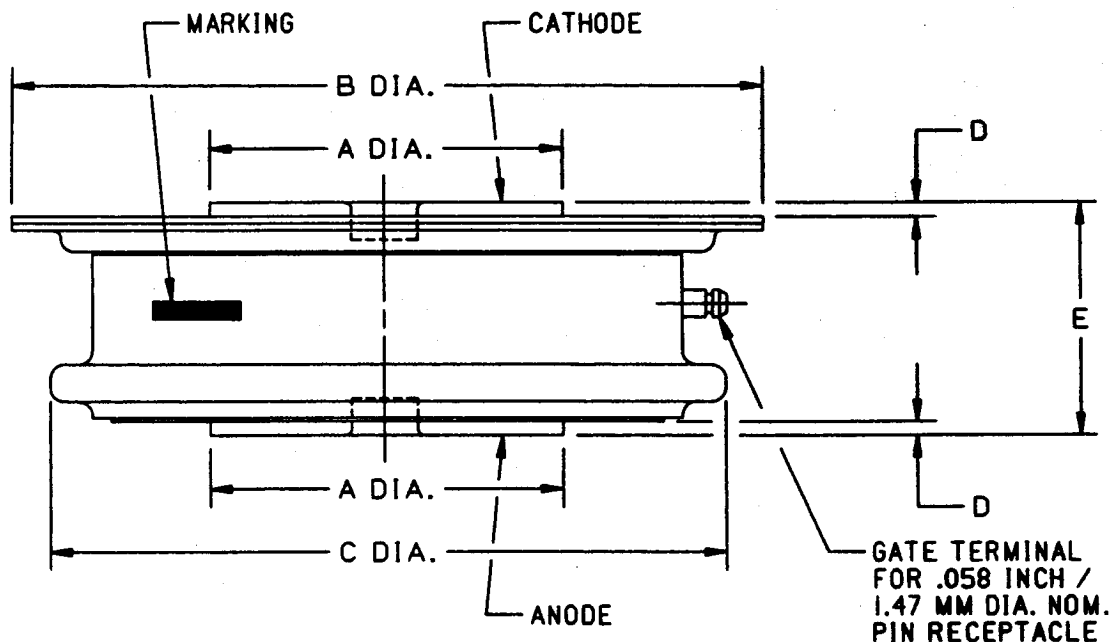
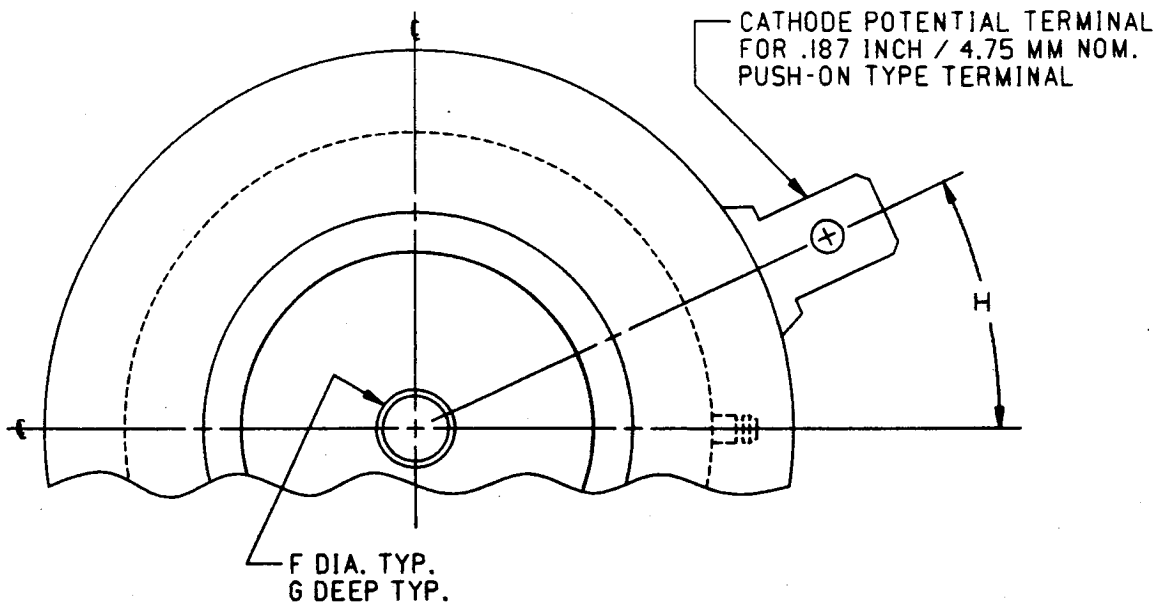

CASE NUMBER T62  
NOMINAL DIMENSIONS

STRIKE DISTANCE = .21 INCH / 5.3 MM MIN.  
CREEPAGE DISTANCE = .34 INCH / 8.6 MM MIN.

SYM.	A	B	C	D	E	F	G	H
INCHES	.75	1.63	1.44	.030	.500/.565	.140	.080	25°
MM	19.0	41.4	36.6	0.76	12.70/14.35	3.56	2.03	25°

ALL DIMENSIONS ARE REFERENCE