

High-performance MEMS audio sensor: fully differential analog bottom-port microphone

Datasheet - production data

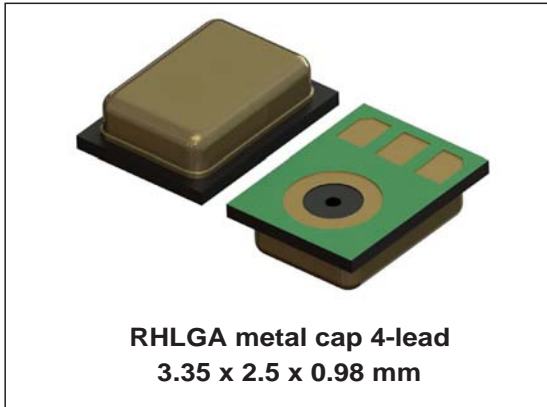

Description

The MP23AB01DM is a compact, low-power microphone built with a capacitive sensing element and an IC interface.

The sensing element, capable of detecting acoustic waves, is manufactured using a specialized silicon micromachining process to produce audio sensors.

The MP23AB01DM has an acoustic overload point of 130 dB SPL with a typical 64 dB signal-to-noise ratio.

The MP23AB01DM has fully differential output in order to minimize common-mode noise.

The sensitivity of MP23AB01DM is -38 dBV ± 3 dB @ (0 dB = 1 V/Pa), 1 kHz.

The MP23AB01DM is available in a package compliant with reflow soldering and is guaranteed to operate over an extended temperature range from -40 °C to +85 °C.

Features

- Single supply voltage operation
- Fully differential output
- Omnidirectional sensitivity
- High signal-to-noise ratio
- High bandwidth
- High acoustic overload point
- Package compliant with reflow soldering
- High RF immunity

Table 1. Device summary

Order code	Temperature range (°C)	Package	Packing
MP23AB01DM	-40 to +85	(3.35 x 2.5 x 0.98) mm	Tray
MP23AB01DMTR	-40 to +85	(3.35 x 2.5 x 0.98) mm	Tape and reel

Contents

1	Pin description	3
2	Acoustic and electrical specifications	4
	2.1 Acoustic and electrical characteristics	4
	2.2 Frequency response	5
3	Absolute maximum ratings	6
4	Application recommendations	7
5	Package information	8
	5.1 Soldering information	8
	5.2 RHLGA metal cap 4-lead package information	9
	5.3 RHLGA metal cap 4-lead packing information	11
6	Revision history	12

1 Pin description

Figure 1. Pin connections

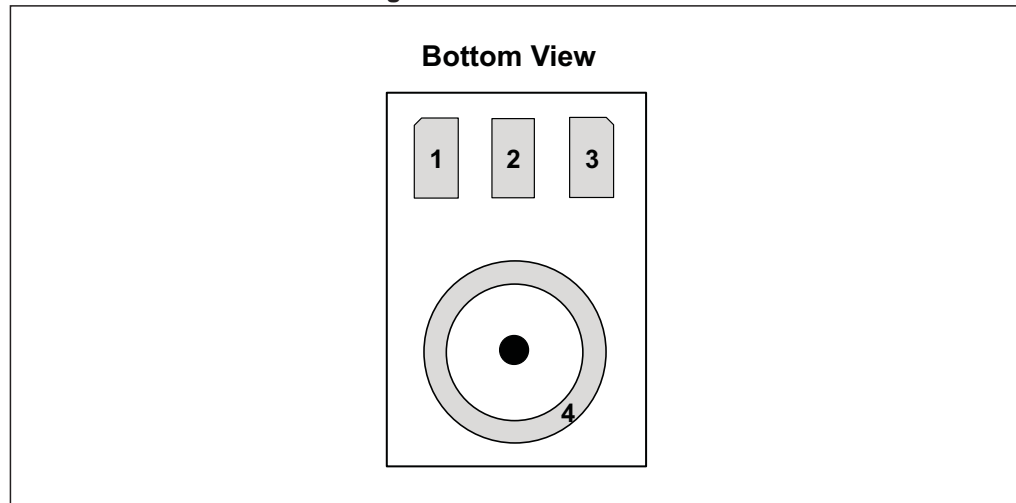

Table 2. Pin description

Pin n°	Pin name	Function
1	Vdd	Supply voltage
2	OUT-	Negative output signal
3	OUT+	Positive output signal
4	Ground	Ground

2 Acoustic and electrical specifications

2.1 Acoustic and electrical characteristics

The values listed in the tables below are specified for Vdd = 2.7 V, no load, Tamb = 25 °C unless otherwise specified.

Table 3. Acoustic and electrical characteristics

Symbol	Parameter	Test condition	Min.	Typ. ⁽¹⁾	Max.	Unit
Vdd	Supply voltage ⁽²⁾		2.1		3.6	V
Idd	Current consumption				250	μA
So	Sensitivity	@ 1 kHz (0dB =1V/Pa)	-41	-38	-35	dBV
SNR	Signal-to-noise ratio	A-weighted		64		dB(A)
PSR	Power Supply Rejection	20 Hz - 20 kHz, 100 mVpp sine wave		-85		dB
AOP	Acoustic Overload Point		125		130	dB SPL
Zout	Output Impedance				400	Ω
Cload	Load capacitance				300	pF
Rload	Load resistance		10			kΩ
Top	Operating temperature range		-40		+85	°C

1. Typical specifications are not guaranteed

2. Minimum supply 2.1 V

Table 4. Typical distortion specifications at 1 kHz sine wave input

Parameter	Test condition	Typ. value
THD+N	94 dB SPL	< 0.5%
	120 dB SPL	< 4%
	130 dB SPL	< 10%

2.2 Frequency response

Figure 2. Typical free field frequency response normalized at 1 kHz

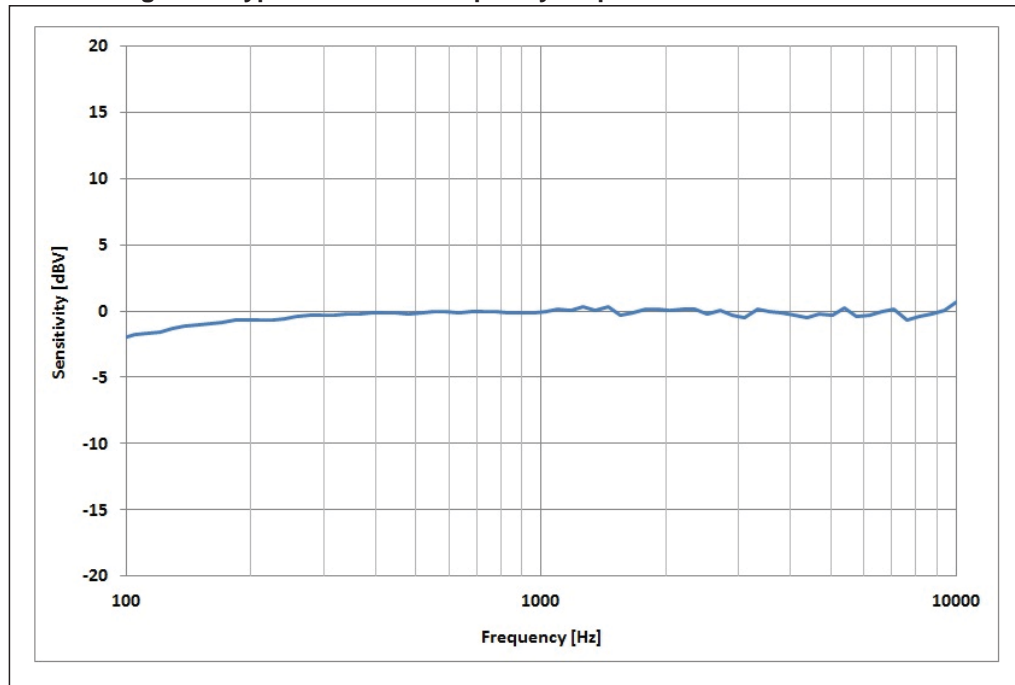

3 Absolute maximum ratings

Stresses above those listed as “Absolute maximum ratings” may cause permanent damage to the device. This is a stress rating only and functional operation of the device under these conditions is not implied. Exposure to maximum rating conditions for extended periods may affect device reliability.

Table 5. Absolute maximum ratings

Symbol	Ratings	Maximum value	Unit
Vdd	Supply voltage	-0.5 to 4.8	V
T _{STG}	Storage temperature range	-40 to +105	°C



This device is sensitive to mechanical shock, improper handling can cause permanent damage to the part.



This device is sensitive to electrostatic discharge (ESD), improper handling can cause permanent damage to the part.

4 Application recommendations

Figure 3. MP23AB01DM electrical connections and external component values

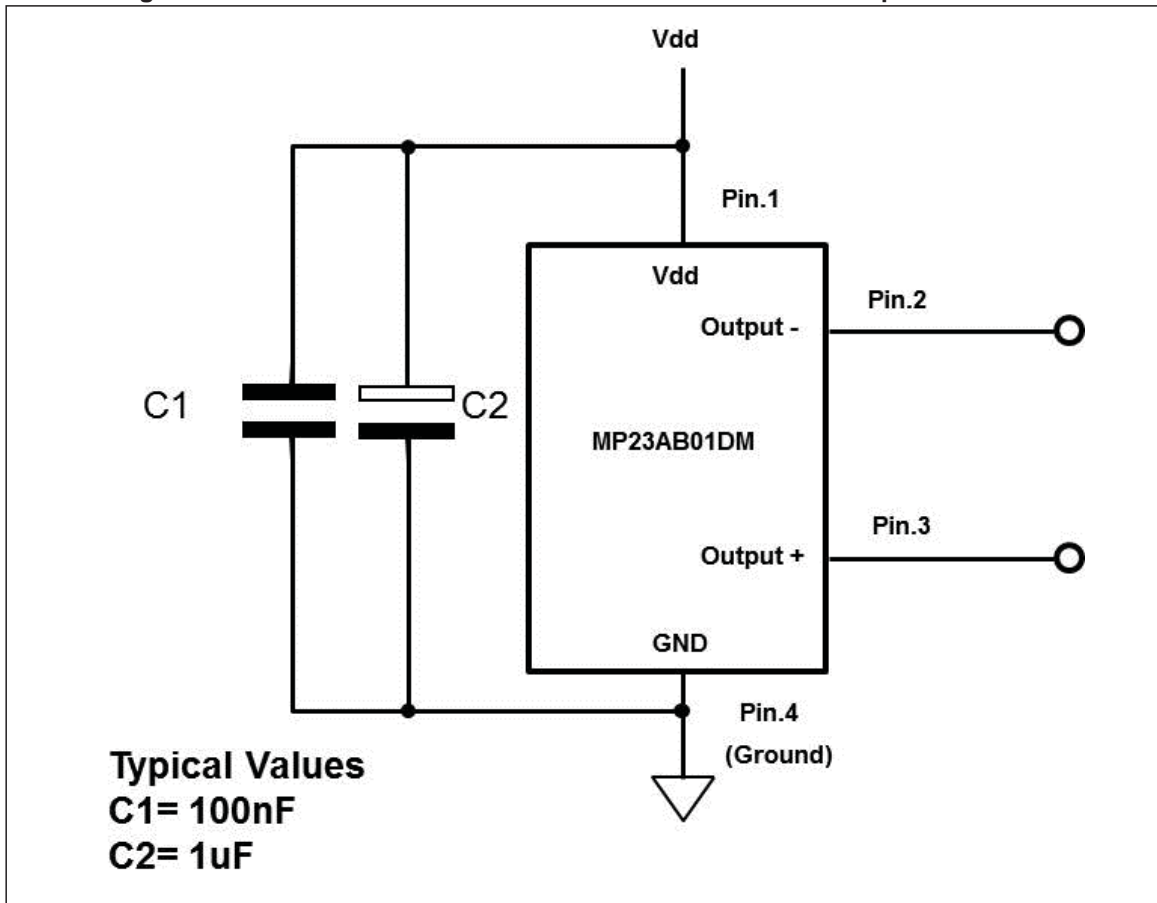

5 Package information

In order to meet environmental requirements, ST offers these devices in different grades of ECOPACK® packages, depending on their level of environmental compliance. ECOPACK® specifications, grade definitions and product status are available at: www.st.com. ECOPACK® is an ST trademark.

5.1 Soldering information

Figure 4. Recommended soldering profile limits

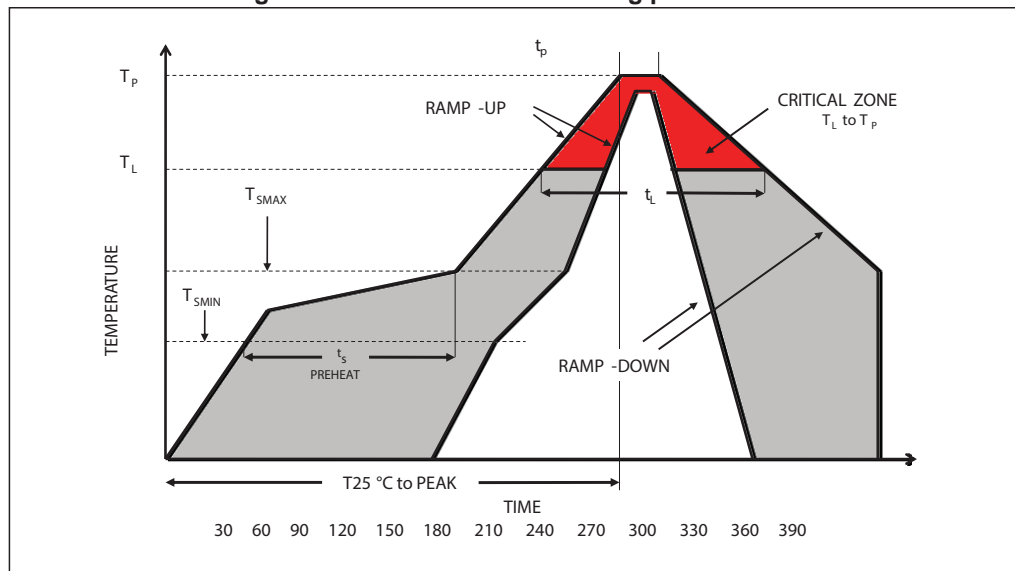
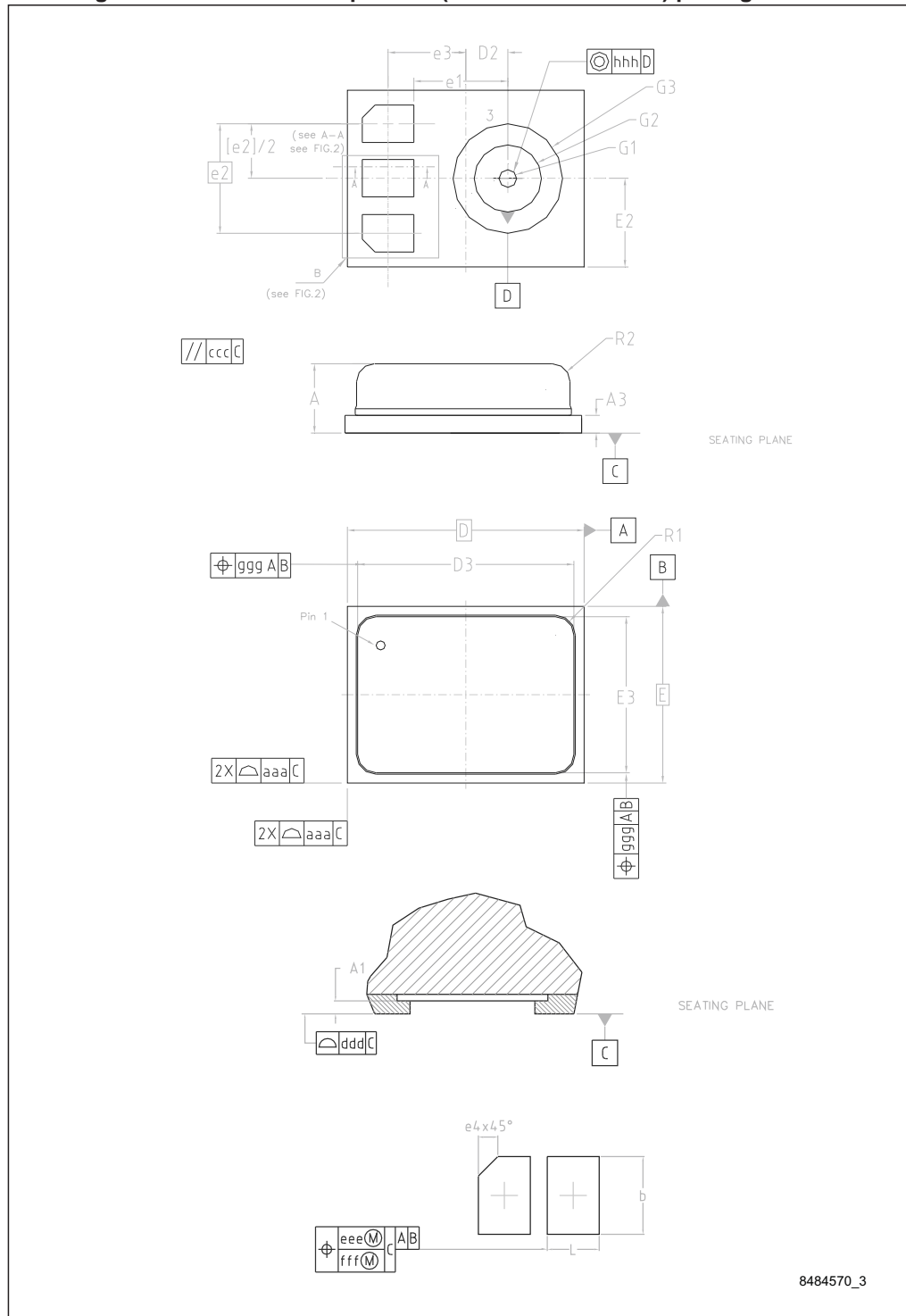

Table 6. Recommended soldering profile limits

Description	Parameter	Pb free
Average ramp rate	T_L to T_P	3 °C/sec max
Preheat		
Minimum temperature	T_{SMIN}	150 °C
Maximum temperature	T_{SMAX}	200 °C
Time (T_{SMIN} to T_{SMAX})	t_s	60 sec to 120 sec
Ramp-up rate	T_{SMAX} to T_L	
Time maintained above liquidus temperature	t_L	60 sec to 150 sec
Liquidus temperature	T_L	217 °C
Peak temperature	T_P	260 °C max
Time within 5 °C of actual peak temperature		20 sec to 40 sec
Ramp-down rate		6 °C/sec max
Time 25 °C ($t = 25$ °C) to peak temperature		8 minutes max

5.2 RHLGA metal cap 4-lead package information

Figure 5. RHLGA metal cap 4-lead (3.35 x 2.5 x 0.98 mm) package outline



8484570_3

Table 7. RHLGA metal cap 4-lead (3.35 x 2.5 x 0.98 mm) package mechanical data

Reference	Dimensions (mm)		
	Min.	Typ.	Max.
A	0.88	0.98	1.08
A1	0.00	-	0.025
A3	0.21	0.25	0.29
b	0.63	0.73	0.83
D	3.25	3.35	3.45
D2	0.495	0.595	0.695
D3	2.94	3.04	3.14
E	2.4	2.5	2.6
E3	2.09	2.19	2.29
e1	1.18	1.33	1.48
e2	1.41	1.56	1.71
e3	0.95	1.1	1.25
e4	-	0.18	-
G1	0.20	0.25	0.30
G2	0.8	0.95	1.1
G3	1.4	1.55	1.7
L	0.43	0.53	0.63
R1	-	0.28	-
R2	-	0.25	-

5.3 RHLGA metal cap 4-lead packing information

Figure 6. Carrier tape mechanical specifications

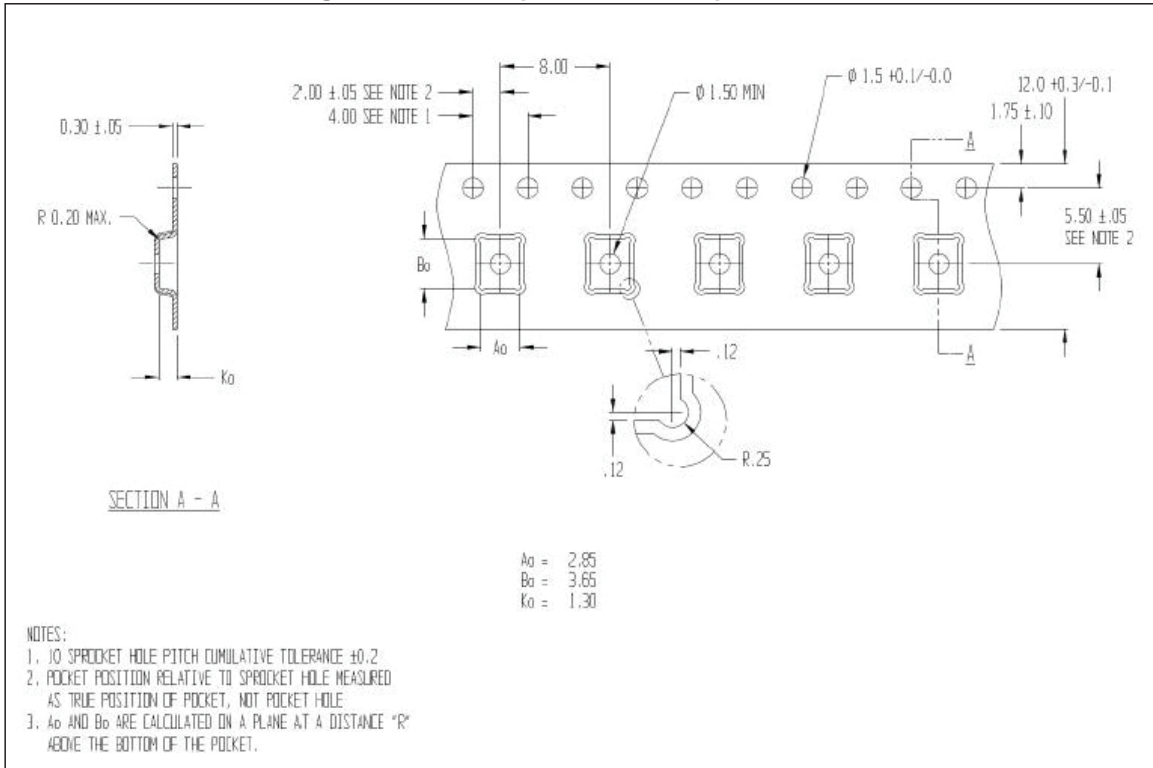

6 Revision history

Table 8. Document revision history

Date	Revision	Changes
19-Apr-2016	1	Initial release