

Features

- Advanced Process Technology
- Ultra Low On-Resistance
- 175°C Operating Temperature
- Fast Switching
- Repetitive Avalanche Allowed up to Tjmax

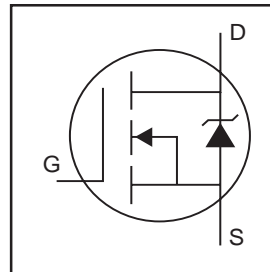

$V_{DSS} = 55V$
$R_{DS(on)} = 24.5m\Omega$
$I_D = 30A$

Description

Specifically designed for Automotive applications, this HEXFET® Power MOSFET utilizes the latest processing techniques to achieve extremely low on-resistance per silicon area. Additional features of this design are a 175°C junction operating temperature, fast switching speed and improved repetitive avalanche rating. These features combine to make this design an extremely efficient and reliable device for use in Automotive applications and a wide variety of other applications.

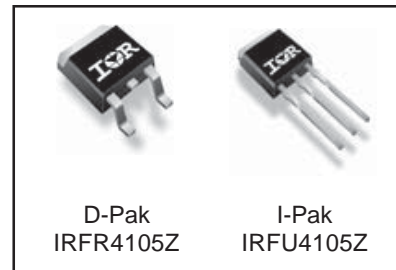

Absolute Maximum Ratings

	Parameter	Max.	Units
$I_D @ T_C = 25^\circ C$	Continuous Drain Current, $V_{GS} @ 10V$ (Silicon Limited)	30	A
$I_D @ T_C = 100^\circ C$	Continuous Drain Current, $V_{GS} @ 10V$	21	
I_{DM}	Pulsed Drain Current ①	120	
$P_D @ T_C = 25^\circ C$	Power Dissipation	48	W
	Linear Derating Factor	0.32	W/°C
V_{GS}	Gate-to-Source Voltage	± 20	V
E_{AS} (Thermally limited)	Single Pulse Avalanche Energy ②	29	mJ
E_{AS} (Tested)	Single Pulse Avalanche Energy Tested Value ③	46	
I_{AR}	Avalanche Current ④	See Fig.12a, 12b, 15, 16	A
E_{AR}	Repetitive Avalanche Energy ⑤		mJ
T_J	Operating Junction and	-55 to + 175	°C
T_{STG}	Storage Temperature Range		
	Soldering Temperature, for 10 seconds	300 (1.6mm from case)	
	Mounting Torque, 6-32 or M3 screw	10 lbf•in (1.1N•m)	

Thermal Resistance

	Parameter	Typ.	Max.	Units
$R_{\theta JC}$	Junction-to-Case	—	3.12	°C/W
$R_{\theta JA}$	Junction-to-Ambient (PCB mount) ⑥	—	40	
$R_{\theta JA}$	Junction-to-Ambient	—	110	

HEXFET® is a registered trademark of International Rectifier.
www.irf.com

Electrical Characteristics @ T_J = 25°C (unless otherwise specified)

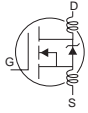
	Parameter	Min.	Typ.	Max.	Units	Conditions
V _{(BR)DSS}	Drain-to-Source Breakdown Voltage	55	—	—	V	V _{GS} = 0V, I _D = 250μA
ΔV _{(BR)DSS/ΔT_J}	Breakdown Voltage Temp. Coefficient	—	0.053	—	V/°C	Reference to 25°C, I _D = 1mA
R _{DS(on)}	Static Drain-to-Source On-Resistance	—	19	24.5	mΩ	V _{GS} = 10V, I _D = 18A ③
V _{GS(th)}	Gate Threshold Voltage	2.0	—	4.0	V	V _{DS} = V _{GS} , I _D = 250μA
g _{fs}	Forward Transconductance	16	—	—	S	V _{DS} = 15V, I _D = 18A
I _{DSS}	Drain-to-Source Leakage Current	—	—	20	μA	V _{DS} = 55V, V _{GS} = 0V
		—	—	250		V _{DS} = 55V, V _{GS} = 0V, T _J = 125°C
I _{GSS}	Gate-to-Source Forward Leakage	—	—	200	nA	V _{GS} = 20V
	Gate-to-Source Reverse Leakage	—	—	-200		V _{GS} = -20V
Q _g	Total Gate Charge	—	18	27	nC	I _D = 18A
Q _{gs}	Gate-to-Source Charge	—	5.3	—		V _{DS} = 44V
Q _{gd}	Gate-to-Drain ("Miller") Charge	—	7.0	—		V _{GS} = 10V ③
t _{d(on)}	Turn-On Delay Time	—	10	—	ns	V _{DD} = 28V
t _r	Rise Time	—	40	—		I _D = 18A
t _{d(off)}	Turn-Off Delay Time	—	26	—		R _G = 24.5 Ω
t _f	Fall Time	—	24	—		V _{GS} = 10V ③
L _D	Internal Drain Inductance	—	4.5	—	nH	Between lead, 6mm (0.25in.) from package and center of die contact
L _S	Internal Source Inductance	—	7.5	—		
C _{iss}	Input Capacitance	—	740	—	pF	V _{GS} = 0V
C _{oss}	Output Capacitance	—	140	—		V _{DS} = 25V
C _{rss}	Reverse Transfer Capacitance	—	74	—		f = 1.0MHz
C _{oss}	Output Capacitance	—	450	—		V _{GS} = 0V, V _{DS} = 1.0V, f = 1.0MHz
C _{oss}	Output Capacitance	—	110	—		V _{GS} = 0V, V _{DS} = 44V, f = 1.0MHz
C _{oss eff.}	Effective Output Capacitance	—	180	—		V _{GS} = 0V, V _{DS} = 0V to 44V ④

Source-Drain Ratings and Characteristics

	Parameter	Min.	Typ.	Max.	Units	Conditions
I _S	Continuous Source Current (Body Diode)	—	—	30	A	MOSFET symbol showing the integral reverse p-n junction diode.
I _{SM}	Pulsed Source Current (Body Diode) ①	—	—	120		
V _{SD}	Diode Forward Voltage	—	—	1.3	V	T _J = 25°C, I _S = 18A, V _{GS} = 0V ③
t _{rr}	Reverse Recovery Time	—	19	29	ns	T _J = 25°C, I _F = 18A, V _{DD} = 28V
Q _{rr}	Reverse Recovery Charge	—	14	21	nC	di/dt = 100A/μs ③
t _{on}	Forward Turn-On Time	Intrinsic turn-on time is negligible (turn-on is dominated by LS+LD)				

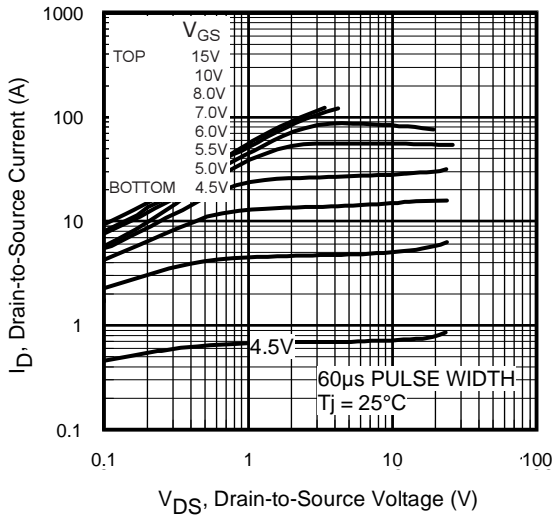

Fig 1. Typical Output Characteristics

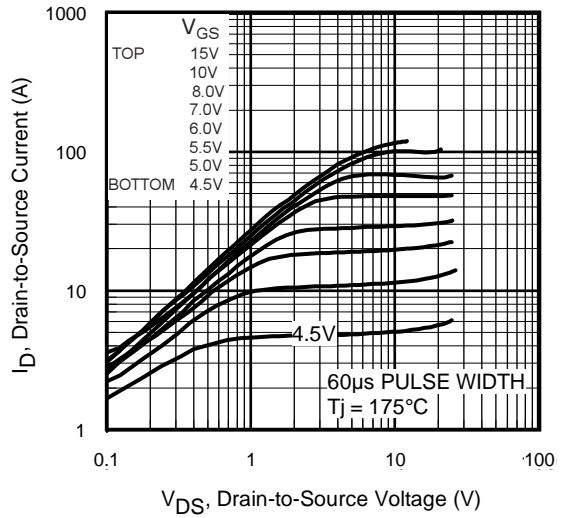

Fig 2. Typical Output Characteristics

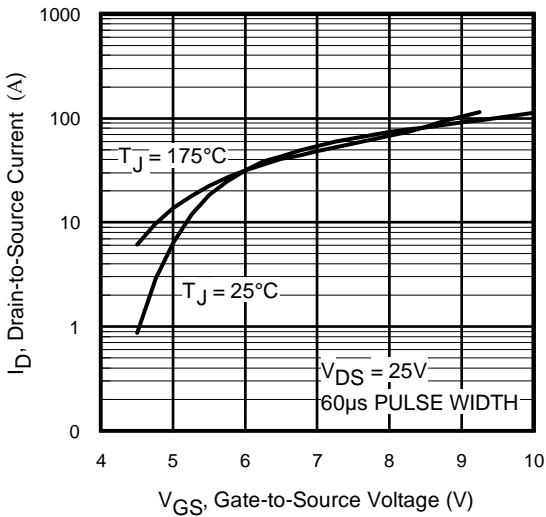

Fig 3. Typical Transfer Characteristics

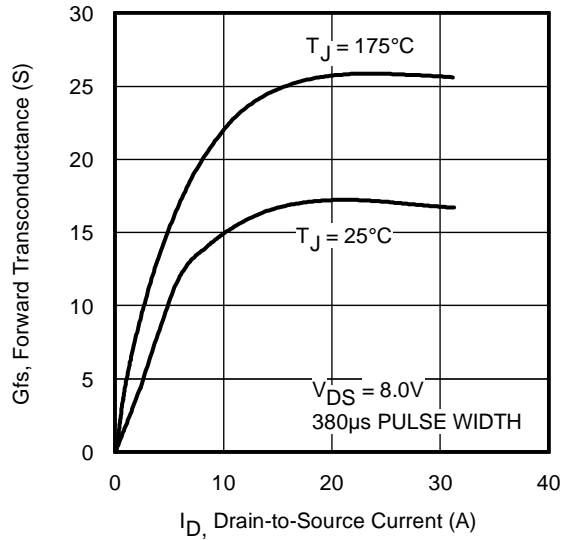

Fig 4. Typical Forward Transconductance Vs. Drain Current

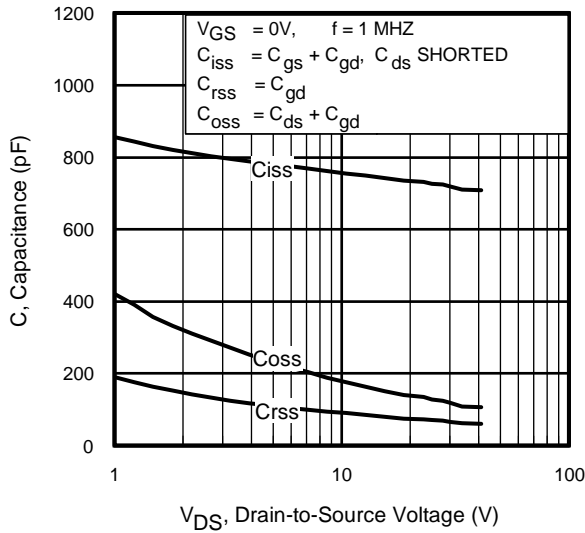

Fig 5. Typical Capacitance Vs. Drain-to-Source Voltage

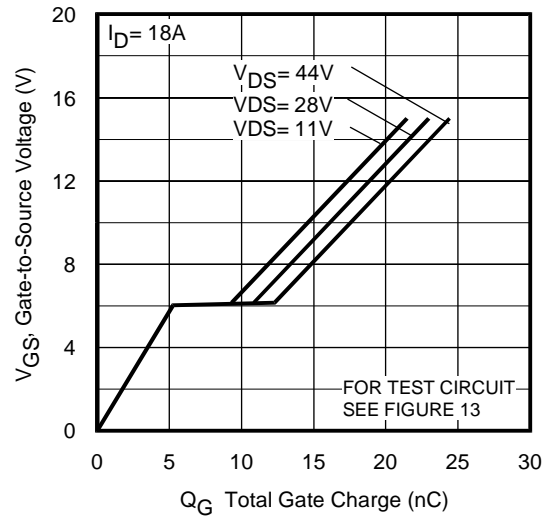

Fig 6. Typical Gate Charge Vs. Gate-to-Source Voltage

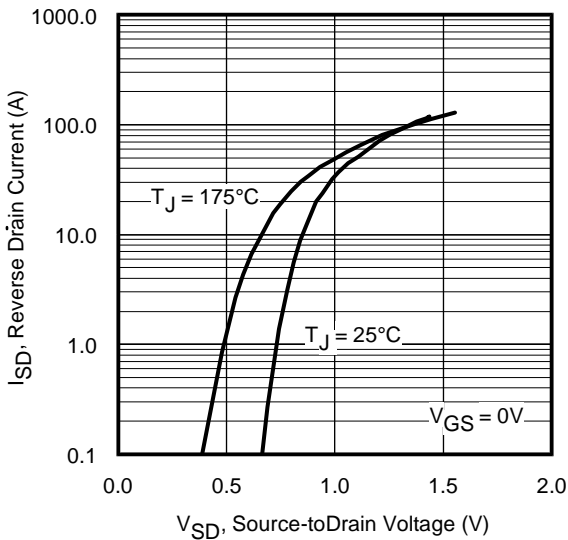

Fig 7. Typical Source-Drain Diode Forward Voltage

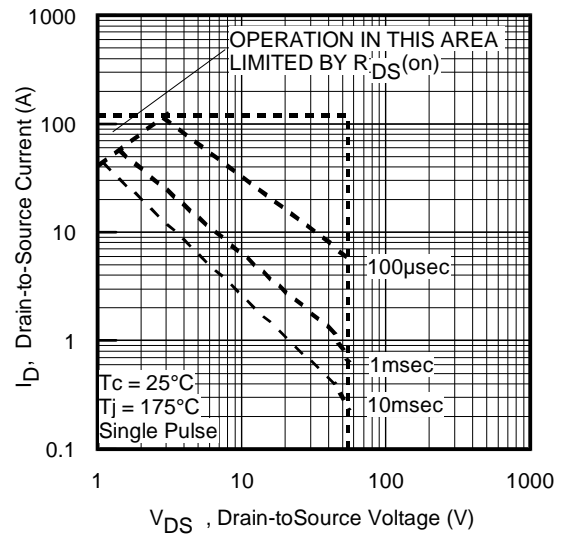

Fig 8. Maximum Safe Operating Area

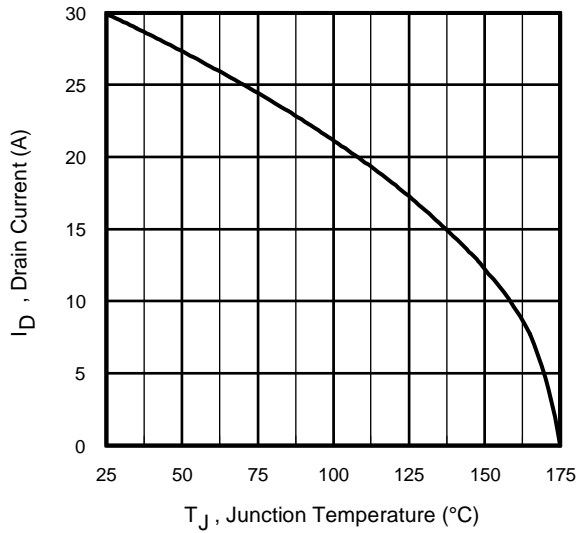

Fig 9. Maximum Drain Current Vs. Case Temperature

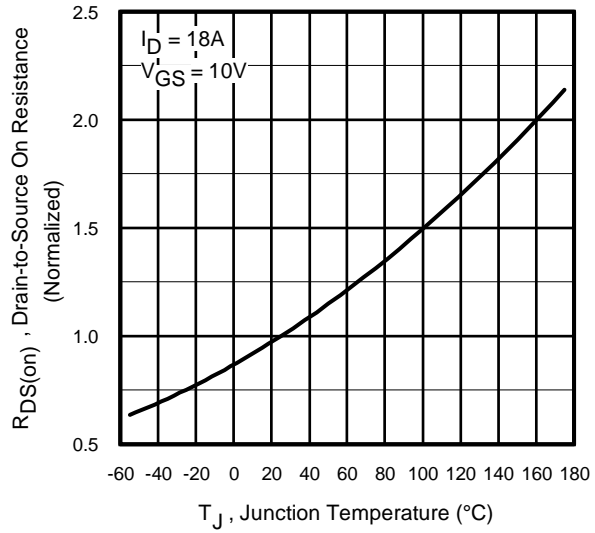

Fig 10. Normalized On-Resistance Vs. Temperature

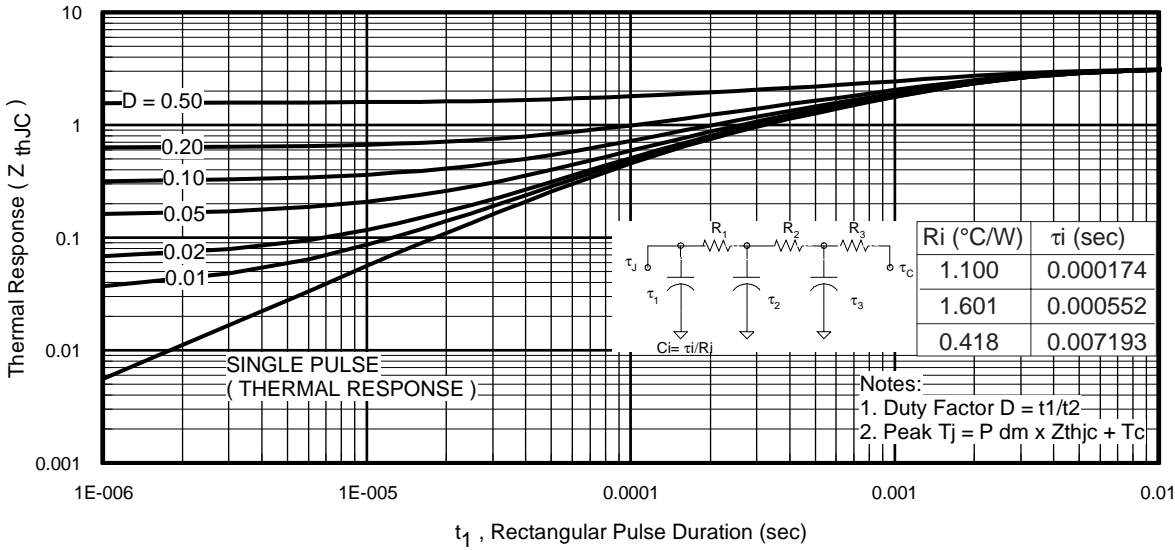

Fig 11. Maximum Effective Transient Thermal Impedance, Junction-to-Case

IRFR/U4105Z

International
IR Rectifier

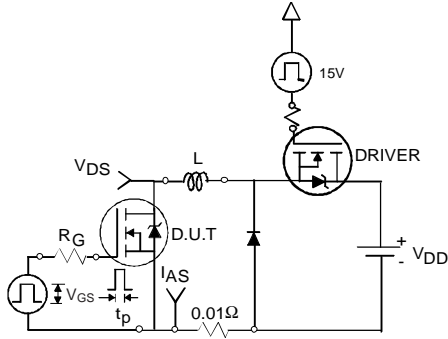

Fig 12a. Unclamped Inductive Test Circuit

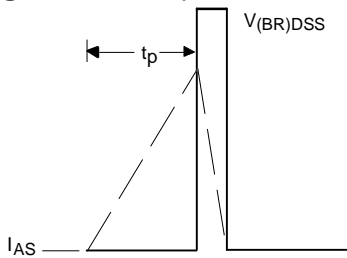

Fig 12b. Unclamped Inductive Waveforms



Fig 13a. Basic Gate Charge Waveform

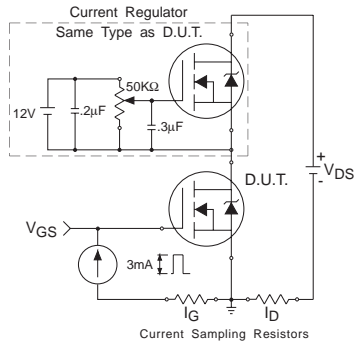

Fig 13b. Gate Charge Test Circuit

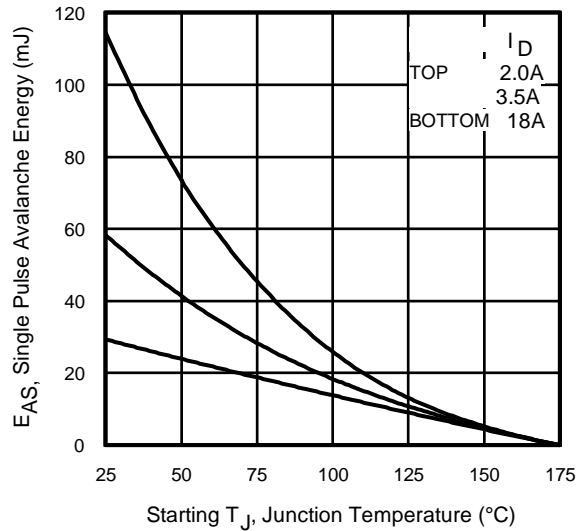

Fig 12c. Maximum Avalanche Energy Vs. Drain Current

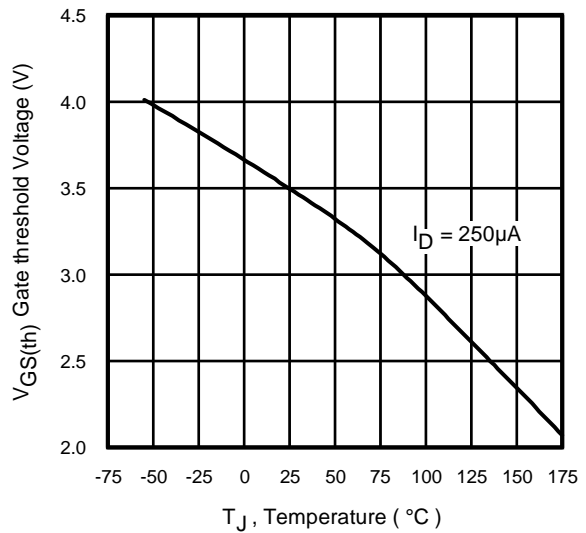

Fig 14. Threshold Voltage Vs. Temperature

www.irf.com

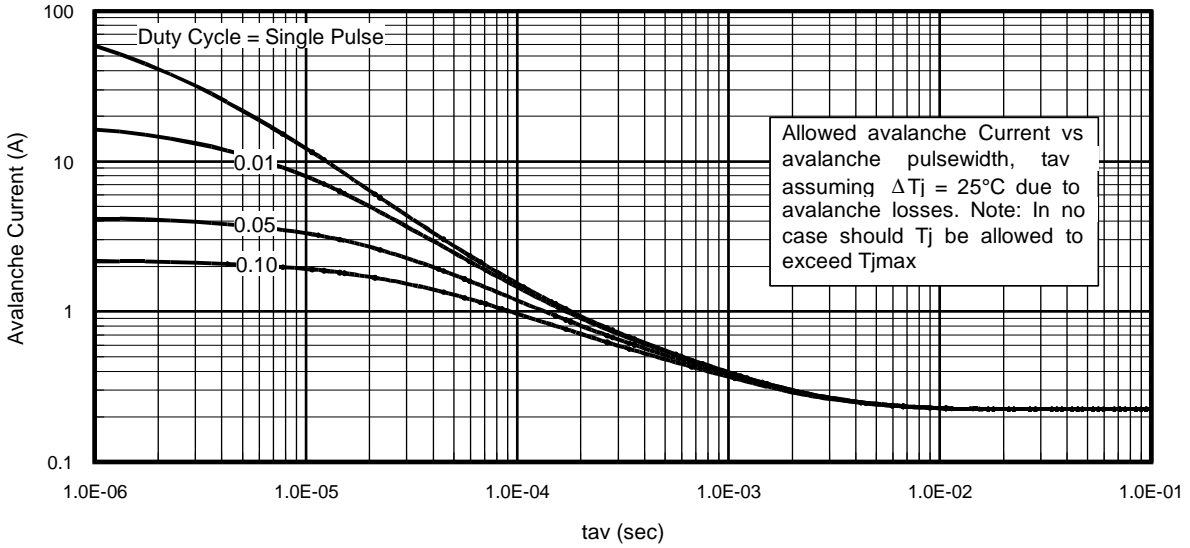

Fig 15. Typical Avalanche Current Vs.Pulsewidth

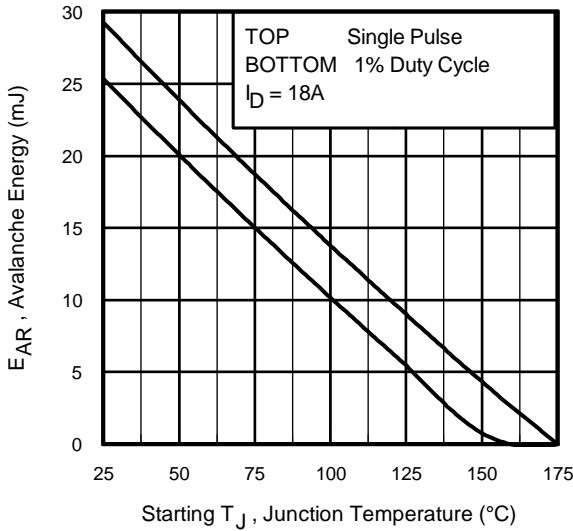

Fig 16. Maximum Avalanche Energy Vs. Temperature

Notes on Repetitive Avalanche Curves , Figures 15, 16:
(For further info, see AN-1005 at www.irf.com)

1. Avalanche failures assumption:
Purely a thermal phenomenon and failure occurs at a temperature far in excess of T_{jmax} . This is validated for every part type.
2. Safe operation in Avalanche is allowed as long as T_{jmax} is not exceeded.
3. Equation below based on circuit and waveforms shown in Figures 12a, 12b.
4. $P_{D(ave)}$ = Average power dissipation per single avalanche pulse.
5. BV = Rated breakdown voltage (1.3 factor accounts for voltage increase during avalanche).
6. I_{av} = Allowable avalanche current.
7. ΔT = Allowable rise in junction temperature, not to exceed T_{jmax} (assumed as 25°C in Figure 15, 16).
 t_{av} = Average time in avalanche.
 D = Duty cycle in avalanche = $t_{av} \cdot f$
 $Z_{thJC}(D, t_{av})$ = Transient thermal resistance, see figure 11)

$$P_{D(ave)} = 1/2 (1.3 \cdot BV \cdot I_{av}) = \Delta T / Z_{thJC}$$

$$I_{av} = 2\Delta T / [1.3 \cdot BV \cdot Z_{th}]$$

$$E_{AS(AR)} = P_{D(ave)} \cdot t_{av}$$

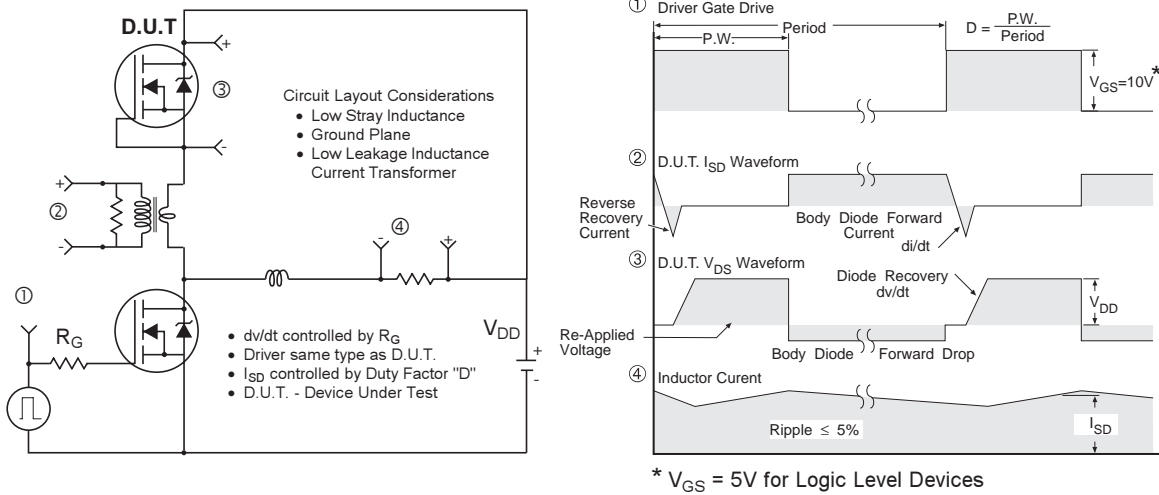

Fig 17. Peak Diode Recovery dv/dt Test Circuit for N-Channel HEXFET® Power MOSFETs

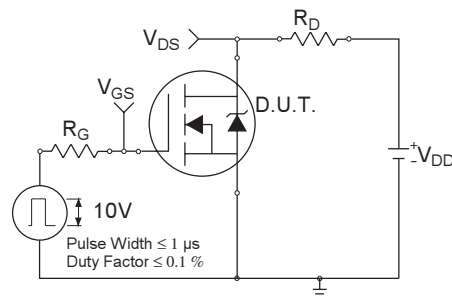

Fig 18a. Switching Time Test Circuit

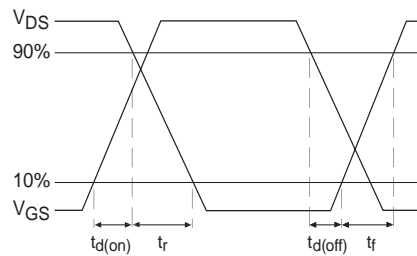
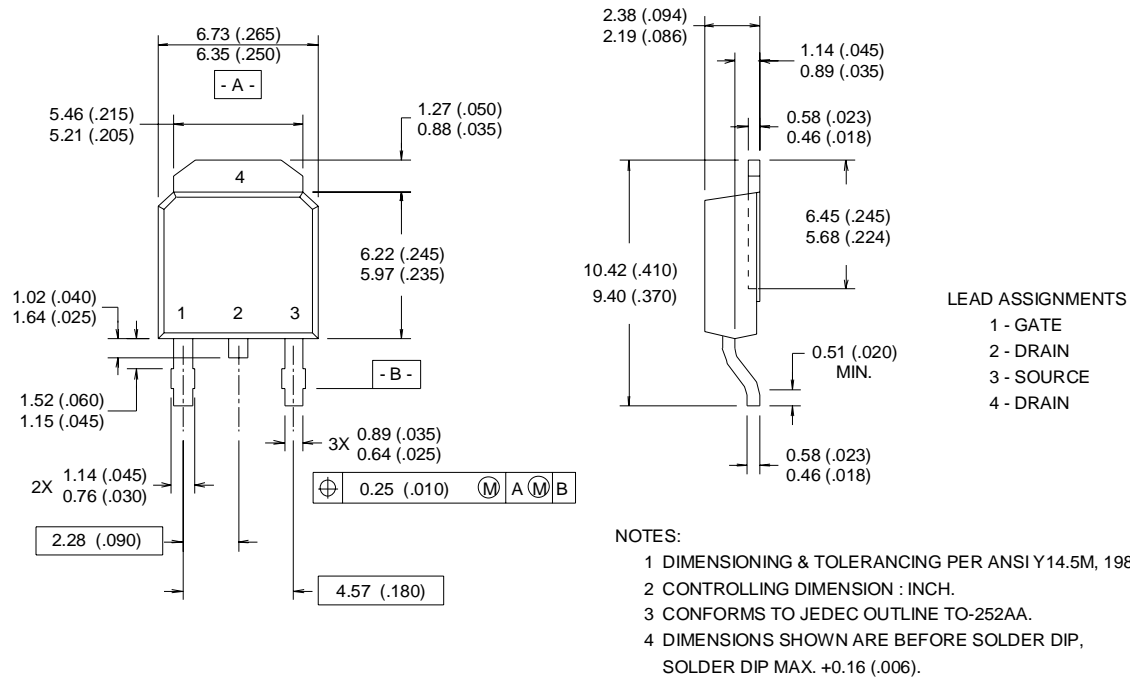

Fig 18b. Switching Time Waveforms

D-Pak (TO-252AA) Package Outline

Dimensions are shown in millimeters (inches)



D-Pak (TO-252AA) Part Marking Information

Notes: This part marking information applies to devices produced before 02/26/2001

EXAMPLE: THIS IS AN IRFR120
WITH ASSEMBLY
LOT CODE 9U1P

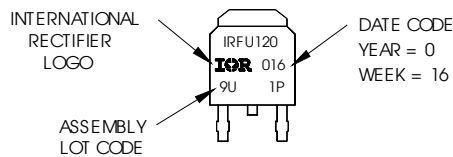

Notes: This part marking information applies to devices produced after 02/26/2001

EXAMPLE: THIS IS AN IRFR120
WITH ASSEMBLY
LOT CODE 1234
ASSEMBLED ON WW 16, 1999
IN THE ASSEMBLY LINE "A"

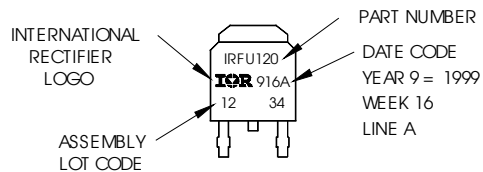

IRFR/U4105Z

International
IR Rectifier

I-Pak (TO-251AA) Package Outline

Dimensions are shown in millimeters (inches)

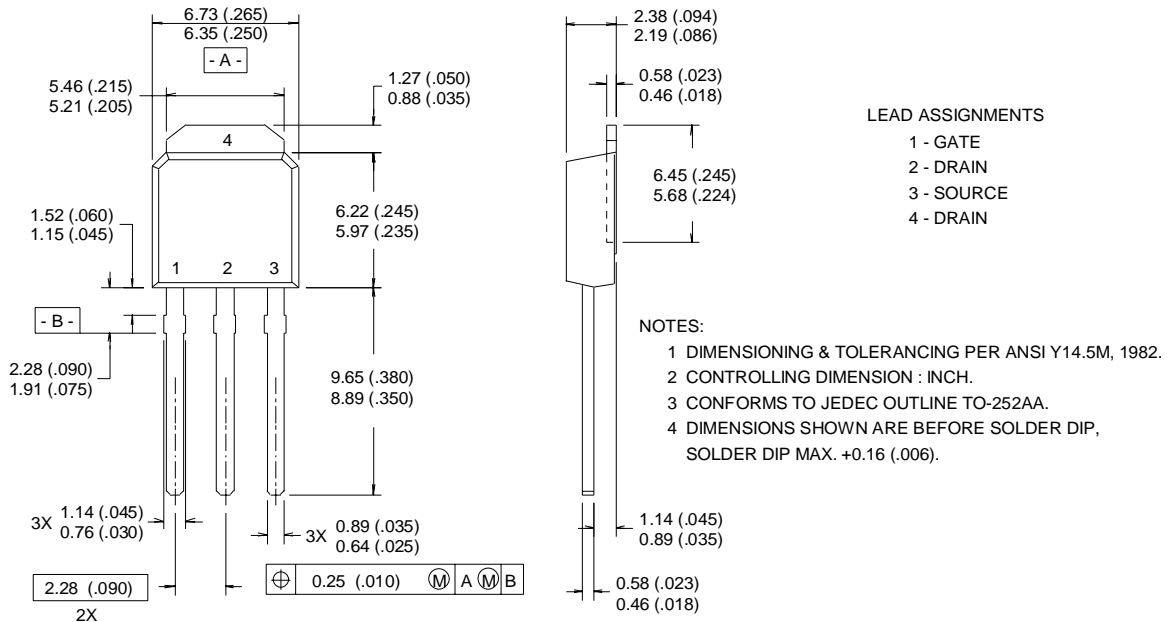

I-Pak (TO-251AA) Part Marking Information

Notes: This part marking information applies to devices produced before 02/26/2001

EXAMPLE: THIS IS AN IRFR120
WITH ASSEMBLY
LOT CODE 9U1P

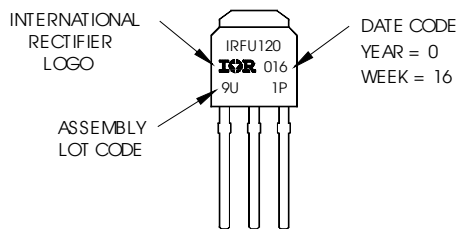

Notes: This part marking information applies to devices produced after 02/26/2001

EXAMPLE: THIS IS AN IRFR120
WITH ASSEMBLY
LOT CODE 5678
ASSEMBLED ON WW 19, 1999
IN THE ASSEMBLY LINE "A"

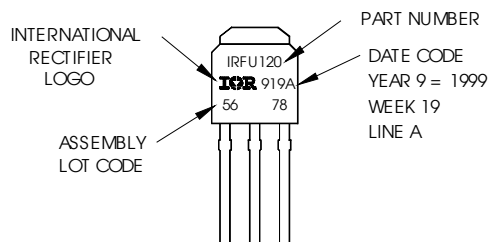

D-Pak (TO-252AA) Tape & Reel Information

Dimensions are shown in millimeters (inches)

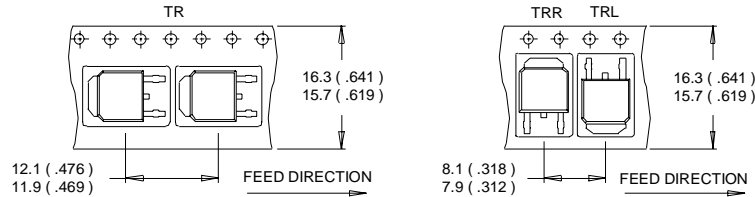

- NOTES :
1. CONTROLLING DIMENSION : MILLIMETER.
 2. ALL DIMENSIONS ARE SHOWN IN MILLIMETERS (INCHES).
 3. OUTLINE CONFORMS TO EIA-481 & EIA-541.

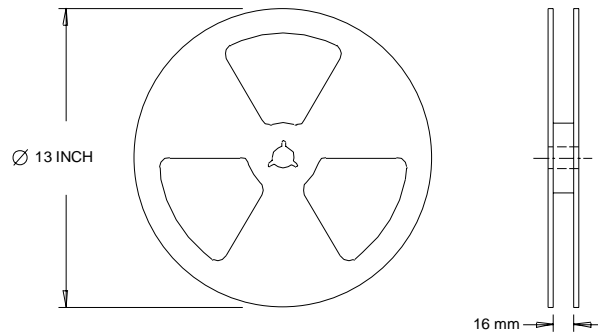

- NOTES :
1. OUTLINE CONFORMS TO EIA-481.

Notes:

- ① Repetitive rating; pulse width limited by max. junction temperature. (See fig. 11).
- ② Limited by T_{Jmax} , starting $T_J = 25^\circ\text{C}$, $L = 0.18\text{mH}$, $R_G = 25\Omega$, $I_{AS} = 18\text{A}$, $V_{GS} = 10\text{V}$. Part not recommended for use above this value.
- ③ Pulse width $\leq 1.0\text{ms}$; duty cycle $\leq 2\%$.
- ④ C_{OSS} eff. is a fixed capacitance that gives the same charging time as C_{OSS} while V_{DS} is rising from 0 to 80% V_{DSS} .
- ⑤ Limited by T_{Jmax} , see Fig.12a, 12b, 15, 16 for typical repetitive avalanche performance.
- ⑥ This value determined from sample failure population. 100% tested to this value in production.
- ⑦ When mounted on 1" square PCB (FR-4 or G-10 Material). For recommended footprint and soldering techniques refer to application note #AN-994

Data and specifications subject to change without notice.
 This product has been designed and qualified for the Automotive [Q101] market.
 Qualification Standards can be found on IR's Web site.

International
IR Rectifier

IR WORLD HEADQUARTERS: 233 Kansas St., El Segundo, California 90245, USA Tel: (310) 252-7105
 TAC Fax: (310) 252-7903

Visit us at www.irf.com for sales contact information.8/03