

Specification

Drawing No.	KB101-12305-431 1/11
Issued Date.	JUN.29, 2012

TO: Digi-Key

Note: In case of specification change, KYOCERA Part Number also will be changed.

Product Name	Quartz Crystal
Product Model	CX3225CA
Frequency	16000kHz
Customer Part Number	-
Customer Specification Number	-
KYOCERA Part Number	CX3225CA16000H0HSSZ1
Remarks	RoHS Compliant, MSL 1, AEC-Q200 compliant

Confirmation of stable oscillation of a crystal oscillation circuit is necessary at the design stage to prevent critical failures for automotive crystal units which are used to control vehicles and secure safety. It is strongly recommended to provide us a test circuit board and let us implement the circuit verification upon your use of our automotive crystal units.

Customer Acceptance



Accept Signature	Approved Date	
	Department	
	Person in charge	

Seller
KYOCERA Corporation
 (Electronic Components Sales Division)
 6 Takeda Tobadono-cho, Fushimi-ku, Kyoto
 612-8501 Japan
 TEL. No. 075-604-3500
 FAX. No. 075-604-3501

Manufacturer
KYOCERA Crystal Device Corporation
 (Marketing & Sales Engineering Division)
 1-8-1, Izumi-hontyo, Komae-shi, Tokyo
 201-8648 Japan
 TEL. No. 03-5497-3111
 FAX. No. 03-5497-3209

Design Department	Quality Assurance	Approved by	Checked by	Issued by
KYOCERA Crystal Device Yamagata Corporation Crystal Units Overseas Design Section Crystal Units Division 1				

Revision History

Rev.No.	Description of revise	Date	Approved by	Checked by	Issued by
1	First Edition	JUN.29,2012			

1. APPLICATION

This specification sheet is applied to quartz crystal "CX3225CA"

2. KYOCERA PART NUMBER

CX3225CA16000H0HSSZ1

3. RATINGS

Items	SYMB.	Rating	Unit	Remarks
Operating Temperature	Topr	-40~+125	°C	
Storage Temperature Range	Tstg	-40~+150	°C	

4. CHARACTERISTICS**4-1 ELECTRICAL CHARACTERISTICS**

Items	Electrical Specification					Test Condition	Remarks
	SYMB.	Min.	Typ.	Max.	Unit		
Mode of Vibration		Fundamental					
Nominal Frequency	F0		16		MHz		
Nominal Temperature	T _{NOM}		25		°C		
Load Capacitance	CL		12.0		pF		
Frequency Tolerance	df/F	-20.0		+20.0	PPM	+25 ±3°C	
Frequency Temperature Characteristics	df/F	-50.0		+50.0		-40~+125°C	
Frequency Aging Rate		-5.0		+5.0		1 year	+25 ±3°C
Equivalent Series Resistance	ESR			100	Ω		
Drive Level	Pd	0.01		200	μW		
Insulation Resistance	IR	500			MΩ	100V(DC)	

5. APPEARANCES, PHYSICAL DIMENSION
OUTLINE DIMENSION (not to scale)

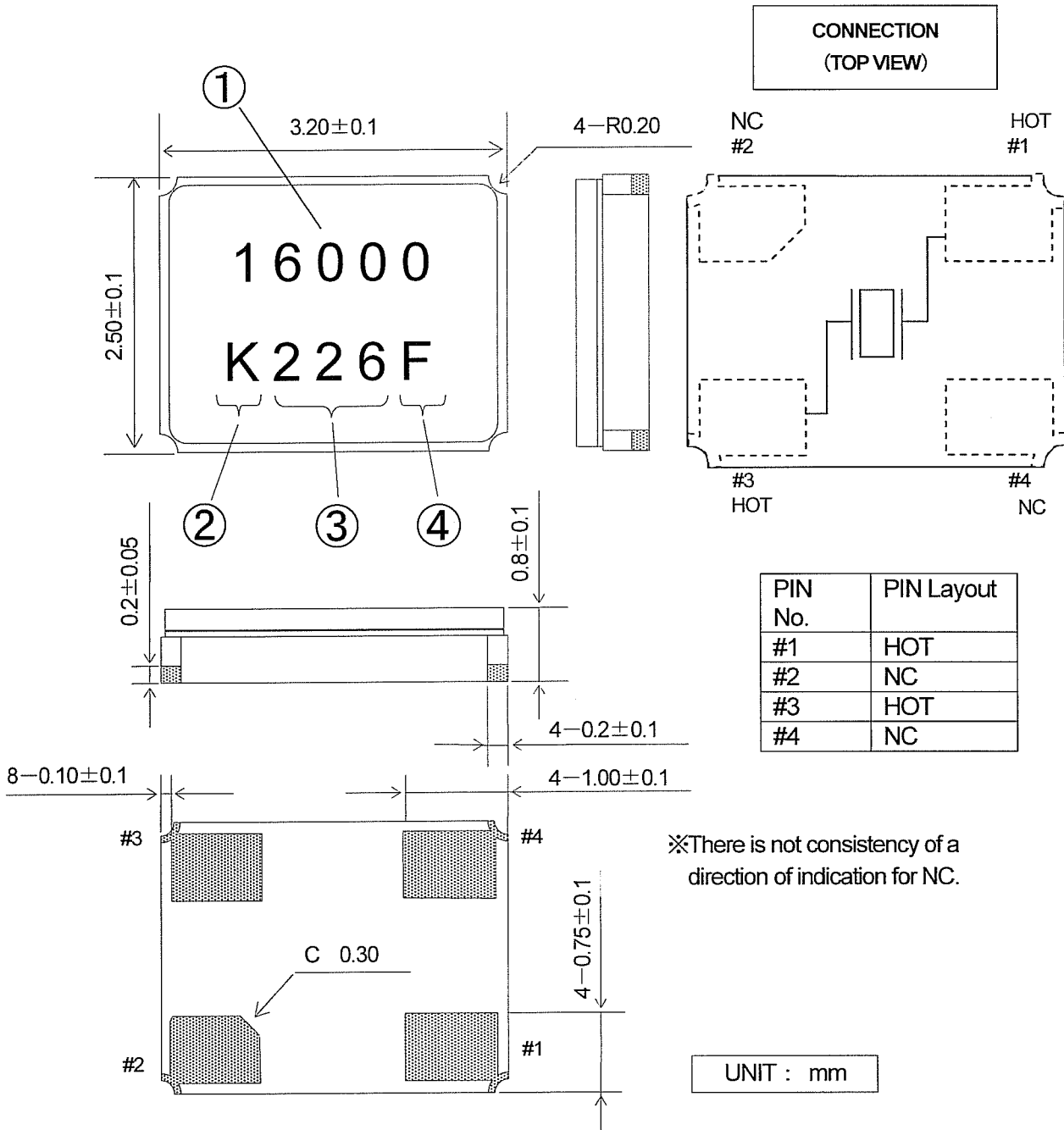

MARKING

① Nominal Frequency

Move the number of maximum indication beams of the frequency to five digits, and omit less than kHz.

② Identification

③ Date Code

Year ··· LAST 1 DIGIT of YEAR AND WEEK

※ For details to LOT CALENDAR

(Ex) JUN.29, 2012 → 226

④ Manufacturing Location F··KYOCERA Crystal Device Philippines, Inc

※The font of marking is reference.

6. RECOMMENDED LAND PATTERN (not to scale)

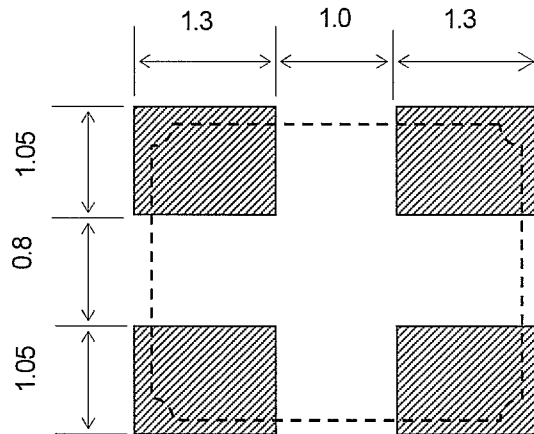

UNIT : mm

7. Quality Assurance

Location

KYOCERA Crystal Device Philippines, Inc. : KYOCERA Crystal Device Philippines, Inc.

Quality Assurance Division

Quality guarantee

When the failure by the responsibility of our company occurs clearly after delivery within 1 year, a substitute article etc. is appropriated gratuitously and this is guaranteed. However, when passing 1 year after delivery, there is a case where I am allowed to consider as onerous repair after both consultation.

8.TAPING & REEL

8-1.Dimensions

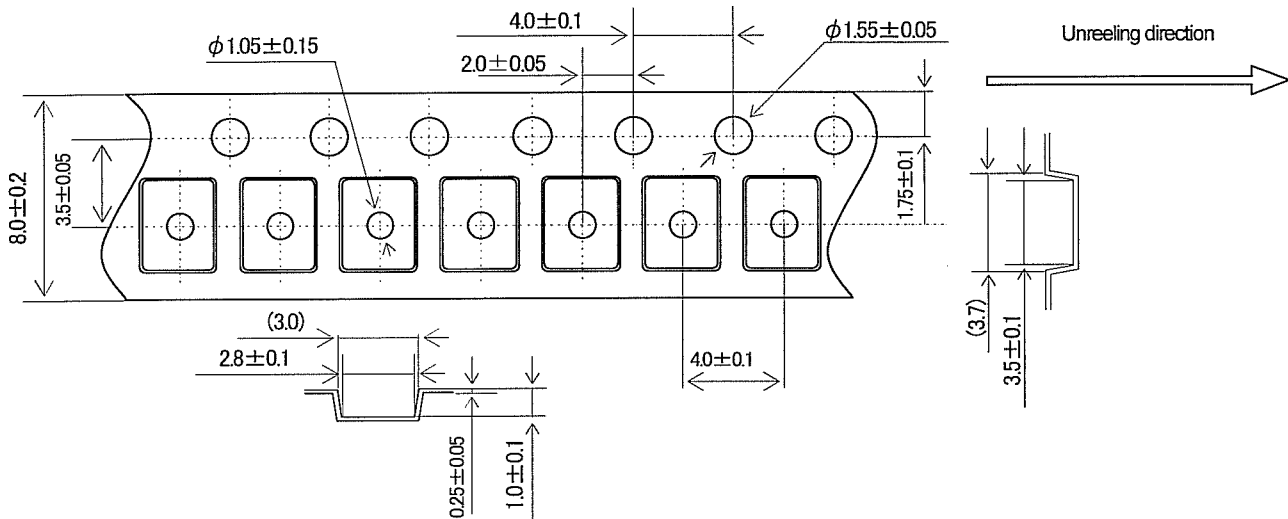

8-2.Leader and trailer tape

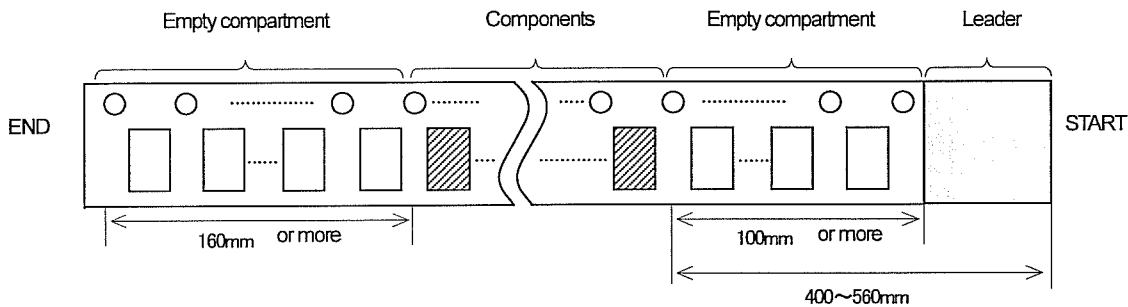

8-3.Direction (The direction shall be seen from the top cover tape side)

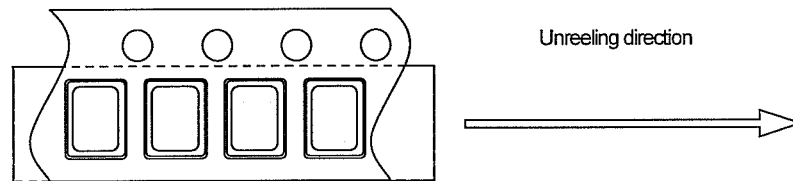

8-4.Specification

1. Material of the carrier tape shall be PS (ESD).
2. Material of the seal tape shall be polyester(ESD).
3. The seal tape shall not cover the sprocket holes. And not protrude from the carrier tape.
4. Tensile strength of the tape : 10N or more.
5. The R of the corner without designation is 0.2RMAX.
6. Disalignment between centers of the cavity and sprocket hole shall be 0.05mm or less.
7. Cumulative pitch tolerance of "P₀" shall be $\pm 0.2\text{mm}$ at 10 pitches.
8. The number of lack is 0.1% of 1 reel total part number (the number of the table letters) or the part following whose 1 either is big.
(But, the thing which lack of the continuance is not in.)
9. The marking on parts is not fixed its direction, its electrical characteristic is equal.
10. Peeling force of the seal tape: 0.1 to 1.0N.

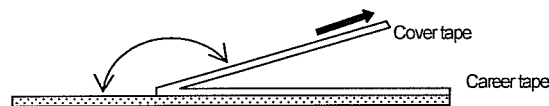

8-5.Reel specifications

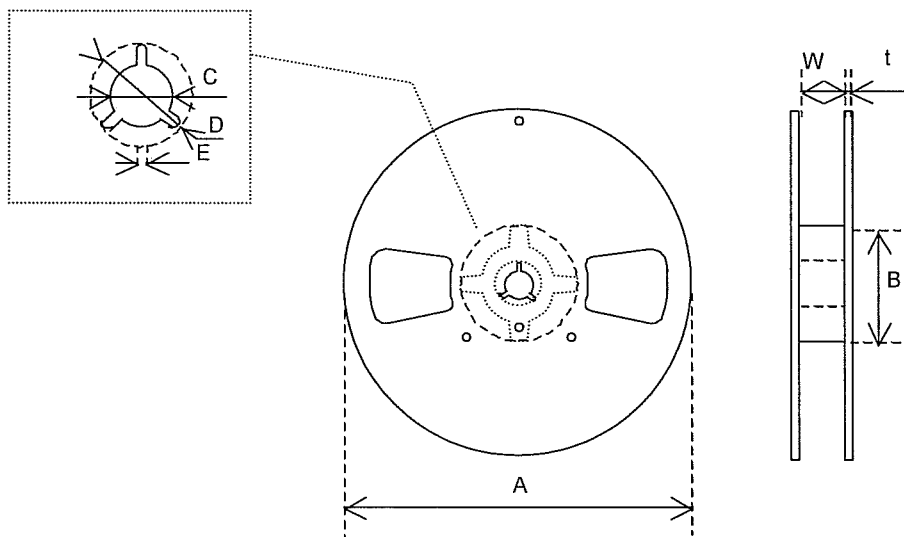

(Nonconductor type Reel)

In the case of $\Phi 180$ Reel (3000 pcs max)

	A	B	C	D
Dimension	$\phi 180 +0/-1.5$	$\phi 60 +1/-0$	$\phi 13 \pm 0.2$	$\phi 21 \pm 0.8$
Symbol	E	W	t	
Dimension	2.0 ± 0.5	9 ± 1	2.0 ± 0.5	

(Unit : mm)

9.Environmental requirements

After following test, frequency shall not change more than $\pm 10 \times 10^{-6}$

And CI, $\pm 20\%$ or 5Ω of large value.

9.1 Resistance to Shock Test condition
Natural dropped from height 100cm onto hard wood board in 3 times

9.2 Resistance to Vibration Test condition
frequency : 10—55 —10 Hz
Amplitude : 1.5mm
Cycle time : 15 minutes
Direction : X,Y,Z (3direction),2 h each.

9.3 Resistance to Heat Test condition
The quartz crystal unit shall be stored at a temperature of $+150 \pm 2^\circ\text{C}$ for 500 h.
Then it shall be subjected to standard atmospheric conditions for 1 h ,after which measurement shall be made.

9.4 Resistance to Cold Test condition
The quartz crystal unit shall be stored at a temperature of $-40 \pm 2^\circ\text{C}$ for 500 h.
Then it shall be subjected to standard atmospheric conditions for 1 h ,after which measurement shall be made.

9.5 Thermal Shock Test condition
The quartz crystal unit shall be subjected to 500 successive change of temperature cycles , each as shown in table below, Then it shall be subjected to standard atmospheric conditions for 1h, after which measurements shall be made.
Cycle : $-40 \pm 2^\circ\text{C}$ (30min.) $\sim 25 \pm 2^\circ\text{C}$ (5min.)
 $\sim +150 \pm 2^\circ\text{C}$ (30min.) $\sim 25 \pm 2^\circ\text{C}$ (5min.)

9.6 Resistance to Moisture

Test condition

The quartz crystal unit shall be stored at a temperature of $60 \pm 2^\circ\text{C}$ with relative humidity of 90% to 95% for 240 h. Then it shall be subjected to standard atmospheric conditions for 1h, after which measurements shall be made

9.7 Soldering condition

1) Material of solder

Kind ... lead free solder paste

Melting point ... $220 \pm 5^\circ\text{C}$

2) Temp.profile of reflow soldering system

	Temp [$^\circ\text{C}$]	Time[sec]
Peak	260 ± 5	10 (max.)
Preheating	180 (typ.)	100 (typ.)
Total	—	200 (max.)

Temp. profile of reflow

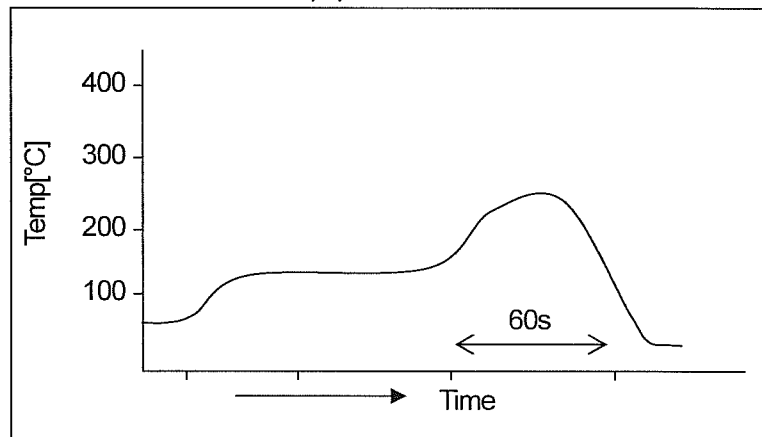
3) Hand Soldering Temperature: 350°C , Time: 3sec

9.8 Intensity for bending in circuit board

Solder this product in center of the circuit board of $40\text{mm} \times 100\text{mm}$, and add the deflection of 3mm as the bottom figure.

Test board : $t=1.6\text{mm}$

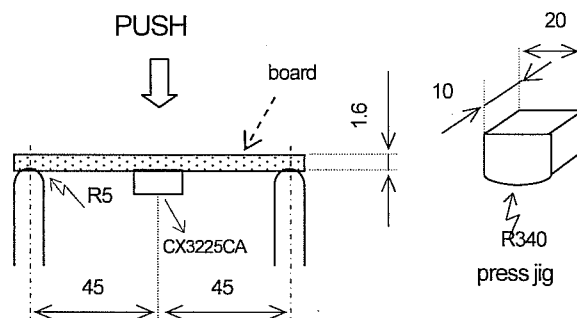

UNIT : mm

10. Cautions for use

(1) Automatic mounting machine use

Please use after affirmation that select the mounting machine model with a shock small if possible in the case of use of an automatic mounting machine, and it does not have breakage. There is a risk of a quartz crystal unit breakage occurring and not functioning normally by too much shock etc..

(2) Conformity of a circuit

In case of use of an oscillation circuit, please insert in a quartz crystal unit in series resistance 5 time as many as the standard value of equivalent in-series resistance, and confirm oscillating. Please remove resistance which inserted after the notes above-mentioned examination in the quartz crystal unit in series, and use it.

(3) After making the Quartz Crystal mount on a printed circuit board ,if it is required to devide the printed circuit board into another one, use it with attentive confirmation so that a warp caused by this dividing might not affect any damage. When designing a printed circuit board as well as handling the mounting As much as possible. The quartz crystal shall be passed through the reflow furnace. Then it shall be subjected to standard atmospheric conditions, after which cleaning shall be made.

11. Storage conditions

Storage at prolonged high temperature or low temperature and the storage by high humidity cause degradation of frequency accuracy, and degradation of soldering nature. Storage is performed at the temperature of 18-30 degrees C, and the humidity of 20-70 Percent in the state of packing, and a term is 6 months.

12. Others

When any questions and opinions are in the written matter of these delivery specifications, I will ask connection of you from the our company issue day within 45 days. In a connection no case, a written matter is consented to it and employed within a term.

13.LOT CALENDAR

WEEK	MONTH	MON	TUE	WED	THU	FRI	SAT	SUN	WEEK	MONTH	MON	TUE	WED	THU	FRI	SAT	SUN
週	月	月	火	水	木	金	土	日	週	月	月	火	水	木	金	土	日
152	1							1	227	7	2	3	4	5	6	7	8
201		2	3	4	5	6	7	8	228		9	10	11	12	13	14	15
202		9	10	11	12	13	14	15	229		16	17	18	19	20	21	22
203		16	17	18	19	20	21	22	230		23	24	25	26	27	28	29
204		23	24	25	26	27	28	29	231	8	30	31	1	2	3	4	5
205	2	30	31	1	2	3	4	5	232		6	7	8	9	10	11	12
206		6	7	8	9	10	11	12	233		13	14	15	16	17	18	19
207		13	14	15	16	17	18	19	234		20	21	22	23	24	25	26
208		20	21	22	23	24	25	26	235	9	27	28	29	30	31	1	2
209	3	27	28	29	1	2	3	4	236		3	4	5	6	7	8	9
210		5	6	7	8	9	10	11	237		10	11	12	13	14	15	16
211		12	13	14	15	16	17	18	238		17	18	19	20	21	22	23
212		19	20	21	22	23	24	25	239		24	25	26	27	28	29	30
213	4	26	27	28	29	30	31	1	240	10	1	2	3	4	5	6	7
214		2	3	4	5	6	7	8	241		8	9	10	11	12	13	14
215		9	10	11	12	13	14	15	242		15	16	17	18	19	20	21
216		16	17	18	19	20	21	22	243		22	23	24	25	26	27	28
217		23	24	25	26	27	28	29	244	11	29	30	31	1	2	3	4
218	5	30	1	2	3	4	5	6	245		5	6	7	8	9	10	11
219		7	8	9	10	11	12	13	246		12	13	14	15	16	17	18
220		14	15	16	17	18	19	20	247		19	20	21	22	23	24	25
221		21	22	23	24	25	26	27	248	12	26	27	28	29	30	1	2
222	6	28	29	30	31	1	2	3	249		3	4	5	6	7	8	9
223		4	5	6	7	8	9	10	250		10	11	12	13	14	15	16
224		11	12	13	14	15	16	17	251		17	18	19	20	21	22	23
225		18	19	20	21	22	23	24	252		24	25	26	27	28	29	30
226	7	25	26	27	28	29	30	1	253		31						