

2.65W PWM Class-D Power Amplifier

General Description

The RT9101 is a 2.65W, high efficiency Class-D audio amplifier featuring low-resistance internal power MOSFETs and the gain can be set by an external input resistance. The filter free topology eliminates the output filter and reduces the external component count, footprint area, and system costs.

Operating from a single 5V supply, the RT9101 is capable of driving 4Ω speaker load at a continuous average output of 2.65W/10% THD+N or 2W/0.5% THD+N. The RT9101 has a higher efficiency with speaker load compared to a typical class AB amplifier. With a 3.6V supply driving an 8Ω speaker, the efficiency for a 400mW power level is 88%.

It is very suitable for power sensitive application, such as cellular handsets and battery powered devices. In addition to these features, the RT9101 provides a fast startup time to minimize audible popping during device turn-on and turn-off. Moreover, the RT9101 also integrates thermal and over current protection circuits.

The RT9101 is available in WDFN-8L 3x3, and WL-CSP-9B 1.45x1.45 (BSC) packages.

Ordering Information

RT9101□(□)□	
□	Package Type QW : WDFN-8L 3x3 (W-Type) WSC : WL-CSP-9B 1.45x1.45 (BSC)
□	Lead Plating System G : Green (Halogen Free and Pb Free) Z : ECO (Ecological Element with Halogen Free and Pb free)
□	Default : WDFN-8L 3x3 C : WL-CSP-9B 1.45x1.45 (BSC)

Note :

Richtek products are :

- ▶ RoHS compliant and compatible with the current requirements of IPC/JEDEC J-STD-020.
- ▶ Suitable for use in SnPb or Pb-free soldering processes.

Features

- **Wide Operating Voltage : 2.5V to 5.5V**
- **High Efficiency With an 8Ω Speaker :**
 - ▶ **88% at 400mW**
 - ▶ **80% at 100mW**
- **Low Quiescent Current and Shutdown Current**
- **Optimized PWM Output Stage Eliminates LC Filter**
- **Fully Differential Design Reduces RF Rectification and Eliminates Bypass Capacitor**
- **Internally Generated 250kHz Switching Frequency**
- **Integrated Pop and Click Suppression Circuitry**
- **RoHS Compliant and Halogen Free**

Applications

- Mobile Phones
- Handsets
- PDAs
- Portable multimedia devices

Pin Configurations

(TOP VIEW)

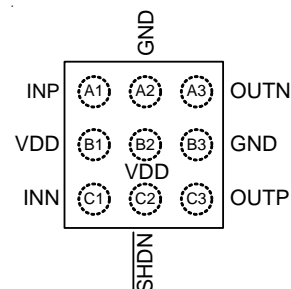
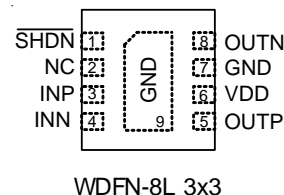

Marking Information

RT9101GQW

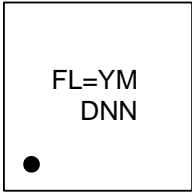

FL : Product Code
YMDNN : Date Code

RT9101CWSC

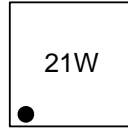

21 : Product Code
W : Date Code

RT9101ZQW

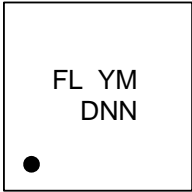

FL : Product Code
YMDNN : Date Code

Typical Application Circuit

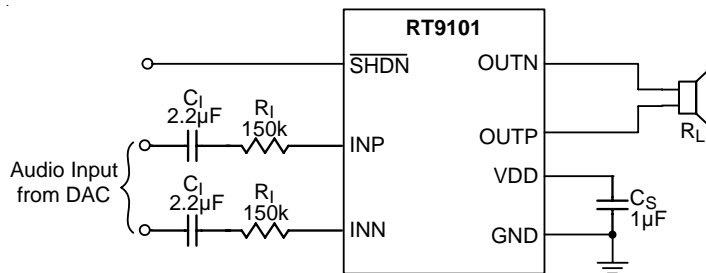

Figure 1. Application Circuit with Differential Input

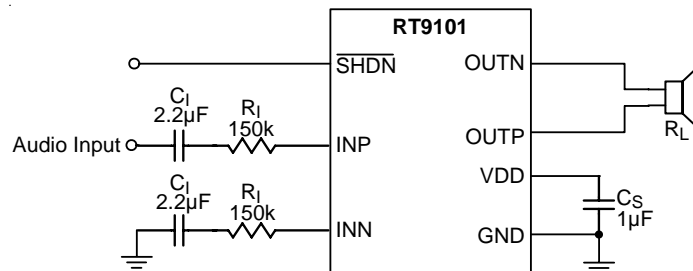
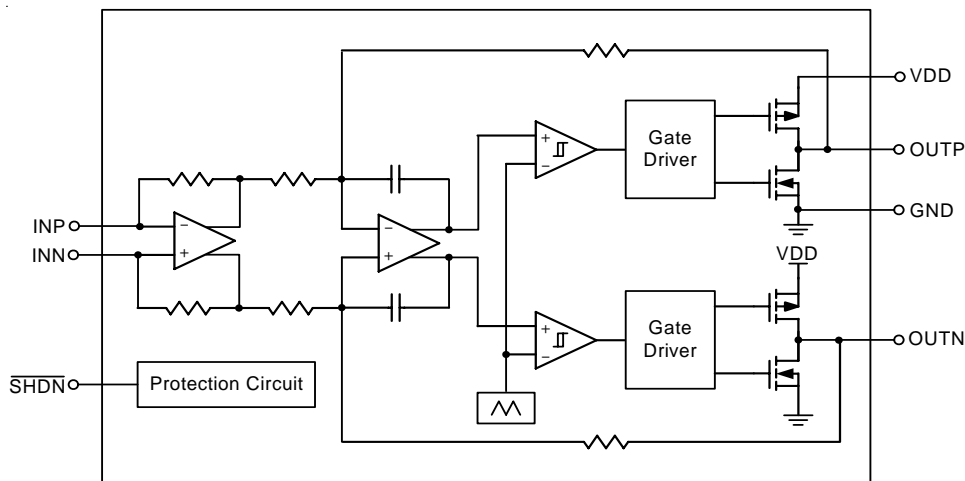

Figure 2. Application Circuit with Single-Ended Input

Functional Pin Description

Pin No.		Pin Name	Pin Function
WDFN-8L 3x3	WL-CSP-9B 1.45x1.45 (BSC)		
1	C2	SHDN	Shutdown Control (Active Low).
2	--	NC	No Internal Connection.
3	A1	INP	Positive Input of Differential Audio Signal.
4	C1	INN	Negative Input of Differential Audio Signal.
5	C3	OUTP	Positive Output.
6	B1, B2	VDD	Supply Voltage Input.
7, 9 (Exposed Pad)	A2, B3	GND	Ground. The exposed pad must be soldered to a large PCB and connected to GND for maximum thermal dissipation.
8	A3	OUTN	Negative Output.

Function Block Diagram



Absolute Maximum Ratings (Note 1)

- Supply Voltage, V_{DD} ----- -0.3V to 6V
- Input Voltage, INP, INN ----- -0.3V to ($V_{DD} + 0.3V$)
- Power Dissipation, P_D @ $T_A = 25^\circ C$
 - WDFN-8L 3x3 ----- 1.429W
 - WL-CSP-9B 1.45x1.45 (BSC) ----- 1.250W
- Package Thermal Resistance (Note 2)
 - WDFN-8L 3x3, θ_{JA} ----- $70^\circ C/W$
 - WDFN-8L 3x3, θ_{JC} ----- $8.2^\circ C/W$
 - WL-CSP-9B 1.45x1.45 (BSC), θ_{JA} ----- $80^\circ C/W$
- Junction Temperature ----- $150^\circ C$
- Lead Temperature (Soldering, 10 sec.) ----- $260^\circ C$
- Storage Temperature Range ----- $-65^\circ C$ to $150^\circ C$
- ESD Susceptibility (Note 3)
 - HBM (Human Body Mode) ----- 2kV
 - MM (Machine Mode) ----- 200V

Recommended Operating Conditions (Note 4)

- Supply Voltage, V_{DD} ----- 2.7V to 5.5V
- Junction Temperature Range ----- $-40^\circ C$ to $125^\circ C$
- Ambient Temperature Range ----- $-40^\circ C$ to $85^\circ C$

Electrical Characteristics

($V_{DD} = 5V$, $T_A = 25^\circ C$, unless otherwise specified)

Parameter	Symbol	Test Conditions	Min	Typ	Max	Unit
Output Offset Voltage	V_{OS}	$V_{DD} = 2.5V$ to $5.5V$	--	1	25	mV
Power Supply Rejection Ratio	PSRR	$V_{DD} = 2.5V$ to $5.5V$ (Note 5)	--	-70	-55	dB
High Level Input Current	$ I_{IH} $	$V_{DD} = 5.5V$, $V_I = 5.8V$	--	--	100	μA
Low Level Input Current	$ I_{IL} $	$V_{DD} = 5.5V$, $V_I = -0.3V$	--	--	5	μA
SHDN Input Threshold Voltage	Logic-High	V_{IH}	2	--	--	V
	Logic-Low	V_{IL}	--	--	0.4	
Quiescent Current	I_Q	$V_{DD} = 5.5V$, No Load	--	3.4	4.9	mA
		$V_{DD} = 3.6V$, No Load	--	2.8	--	
		$V_{DD} = 2.5V$, No Load	--	2.2	3.2	
Shutdown Current	I_{SHDN}	$V_{SHDN} = 0V$, $V_{DD} = 2.5V$ to $5.5V$	--	--	1	μA
Static Drain-Source On-State Resistance	$R_{DS(ON)}$	$V_{DD} = 2.5V$	--	600	--	m Ω
		$V_{DD} = 3.6V$	--	500	--	
		$V_{DD} = 5V$	--	400	--	
Output Impedance in \overline{SHDN}		$V_{SHDN} = 0V$	--	>1	--	k Ω
Switching Frequency		$V_{DD} = 2.5V$ to $5.5V$	200	250	300	kHz
Gain		$V_{DD} = 2.5V$ to $5.5V$	$284k/R_I$	$300k/R_I$	$316k/R_I$	V/V
Resistance from \overline{SHDN} to GND			--	200	--	k Ω

To be continued

Operating Characteristics

(Gain = 2V/V, $R_L = 8\Omega$, $T_A = 25^\circ\text{C}$, unless otherwise noted)

Parameter	Symbol	Test Condition	Min	Typ	Max	Unit	
Output Power	P_O	THD+N = 10%, f = 1kHz, $R_L = 4\Omega$	$V_{DD} = 5V$	--	2.65	--	W
			$V_{DD} = 3.6V$	--	1.5	--	
			$V_{DD} = 2.5V$	--	0.52	--	
		THD+N = 1%, f = 1kHz, $R_L = 4\Omega$	$V_{DD} = 5V$	--	2.08	--	W
			$V_{DD} = 3.6V$	--	1.06	--	
			$V_{DD} = 2.5V$	--	0.42	--	
		THD+N = 10%, f = 1kHz, $R_L = 8\Omega$	$V_{DD} = 5V$	--	1.45	--	W
			$V_{DD} = 3.6V$	--	0.73	--	
			$V_{DD} = 2.5V$	--	0.33	--	
		THD+N = 1%, f = 1kHz, $R_L = 8\Omega$	$V_{DD} = 5V$	--	1.19	--	W
			$V_{DD} = 3.6V$	--	0.59	--	
			$V_{DD} = 2.5V$	--	0.26	--	
Total Harmonic Distortion Plus Noise	THD+N	$V_{DD} = 5V, P_O = 1W, R_L = 8\Omega, f = 1kHz$	--	0.06	--	%	
		$V_{DD} = 3.6V, P_O = 0.5W, R_L = 8\Omega, f = 1kHz$	--	0.05	--		
		$V_{DD} = 2.5V, P_O = 200mW, R_L = 8\Omega, f = 1kHz$	--	0.04	--		
Supply Ripple Rejection Ratio	PSRR	$V_{DD} = 5V, f = 217Hz, V_{DD-Ripple} = 200mV_{pp}$	--	-70	--	dB	
Signal-to-Noise Ratio	SNR	$V_{DD} = 5V, P_O = 1W, R_L = 8\Omega, A$ Weighting Filter	--	95	--	dB	
Input Impedance	Z_i		142	150	158	$k\Omega$	
Start-Up Time from Shutdown		$V_{DD} = 3.6V$	--	1	--	ms	

Note 1. Stresses listed as the above "Absolute Maximum Ratings" may cause permanent damage to the device. These are for stress ratings. Functional operation of the device at these or any other conditions beyond those indicated in the operational sections of the specifications is not implied. Exposure to absolute maximum rating conditions for extended periods may remain possibility to affect device reliability.

Note 2. θ_{JA} is measured in natural convection at $T_A = 25^\circ\text{C}$ on a high-effective thermal conductivity four-layer test board of JEDEC 51-7 thermal measurement standard. The measurement case position of θ_{JC} is on the exposed pad of the package.

Note 3. Devices are ESD sensitive. Handling precaution is recommended.

Note 4. The device is not guaranteed to function outside its operating conditions.

Note 5. Guarantee by design.

Typical Operating Characteristics

Efficiency vs. Output Power

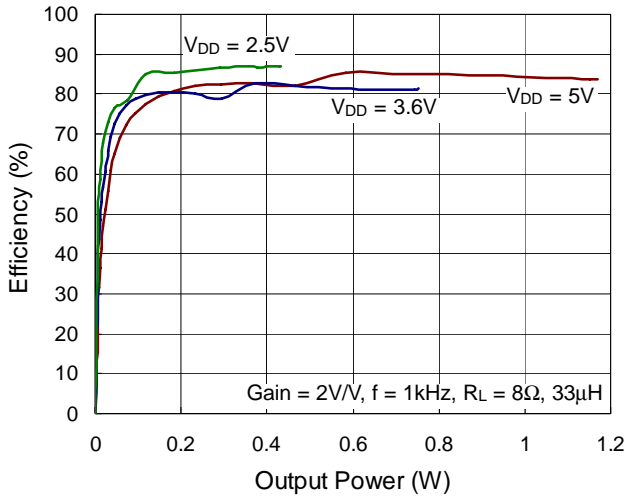

Efficiency vs. Output Power

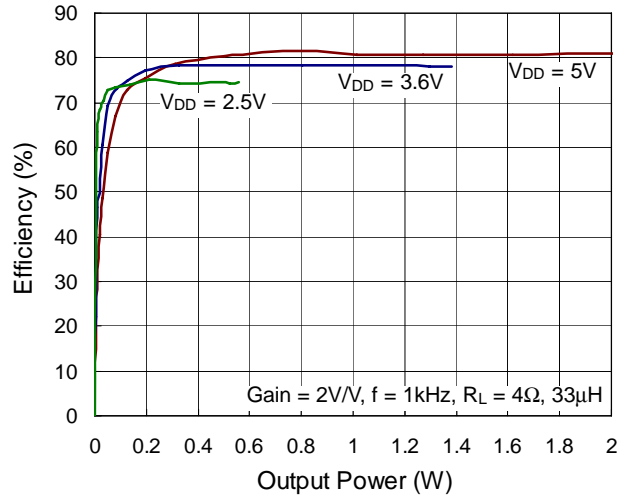

Output Power vs. Load Resistance

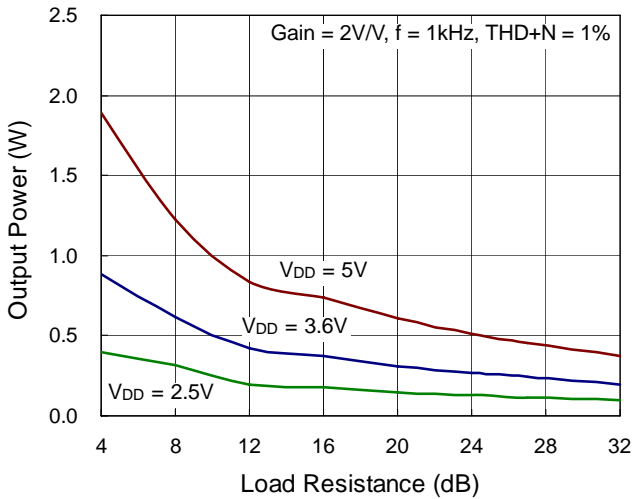

Output Power vs. Load Resistance

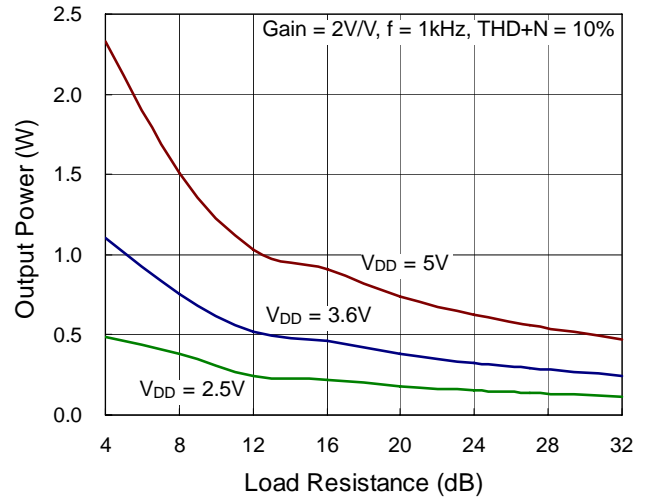

Supply Current vs. Output Power

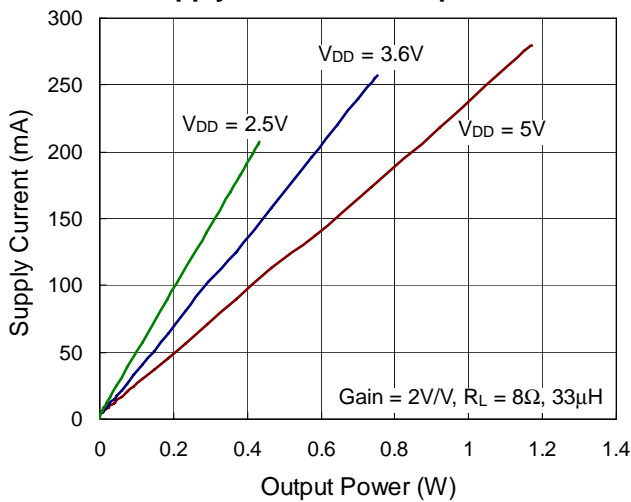

Supply Current vs. Output Power

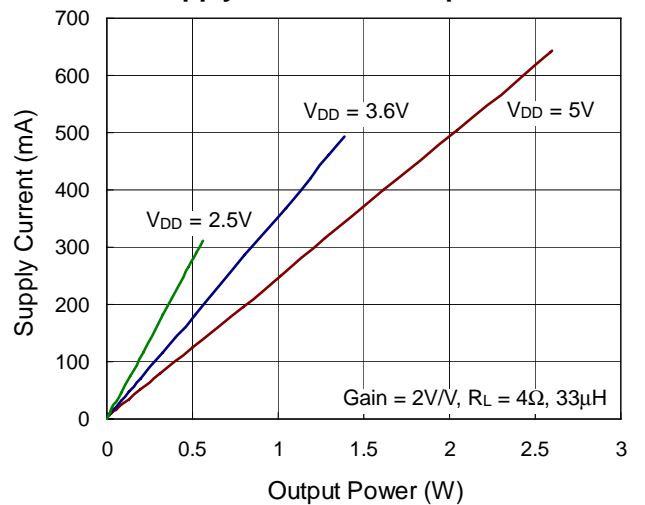

THD+N vs. Output Power

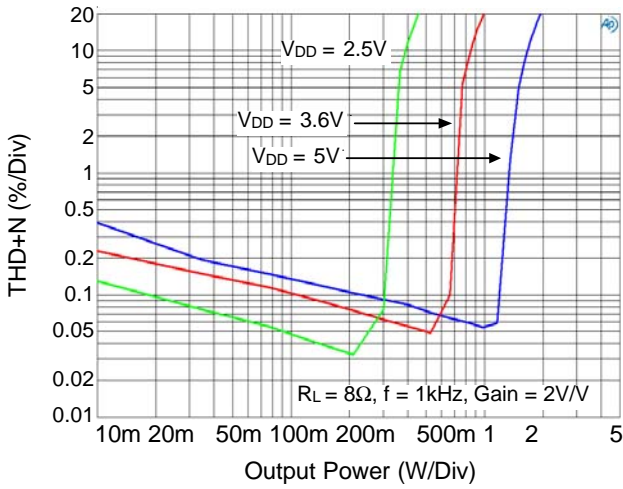

THD+N vs. Output Power

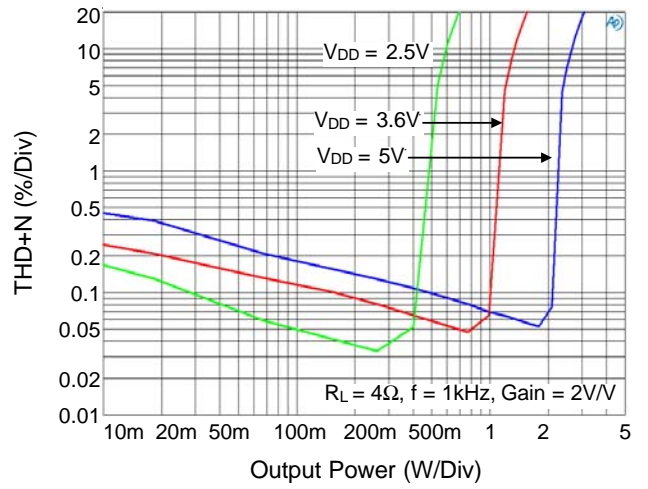

THD+N vs. Frequency

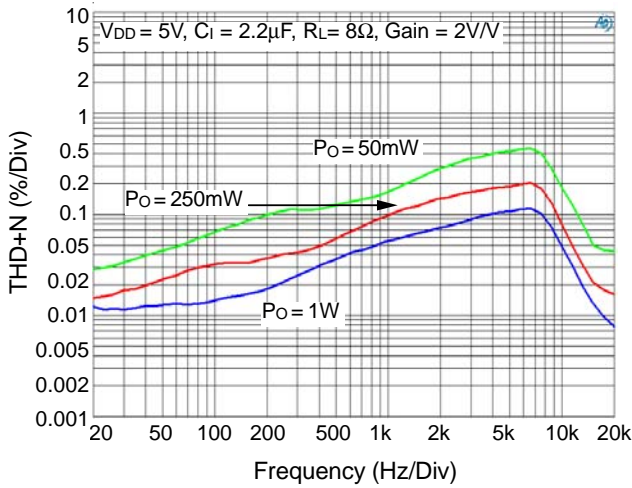

THD+N vs. Frequency

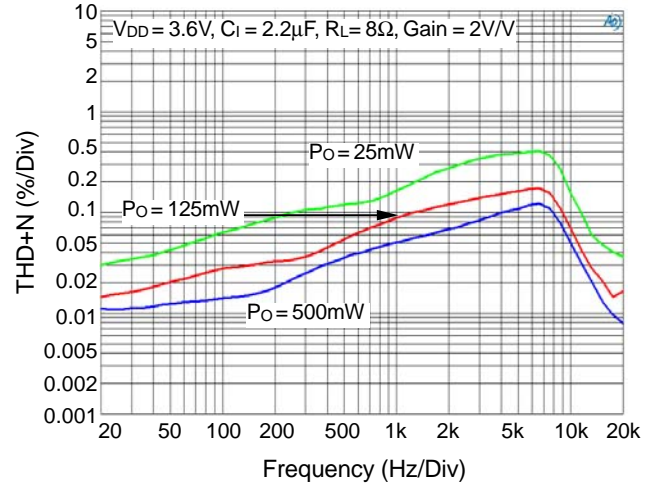

THD+N vs. Frequency

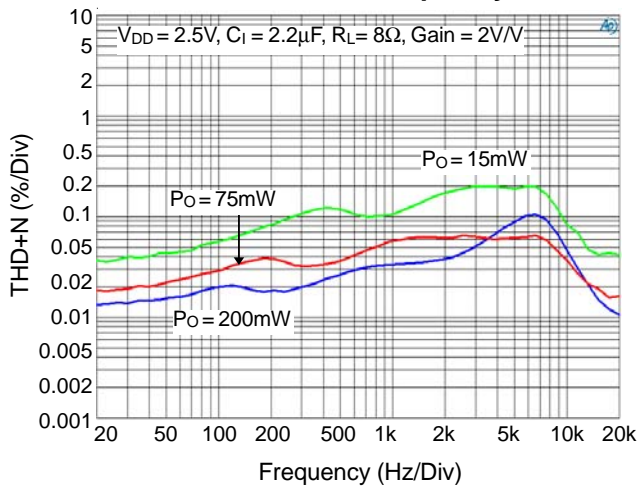

THD+N vs. Frequency

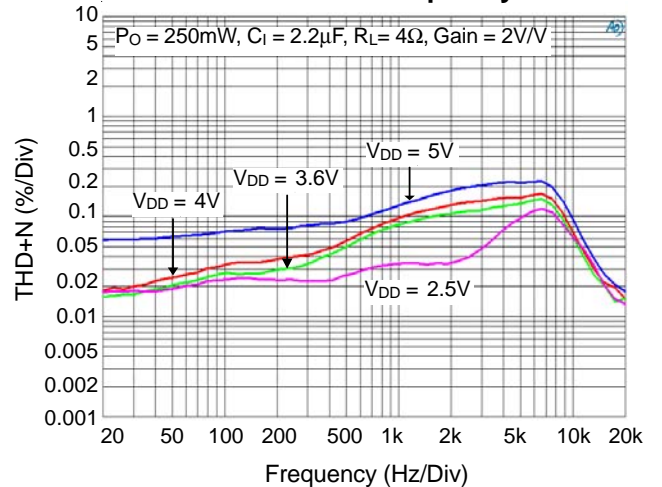

PSRR vs. Frequency

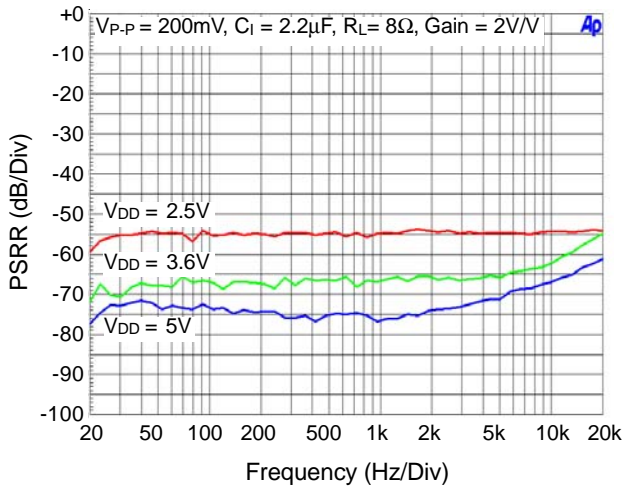

PSRR vs. Frequency

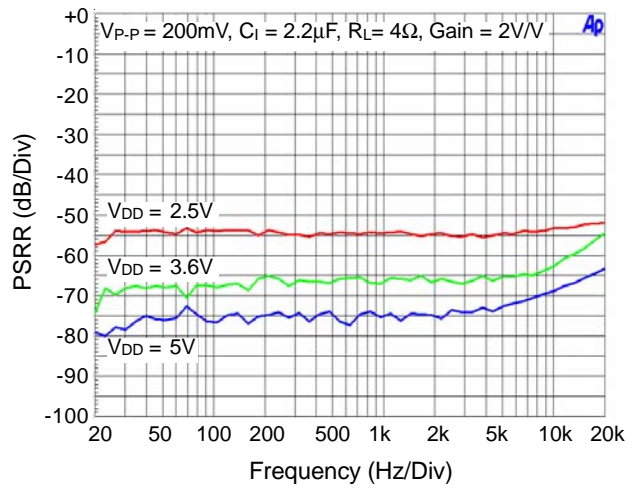

Power Dissipation vs. Output Power

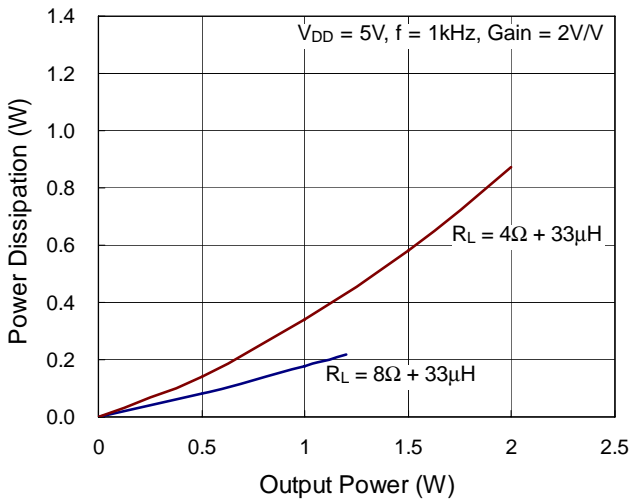

Power Dissipation vs. Output Power

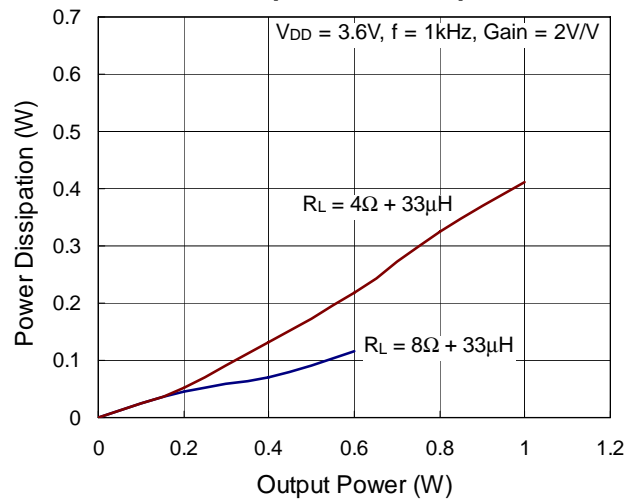

GSM Power Supply Rejection vs. Time

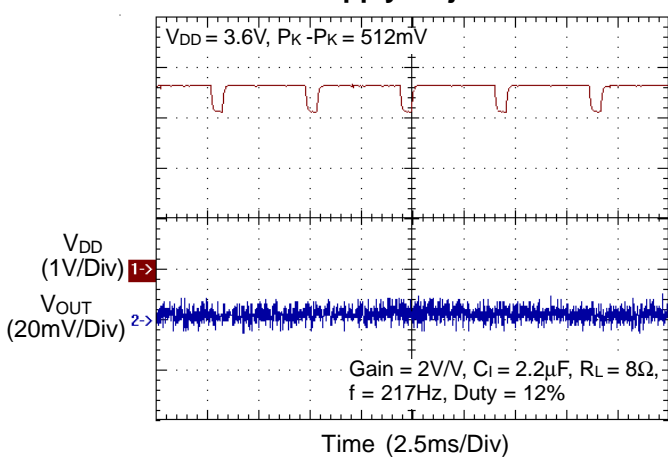

GSM Power Supply Rejection vs. Frequency

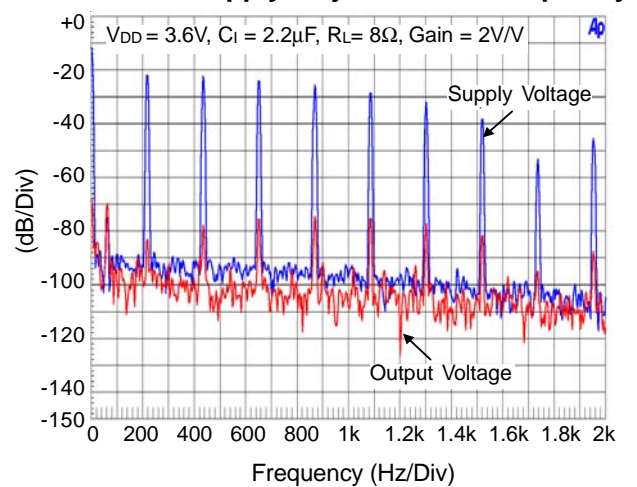

Application information

The RT9101 is a fully differential amplifier with differential inputs and outputs. The RT9101 integrates a differential amplifier and a common mode voltage controller. The differential amplifier ensures that the amplifier outputs a differential voltage on the output that is equal to the differential input times the gain. The RT9101 can support differential input and single ended input applications.

Components Selection

Input Resistors (R_I)

Amplifier can be resistors and the gain can be calculated as the following equation :

$$\text{Gain} = \frac{2 \times 150\text{k}\Omega}{R_I}$$

Resistor matching is very important in fully differential amplifiers. The balance of the output on the reference voltage depends on matched ratios of the input resistors. CMRR, PSRR, and the cancellation of the second harmonic distortion diminish if resistor mismatch occurs. Therefore, it is recommended to use 1% tolerance or better resistors to keep the performance optimized.

The input resistors should be placed very close to the RT9101 to limit noise injection on the high impedance nodes. It is recommended to set the gain at 2V/V or lower for better performance.

Decoupling Capacitor

The RT9101 is a high performance Class-D audio amplifier that requires adequate power supply decoupling to ensure the efficiency is high and total harmonic distortion (THD) is low. For higher frequency transients, spikes, or digital hash on the line, a good low Equivalent-Series-Resistance (ESR) ceramic capacitor, typically 1μF, placed as close as possible to the VDD pin can achieve the best performance. Placing this decoupling capacitor close to the RT9101 is very important for the efficiency of the Class-D amplifier, because any resistance or inductance in the trace between the device and the capacitor can cause a loss in efficiency. For filtering lower frequency noise signals, it is recommended to use a 10μF or greater capacitor placed near the audio power amplifier.

Input Capacitor

In the typical application, an input coupling capacitor (C_I) is required to allow the input signal to the proper dc level for optimum operation.

However, the RT9101 is a fully differential amplifier with good CMRR so that the RT9101 does not require input coupling capacitors if using a differential input source that is biased from 0.5 V to VDD – 0.8 V. Use 1% tolerance or better gain-setting resistors if input coupling capacitors are not used.

In the single-ended input application, an input capacitor, (C_I), is required to allow the amplifier to bias the input signal to the proper dc level. In this case, C_I and R_I form a high-pass filter with the corner frequency as shown in the following equation :

$$f_c = \frac{1}{2\pi R_I C_I}$$

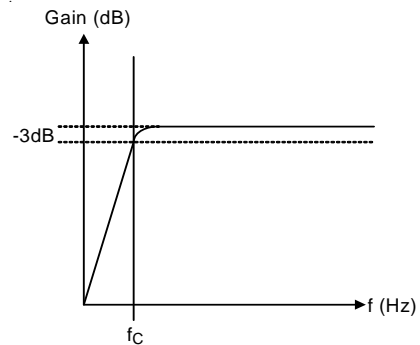

The value of C_I is important to consider as it directly affects the bass (low frequency) performance of the circuit. For example, the flat bass response requirement is 10 Hz and R_I is 20kΩ, the value of C_I can be calculated by the following equation :

$$C_I = \frac{1}{2\pi R_I f_c}$$

In this example, C_I is 0.8μF. A capacitance 1μF or larger can be used.

Under Voltage Lockout

The under voltage lock out circuit operates as a voltage detector and always monitors the supply voltage (VDD) while $\overline{\text{SHND}} = 1$. While powered on, the chip is kept still in shutdown mode until VDD rises to greater than 2.2V (typ). While powered off, the chip does not leave operation mode until VDD falls to less than 2.1V (typ).

Thermal Considerations

For continuous operation, do not exceed absolute maximum junction temperature. The maximum power dissipation depends on the thermal resistance of the IC package, PCB layout, rate of surrounding airflow, and difference between junction and ambient temperature. The maximum power dissipation can be calculated by the following formula :

$$P_{D(MAX)} = (T_{J(MAX)} - T_A) / \theta_{JA}$$

where $T_{J(MAX)}$ is the maximum junction temperature, T_A is the ambient temperature, and θ_{JA} is the junction to ambient thermal resistance.

For recommended operating condition specifications of the RT9101, the maximum junction temperature is 125°C and T_A is the ambient temperature. The junction to ambient thermal resistance, θ_{JA} , is layout dependent. For WDFN-8L 3x3 packages, the thermal resistance, θ_{JA} , is 70°C/W on a standard JEDEC 51-7 four-layer thermal test board. For WL-CSP-9B 1.45x1.45 (BSC) packages, the thermal resistance, θ_{JA} , is 80°C/W on a standard JEDEC 51-7 four-layer thermal test board. The maximum power dissipation at $T_A = 25^\circ\text{C}$ can be calculated by the following formula :

$$P_{D(MAX)} = (125^\circ\text{C} - 25^\circ\text{C}) / (70^\circ\text{C/W}) = 1.429\text{W for WDFN-8L 3x3 package}$$

$$P_{D(MAX)} = (125^\circ\text{C} - 25^\circ\text{C}) / (80^\circ\text{C/W}) = 1.250\text{W for WL-CSP-9B 1.45x1.45 (BSC) package}$$

The maximum power dissipation depends on the operating ambient temperature for fixed $T_{J(MAX)}$ and thermal resistance, θ_{JA} . For the RT9101 packages, the derating curves in Figure 3 allow the designer to see the effect of rising ambient temperature on the maximum power dissipation.

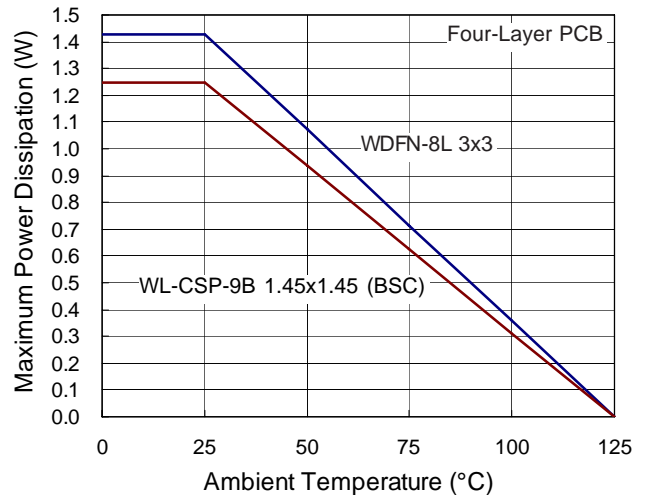

Figure 3. Derating Curves for RT9101 Packages

Layout Considerations

For best performance of the RT9101, the following PCB Layout guidelines must be strictly followed.

- ▶ Place the decoupling capacitors as close as possible to the VDD and GND pins.
- ▶ Keep the differential input and output traces as wide and short as possible. The traces of (INP & INN) and (OUTP & OUTN) should be kept equal width and length respectively.
- ▶ Connect the GND and Exposed Pad to a strong ground plane for maximum thermal dissipation and noise protection.

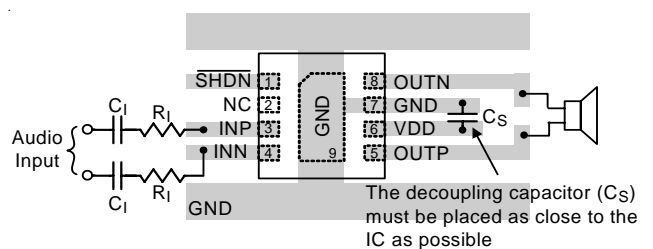
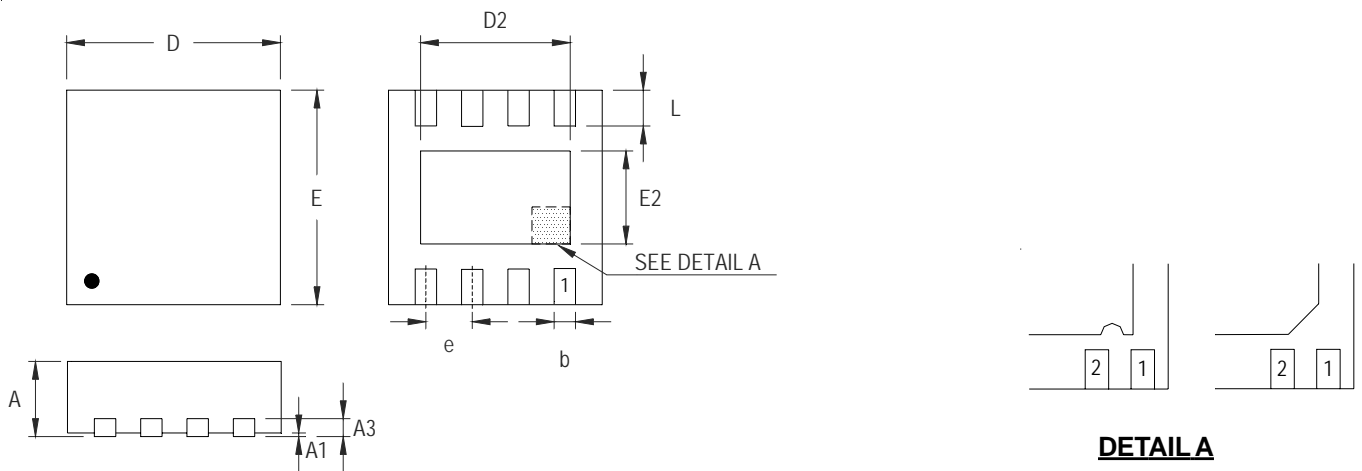

Figure 4. PCB Layout Guide

Outline Dimension



DETAIL A

Pin #1 ID and Tie Bar Mark Options

Note : The configuration of the Pin #1 identifier is optional, but must be located within the zone indicated.

Symbol	Dimensions In Millimeters		Dimensions In Inches	
	Min	Max	Min	Max
A	0.700	0.800	0.028	0.031
A1	0.000	0.050	0.000	0.002
A3	0.175	0.250	0.007	0.010
b	0.200	0.300	0.008	0.012
D	2.950	3.050	0.116	0.120
D2	2.100	2.350	0.083	0.093
E	2.950	3.050	0.116	0.120
E2	1.350	1.600	0.053	0.063
e	0.650		0.026	
L	0.425	0.525	0.017	0.021

W-Type 8L DFN 3x3 Package

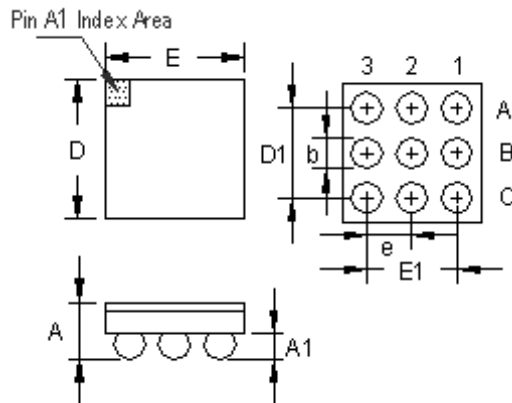

Symbol	Dimensions In Millimeters		Dimensions In Inches	
	Min	Max	Min	Max
A	0.525	0.625	0.021	0.025
A1	0.200	0.260	0.008	0.010
b	0.290	0.350	0.011	0.014
D	1.400	1.500	0.055	0.059
D1	1.000		0.039	
E	1.400	1.500	0.055	0.059
E1	1.000		0.039	
e	0.500		0.020	

9B WL-CSP 1.45x1.45 Package (BSC)

Richtek Technology Corporation

Headquarter
 5F, No. 20, Taiyuen Street, Chupei City
 Hsinchu, Taiwan, R.O.C.
 Tel: (8863)5526789 Fax: (8863)5526611

Richtek Technology Corporation

Taipei Office (Marketing)
 5F, No. 95, Minchiuan Road, Hsintien City
 Taipei County, Taiwan, R.O.C.
 Tel: (8862)86672399 Fax: (8862)86672377
 Email: marketing@richtek.com

Information that is provided by Richtek Technology Corporation is believed to be accurate and reliable. Richtek reserves the right to make any change in circuit design, specification or other related things if necessary without notice at any time. No third party intellectual property infringement of the applications should be guaranteed by users when integrating Richtek products into any application. No legal responsibility for any said applications is assumed by Richtek.