

| REVISIONS |     |                        |           |     |      |
|-----------|-----|------------------------|-----------|-----|------|
| REV       | ECO | DESCRIPTION            | DATE      | BY  | APPR |
| A3        | -   | RELEASE NEW DWG FORMAT | 18/JUN/13 | DRP | -    |

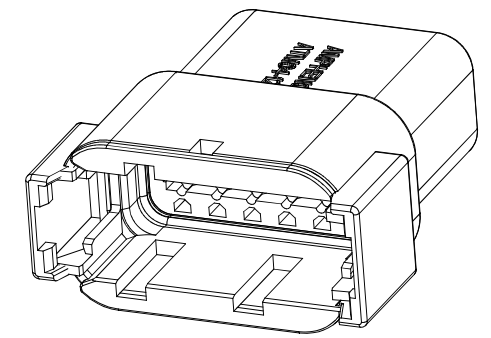

REQUIRES CONTACT RETENTION WEDGE AWM-8P

1 KEYWAY (3) PLACES

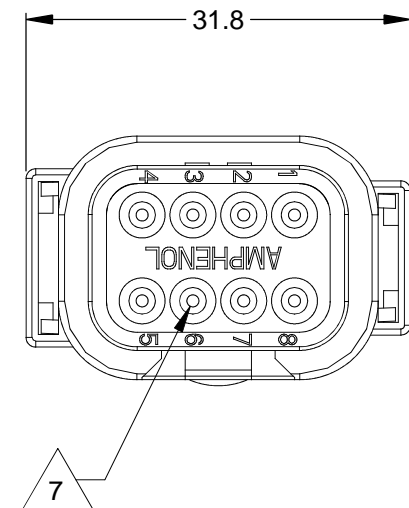
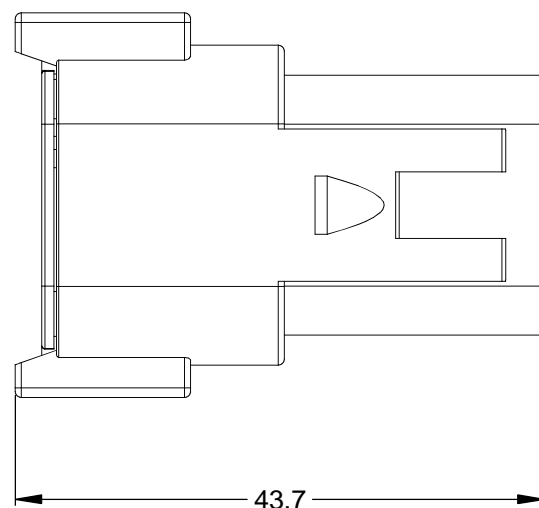
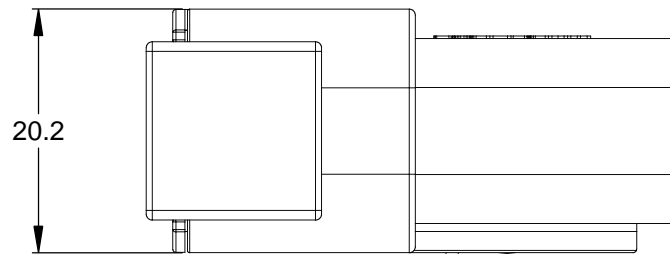
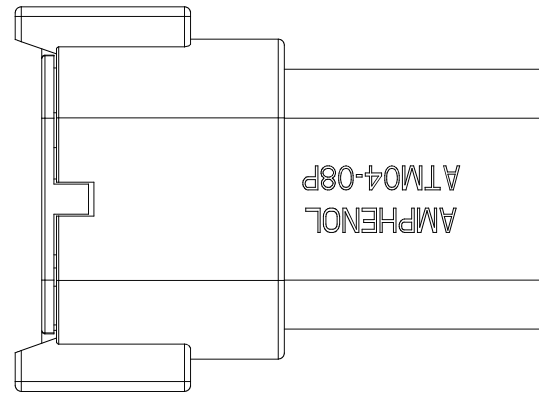
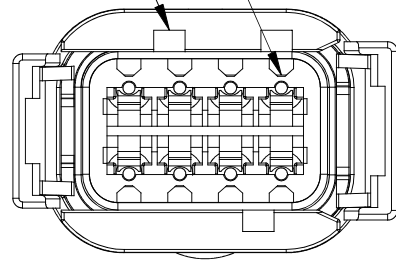

NOTES: UNLESS OTHERWISE SPECIFIED

1 SEE SHEET 2 FOR KEY ARRANGEMENTS AND COLORS.

2. MATERIAL:  
HOUSING: THERMOPLASTIC  
SEAL: SILICONE RUBBER

3. MODIFICATIONS: N/A

4. SPECIFICATIONS:  
4.1 CURRENT RATING: 7.5 AMPS  
4.2 OPERATING TEMPERATURE: -55°C TO +125°C.  
4.3 DIELECTRIC WITHSTANDING VOLTAGE: LESS THAN 2 MILLIAMPS CURRENT LEAKAGE @ 1500 VOLTS AC.  
4.4 INSULATION RESISTANCE: 1000 MEGOHMS MIN @ 25°C.  
4.5 MOISTURE RESISTANCE: IP67 ( MATED CONDITION )  
4.6 MATING CYCLE DURABILITY: 100 CYCLES  
4.7 RoHS COMPLIANT

5. MATING PART: ATM06-08SX\* PLUG.  
( X = A,B,C,D KEYS; \* = MODIFICATIONS AND COLORS )

6. ALL DIMENSIONS ARE FOR REFERENCE USE ONLY.

7 CONTACT SIZE AND REAR SEAL WIRE RANGE:

| CONTACT SIZE | MIN. INSUL O.D.   | MAX. INSUL O.D.   | TYPICAL WIRE RANGE |
|--------------|-------------------|-------------------|--------------------|
| 20           | 1.35 mm (.053 in) | 3.05 mm (.120 in) | 16 - 22 AWG        |

| QUANTITY   | SEE SHEET 2 PART NUMBER | DESCRIPTION  | ITEM                       |
|--|-------------------------|--|----------------------------|
| <b>MATERIALS LIST</b>  |                         |  |                            |
| UNLESS OTHERWISE SPECIFIED<br>1) All dimensions are in metric (mm).<br>2) Tolerances are as follows:<br>1 PL DEC ±0.30<br>2 PL DEC ±0.15<br>3 PL DEC ±0.08<br>Fractions ±1/64<br>Angles ±1°<br>3) Note reference = X |                         | SIGNATURES<br>DRAWN: D.PARKS<br>CHECKED:<br>ENGINEER:<br>APPROVAL:   | DATE<br>18/JUN/13          |
| MATERIAL SPECIFICATIONS:   |                         | <p style="text-align: center;"><b>Amphenol</b></p> <p style="text-align: center;">Sine Systems - www.amphenol-sine.com<br/>44724 Morley Drive<br/>Clinton Township, MI 48036</p> <p style="text-align: center;"><b>RECEPTACLE, KEYED, 8 PIN, ATM SERIES</b></p>      |                            |
| PROCESS SPECIFICATIONS:  |                         |  |                            |
| NEXT ASSY:   | CUSTOMER:               | THIS DRAWING IS SUPPLIED FOR INFORMATION ONLY. DESIGN FEATURES, SPECIFICATIONS AND PERFORMANCE DATA SHOWN HEREON ARE THE PROPERTY OF THE AMPHENOL CORPORATION. NO RIGHTS OF REPRODUCTION ARE IMPLIED. ALL DIMENSIONS ARE SUBJECT TO NORMAL MANUFACTURING VARIATIONS. |                            |
| SCALE: NONE  |                         | SIZE: <b>B C-</b>  | REVISION: <b>A3</b>        |
|  |                         | DWG NO: <b>ATM04-08PX-XXX</b>  | SHEET <b>1</b> OF <b>2</b> |

TITLE: RECEPTACLE, KEYED, 8 PIN, ATM SERIES  
DWG NO: ATM04-08PX-XXX  
REV: A3  
SH: 1  
OF: 2

| REVISIONS |     |             |      |    |      |
|-----------|-----|-------------|------|----|------|
| REV       | ECO | DESCRIPTION | DATE | BY | APPR |

P/N ATM04-08PA  
KEY-A CONFIGURATION  
STANDARD COLOR: GREY

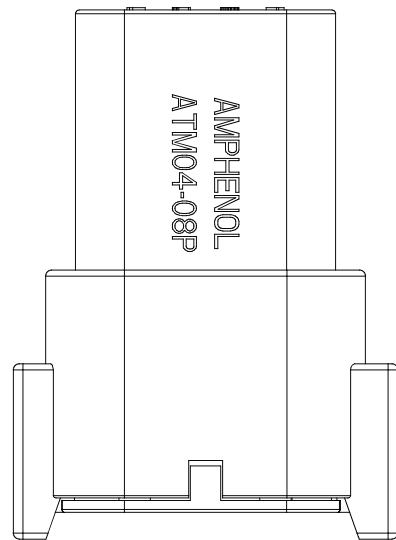

P/N ATM04-08PB  
KEY-B CONFIGURATION  
STANDARD COLOR: BLACK

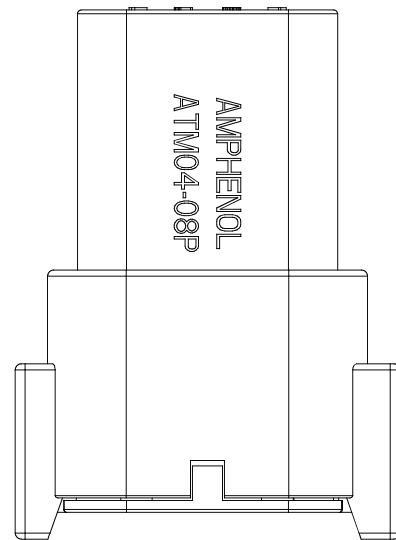

P/N ATM04-08PC  
KEY-C CONFIGURATION  
STANDARD COLOR: GREEN

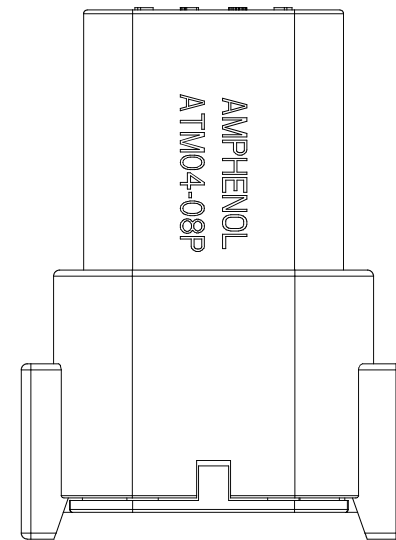

P/N ATM04-08PD  
KEY-D CONFIGURATION  
STANDARD COLOR: BROWN

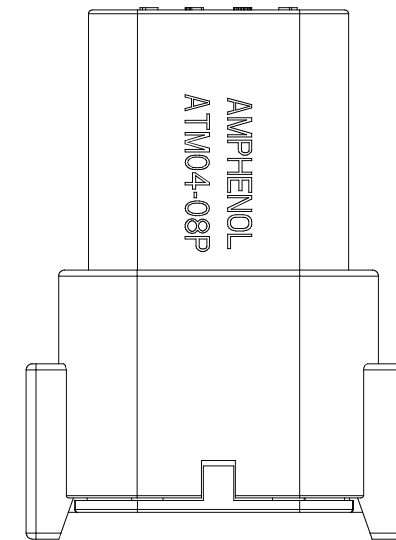

KEYWAY (3) PLACES

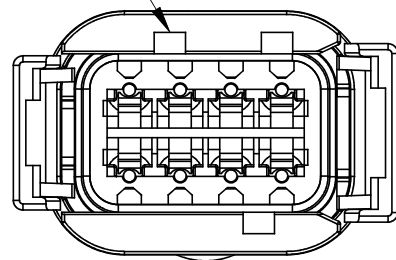

KEYWAY (3) PLACES

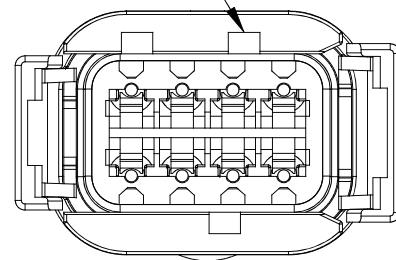

KEYWAY (3) PLACES

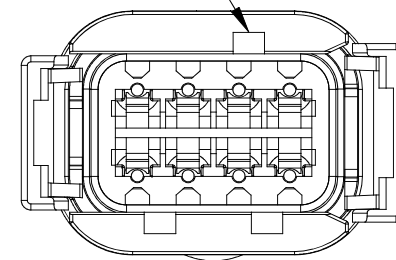

KEYWAY (3) PLACES

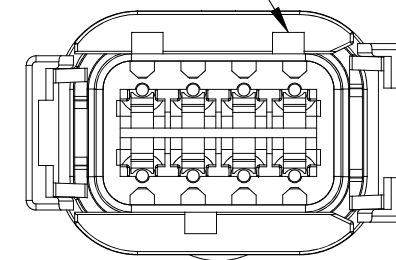

| KEY-A CONFIGURATION |                   |
|---------------------|-------------------|
| COLOR               | PART NUMBER       |
| <b>* GREY</b>       | <b>ATM04-08PA</b> |
| BLACK               | ATM04-08PA-BLK    |
| GREEN               | ATM04-08PA-GRN    |
| BROWN               | ATM04-08PA-BRN    |

| KEY-B CONFIGURATION |                   |
|---------------------|-------------------|
| COLOR               | PART NUMBER       |
| GREY                | ATM04-08PB-GRY    |
| <b>* BLACK</b>      | <b>ATM04-08PB</b> |
| GREEN               | ATM04-08PB-GRN    |
| BROWN               | ATM04-08PB-BRN    |

| KEY-C CONFIGURATION |                   |
|---------------------|-------------------|
| COLOR               | PART NUMBER       |
| GREY                | ATM04-08PC-GRY    |
| BLACK               | ATM04-08PC-BLK    |
| <b>* GREEN</b>      | <b>ATM04-08PC</b> |
| BROWN               | ATM04-08PC-BRN    |

| KEY-D CONFIGURATION |                   |
|---------------------|-------------------|
| COLOR               | PART NUMBER       |
| GREY                | ATM04-08PD-GRY    |
| BLACK               | ATM04-08PD-BLK    |
| GREEN               | ATM04-08PD-GRN    |
| <b>* BROWN</b>      | <b>ATM04-08PD</b> |

NOTE:

AN ASTERISKS ( \* ) PLACED BEFORE THE COLOR DENOTES THE STANDARD MOLDED COLOR OF THE CONNECTORS SHOWN ABOVE.



OTHER COLORS SHOWN ARE AVAILABLE VIA SPECIAL ORDER.

TITLE: RECEPTACLE, KEYED, 8 PIN, ATM SERIES  
DWG NO.: ATM04-08PX-XXX  
REV: A3  
SH: 2  
OF: 2





| QUANTITY   | PART NUMBER | DESCRIPTION  | ITEM                |
|--|-------------|--|---------------------|
| <b>MATERIALS LIST</b>  |             |  |                     |
| UNLESS OTHERWISE SPECIFIED<br>1) All dimensions are in metric (mm).<br>2) Tolerances are as follows:<br>1 PL DEC ±0.30<br>2 PL DEC ±0.15<br>3 PL DEC ±0.08<br>Fractions ±1/64<br>Angles ±1°<br>3) Note reference = |             | SIGNATURES DATE<br>DRAWN: D.PARKS 18/JUN/13<br>CHECKED:<br>ENGINEER:<br>APPROVAL:  |                     |
| MATERIAL SPECIFICATIONS:   |             | CUSTOMER:  |                     |
| PROCESS SPECIFICATIONS:  |             | THIS DRAWING IS SUPPLIED FOR INFORMATION ONLY. DESIGN FEATURES, SPECIFICATIONS AND PERFORMANCE DATA SHOWN HEREON ARE THE PROPERTY OF THE AMPHENOL CORPORATION. NO RIGHTS OF REPRODUCTION ARE IMPLIED. ALL DIMENSIONS ARE SUBJECT TO NORMAL MANUFACTURING VARIATIONS. |                     |
| NEXT ASSY:   |             | SCALE: NONE  |                     |
|  |             | <br>Sine Systems - www.amphenol-sine.com<br>44724 Morley Drive<br>Clinton Township, MI 48036<br><b>RECEPTACLE, KEYED, 8 PIN, ATM SERIES</b>  |                     |
|  |             | SIZE: <b>B C-</b>  | REVISION: <b>A3</b> |
|  |             | DWG NO.: <b>ATM04-08PX-XXX</b>   |                     |
|  |             | SHEET 2 OF 2   |                     |

# ATM Series™ - Contact Size 20 Options



| Machined Contacts, Sockets & Pins |  |      |       |          |
|-----------------------------------|--|------|-------|----------|
| Part Number                       | Description                            | Size | AWG   | Type     |
| AT60-010-2031                     | Male Contact - Pin, Gold-plated        | 20   | 16-18 | Machined |
| AT62-005-20141                    | Female Contact - Socket, Gold-plated   | 20   | 16-18 | Machined |
| AT60-010-20141                    | Male Contact - Pin, Nickel-plated      | 20   | 16-18 | Machined |
| AT62-005-2031                     | Female Contact - Socket, Nickel-plated | 20   | 16-18 | Machined |
| AT60-202-2031                     | Male Contact - Pin, Gold-plated        | 20   | 20-22 | Machined |
| AT62-201-2031                     | Female Contact - Socket, Gold-plated   | 20   | 20-22 | Machined |
| AT60-202-20141                    | Male Contact - Pin, Nickel-plated      | 20   | 20-22 | Machined |
| AT62-201-20141                    | Female Contact - Socket, Nickel-plated | 20   | 20-22 | Machined |

| Tooling - Machined Contacts   |             |   |
|---|-------------|---|
| Part  | Part Number | Description   |
|  | CA-5D12     | Universal Hand Crimp Tool, Size 12/16/20 (Machined contacts only) |
|  | CA-5E12     | Pneumatic Crimp Tool, Size 12/16/20 (Machined contacts only)      |

| Contact Removal Tools  |               |   |
|--|---------------|---|
| Part   | Part Number   | Description   |
|   | ART1-100      | Used for removal of contacts for A Series™ products |
|  | AT11-240-2005 | Contact Removal Tool, Plastic, Size 20              |

| Sealing Plugs   |                   |  |
|---|-------------------|--|
| Part  | Part Number       | Description                                      |
|  | AT13-204-2005     | Sealing Plug, Size 20, White                     |
|  | AT13-204-2005-SR  | Sealing Plug, Size 20, SR01 Series, Black        |
|  | ATM13-217-2005    | Locking Sealing Plug, Size 20, Grey              |
|  | ATM13-217-2005-SR | Locking Sealing Plug, Size 20, SR01 Series, Blue |

| Stamped & Formed Contacts, Sockets & Pins |  |      |       |                  |
|---|--|------|-------|------------------|
| Part Number                               | Description                            | Size | AWG   | Type             |
| AT60-20-0144                              | Male Contact - Pin, Gold-plated        | 20   | 16-22 | Stamped & Formed |
| AT62-20-0144                              | Female Contact - Socket, Gold-plated   | 20   | 16-22 | Stamped & Formed |
| AT60-20-0244                              | Male Contact - Socket, Gold-plated     | 20   | 16-22 | Stamped & Formed |
| AT62-20-0244                              | Female Contact - Socket, Gold-plated   | 20   | 16-22 | Stamped & Formed |
| AT60-20-0122                              | Male Contact - Pin, Nickel-plated      | 20   | 16-22 | Stamped & Formed |
| AT62-20-0122                              | Female Contact - Socket, Nickel-plated | 20   | 16-22 | Stamped & Formed |
| AT60-20-0222                              | Male Contact - Socket, Nickel-plated   | 20   | 16-22 | Stamped & Formed |
| AT62-20-0222                              | Female Contact - Socket, Nickel-plated | 20   | 16-22 | Stamped & Formed |
| AT60-20-0277                              | Male Contact - Socket, Tin-plated      | 20   | 16-22 | Stamped & Formed |
| AT62-20-0277                              | Female Contact - Socket, Tin-plated    | 20   | 16-22 | Stamped & Formed |
| AT60-20-0422                              | Male Contact - Socket, Nickel-plated   | 20   | 20-22 | Stamped & Formed |
| AT62-20-0444                              | Female Contact - Socket, Gold-plated   | 20   | 20-22 | Stamped & Formed |

| Tooling - Stamped & Formed Contacts   |             |   |
|---|-------------|---|
| Part  | Part Number | Description   |
|  | MFX-3974    | Crimp Die - Size 20 (S&F contacts only)                       |
|   | MFX-3976    | Crimp Die - Size 20 (S&F contacts only) 20-22AWG -04XX Series |
|   | MFX-3978    | Crimp Die - Size 20 (S&F contacts only) 20-22AWG -02XX Series |
|  | ATT-20-00   | Hand Crimp Tool - Size 20, 20AWG (S&F contacts only)          |

**Amphenol Sine Systems**  
 44724 Morley Drive  
 Clinton Township, MI 48036 USA  
[www.amphenol-sine.com](http://www.amphenol-sine.com)  
 03/2022