

# 3 Series Thumbwheel Switches

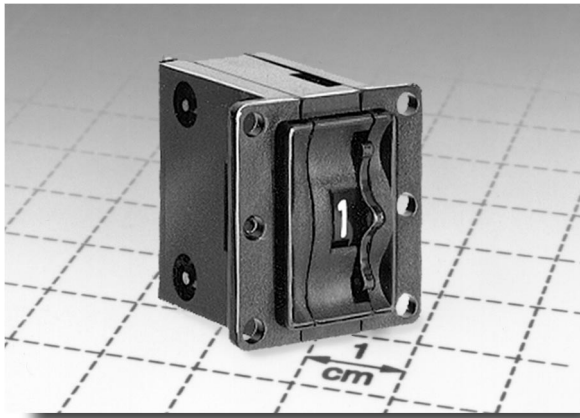

## Features/Benefits

- Most complete product offering in the industry
- Spacers available to fit most panel cutouts
- Front or rear mounting options
- Illuminated models available

## Typical Applications

- Test & measurement equipment
- Industrial equipment
- Computer devices

## Build-A-Switch

Our easy Build-A-Switch concept allows you to mix and match options to create the switch you need. Below is a complete listing of options shown in catalog. To order, simply select desired option from each category and place in the appropriate box. Available options are shown and described on pages J-9 thru J-16. For additional options not shown in catalog, consult Customer Service Center.



Thumbwheel & Pushwheel

Typical Example: 3 — 1 — 2 1 — 0 0 — 0 — 0 — 0 —  

### Series

**3** (STD.) Thumbwheel switch

### Number of Sections

- 0** Switch section
- 1** 1 Switch section
- 2** 2 Switch sections
- 3** 3 Switch sections
- 4** 4 Switch sections
- 5** 5 Switch sections
- 6** 6 Switch sections
- 7** 7 Switch sections
- 8** 8 Switch sections
- 9** More than 8 switch sections

### Function Code

- 11** Decimal, SP, 10 position
- 14** Resistor decade
- 21** BCD, 10 position
- 22** Octal, 8 position
- 23** Complement of BCD, 10 position
- 26** Complement of BCD, 10 position
- 27** BCD, 10 position
- 29** BCD, 10 position
- 31** BCD, 10 position
- 35** BCD with separate common to not true bits, 10 position
- 41** BCD with complement, 10 position
- 51** BCD with complement, 10 position
- 61** SPDT repeating, 10 position
- 71** BCH, 16 position
- 72** BCH, 16 position
- 99** Mixed sections

### Mounting Style

- 00** Snap-in, front mount
- 03** Snap-in, front mount
- 04** Snap-in, front mount
- 09** Snap-in, front mount
- 10** Rear mount
- 14** Rear mount
- 19** Rear mount
- 20** Rear mount
- 24** Rear mount
- 29** Rear mount
- 30** Snap-in, front mount
- 33** Snap-in, front mount
- 34** Snap-in, front mount

### Terminations

- 0** (STD.) Type 0
- 1** Type 1, extended type 0
- 3** Type 0 with solder pins
- 4** Type 4
- 5** Type 5, extended type 4
- 6** Type 6
- 9** Any combination
- A** Type 1 with solder pins
- B** Type 6 with solder pins
- E** Type 5 with solder pins

### Color/Marking/Stops

- 0** (STD.) Matte black body, gloss black wheel, white marking
- 1** Matte gray body, gloss black wheel, white marking
- 5** Matte black body, translucent off-white wheel, black marking
- 6** Matte gray body, translucent off-white wheel, black marking
- 9** Combination of body colors, wheel colors, marking and/or stops

### Seal

- 0** (STD.) No seal
- 1** Sealed contacts
- 2** Dust lens
- 3** Sealed contacts & dust lens
- 9** Sealing varies

### Illumination

- NONE** (STD.) No illumination
- 3** Red LED
- 5** Yellow LED
- 6** Green LED

## Specifications

CONTACT RATING:  
 CARRY: 1 AMP continuous.  
 SWITCH: 100 mA max.  
 OPERATING VOLTAGE: 50 mV to 28 V DC or 120 V AC.  
 ELECTRICAL LIFE: 100,000 actuations.  
 CONTACT RESISTANCE: Below 100 milliohms typ. initial @ 2-4 V DC, 100 mA.  
 INSULATION RESISTANCE: 10<sup>9</sup> ohms min.  
 DIELECTRIC STRENGTH: 500 V RMS min. @ sea level between common terminal and any output.  
 OPERATING TEMPERATURE: -10°C to 65°C.

## Materials

HOUSING: ABS plastic.  
 THUMBWHEEL: ABS plastic.  
 ROTOR CONTACTS: Precious metal on copper alloy.  
 STATOR CONTACTS: Hard gold over nickel over copper on epoxy fiberglass.

**NOTE:** Specifications and materials listed above are general specifications for switches with standard options. For information on specific and custom switches, consult Customer Service Center.

## SERIES

### 3 (STD.) THUMBWHEEL SWITCHES

PART NUMBER	NO. SECTIONS	NO. POSITIONS
31210000	1	10

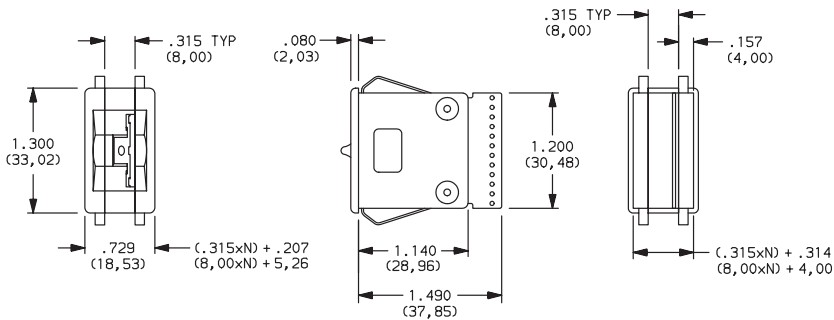

## NUMBER OF SECTIONS

- 0** Switch section only, no assembly. Blank bodies are considered sections; endplates are not sections. Must be ordered with 09 or 19 mounting style options, see pages J-11 and J-14.
- 1-8** Number of switch sections in assembly, includes endplates.
- 9** More than 8 switch sections, specify on CONFIGURATION FORM, page J-17 and consult Customer Service Center.

**NOTE:** Endplates and blank sections available separately, see section L.

## FUNCTION CODE

- 11** DECIMAL — 1 POLE; 10 POSITION
- 14** RESISTOR DECADE; 1-2-2-2 CODE (RESISTORS NOT SUPPLIED)
- 21** BCD 1-2-4-8; 10 POSITION
- 22** OCTAL 1-2-4; 8 POSITION (STOPPED BETWEEN 0-7 INCL.)
- 23** COMPLEMENT OF BCD 1-2-4-8; 10 POSITION

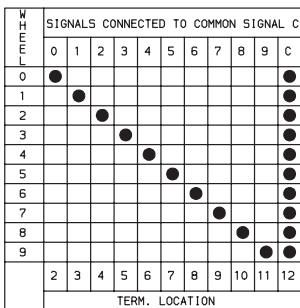

Available Terminations: 0, 1, 3, A  
 See fig. 1, page J-15.

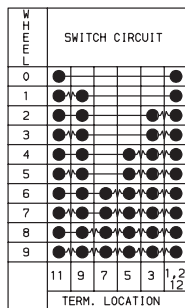

Available Terminations: 1, A  
 See fig. 1, page J-15.

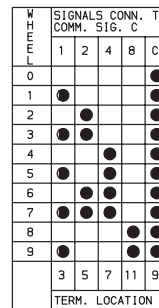
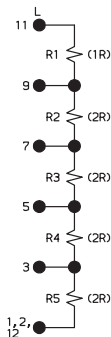

Available Terminations: 0, 1, 3, A  
 See fig. 1, page J-15.

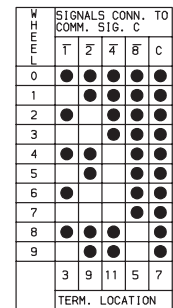

Available Terminations: 0, 1, 3, A  
 See fig. 1, page J-15.

**NOTE:** For terminal location diagram, see page J-15.

Thumbwheel & Pushwheel

# 3 Series Thumbwheel Switches



## FUNCTION CODE

**26** COMPLEMENT OF BCD 1-2-4-8;  
10 POSITION

W H E E L	SIGNALS CONN. TO			
	1	2	4	8
0	●	●	●	●
1	●	●	●	●
2	●	●	●	●
3	●	●	●	●
4	●	●	●	●
5	●	●	●	●
6	●	●	●	●
7	●	●	●	●
8	●	●	●	●
9	●	●	●	●
	4	5	1	2
	TERM. LOCATION			

Available Terminations: 6, B  
See fig. 2, page J-15.

**27** BCD 1-2-4-8; 10 POSITION

W H E E L	SIGNALS CONN. TO			
	1	2	4	8
0				●
1	●			●
2		●		●
3	●	●		●
4			●	●
5	●	●	●	●
6	●	●	●	●
7	●	●	●	●
8			●	●
9	●	●	●	●
	4	5	1	2
	TERM. LOCATION			

Available Terminations: 6, B  
See fig. 2, page J-15.

**29** BCD 1-2-4-8; 10 POSITION

W H E E L	SIGNALS CONN. TO			
	1	2	4	8
0				●
1	●			●
2		●		●
3	●	●		●
4			●	●
5	●	●	●	●
6	●	●	●	●
7	●	●	●	●
8			●	●
9	●	●	●	●
	2	3	4	5
	TERM. LOCATION			

Available Termination: B  
See fig. 2, page J-15.

**31** BCD 1-2-4-8; 10 POSITION

W H E E L	SIGNALS CONN. TO			
	1	2	4	8
0				●
1	●			●
2		●		●
3	●	●		●
4			●	●
5	●	●	●	●
6	●	●	●	●
7	●	●	●	●
8			●	●
9	●	●	●	●
	2	3	11	9
	TERM. LOCATION			

Available Terminations: 0, 1, 3, 4, 5, A, E  
See fig. 1, page J-15.

**35** BCD 1-2-4-8 W/ SEPARATE COMMON  
TO NOT TRUE BITS, 10 POSITION

W H E E L	SIGNALS CONN. TO					
	1	2	4	8	X	Y
0	○	○	○	○	○	○
1	●	○	○	○	○	○
2	○	○	○	○	○	○
3	●	○	○	○	○	○
4	○	○	○	○	○	○
5	●	○	○	○	○	○
6	○	○	○	○	○	○
7	○	○	○	○	○	○
8	○	○	○	○	○	○
9	●	○	○	○	○	○
	8	6	4	2	12	10
	TERM. LOCATION					

Available Terminations: 0, 1, 3, A  
See fig. 1, page J-15.

**41** BCD 1-2-4-8 W/ COMPLEMENT;  
10 POSITION

W H E E L	SIGNALS CONN. TO							
	1	2	4	8	T	Z	4	8
0					●	●	●	●
1	●				●	●	●	●
2		●			●	●	●	●
3	●	●			●	●	●	●
4			●		●	●	●	●
5	●	●	●		●	●	●	●
6	●	●	●		●	●	●	●
7	●	●	●		●	●	●	●
8				●	●	●	●	●
9	●	●	●		●	●	●	●
	10	9	8	7	3	4	5	6
	TERM. LOCATION							

Available Terminations: 0, 1, 3, A  
See fig. 1, page J-15.

**51** BCD 1-2-4-8 W/ COMPLEMENT;  
ONE COMMON, 10 POSITION

W H E E L	SIGNALS CONN. TO							
	1	2	4	8	T	Z	4	8
0					●	●	●	●
1	●				●	●	●	●
2		●			●	●	●	●
3	●	●			●	●	●	●
4			●		●	●	●	●
5	●	●	●		●	●	●	●
6	●	●	●		●	●	●	●
7	●	●	●		●	●	●	●
8				●	●	●	●	●
9	●	●	●		●	●	●	●
	5	4	3	2	10	9	8	7
	TERM. LOCATION							

Available Terminations: 0, 1, 3, 4, 5, A, E  
See fig. 1, page J-15.

**61** SPDT REPEATING; PLUS (+) AND  
MINUS (-) ALTERNATING,  
10 POSITION

W H E E L	SIG. CONN.	
	+	-
0	●	●
1	●	●
2	●	●
3	●	●
4	●	●
5	●	●
6	●	●
7	●	●
8	●	●
9	●	●
	9	8
	TERM. LOC	

Available Terminations: 0, 1, 3, 4, 5, A, E  
See fig. 1, page J-15.

**71** BINARY CODED HEXADECIMAL,  
16 POSITION

W H E E L	SIGNALS CONN. TO			
	1	2	4	8
0				●
1	●			●
2		●		●
3	●	●		●
4			●	●
5	●	●	●	●
6			●	●
7	●	●	●	●
8			●	●
9	●	●	●	●
A	●	●	●	●
B	●	●	●	●
C	●	●	●	●
D	●	●	●	●
E	●	●	●	●
F	●	●	●	●
	3	5	7	11
	TERM. LOCATION			

Available Terminations: 0, 1, 3, A  
See fig. 1, page J-15.

**72** BINARY CODED HEXADECIMAL,  
16 POSITION

W H E E L	SIGNALS CONN. TO			
	1	2	4	8
0				●
1	●			●
2		●		●
3	●	●		●
4			●	●
5	●	●	●	●
6			●	●
7	●	●	●	●
8			●	●
9	●	●	●	●
A	●	●	●	●
B	●	●	●	●
C	●	●	●	●
D	●	●	●	●
E	●	●	●	●
F	●	●	●	●
	2	3	4	5
	TERM. LOCATION			

Available Terminations: 6, B  
See fig. 2, page J-15.

**99** INTERMIXED SECTIONS, SPECIFY  
ON CONFIGURATION FORM,  
PAGE J-17 AND CONSULT  
CUSTOMER SERVICE CENTER

Available Terminations: Consult  
Customer Service Center.

NOTE: For terminal location diagram, see page J-15.

Thumbwheel & Pushwheel

## MOUNTING STYLE

### Type 0 Snap-In Front Mount

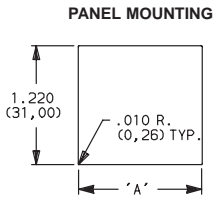

MOUNTING STYLE	DIM. 'A'
00	(.315 x N) + .326 (8,00 x N) + (8,28)
03	(.394 x N) + .326 (10,00 x N) + (8,28)
04	(.500 x N) + .326 (12,70 x N) + (8,28)

N = Number of sections.

Recommended panel thickness:  
.046 - .125  
(1,16 - 3,18)



### 00 SWITCH ASSEMBLY W/ ENDPLATES — .315 (8,00) SECTION PITCH

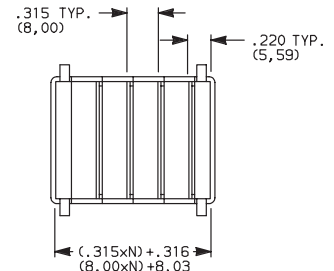
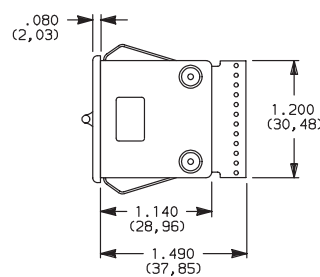
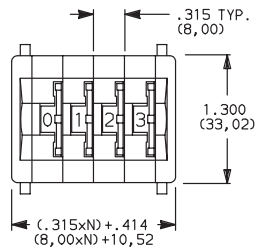

N = Number of sections.

### 03 SWITCH ASSEMBLY W/ ENDPLATES AND SPACER(S) — 10mm SECTION PITCH

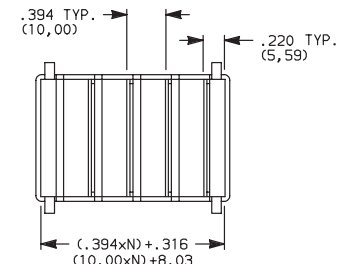
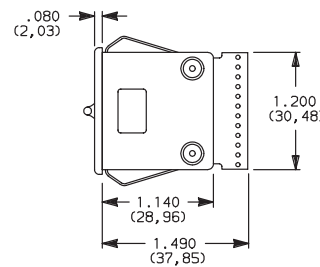
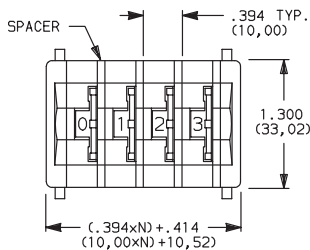

N = Number of sections.

### 04 SWITCH ASSEMBLY W/ ENDPLATES AND SPACER(S) — .500 (12,70) SECTION PITCH

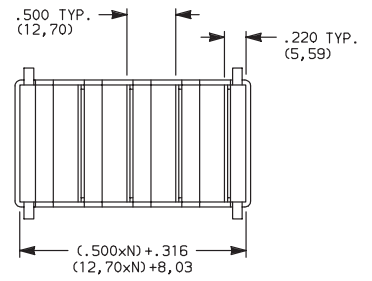
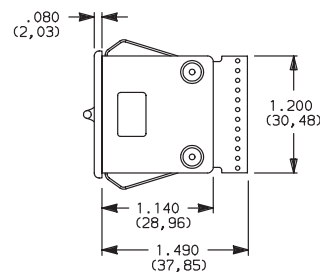
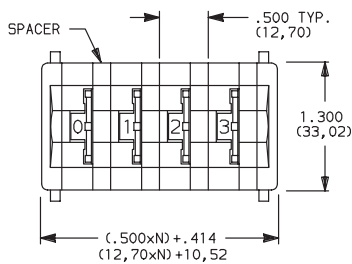

N = Number of sections.

### 09 SWITCH SECTION ONLY — UNASSEMBLED WITHOUT ENDPLATES OR SPACERS (Must be ordered with number of sections option "0", see Page J-9.)

**NOTE:** Endplates, blank sections, spacers and assembly hardware available separately, see section L.

# 3 Series Thumbwheel Switches



## MOUNTING STYLE

### Type 1 Rear Mount



MOUNTING STYLE	DIM. 'A'	DIM. 'B'
10	$(.350 \times N) + .340$ (8,89 x N) + (8,64)	$(.350 \times N) + .560$ (8,89 x N) + (14,22)
14	$(.500 \times N) + .340$ (12,70 x N) + (8,64)	$(.500 \times N) + .560$ (12,70 x N) + (14,22)

N = Number of sections.

Recommended panel thickness:  
.046 - .125  
(1,16 - 3,18)

### PANEL MOUNTING

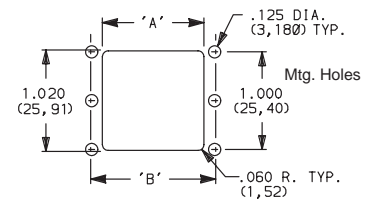

### 10 SWITCH ASSEMBLY W/ ENDPLATES — .350 (8,89) SECTION PITCH

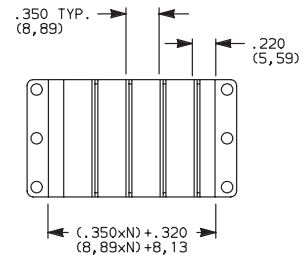
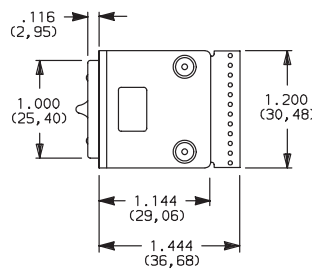
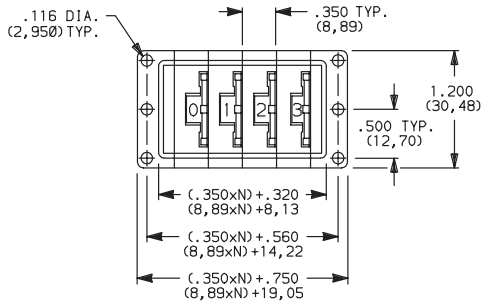

N = Number of sections.

### 14 SWITCH ASSEMBLY W/ ENDPLATES AND SPACER(S) — .500 (12,70) SECTION PITCH

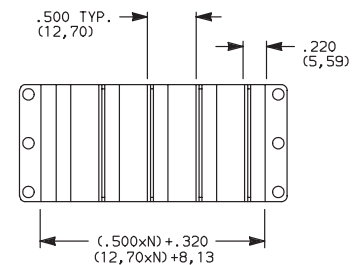
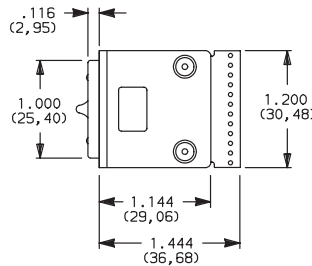
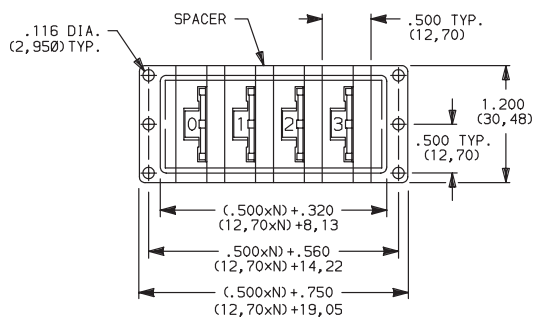

N = Number of sections.

### 19 SWITCH SECTION ONLY — UNASSEMBLED WITHOUT ENDPLATES OR SPACERS (Must be ordered with number of sections option "0", see Page J-9.)

NOTE: Endplates, blank sections, spacers and assembly hardware available separately, see section L.

Thumbwheel & Pushwheel

## MOUNTING STYLE

### Type 2 Rear Mount

#### PANEL MOUNTING

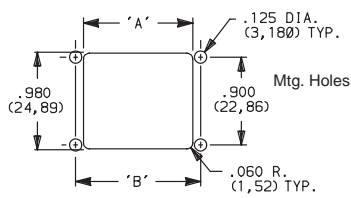

MOUNTING STYLE	DIM. 'A'	DIM. 'B'
20	$(.350 \times N) + .420$ (8,89 x N) + (10,67)	$(.350 \times N) + .590$ (8,89 x N) + (14,99)
24	$(.500 \times N) + .420$ (12,70 x N) + (10,67)	$(.500 \times N) + .590$ (12,70 x N) + (14,99)

N = Number of sections.

Recommended panel thickness:  
.046 - .125  
(1,16 - 3,18)

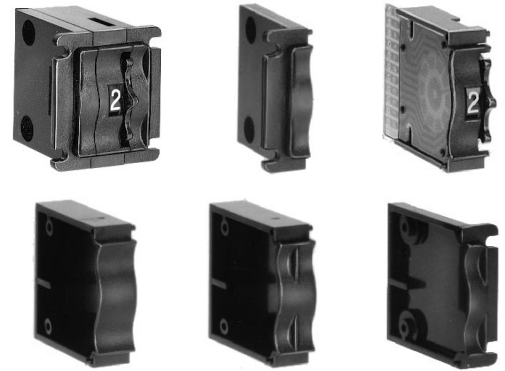

### 20 SWITCH ASSEMBLY W/ ENDPLATES — .350 (8,89) SECTION PITCH

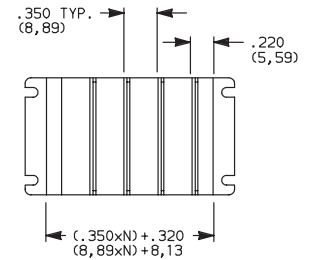
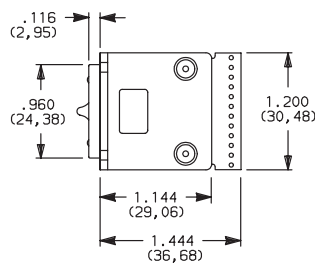
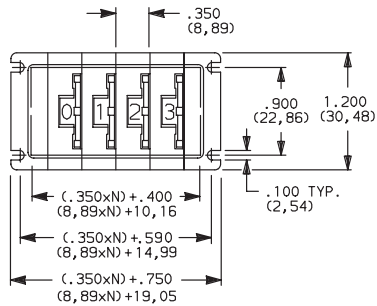

N = Number of sections.

### 24 SWITCH ASSEMBLY W/ ENDPLATES AND SPACER(S) — .500 (12,70) SECTION PITCH

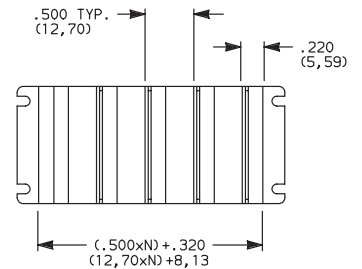
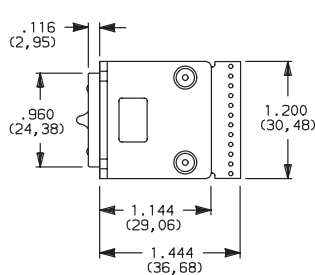
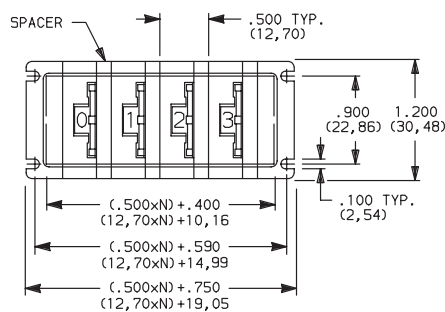

N = Number of sections.

### 29 SWITCH SECTION ONLY — UNASSEMBLED WITHOUT ENDPLATES OR SPACERS (Must be ordered with number of sections option "0", see Page J-9.)

NOTE: Endplates, blank sections, spacers and assembly hardware available separately, see section L.

# 3 Series Thumbwheel Switches



## MOUNTING STYLE

### Type 3 Snap-In Front Mount



MOUNTING STYLE	DIM. 'A'
30	$(.315 \times N) + .360$ (8,00 x N) + (9,14)
33	$(.394 \times N) + .360$ (10,01 x N) + (9,14)
34	$(.500 \times N) + .360$ (12,70 x N) + (9,14)

N = Number of sections.

Recommended panel thickness:  
.046 - .125  
(1,16 - 3,18)

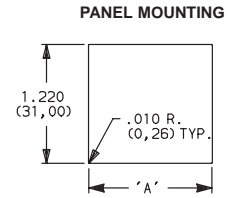

### 30 SWITCH ASSEMBLY W/ ENDPLATES — .315 (8,00) SECTION PITCH

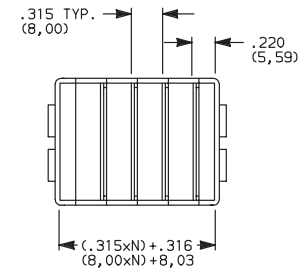
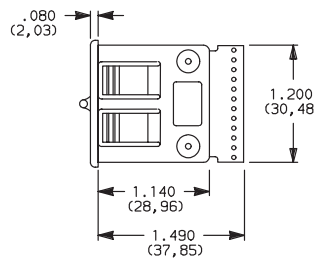
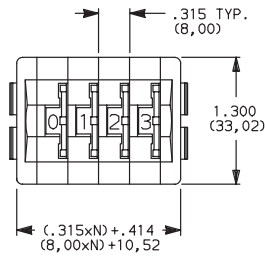

N = Number of sections.

### 33 SWITCH ASSEMBLY W/ ENDPLATES AND SPACER(S) — 10mm SECTION PITCH

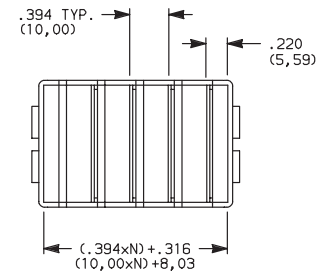
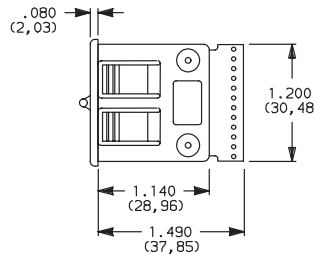
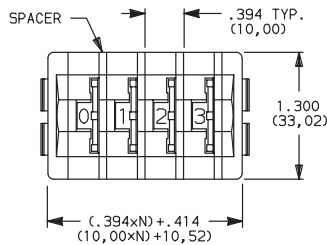

N = Number of sections.

### 34 SWITCH ASSEMBLY W/ ENDPLATES AND SPACER(S) — .500 (12,70) SECTION PITCH

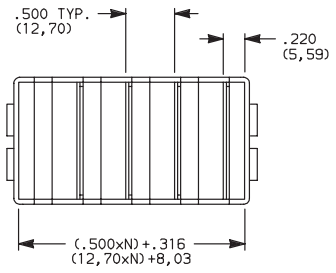
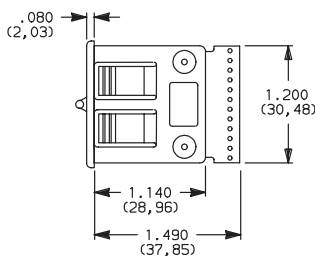
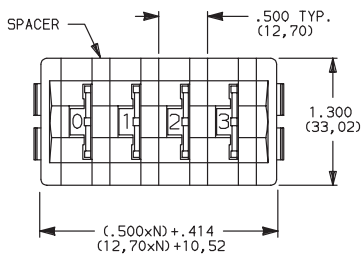

N = Number of sections.

### 09 SWITCH SECTION ONLY — UNASSEMBLED WITHOUT ENDPLATES OR SPACERS (Must be ordered with number of sections option "0", see Page J-9.)

NOTE: Endplates, blank sections, spacers and assembly hardware available separately, see section L.

## TERMINATIONS

### 0 (STD.) TYPE 0

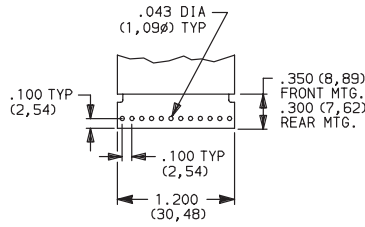

### 1 TYPE 1, EXTENDED TYPE 0

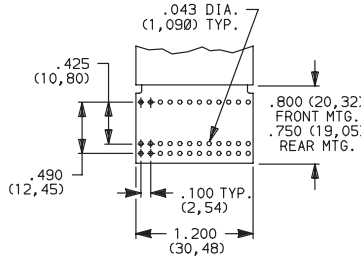

Signal traces cut except for common(s).

### 4 TYPE 4

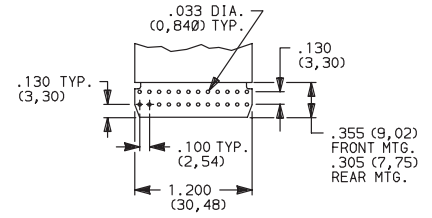

### 5 TYPE 5, EXTENDED TYPE 4

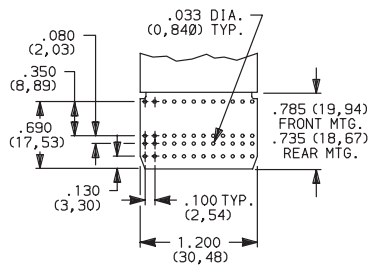

Signal traces cut except for common(s).

### 6 TYPE 6

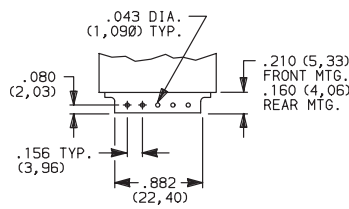

### 3 TYPE 0 WITH SOLDER PINS

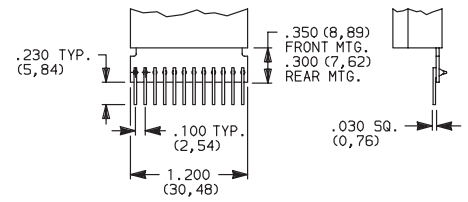

### A TYPE 1 WITH SOLDER PINS

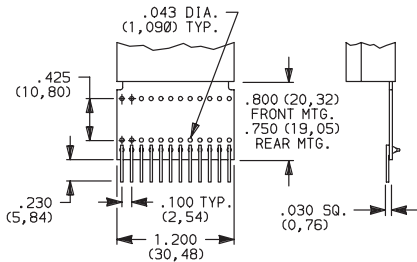

Signal traces cut except for common(s).

### B TYPE 6 WITH SOLDER PINS

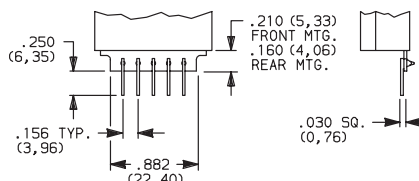

### E TYPE 5 WITH SOLDER PINS

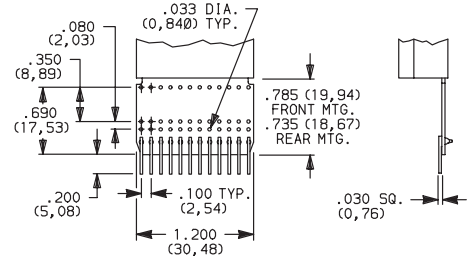

Signal traces cut except for common(s).

### 9 ANY COMBINATION OF TERMINATION CONFIGURATIONS OR SPECIAL TERMINATIONS. ALSO USED WITH FUNCTION CODES 91 AND 92.

Specify on configuration form, page J-17 and consult Customer Service Center.

PC Board 1/32" (0,79) thick.

**NOTE:** All terminal holes shown may not be present for all function codes, consult Customer Service Center. Terminal connector available for termination options 0, 1, 4 & 5, see section L.

## Terminal Location Numbers

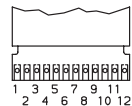

FIG. 1

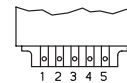

FIG. 2



**NOTE:** See function codes, pages J-9 and J-10, for signal locations.



# 3 Series Thumbwheel Switches



## COLOR/MARKING/STOPS

- 0** (STD.) MATTE BLACK HOUSING (Gloss black wheel with white characters; no stops.)
- 1** MATTE GRAY HOUSING (Gloss black wheel with white characters; no stops.)
- 5** MATTE BLACK HOUSING (Translucent off - white wheel with black characters; no stops, recommended with ILLUMINATION option.)
- 6** MATTE GRAY HOUSING (Translucent off - white wheel with black characters; no stops, recommended with ILLUMINATION option.)
- 9** SPECIAL COLOR OR MARKINGS FOR HOUSING OR WHEEL, STOPS (Specify on CONFIGURATION FORM, Page J-17 and consult Customer Service Center).  
 AVAILABLE COLORS: Marking: white, black  
 Body: black, gray (matte finish)  
 Wheel: white, black, red, orange, yellow, green, blue, brown, gray (gloss finish)

NOTE: Stop pins are available separately, see section L.

## SEAL

- 0** (STD.) UNSEALED SWITCHING CONTACTS.
- 1** SEALED SWITCHING CONTACTS. (Sealing is by means of an o-ring rotary seal and a cured-in-place elastomer gasket. Switching contact area is protected from moisture, oil, and airborne contaminants.)
- 2** DUST LENS. (Protects the character face of the wheel from abrasion and dirt, recommended with ILLUMINATION option).
- 3** SEALED SWITCHING CONTACTS AND DUST LENS. (options 1 and 2 recommended with ILLUMINATION option).
- 9** SEALING VARIATIONS, SECTION TO SECTION WITHIN ASSEMBLY. (Specify on CONFIGURATION FORM, page J-17 and consult Customer Service Center. Also specify with blank sections, where seal is not applicable).

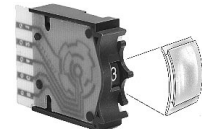

Dust Lens

## ILLUMINATION

- NONE** (STD.) NO ILLUMINATION
- 3** RED LED
- 5** YELLOW LED
- 6** GREEN LED

NOTE: Illumination option recommended with COLOR/MARKING/STOPS options 5, 6 and SEAL options 2 and 3. Illumination option not available with termination options with solder pins. Internal LED illuminates wheel characters for low-light visibility.

Thumbwheel & Pushwheel



# Configuration Form

GRAY SHADED AREAS TO BE FILLED IN BY C&K.

C&K CATALOG PART NO.

**3**

C&K PART NUMBER

C&K PART NUMBER

COMPANY NAME \_\_\_\_\_

ADDRESS \_\_\_\_\_ TEL.# \_\_\_\_\_

CUSTOMER CONTACT \_\_\_\_\_ DATE \_\_\_\_\_

ORIGINATED BY \_\_\_\_\_ SALES REP. \_\_\_\_\_

CUSTOMER  
PRINT  
REVISION:

DETAILS:

THUMBWHEEL SECTIONS	NO. OF SEC.	FUNCTION CODE — TERMINATIONS — COLOR/MARKING/STOPS/SEAL — ILLUMINATION <small>ENTER OPTION CODES IN APPROPRIATE BOXES. FUNCTION CODES INCLUDE BLANK SECTIONS (SEE CATALOG PAGE NO TAG).</small>	DESCRIBE IN APPROPRIATE ROW
	1	3 - <input type="text"/> <input type="text"/> - - <input type="text"/> <input type="text"/> <input type="text"/> <input type="text"/>	
	2	3 - <input type="text"/> <input type="text"/> - - <input type="text"/> <input type="text"/> <input type="text"/> <input type="text"/>	
	3	3 - <input type="text"/> <input type="text"/> - - <input type="text"/> <input type="text"/> <input type="text"/> <input type="text"/>	
	4	3 - <input type="text"/> <input type="text"/> - - <input type="text"/> <input type="text"/> <input type="text"/> <input type="text"/>	
	5	3 - <input type="text"/> <input type="text"/> - - <input type="text"/> <input type="text"/> <input type="text"/> <input type="text"/>	
	6	3 - <input type="text"/> <input type="text"/> - - <input type="text"/> <input type="text"/> <input type="text"/> <input type="text"/>	
	7	3 - <input type="text"/> <input type="text"/> - - <input type="text"/> <input type="text"/> <input type="text"/> <input type="text"/>	
	8	3 - <input type="text"/> <input type="text"/> - - <input type="text"/> <input type="text"/> <input type="text"/> <input type="text"/>	
	9	3 - <input type="text"/> <input type="text"/> - - <input type="text"/> <input type="text"/> <input type="text"/> <input type="text"/>	
	10	3 - <input type="text"/> <input type="text"/> - - <input type="text"/> <input type="text"/> <input type="text"/> <input type="text"/>	
	11	3 - <input type="text"/> <input type="text"/> - - <input type="text"/> <input type="text"/> <input type="text"/> <input type="text"/>	



Thumbwheel & Pushwheel

QUALITY CONTROL INSTRUCTIONS

PRODUCTION APPROVAL	DATE	
<input type="text"/>	<input type="text"/>	
Q.C. APPROVAL	DATE	
<input type="text"/>	<input type="text"/>	
REV.	INITIALS	DATE
<input type="text"/>	<input type="text"/>	<input type="text"/>

FOR SWITCHES WITH MORE THAN 11 SECTIONS, CONTINUE ON ADDITIONAL SHEETS.

SPECIAL INSTRUCTIONS OR SPECIFICATIONS:

SHEET \_\_\_\_ OF \_\_\_\_