

CONEC[®]

TECHNOLOGY IN CONNECTORS[™]

PCB CONNECTORS

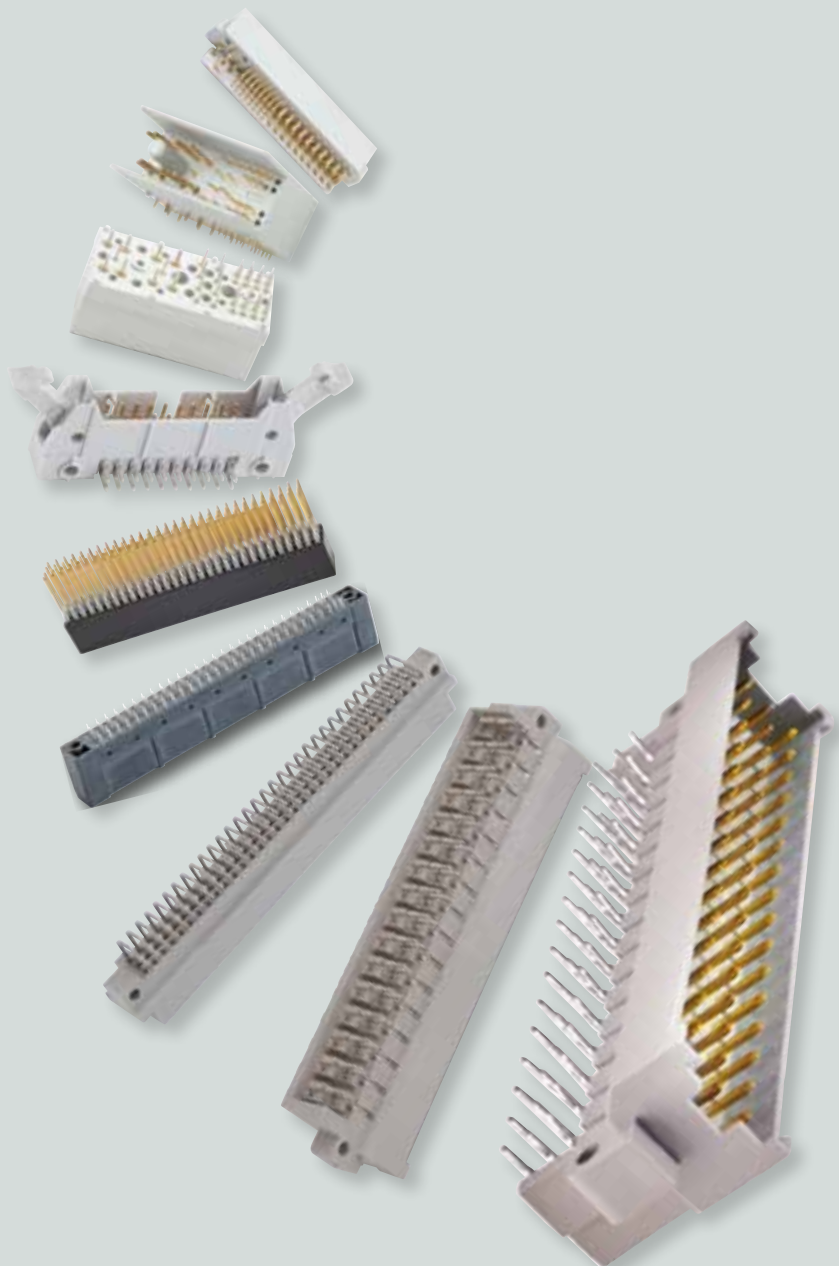



GERMANY

As a leading manufacturer of connectors, CONEC develops, produces and markets its products around the world to customers in the machine-tool, electronics and communications industries.

CONEC has dedicated itself to make a contribution to progress in the connector industry and to satisfy its customers through innovation, quality and excellent service. Around the world, our organization operates as a customer-oriented team.

CONEC is present in numerous countries with its own branch offices and representatives. Our local sales consultants transmit all information directly to the responsible departments to keep the paths of communication short. This provides support in the local language, quick response and competent consulting.

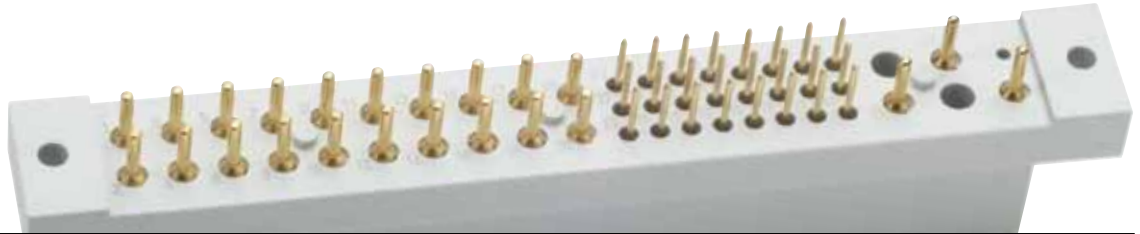

CANADA



USA

CONEC designs and manufactures products in modern facilities. The products are made in accordance to the highest quality standards and industry specifications.

CONEC provides reliable and effective solutions to OEM, EMS and cable houses.



OUR PHILOSOPHY – CUSTOMER SATISFACTION.



Quality is realized right from the beginning with Total Quality Management concept. Therefore our customers are included into all our processes, starting with design phase, first sampling, series production release and continuous sales support. The phases will be accompanied by drawings, samples and test reports. The entire quality process is documented and approved. CONEC is certified to ISO/TS16949:2002.

CONEC inhouse is equipped with modern test systems. We can verify the requirements and implement a continuous product improvement process to meet and exceed future requirements. To fulfill international and national requirements most of CONEC product series are registrated by UL, CSA or VDE.



CONEC IS YOUR SPECIALIST FOR DESIGN AND PRODUCTION OF SPECIAL CUSTOMIZED PRODUCTS.

Flexibility, assurance and rapid response are required in today's market more than ever before. CONEC fulfills these demands with central order-processing and well implemented quality control systems. Statistical process control as well as just in time deliveries are a common practice. Numerous customers honored this performance by approving CONEC to a "Preferred Supplier" status.



Are you looking for application-specific solutions?
Standard products do not meet your needs?
The implementation deadline is tight?

CONEC experienced design team can create your solution for you:

- Special Interconnect solutions to customers specifications
- Prototypes and small series production batches
- Connectors with increased IP ratings for harsh environments.

Contact us to discuss your special requirements.



PRODUCT LINES



I/O Connectors

D-SUB Connectors, Standard, Combination and Water Resistant; D-SUB Hoods and D-SUB accessories; Filter D-SUB Connectors, Standard, Combination and Water Resistant; Filter Adapters; Filter Plates; RJ45-IP67 Industrial Ethernet Connector System; USB 2.0-IP67 Connector System; RJ45 Magnetic Modular Jacks



PCB Connectors

DIN 41617 Connectors; DIN EN 60603-2 Connectors; DIN 41651 Insulation Displacement Connectors CompactPCI Connectors; AdvancedTCA Connectors; MicroTCA Connectors; PC104-, PC104plus Connectors; Pin Header and Socket Connectors



Sensor Actor Line / Circular Connectors

M12x1 Connectors, Overmolded and Field Attachable, Sockets, Junction Boxes, M12x1 Connector Systems for High Temperature, Food+Beverage, Bus Systems; M8x1 Overmolded Connectors; 7/8" Connectors; Rund24 Connectors; Valve Connectors



Fiber Optic Connectors











Adapter; Hybrid Adapter; Outdoor Connectors; Patch cords



Coaxial Connectors

SMA, SSMA, MMCX, TNC, N, MCX, Mixed Adapters and BNC Connectors; D-SUB and DIN Coaxial Contacts; D-SUB and DIN High-Current Contacts

INDEX

<p>SECTION 1 AdvancedTCA Connectors _____</p>	
<p>SECTION 2 MicroTCA Connectors _____</p>	
<p>SECTION 3 CompactPCI Connectors _____</p>	
<p>SECTION 4 Connectors DIN EN 60603-2 (DIN 41612) _____</p>	
<p>SECTION 5 Combination Connectors DIN EN 60603-2 (DIN 41612) _____</p>	
<p>SECTION 6 PC104 and PC104plus Connectors _____</p>	
<p>SECTION 7 Connectors DIN 41617 _____</p>	
<p>SECTION 8 Flatcable Connectors DIN 41651 _____</p>	
<p>SECTION 9 Installation and Assembly Tools _____</p>	
<p>SECTION 10 Part Numbers _____</p>	

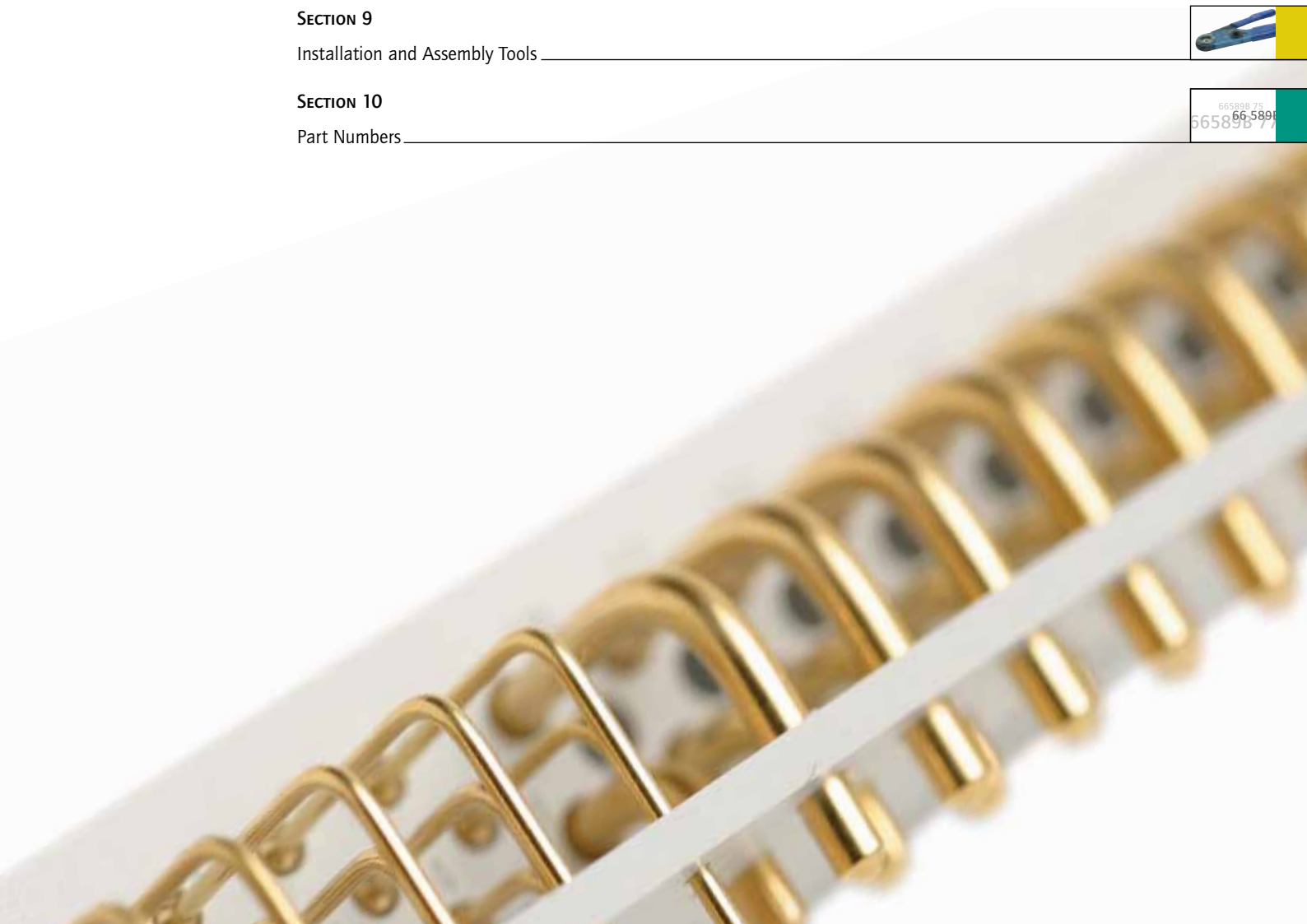

665895 75
665895 77

SECTION 1

ADVANCEDTCA CONNECTORS

This newly developed architecture and system layout allows manufacturers of telecom equipment a new standard for designing systems (PICMG 3.0). ATCA stands for: Advanced Telecommunications Computing Architecture

The basic structure is utilizing a modular concept. Application of this new structured approach allows various module designs that are compatible in layout and mechanical installation.

CONEC manufactured the power connectors for the ATCA-System which are used in Zone 1.

Advanced TCA[®]





The PICMG Group created the PICMG 3.0 Standard. This Standard specifies the mechanical details with regards to input/output, voltage, current and connection parameters. Control, backplane layout and system architecture are part of the standard.

CONEC has developed a new family of connector products that adhere to this new Standard. Products such as plugs and sockets, high power and signal contacts, have been developed.

This new connector series is available with press fit and through hole contact types.

Product features:

- Rugged construction
- Polarizing system
- Premating contacts
- Press fit contacts ("Eye of the needle")
- Selective loading of contact positions
- Screwdown hardware
- Special variations on request

CONEC is member of the PICMG Group.
For more information please visit
www.picmg.com.



TECHNICAL DATA

Materials	Precision machined contacts	Stamped contacts
Insulator	Glass filled plastic, UL 94V-0	
Contacts		
Materials	Copper alloy	
Plating	Gold flash over nickel / 0.8 µm gold over nickel (press fit design tin plated)	Gold flash over nickel / 0.8 µm gold over nickel gold over nickel (press fit design tin plated)

Electrical Characteristics	
Max. current rating, per UL 1977, (see temperature rise curve for details)	
Size 16 power contacts	30 A continuous all contacts under load
Size 22 signal contacts	2 A nominal rating
Initial contact resistance (termination to termination)	
Size 16 power contacts	0.0022 Ω max.
Size 22 signal contacts	0.0085 Ω max. 0.02 Ω max.
Insulation resistant	5 G Ω per IEC 512-2 Test 3a
Voltage proof	
Contacts 1 through 16	1000 V r.m.s.
Contacts 17 through 34	2000 V r.m.s.
Creepage and clearance distance (minimum)	
Contact positions 1 through 16 to any other contact within this group	0.7 mm
Contact positions 17 through 24 to any other contact within this group	2.5 mm
Contact positions 25 through 34 to any other contact within this group	1.4 mm
Contact positions 13 through 16 to 17 through 20	3.0 mm
Contact positions 21 through 24 to 25, 26	4.0 mm
Contact positions 25, 26 to 27 through 29	2.0 mm
Working voltage	100 V r.m.s.

Mechanical Characteristics	
Blind mating system	male and female connector bodies provide "lead-in" for 2.0 mm diametral misalignment
Polarization	provided by connector body design
Resistance to solder heat	260°C for 10 seconds duration per IEC 512-6, Test 12e 25-watt soldering iron (for other application contact factory)
Sequential contact mating system (succession)	<ol style="list-style-type: none"> 1. 25, 26, 28, 29, 30 and 31 2. 33 3. 34 4. contacts 1 to 24 mate before 27 and 32 (last mate)
Mechanical operations	250 cycles
Temperature range	-55°C to +125°C

Technical alterations are subjects to change without notice.

DIAGRAM

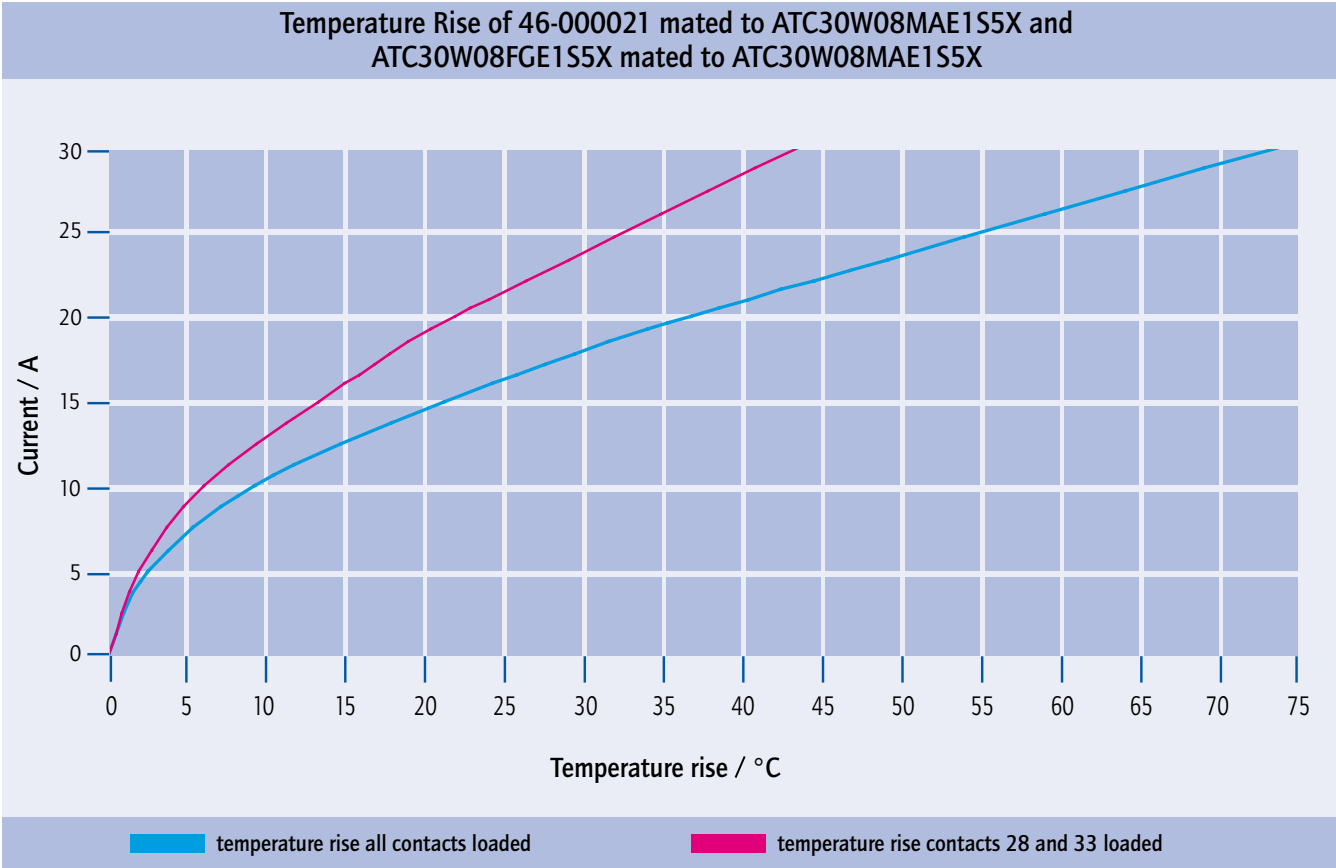

ADVANCEDTCA

Male Connector – angled – press fit – precision machined contacts



RoHS compliant – UL listed, File no.: E228329

DESCRIPTION

- Signal and power contacts
- Alternatively 22, 30 or 34 positions
- Eye of the needle press fit design, tin plated
- Precision machined contacts for mating area
- Mating area: gold plated quality class 1 or alternative quality class 3
- Special contact loadings possible on request

PRODUCT DRAWING

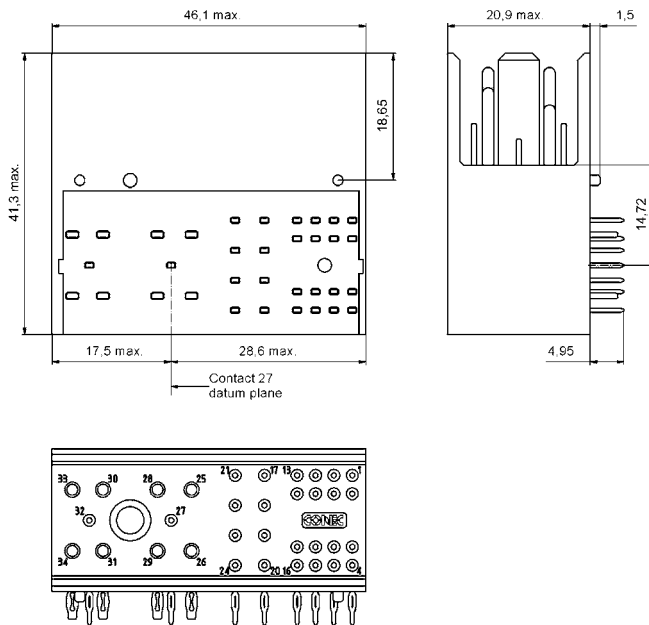

PCB-hole pattern (34 positions)

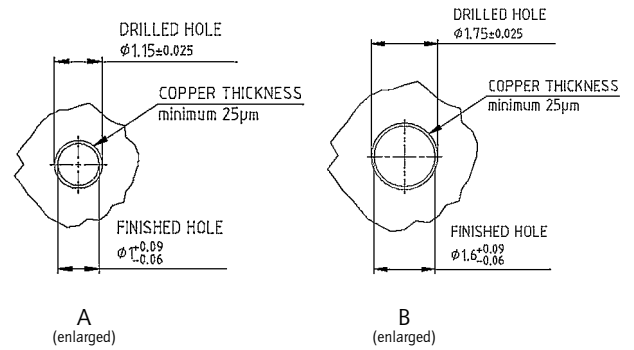
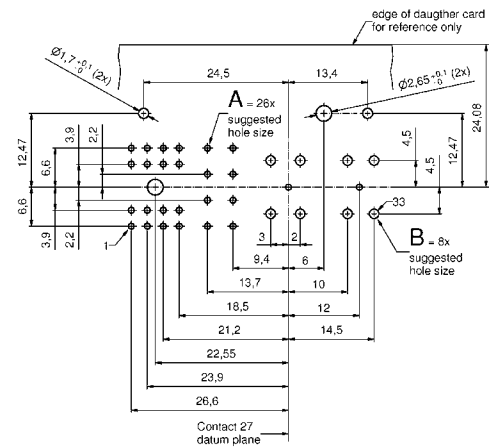

ORDER DATA

(Dim. = mm)

Number of positions	Contacts	Part number Quality class 3 (gold flash)	Part number Quality class 1 (0,8µm Au mating area)
22	14x signal / 8x power	ATC22 W08 MAE3S5 X	ATC22 W08 MAE1S5 X
30	22x signal / 8x power	ATC30 W08 MAE3S5 X	ATC30 W08 MAE1S5 X
34	26x signal / 8x power	ATC34 W08 MAE3S5 X	ATC34 W08 MAE1S5 X

ADVANCEDTCA

Female connector – straight – press fit – precision machined contacts

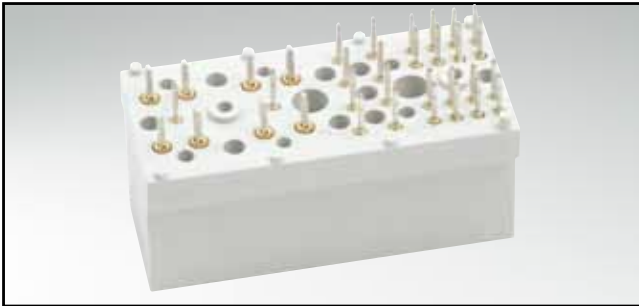

RoHS compliant – UL listed, File no.: E228329

DESCRIPTION

- Signal and power contacts
- Alternatively 22, 30 or 34 positions
- Eye of the needle press fit design, tin plated
- Precision machined contacts for mating area
- Mating area: gold plated quality class 1 or alternative quality class 3
- Special contact loadings possible on request

PRODUCT DRAWING

PCB-hole pattern (34 positions)

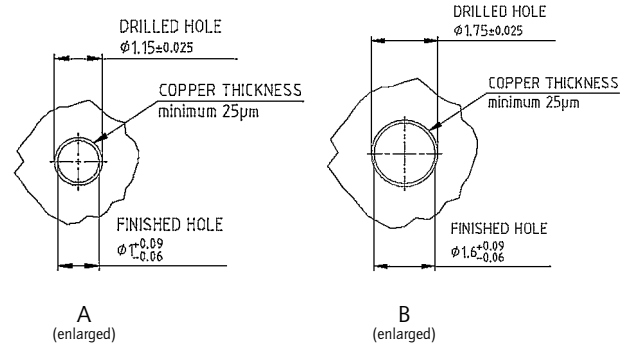
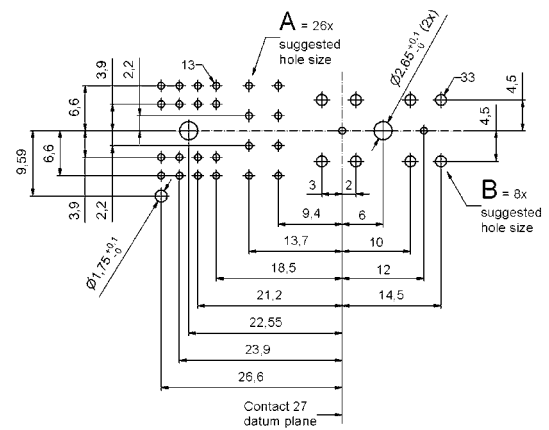
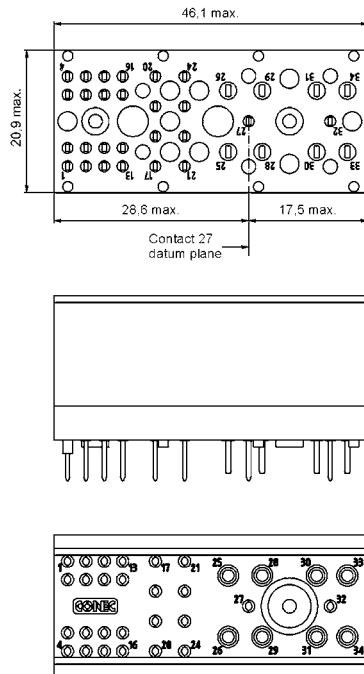

ORDER DATA

(Dim. = mm)

Number of positions	Contacts	Part number Quality class 3 (gold flash)	Part number Quality class 1 (0,8 μ m Au mating area)
22	14x signal / 8x power	ATC22 W08 FGE3S5 X	ATC22 W08 FGE1S5 X
30	22x signal / 8x power	ATC30 W08 FGE3S5 X	ATC30 W08 FGE1S5 X
34	26x signal / 8x power	ATC34 W08 FGE3S5 X	ATC34 W08 FGE1S5 X

ADVANCEDTCA

Male connector – angled – solder pin – precision machined contacts

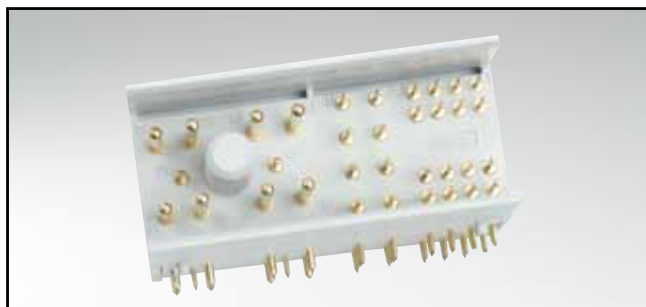

RoHS compliant – UL listed, File no.: E228329

DESCRIPTION

- Signal and power contacts
- Alternatively 22, 30 or 34 positions
- Mating area: gold plated quality class 1 or alternative quality class 3
- Special contact loadings possible on request

PRODUCT DRAWING

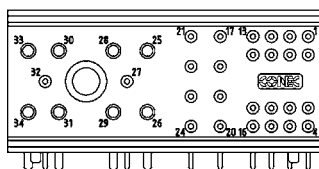
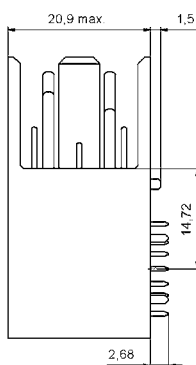
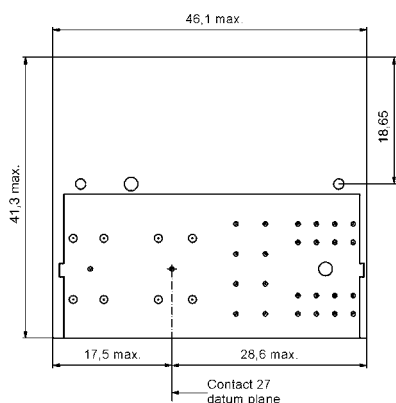

PCB-hole pattern (34 positions)

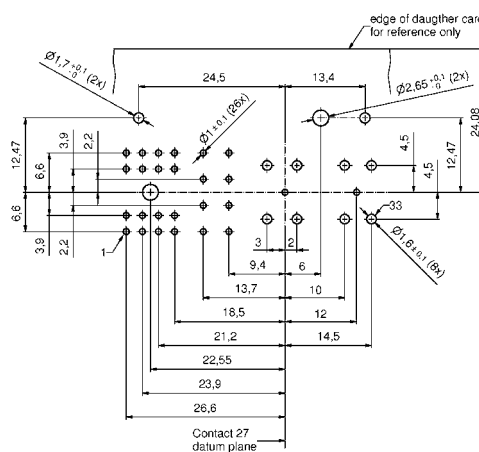

ORDER DATA

(Dim. = mm)

Number of positions	Contacts	Part number Quality class 3 (gold flash)	Part number Quality class 1 (0,8µm Au mating area)
22	14x signal / 8x power	ATC22 W08 MARAS5 X	ATC22 W08 MARCS5 X
30	22x signal / 8x power	ATC30 W08 MARAS5 X	ATC30 W08 MARCS5 X
34	26x signal / 8x power	ATC34 W08 MARAS5 X	ATC34 W08 MARCS5 X

ADVANCEDTCA

Female connector – straight – solder pin – precision machined contacts

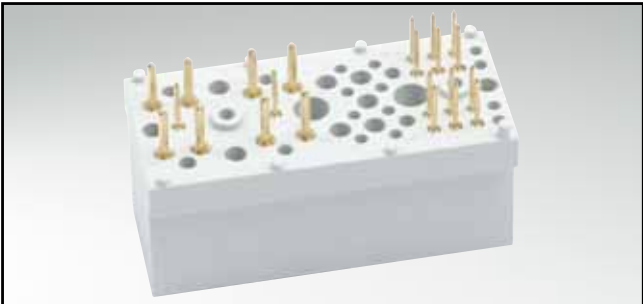

RoHS compliant – UL listed, File no.: E228329

DESCRIPTION

- Signal and power contacts
- Alternatively 22, 30 or 34 positions
- Mating area: gold plated quality class 1 or alternative quality class 3
- Special contact loadings possible on request

PRODUCT DRAWING

PCB-hole pattern (34 positions)

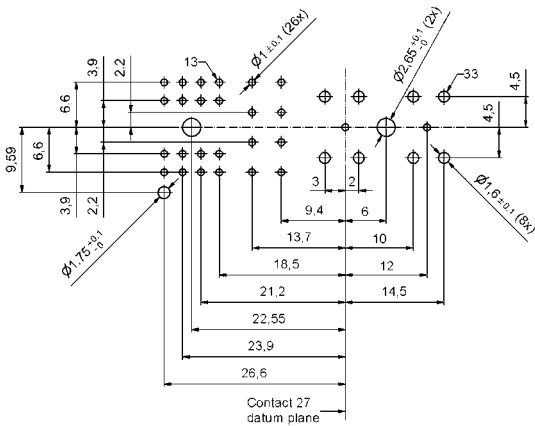
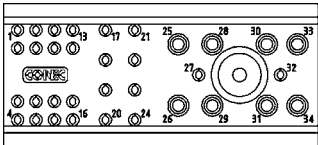
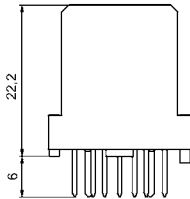
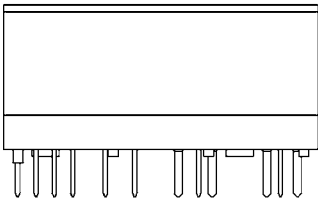
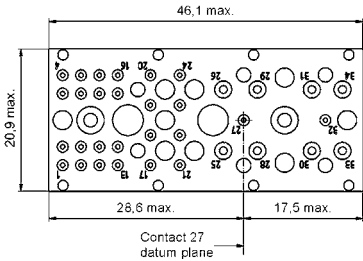

ORDER DATA

(Dim. = mm)

Number of positions	Contacts	Part number Quality class 3 (gold flash)	Part number Quality class 1 (0,8µm Au mating area)
22	14x signal / 8x power	ATC22 W08 FGRAS5 X	ATC22 W08 FGRCSS X
30	22x signal / 8x power	ATC30 W08 FGRAS5 X	ATC30 W08 FGRCSS X
34	26x signal / 8x power	ATC34 W08 FGRAS5 X	ATC34 W08 FGRCSS X

ADVANCEDTCA

Female connector – straight – press fit – stamped contacts

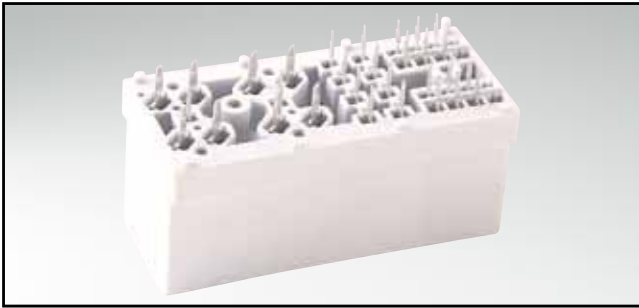

RoHS compliant

DESCRIPTION

- Signal and power contacts
- Alternatively 22, 30 or 34 positions
- Eye of the needle press fit design, tin plated
- Mating area: gold plated quality class 1 or alternative quality class 3
- Special contact loadings possible on request

PRODUCT DRAWING

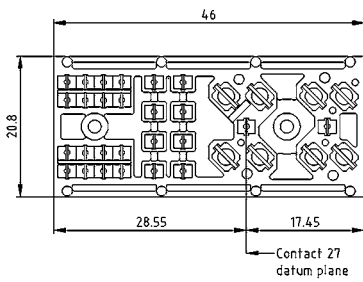

PCB-hole pattern (34 positions)

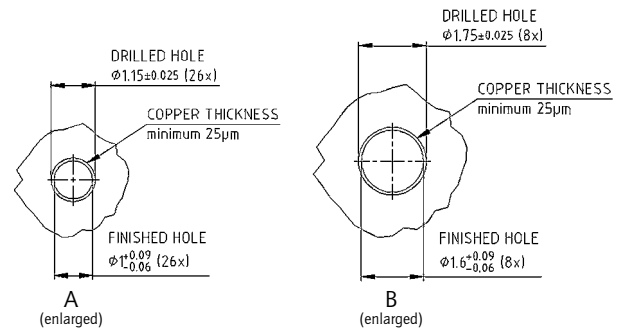
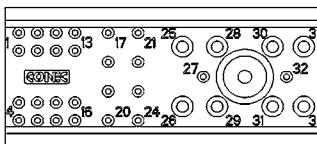
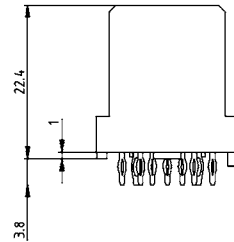
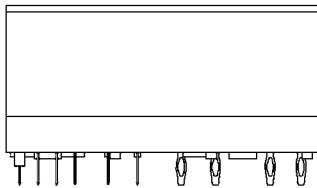
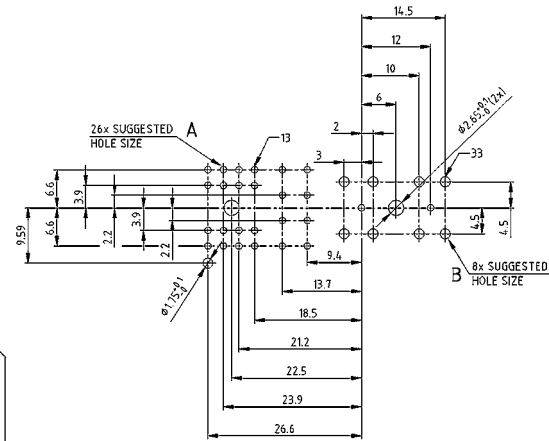

ORDER DATA

(Dim. = mm)

Number of positions	Contacts	Part number Quality class 3 (gold flash)	Part number Quality class 1 (0,8µm Au mating area)
22	14x signal / 8x power	46-000013	46-000011
30	22x signal / 8x power	46-000023	46-000021
34	26x signal / 8x power	46-000033	46-000031

Advanced TCA[®]

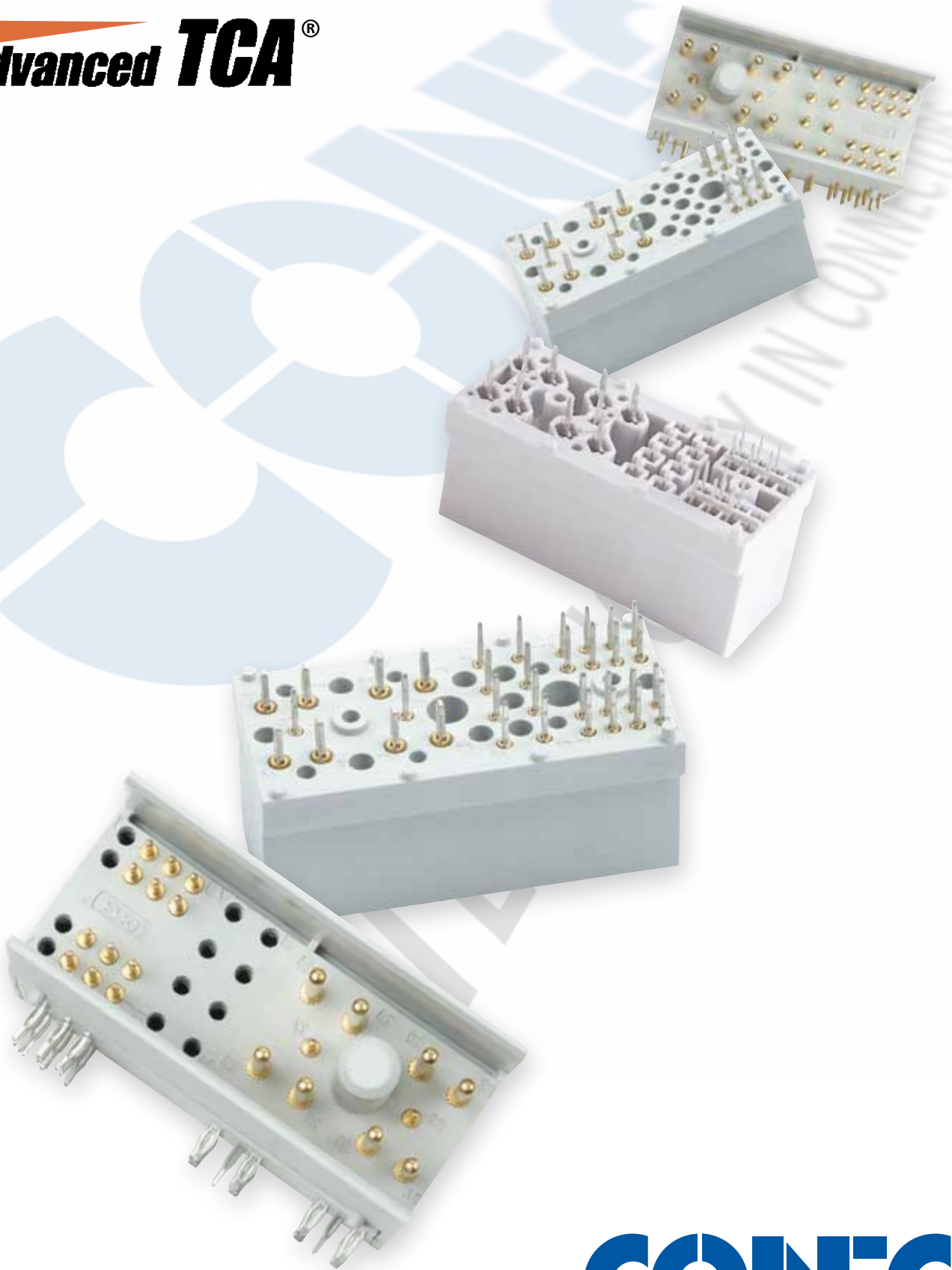

www.conec.com

CONEC[®]
TECHNOLOGY IN CONNECTORS[™]

SECTION 2

MICROTCA CONNECTORS

The MicroTCA system was developed beside the AdvancedTCA system to meet compact and cost effective requirements. This standard was also developed by the PICMG® group. Conec offers now the full range of interface connectors defined in the MicroTCA specification.

MicroTCA systems are modular constructed. The standard system configuration can consist of up to two Power Modules (PM's), two MicroTCA carrier hubs (MCH's) and up to 12 Advanced Mezzanine Cards (AMC's).

The MTCA.0 specification defines Combination D-SUB connectors type 7W2 and 9W4 as interfaces for the external power input to the power modules with direct voltage. These are populated with two power contacts, each with a current carrying capacity of 24 A per power pin for the 7W2 version (for use in power modules with -48/-60 V) and 49 A for the 9W4 version (module with +24 V) and two signal contacts.

Conec offers also special hoods in straight and angled version. These hoods are especially slim designed to fit into the MicroTCA connector footprint requirements.



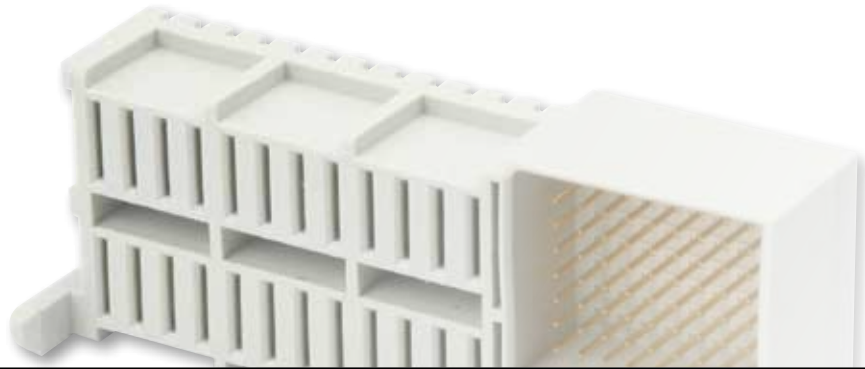

The energy will be supplied via power module output connectors from the PM into the MicroTCA backplane. This connector is a hybrid connector with 12 power contact pairs and 72 signal contacts in a 2.00 mm pitch. The angled version is applied to the PCB of the power module while the straight version is designed to be mounted on the system backplane. Alignment pins on the insulating body support the guide system of the module and allows a secured mating.

The current carrying capability is min. 9.3 A and a power module is able to supply the energy to twelve AMC Modules.

The interconnection from the MCH and the AMC modules to the backplane is made by the 170-pin high speed signal connector. This connector is a direct mating connector and allows data rates up to 12.5 Gbps. An additional internal conductive barrier supplies an additional shielding between the two signal layers. The connector is designed with „eye of the needle“ press fit contacts and will be installed into the systems backplane securely and without soldering.



TECHNICAL DATA

(AdvancedMC Connector)

Materials		
Housing	Liquid Crystal Polymer (LCP), UL 94-V0	
Contacts	Copper alloy	
Contact plating	Mating area gold over nickel	Termination area tin over nickel
Electrical characteristics		
Insulation resistance (IEC 60512)	General purpose contacts	0.4 A min.
	Ground contacts	0.3 A min.
	Power contacts	1.52 A min.
	Differential pair contacts	0.1 A min.
Contact resistance	25 mΩ	
Insulation resistance	100 MΩ	
Differential Impedance	100 Ω ± 10%	
Crosstalk	3 % (Multi aggressor condition)	
Differential skew	< 5 ps	
Mechanical Characteristics		
Mating cycles	200	
Mating force	100 N max.	
Withdrawal force	65 N max.	

Technical alterations are subjects to change without notice.

ADVANCEDMC CONNECTOR

Press fit technology – MicroTCA – for high speed signals

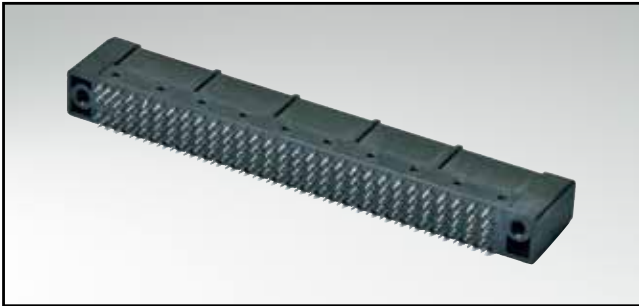

RoHS compliant

DESCRIPTION

- 170 "high speed" signal contacts
- Direct connector for AMC module
- Data transfer rates up to 12.5 Gbps
- Internal shielding
- Eye of the needle press fit
- Mating area gold plated, quality class 1

PRODUCT DRAWING

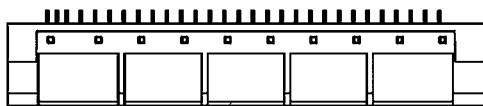
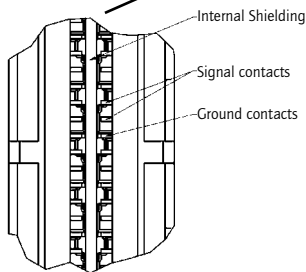
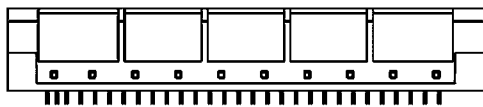

6,95 measured to bottom of card slot

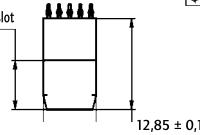

PCB-hole pattern

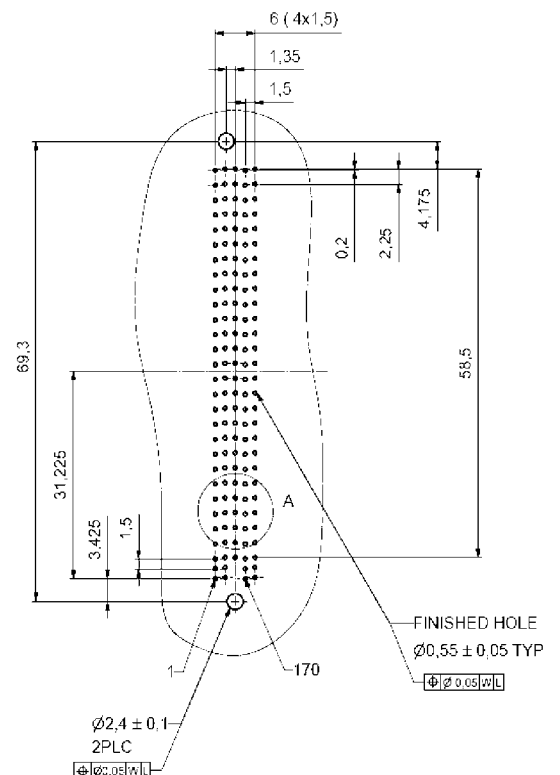

ORDER DATA

(Dim. = mm)

Number of positions	Part number
170	47-000001

TECHNICAL DATA

(Backplane and Power Modul Output Connector)

Materials		
Housing	Thermoplastic polyester, glass filled; UL94-V0	Color: grey
Power contacts	Copper alloy	Mating area gold over nickel Termination area tin plated
Signal contacts	Copper alloy	Termination gold over nickel Termination area tin plated
Electrical characteristics		
Insulation resistance (IEC 60512)	Power contacts and GND contacts	9.3 A per pin at max. 30°C temperature rise
	Signal- and Signal GND contacts	0.5 A at max. 30°C temperature rise
Contact material	Power contacts and GND contacts	11.625 A
	Signal- and Signal GND contacts	0.625 A
Contact resistance	Power contacts and GND contacts	5 mΩ
	Signal- and Signal GND contacts	25 mΩ
Insulation resistance	Power contacts	100 MΩ min.
	Signal contacts	100 MΩ min.
Temperature range	-55°C to +105°C	
Mechanical characteristics		
Mating cycles	200	
Mating force	145 N max.	
Withdrawal force	110 N max.	

Technical alterations are subjects to change without notice.

BACKPLANE CONNECTOR

Press fit technology – straight version

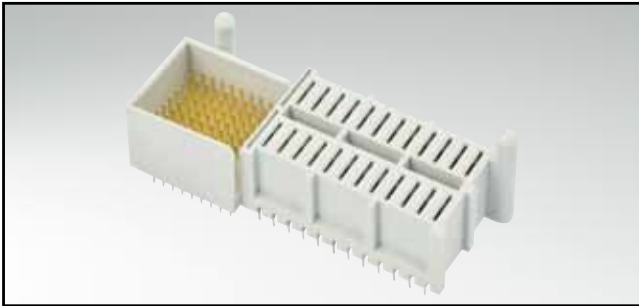

RoHS compliant

DESCRIPTION

- Connector according to MicroTCA specification
- Combination of signal- and power contacts
- Eye of the needle press fit
- Mating area gold plated, quality class 1

PRODUCT DRAWING

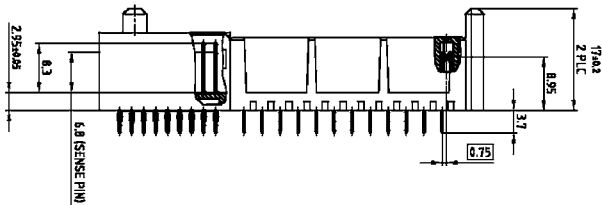

PCB-hole pattern

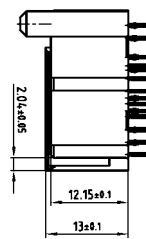
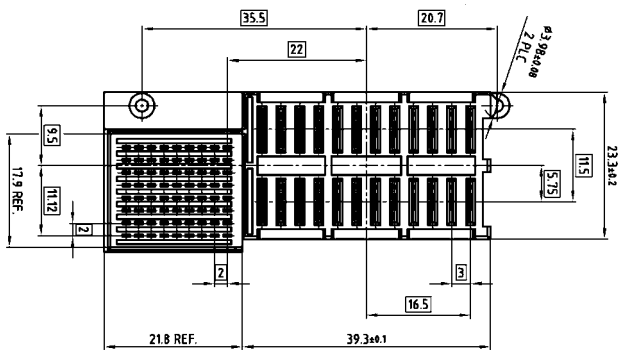
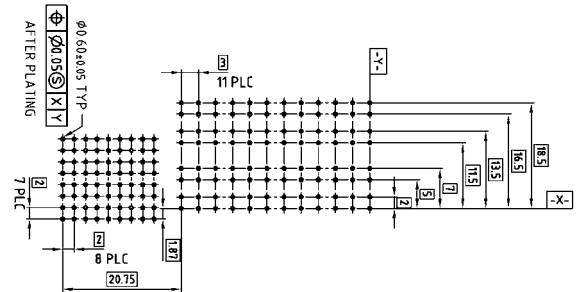

ORDER DATA

(Dim. = mm)

Number of positions	Contacts	Part number
96	72x signal / 24x power	47-100001

TECHNICAL DATA

Power Module Input Connector

Materials		
Insulator	PBT (UL 94-V0)	
Power Contacts	Copper alloy, Precision machined contacts	Mating side gold over nickel Soldering side tin over nickel
Signal contacts	Copper alloy, Precision machined contacts	Mating side gold over nickel Soldering side gold over nickel
Shell	Steel	Tin plated
Mounting bracket	Zink die-cast	Tin plated
4-40 UNC threaded insert	Copper alloy	Tin plated
Hex bolt with 4-40 UNC threaded insert and washers	Steel	Nickel plated
PCB clip for 1.6 mm PCB LP	Copper alloy	Tin plated
Electrical characteristics		
Current rating	Power contacts	24 A at max. 30°C temperature rise
	Signal contacts	7.5 A nominal
Clearance- and creepage distance	Power contacts	1.5 mm min.
	Signal contacts	0.4 mm min.
	Signal and power contacts	1.5 mm min.
	Power contacts and shell	1.5 mm min.
	Signal contacts and shell	1.5 mm min.
Insulation resistance	Power contact	5000 MΩ min.
	Signal contact	5000 MΩ min.
	Signal and power contacts	5000 MΩ min.
	Power contacts and shell	5000 MΩ min.
	Signal contacts and shell	5000 MΩ min.
Dielectric with standing voltage	1000 V r.m.s.	
Mechanical characteristics		
Mating cycles	250	
Mating force	100 N max.	
Unmating force	65 N max.	

Technical alterations are subjects to change without notice.

POWER MODUL INPUT CONNECTORS

Plug connector – solder pin – angled – precision machined contacts – dual port style – through hole solder type

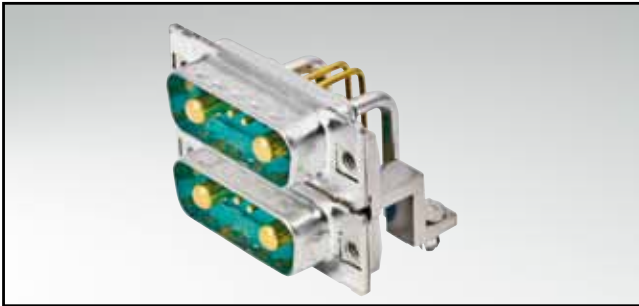

RoHS compliant

DESCRIPTION

- Standard version according to MTCA specification
- Design 7W2 for -48/-60 V Power modul
- 2 power contacts 24 A / 2 signal contacts per port
- Mounting styles:
 - Mounting bracket with PCB clip, 4-40 UNC threaded insert
 - Mounting bracket with PCB clip, 4-40 UNC hex bolt
- Note for 9W4 product please contact factory

PRODUCT DRAWING

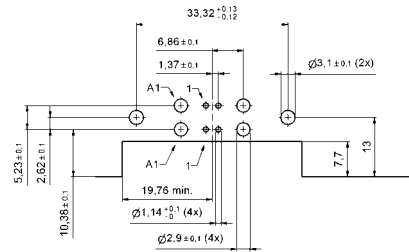
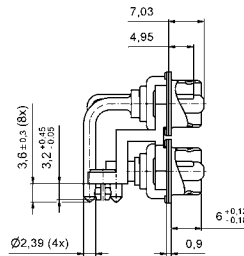
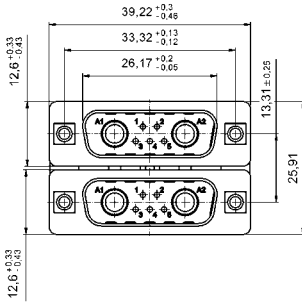

Mounting style:
Mounting bracket with PCB clip,
4-40 UNC threaded insert

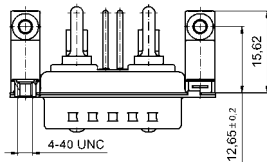

Mounting style:
Mounting bracket with PCB clip,
threaded insert and 4-40 UNC hex bolt

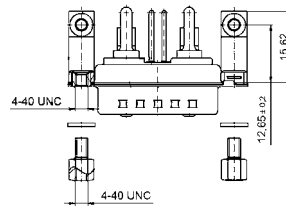

ORDER DATA

(Dim. = mm)

Version	PLUG CONNECTOR Mounting style	Part number
7W2	Mounting bracket with PCB clip/ Threaded insert and 4-40 UNC Hex bolt	13-000011
7W2	Mounting bracket with PCB clip/ 4-40 UNC Threaded insert	13-000021

PCB clip 3.1 mm ± 0.10 mm hole diameter and 1.6 mm circuit board thickness

POWER MODUL INPUT CONNECTORS

Plug connector – solder pin – angled – precision machined contacts – through hole solder type

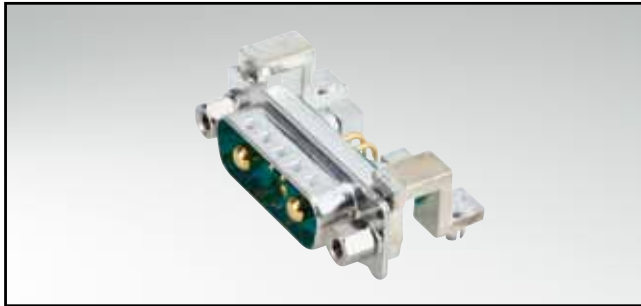

RoHS compliant

DESCRIPTION

- Design 7W2 for -48/-60 V power modul
- 2 power contacts 24 A / 2 signal contacts
- Single port version for MicroTCA PCB layout
- Mounting styles:
 - Mounting bracket with PCB clip, 4-40 UNC threaded insert
 - Mounting bracket with PCB clip, 4-40 UNC hex bolt
- Note for 9W4 product please contact factory

PRODUCT DRAWING

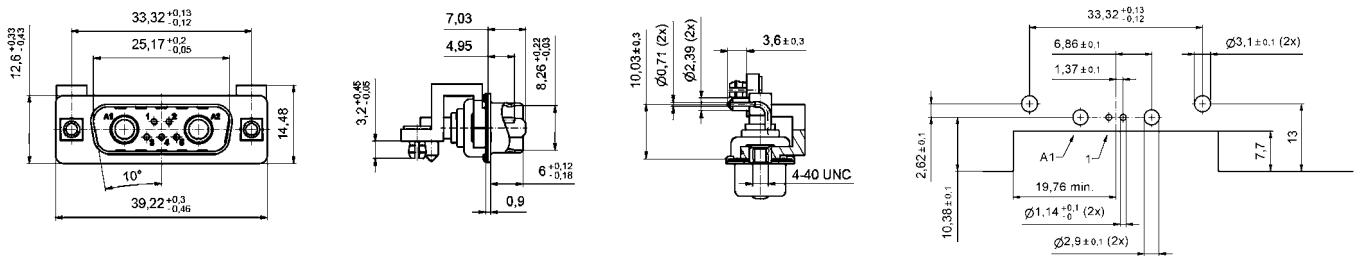

Mounting style:
Mounting bracket with PCB clip,
4-40 UNC threaded insert

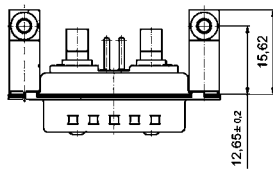

Mounting style:
Mounting bracket with PCB clip,
threaded insert and 4-40 UNC hex bolt

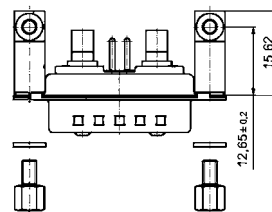

ORDER DATA

(Dim. = mm)

Version	PLUG CONNECTOR Mounting style	Part number
7W2	Mounting bracket with PCB clip/Threaded insert and 4-40 UNC Hex bolt	13-000051
7W2	Mounting bracket with PCB clip/4-40 UNC Threaded insert	13-000061

PCB clip 3.1 mm ± 0.10 mm hole diameter and 1.6 mm circuit board thickness

POWER INPUT CONNECTOR

Socket connector – solder cup or crimp body



RoHS compliant

DESCRIPTION

- 7W2 MicroTCA Design: 2 power / 2 signal contacts
- Available with bridged and unbridged signal contacts
- Mounting style: with through-hole 3.0 mm
- Power contacts solder cup or crimp type wire size
- Note for 9W4 product please contact factory

PRODUCT DRAWING

Solder cup

AWG	X	Current Rating
10-12	3.5	max. 30 A
12-14	2.7	max. 20 A
16-20	1.8	max. 10 A

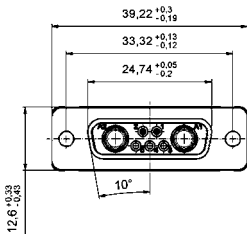

Crimp version

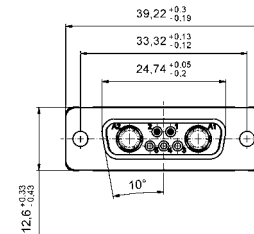

with signal contacts

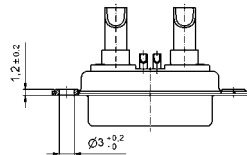

without signal contacts

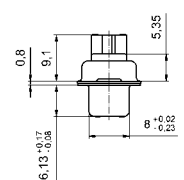
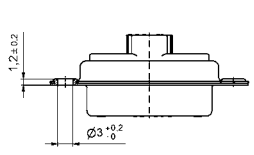

with bridged signal contacts

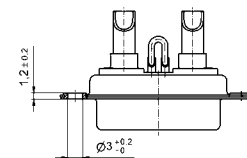

with bridged signal contacts

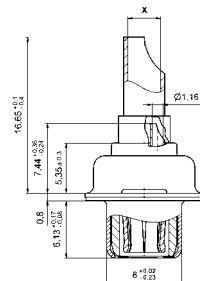
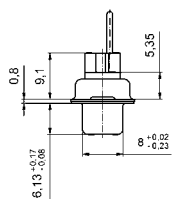
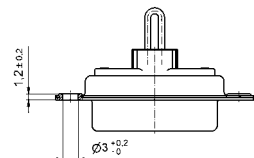

ORDER DATA

(Dim. = mm)

SOCKET CONNECTOR VERSION SOLDER CUP					
Version	Wire size	Current rating	Mounting style	Signal contacts	Part number
7W2	AWG 10 to 12	30 A	Through-hole 3.0 mm	unbridged	13-000131
7W2	AWG 12 to 14	20 A	Through-hole 3.0 mm	unbridged	13-000141
7W2	AWG 16 to 20	10 A	Through-hole 3.0 mm	unbridged	13-000151
7W2	AWG 10 to 12	30 A	Through-hole 3.0 mm	bridged	13-000161
7W2	AWG 12 to 14	20 A	Through-hole 3.0 mm	bridged	13-000171
7W2	AWG 16 to 20	10 A	Through-hole 3.0 mm	bridged	13-000181

SOCKET CONNECTOR CRIMP BODY				
Version	Design	Mounting style	Crimp signal contacts	Part number
7W2	Crimp body	Through-hole 3.0 mm	without	13-000190
7W2	Crimp body	Through-hole 3.0 mm	bridged	13-000201

POWER INPUT CONTACTS

Socket contact – crimp body – precision machined

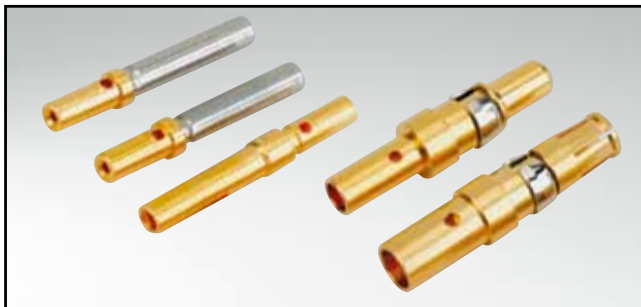

RoHS compliant

DESCRIPTION

- Precision machined contacts
- Quality class 1, standard
- Other quality classes on request

PRODUCT DRAWING

Signal Crimp contact (standard version)

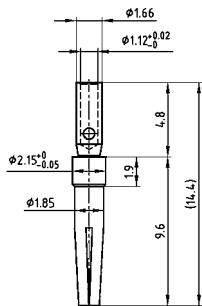

Signal Crimp contact (closed entry version)

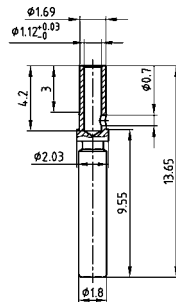

Power Crimp contact (standard version)

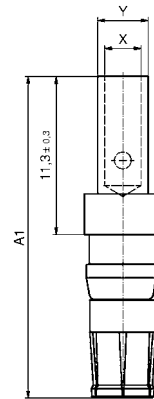

Power Crimp contact (short version)

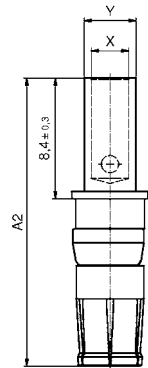

AWG	A ₁	A ₂	X	Y	Current rating
8 to 10		20.08	4.6	5.35	40 A
10 to 12	22.98	20.08	3.7	4.7	30 A
12 to 14	22.98	20.08	2.6	3.6	20 A
16 to 20	22.98	20.08	1.7	2.6	10 A

(Dim. = mm)

ORDER DATA

SOCKET CONNECTOR			
Contact	Wire cross section	Current rating	Part number
Signal crimp (standard version)	AWG 20 to 24	7,5 A	162 C 18709 X
Power crimp (standard version)	AWG 10 to 12 / A = 22.98	30 A	132 C 11039 X
Power crimp (standard version)	AWG 12 to 14 / A = 22.98	20 A	132 C 11029 X
Power crimp (standard version)	AWG 16 to 20 / A = 22.98	10 A	132 C 11019 X
Signal crimp (closed entry version)	AWG 20 to 24	7,5 A (Preferred type)	132 C 15019 X
Power crimp (for MicroTCA) (short version)	AWG 8 to 10 / A = 20.08	40 A	13-000321
Power crimp (for MicroTCA) (short version)	AWG 10 to 12 / A = 20.08	30 A	13-000311
Power crimp (for MicroTCA) (short version)	AWG 12 to 14 / A = 20.08	20 A	13-000301
Power crimp (for MicroTCA) (short version)	AWG 16 to 20 / A = 20.08	10 A	13-000291

CABLE HOOD AND CONNECTOR SET

Plastic hood with crimp connector body – straight cable entry



RoHS compliant

DESCRIPTION

- Compact 7W2 shell inclusive Crimp Socket connector
- Available with bridged signal contacts
- Short 4-40 UNC screws with Phillips or Allen key
- Material Housing: PBT GF; UL 94 V0, black
- Integrated strain relief
- Power contacts for wire size AWG 8 to AWG 20
- Hood can be used only with a special connector

PRODUCT DRAWING

Hood with short screw
(Socket connector included)

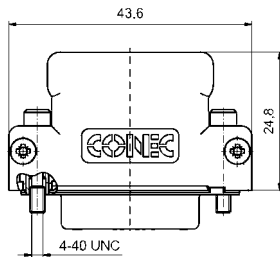
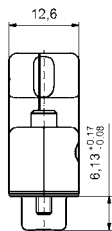
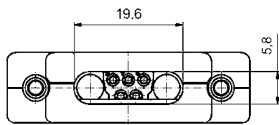
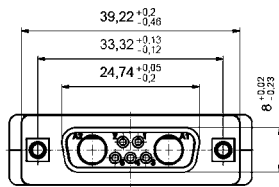

Hood with jack screw
(Socket connector included)

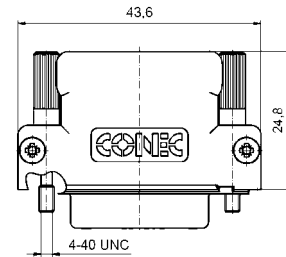
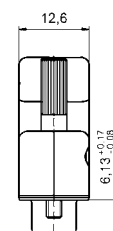
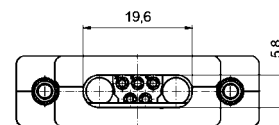
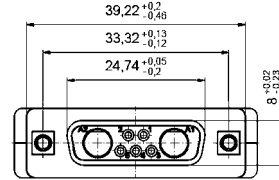

ORDER DATA

(Dim. = mm)

Version	SOCKET CONNECTOR			Part number
	Signal contacts	Screw design		
Hood/Crimp Socket connector 7W2	without	Short/Allen key		13-000210
Hood/Crimp Socket connector 7W2	without	Short/Phillips head		13-000220
Hood/Crimp Socket connector 7W2	bridged	Short/Allen key		13-000231
Hood/Crimp Socket connector 7W2	bridged	Short/Phillips head		13-000241
Hood/Crimp Socket connector 7W2	without	Jack screw/Allen key		13-000370
Hood/Crimp Socket connector 7W2	without	Jack screw/Phillips head		13-000380
Hood/Crimp Socket connector 7W2	bridged	Jack screw/Allen key		13-000391
Hood/Crimp Socket connector 7W2	bridged	Jack screw/Phillips head		13-000401

CABLE HOOD

Metal design – side cable entry



RoHS compliant

DESCRIPTION

- Cable hood for 7W2 MicroTCA Standard Socket connector
- Suitable for other D-SUB Connectors
- Material: Zink die-cast
- Fastening with 4-40 UNC thread and jack screws
- Solide zink die-cast strain relief
- Plastic cable run integrated in shell

PRODUCT DRAWING

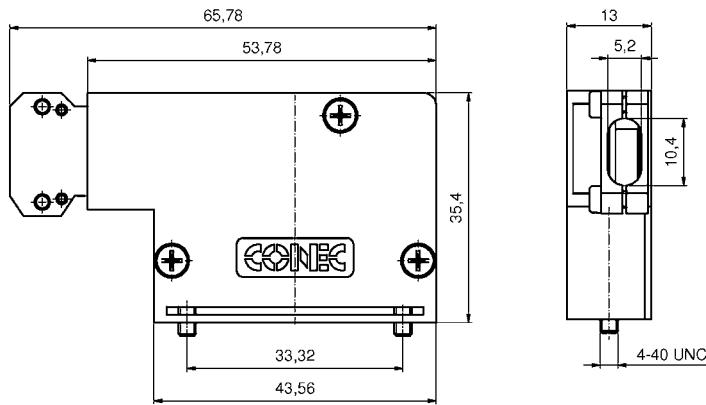

ORDER DATA

(Dim. = mm)

Version	Design	Part number
7W2	Metal hood	16-000010

SECTION 3

COMPACTPCI CONNECTORS



CONEC is a member of the PICMG Group and has developed the 47 positions power connector types, adhering to the specifications outlined in PICMG 2.11 R1.0.

Telecom, datacom, computer, medical, instrumentation and industrial control manufacturers are implementing the Compact PCI Bus structure. 'PCI' as it is known today stands for: Peripheral Component Interconnect.

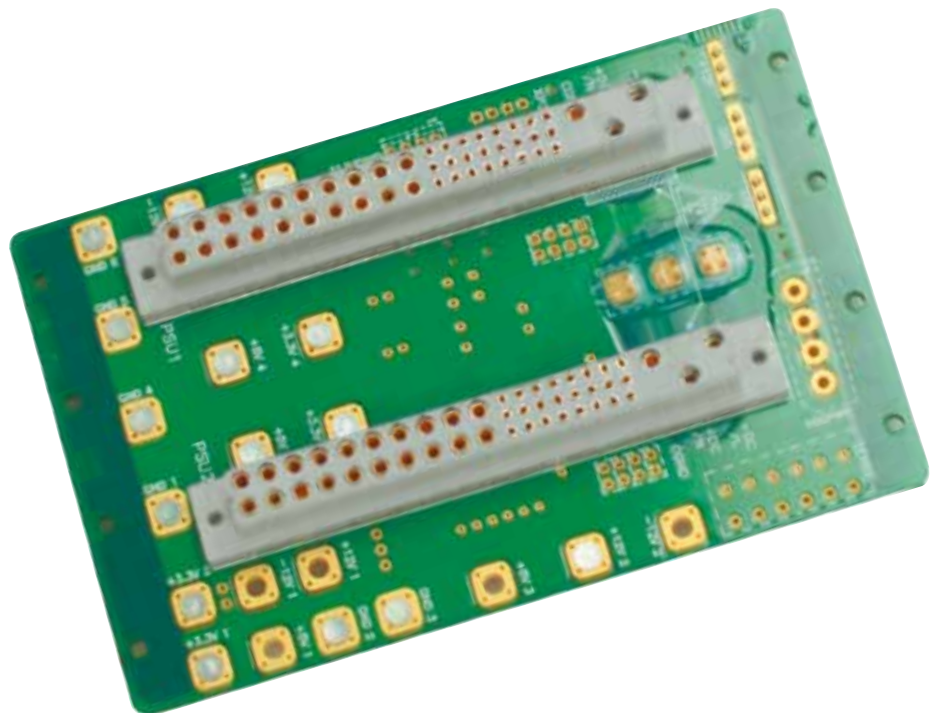

**Product features:**

- Male and female connectors
- Through hole and press fit types
- Precision machined contacts/stamped contacts
- Stamped flexible press fit design
- Selective assembly on request
- Premating and Sequential mating
- Mounting screws for PCB are available

CompactPCI[®]



TECHNICAL DATA

Materials	
Insulator	Glass filled plastic, UL 94V-0
Contacts	
Materials	Copper alloy
Plating for precision machined contacts	Gold flash over nickel/0,8 µm gold over nickel (press fit design tin over nickel)
Plating for stamped and formed contacts	Gold flash over nickel/selective 0,8 µm gold over nickel
Electrical Characteristics	
Contact Current Ratings, per UL 1977, (see temperature rise curve for details)	
CompactPCI 38 positions	
Size 16 Power Contacts:	
Positions 36, 37 and 38	40 A continuous, all contacts under load
Positions 1 to 20	28 A continuous, all contacts under load
Size 20 Signal Contacts	5 A nominal rating
CompactPCI 47 positions	
Size 16 power contacts:	
Positions 45, 46 and 47	40 A continuous, all contacts under load
Positions 1 to 20	28 A continuous, all contacts under load
Size 22 signal contacts	3 A nominal rating
Initial contact resistance (termination to termination)	
Size 16 power contacts	0.0007 Ω maximum
Size 20 signal contacts	0.004 Ω maximum
Size 22 signal contacts	0.004 Ω maximum
Insulation Resistance	5 G Ω per IEC 512-2 Test 3a method A
Voltage Proof	
CompactPCI 38 positions	
Contacts 36, 37 and 38	3000 V r.m.s.
Contacts 1 to 20	1500 V r.m.s.
Contacts 21 to 35	1000 V r.m.s.
CompactPCI 47 positions	
Size 16 power contacts:	
Contacts 45, 46 and 47	3000 V r.m.s.
Contacts 1 to 20	1500 V r.m.s.
Contacts 21 to 44	1000 V r.m.s.
Creepage and clearance distance (minimum)	
CompactPCI 38 positions	
Contact 38 to 36	3.2 mm
Contact 37 to contact 36	3.2 mm
Contact 38 to signal contacts	6.4 mm
Contact 37 to signal contacts	6.4 mm
Contact 38 to contact 37	2.5 mm
Contact 36 to signal contacts	2.0 mm
CompactPCI 47 positions	
Contact 47 to contact 45	3.2 mm
Contact 46 to contact 45	3.2 mm
Contact 47 to signal contacts	6.4 mm
Contact 46 to signal contacts	6.4 mm
Contact 47 to contact 46	2.5 mm
Contact 45 to signal contacts	2.0 mm

TECHNICAL DATA

Working voltage	
CompactPCI 38 positions	
Contacts 36, 37 and 38	1000 V r.m.s.
Contacts 1 to 20	500 V r.m.s.
Contacts 21 to 35	333 V r.m.s.
CompactPCI 47 positions	
Contacts 45, 46 and 47	1000 V r.m.s.
Contacts 1 to 20	500 V r.m.s.
Contacts 21 to 44	333 V r.m.s.
Mechanical Characteristics	
Blind mating system	Male and female connector bodies provide "lead-in" for 1.3 mm diametral misalignment
Polarization	Provided by connector body design
Crimp contacts	Install contact from termination side; release from mating side
Removable contact retention in connector body	
Size 16 contacts	67 N
Fixed contact retention in connector body	
Size 16 contacts	45 N
Size 20 and 22 contacts	27 N
Resistance to solder heat	260°C for 10 seconds duration per IEC 512-6, Test 12e, 25-watt soldering iron for other application contact factory
Sequential contact mating system	
CompactPCI 38 positions	First mate contact 36 and last mate contact positions 22, 25, and 28
CompactPCI 47 positions	First mate contact 45 and last mate contact position 27
Safety requirements	Following size 16 contacts are recessed 5 mm below the face of the female insulator for safety requirements
CompactPCI 38 positions	Contact positions 37 and 38
CompactPCI 47 positions	Contact positions 46 and 47
Compliant terminations press fit	Size 16, 20 and 22 contacts are available with compliant press fit compliant contact terminations
Printed board and panel mounting	Mounting holes provided in connector body for both printed board and panel mouting self-tapping screws are available
Mechanical operations	250 cycles
Working temperature	-55°C to +125°C

Technical alterations are subjects to change without notice.

TECHNICAL DATA

Materials	
Insulator	Glass filled plastic, UL 94V-0
Contacts	
Materials	Copper alloy
Plating for precision machined contacts	Gold flash over nickel/0,8 µm gold over nickel (press fit termination tin over nickel)
Plating for stamped and formed contacts	Gold flash over nickel/selective 0,8 µm gold over nickel
Electrical Characteristics	
Contact Current Ratings, per UL 1977	
Mini Power 24 positions	
Size 16 power contacts:	
Positions 22, 23 and 24	45 A continuous, all contacts under load
Positions 1 to 6	35 A continuous, all contacts under load
Size 20 Signal Contacts	3 A nominal rating
Mini Power 26 positions	
Size 16 power contacts:	
Positions 22-26	34 A continuous, all contacts under load
Positions 1 to 6	34 A continuous, all contacts under load
Size 22 signal contacts	3 A nominal rating
Initial contact resistance (termination to termination)	
Size 16 power contacts	0.0007 Ω maximum
Size 20 signal contacts	0.004 Ω maximum
Size 22 signal contacts	0.004 Ω maximum
Insulation Resistance	5 G Ω per IEC 512-2 Test 3a
Voltage Proof	
Mini Power 24 positions	
Contacts 22, 23 and 24	3000 V r.m.s.
Contacts 1 to 6	1500 V r.m.s.
Contacts 2 to 21	1000 V r.m.s.
Mini Power 26 positions	
Size 16 power contacts:	
Contacts 1 to 6	1500 V r.m.s.
Contacts 7 to 21	1000 V r.m.s.
Creepage and clearance distance (minimum)	
Mini Power 24 positions	
Contact 24 to contact 22	3.2 mm
Contact 23 to contact 22	3.2 mm
Contact 24 to contact 23	2.5 mm
Contact 24 to signal contacts	6.4 mm
Contact 23 to signal contacts	6.4 mm
Contact 22 to signal contacts	2.0 mm
Mini Power 26 positions	
Contact 22 to signal contacts	2.0 mm

Technical alterations are subjects to change without notice.

TECHNICAL DATA

Working voltage	
Mini Power 24 positions	
Contacts 22, 23 and 24	1000 V r.m.s.
Contacts 1 to 6	500 V r.m.s.
Contacts 7 to 21	333 V r.m.s.
Mini Power 26 positions	
Contacts 1 to 6 and 22 to 26	500 V r.m.s.
Contacts 7 to 21	333 V r.m.s.

Mechanical Characteristics	
Blind mating system	Male and female connector bodies provide "lead-in" for 1.3 mm diametral misalignment
Polarization	Provided by connector body design
Resistance to solder heat	260°C for 10 seconds duration per IEC 512-6, Test 12e, 25-watt soldering iron for other application contact factory
Sequential contact mating system	
Mini Power 24 positions	First mate contact 22 and last mate contact position 7
Mini Power 26 positions	Last mate contact position 7
Safety requirements	Following size 16 contacts are recessed 5 mm below the face of the female insulator for safety requirements
Mini Power 24 positions	Contact positions 23 and 24
Compliant terminations press fit	Size 16 and 22 contacts are available with compliant contact terminations
Printed board and panel mounting	Mounting holes provided in connector body for both printed board and panel mouting self-tapping screws are available
Mechanical operations	250 cycles
Working temperature	-55°C to +125°C

Technical alterations are subjects to change without notice.

DIAGRAM

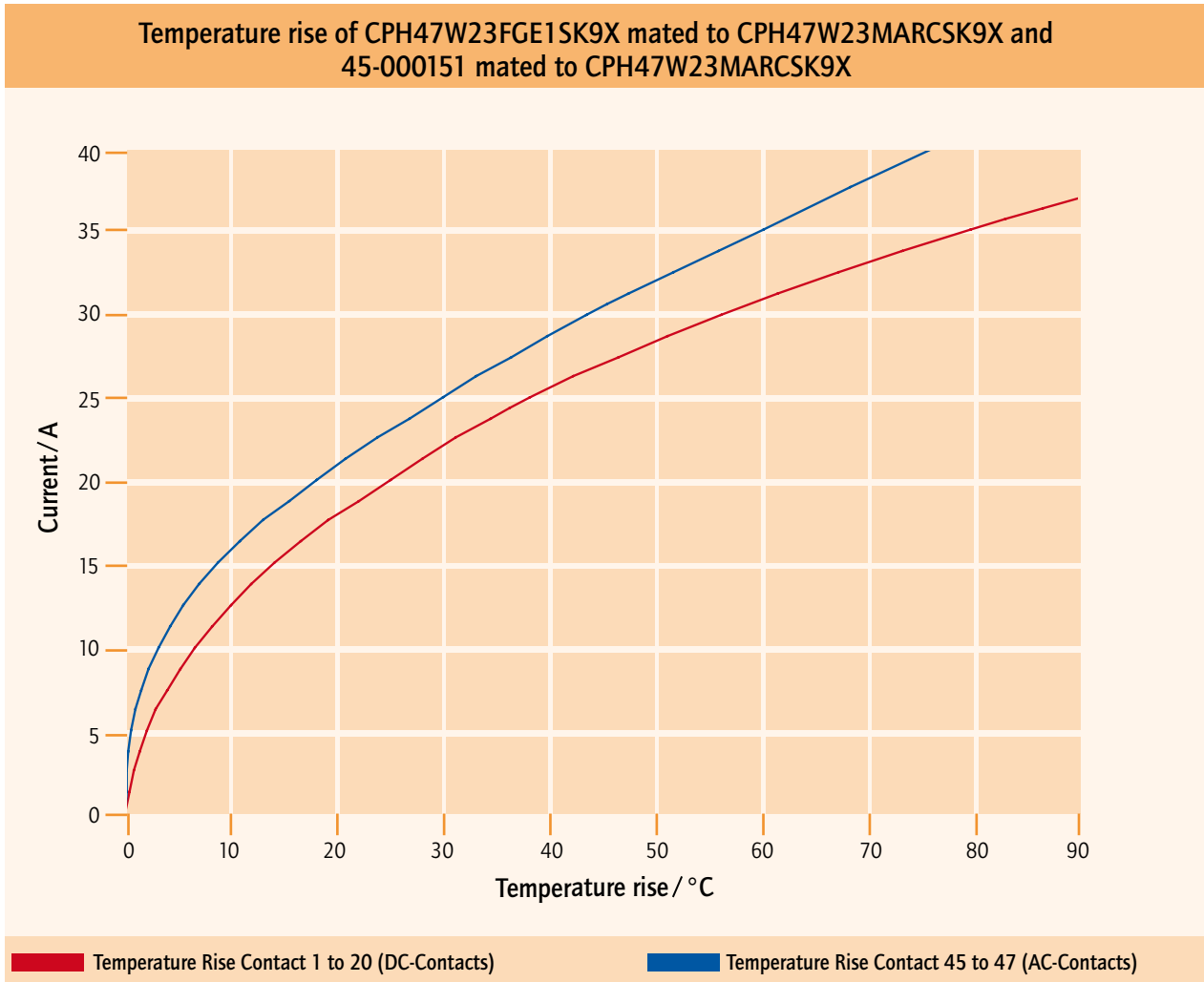

CONVERSION TABLE

μm 1/1000 mm	μinch 1/1000 inch	mm	inch	mm	inch	mm	inch	mm	inch	mm	inch
0,10	4	3,30	.130	10,16	.400	19,50	.768	30,90	1.217	49,50	1.949
0,20	8	3,40	.134	10,26	.402	19,70	.776	31,00	1.220	49,90	1.965
0,25	10	3,50	.138	10,36	.406	19,80	.780	31,20	1.228	50,10	1.972
0,30	12	3,60	.142	10,56	.413	19,90	.783	31,50	1.240	50,30	1.980
0,50	20	3,70	.146	10,66	.417	20,00	.787	31,70	1.248	50,50	1.988
0,70	28	3,80	.150	10,76	.421	20,10	.791	32,00	1.260	50,70	1.996
0,75	30	3,81	.150	11,00	.433	20,30	.799	32,20	1.268	50,80	2.000
0,80	32	3,90	.154	11,20	.441	20,32	.800	32,30	1.272	51,40	2.024
1,00	39	4,00	.158	11,40	.449	20,50	.807	32,50	1.280	51,50	2.028
1,27	50	4,10	.161	11,50	.453	21,00	.827	32,80	1.291	52,00	2.047
2,00	79	4,20	.165	11,60	.457	21,10	.831	33,00	1.299	52,30	2.059
2,50	98	4,30	.169	11,90	.469	21,70	.854	33,10	1.303	52,80	2.079
3,00	118	4,30	.169	11,90	.469	21,70	.854	33,10	1.303	52,80	2.079
4,00	157	4,50	.177	12,00	.472	22,00	.866	33,30	1.311	53,00	2.087
5,00	197	4,70	.185	12,20	.480	22,10	.870	33,80	1.331	53,20	2.095
		4,90	.193	12,30	.484	22,20	.874	34,00	1.339	53,80	2.118
mm	inch	5,00	.197	12,40	.488	22,30	.878	34,20	1.346	54,00	2.126
0,10	.004	5,08	.200	12,50	.492	22,40	.882	34,40	1.354	54,20	2.134
0,20	.008	5,10	.201	12,70	.500	22,50	.886	35,00	1.378	54,90	2.161
0,25	.012	5,20	.205	12,90	.508	22,60	.890	35,40	1.394	55,00	2.165
0,35	.014	5,30	.209	13,00	.512	22,80	.898	35,50	1.398	55,40	2.181
0,40	.016	5,40	.213	13,10	.516	22,86	.900	35,56	1.400	55,70	2.193
0,45	.018	5,50	.217	13,20	.520	22,90	.902	35,60	1.402	56,60	2.228
0,50	.020	5,60	.220	13,50	.532	23,00	.906	36,00	1.417	57,40	2.260
0,55	.022	5,70	.224	13,60	.535	23,10	.909	36,50	1.437	57,80	2.276
0,60	.024	5,80	.228	13,70	.539	23,30	.917	36,60	1.441	57,90	2.280
0,64	.025	6,00	.236	13,90	.547	23,50	.925	36,70	1.445	58,42	2.300
0,65	.026	6,10	.240	14,00	.551	24,00	.945	37,00	1.457	59,00	2.323
0,70	.028	6,40	.252	14,30	.563	24,30	.957	37,30	1.469	59,20	2.331
0,75	.030	6,50	.256	14,40	.567	24,60	.969	37,50	1.476	59,80	2.354
0,80	.032	6,60	.260	14,50	.571	24,90	.980	37,60	1.480	59,90	2.358
0,85	.034	6,70	.264	14,70	.579	25,00	.984	37,70	1.484	60,00	2.362
0,90	.035	6,80	.268	14,80	.583	25,10	.998	37,90	1.492	60,96	2.400
1,00	.039	6,90	.272	14,90	.587	25,40	1.000	38,00	1.496	61,10	2.406
1,20	.047	7,00	.276	14,98	.590	25,60	1.008	38,10	1.500	62,00	2.441
1,25	.049	7,10	.280	15,00	.591	25,90	1.020	39,00	1.535	63,00	2.480
1,27	.050	7,20	.283	15,20	.598	26,00	1.024	39,20	1.543	63,50	2.500
1,30	.051	7,40	.291	15,24	.600	26,30	1.035	39,30	1.547	64,00	2.520
1,35	.053	7,50	.295	15,40	.606	26,60	1.047	39,90	1.571	65,00	2.560
1,40	.055	7,60	.299	15,50	.610	26,70	1.051	40,00	1.575	67,00	2.638
1,45	.057	7,62	.300	15,60	.614	27,00	1.063	40,30	1.587	68,00	2.677
1,50	.059	7,70	.303	15,90	.626	27,20	1.071	40,40	1.591	69,00	2.717
1,60	.063	7,80	.307	16,00	.630	27,40	1.079	40,60	1.598	70,00	2.756
1,70	.067	7,98	.314	16,20	.638	27,50	1.093	41,00	1.614	71,00	2.795
1,80	.071	8,00	.315	16,50	.650	27,90	1.098	41,60	1.638	74,00	2.913
1,85	.073	8,18	.318	16,60	.654	27,94	1.100	42,70	1.681	75,00	2.953
1,90	.075	8,20	.323	16,80	.661	28,00	1.102	43,18	1.700	76,20	3.000
2,00	.079	8,30	.327	17,00	.669	28,20	1.110	44,20	1.740	77,00	3.032
2,10	.083	8,40	.331	17,20	.677	28,50	1.122	44,80	1.764	78,74	3.100
2,20	.087	8,50	.335	17,30	.681	28,70	1.130	45,80	1.803	80,00	3.150
2,30	.091	8,60	.339	17,50	.689	29,00	1.142	46,30	1.823	81,28	3.200
2,40	.095	8,90	.350	17,60	.693	29,20	1.150	46,70	1.839	84,00	3.307
2,50	.098	9,00	.354	17,70	.697	29,40	1.158	47,00	1.850	85,00	3.346
2,54	.100	9,10	.358	17,78	.700	29,50	1.161	47,20	1.858	86,36	3.400
2,60	.102	9,20	.362	17,80	.701	29,70	1.169	47,30	1.862	88,90	3.500
2,70	.106	9,30	.366	17,90	.705	29,90	1.177	47,50	1.870	90,00	3.543
2,80	.110	9,40	.370	18,00	.709	30,00	1.181	47,80	1.882	91,44	3.600
2,84	.112	9,50	.374	18,10	.713	30,20	1.189	48,00	1.890	94,00	3.701
2,90	.114	9,60	.378	18,30	.721	30,40	1.197	48,10	1.894	95,00	3.740
3,00	.118	9,70	.382	18,60	.732	30,48	1.200	48,26	1.900	100,00	3.937
3,10	.122	9,90	.390	19,00	.748	30,50	1.201	48,80	1.921	110,00	4.331
3,20	.126	10,00	.395	19,20	.756	30,80	1.213	49,10	1.933	120,00	4.724

COMPACTPCI

Male connector – solder pin – angled – precision machined contacts – 38 positions



RoHS compliant – UL listed, File no.: E228329

DESCRIPTION

- Signal and power contacts
- 38 contacts, 15x signal / 23x power
- Sequential mating
- Contact plating quality class 1 or alternative quality class 3
- Special contact loadings possible on request

PRODUCT DRAWING

PCB-hole pattern

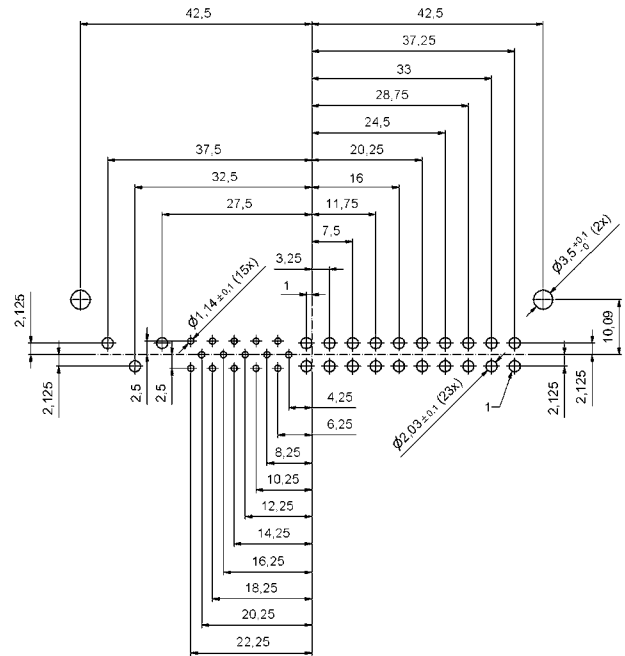
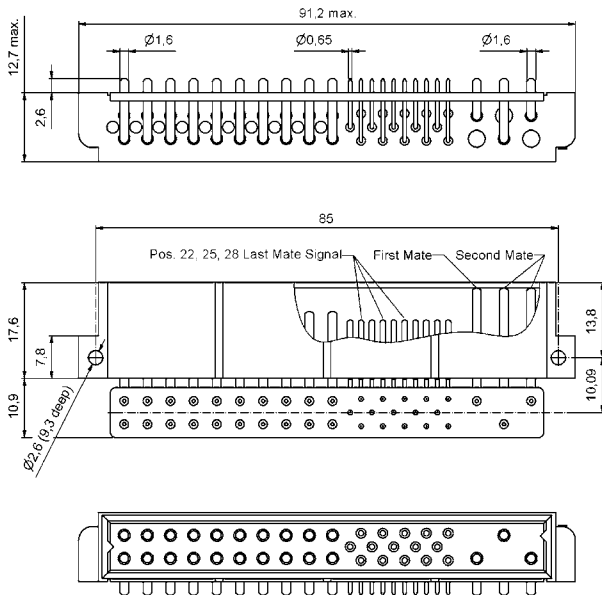

ORDER DATA

(Dim. = mm)

Number of positions	Contacts	Part number Quality class 3 (gold flash)	Part number Quality class 1 (0.8µm Au mating area)
38	15x signal / 23x power	CPH38 W23 MARASK9 X	CPH38 W23 MARCSK9 X

COMPACTPCI

Male connector – solder pin – angled – precision machined contacts – 38 positions

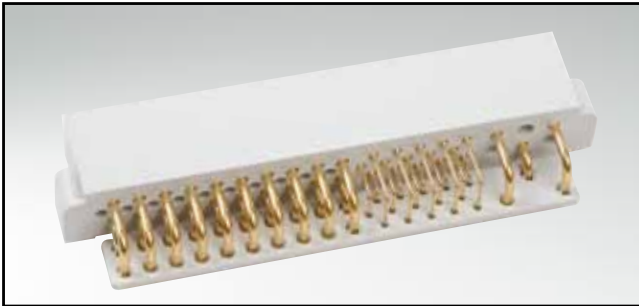

RoHS compliant – UL listed, File no.: E228329

DESCRIPTION

- Signal and power contacts
- 38 contacts, 15x signal / 23x power
- Sequential mating
- Contact plating quality class 1 or alternative quality class 3
- **Inverted version**
- Special contact loadings possible on request

PRODUCT DRAWING

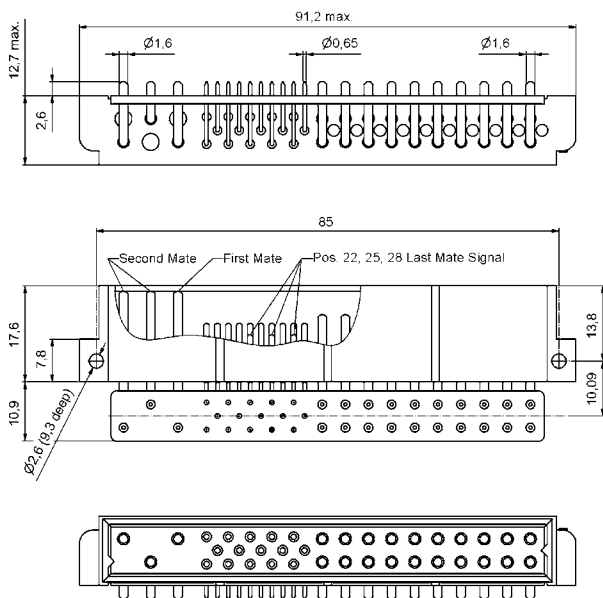

PCB-hole pattern

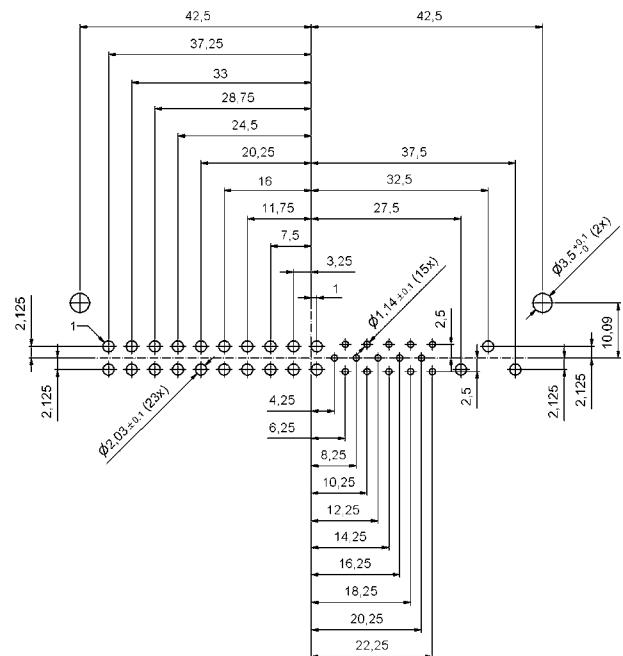

ORDER DATA

(Dim. = mm)

Number of positions	Contacts	Part number Quality class 3 (gold flash)	Part number Quality class 1 (0.8µm Au mating area)
38	15x signal / 23x power	CPH38 W23 MARARK9 X	CPH38 W23 MARCRK9 X

COMPACTPCI

Male connector – solder pin – angled – precision machined contacts – 47 positions



RoHS compliant – UL listed, File no.: E228329

DESCRIPTION

- Signal and power contacts
- 47 contacts, 24x signal / 23x power
- Sequential mating
- Contact plating quality class 1 or alternative quality class 3
- Special contact loadings possible on request

PRODUCT DRAWING

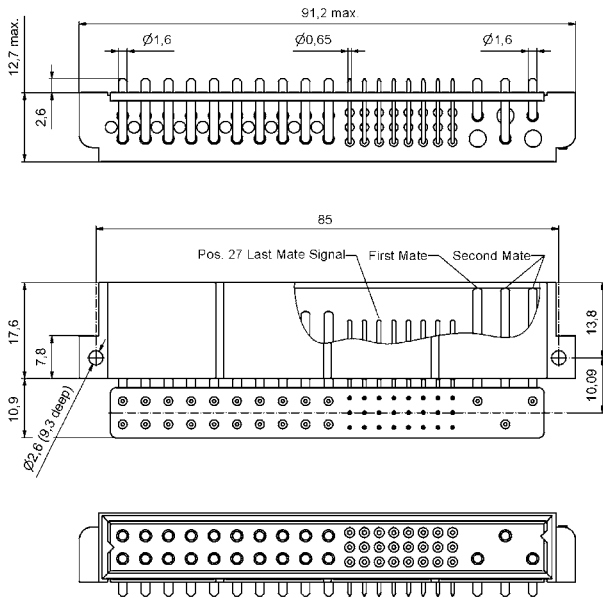

PCB-hole pattern

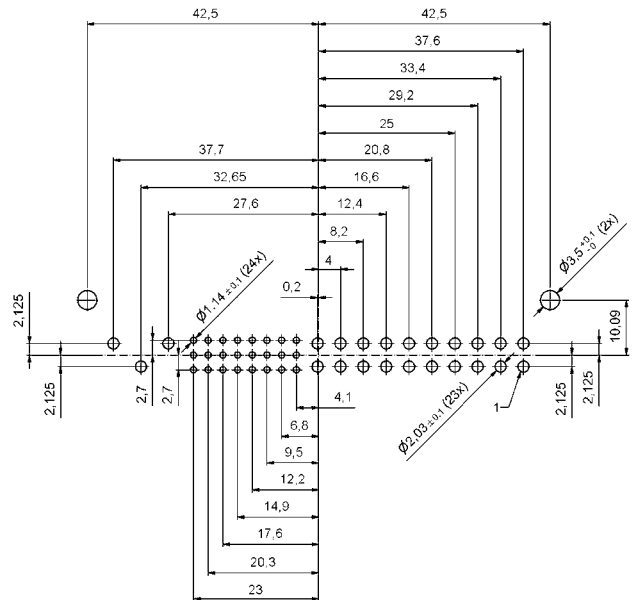

ORDER DATA

(Dim. = mm)

Number of positions	Contacts	Part number Quality class 3 (gold flash)	Part number Quality class 1 (0.8µm Au mating area)
47	24x signal / 23x power	CPH47 W23 MARASK9 X	CPH47 W23 MARCSK9 X

COMPACTPCI

Female connector – solder pin – angled – precision machined contacts – 38 positions

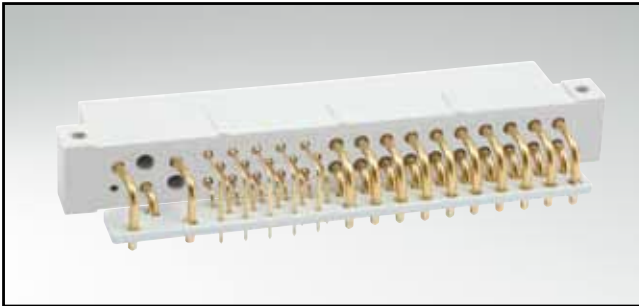

RoHS compliant – UL listed, File no.: E228329

DESCRIPTION

- Signal and power contacts
- 38 contacts, 15x signal / 23x power
- Sequential mating
- Contact plating quality class 1 or alternative quality class 3
- **Inverted version**
- Special contact loadings possible on request

PRODUCT DRAWING

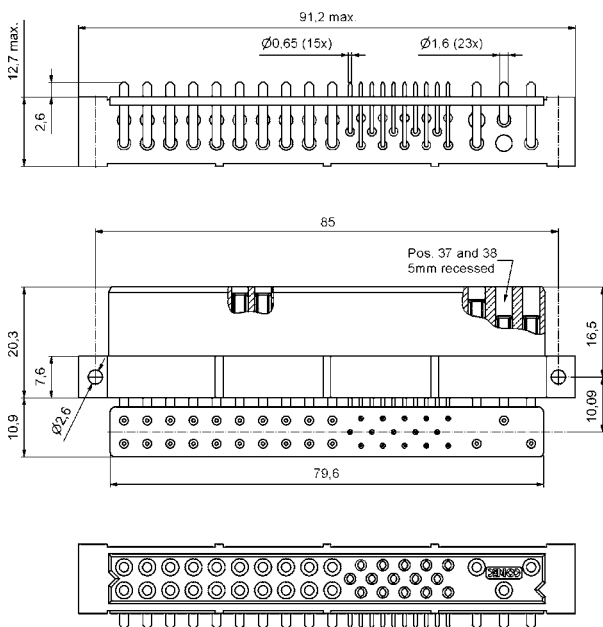

PCB-hole pattern

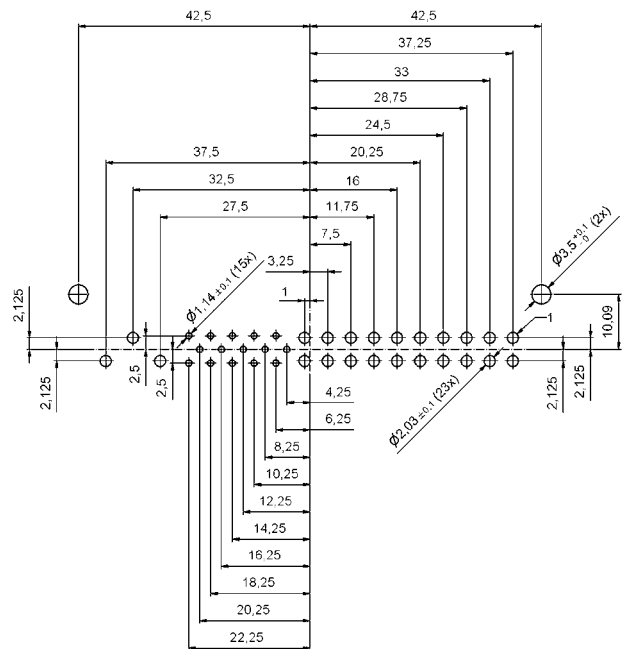

ORDER DATA

(Dim. = mm)

Number of positions	Contacts	Part number Quality class 3 (gold flash)	Part number Quality class 1 (0.8 μ m Au mating area)
38	15x signal / 23x power	CPH38 W23 FARARK9 X	CPH38 W23 FARCRK9 X

COMPACTPCI

Female connector – angled – precision machined contacts – 47 positions

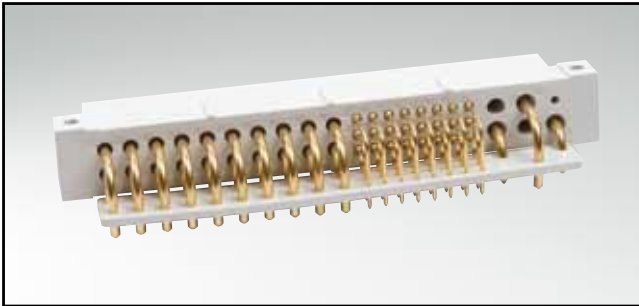

RoHS compliant – UL listed, File no.: E228329

DESCRIPTION

- Signal and power contacts
- 47 contacts, 24x signal / 23x power
- Sequential mating
- Contact plating quality class 1 or alternative quality class 3
- Special contact loadings possible on request

PRODUCT DRAWING

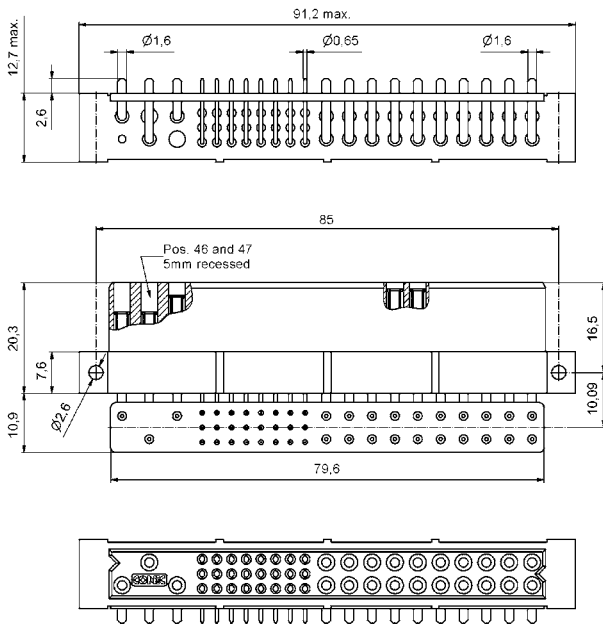

PCB-hole pattern

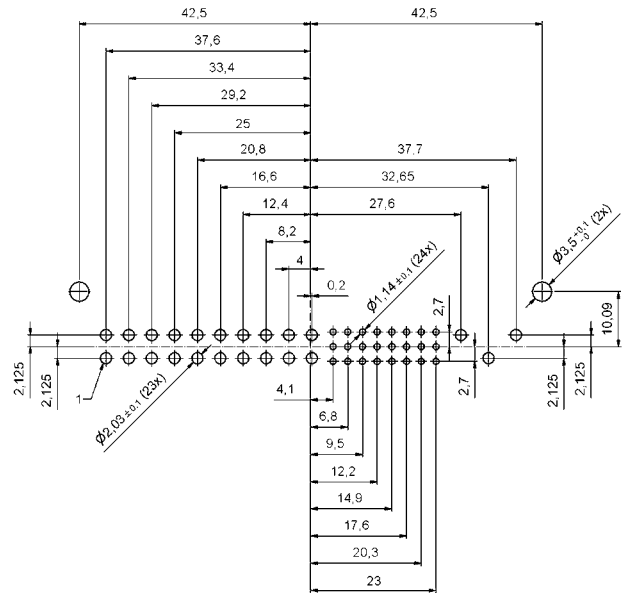

ORDER DATA

(Dim. = mm)

Number of positions	Contacts	Part number Quality class 3 (gold flash)	Part number Quality class 1 (0.8µm Au mating area)
47	24x signal / 23x power	CPH47 W23 FARASK9 X	CPH47 W23 FARCSK9 X

COMPACTPCI

Female connector – angled – precision machined contacts – 47 positions

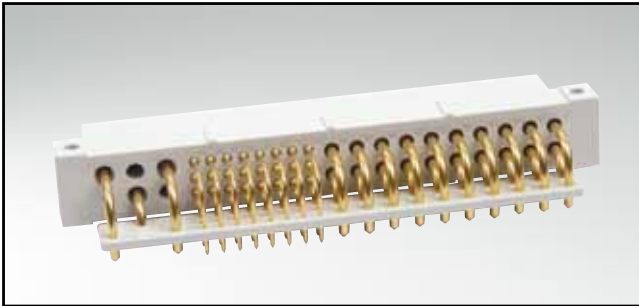

RoHS compliant – UL listed, File no.: E228329

DESCRIPTION

- Signal and power contacts
- 47 contacts, 24x signal / 23x power
- Sequential mating
- Contact plating quality class 1 or alternative quality class 3
- **Inverted version**
- Special contact loadings possible on request

PRODUCT DRAWING

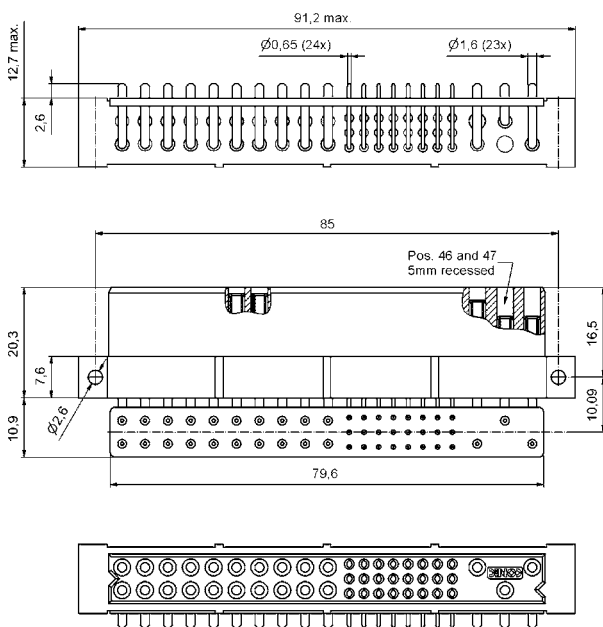

PCB-hole pattern

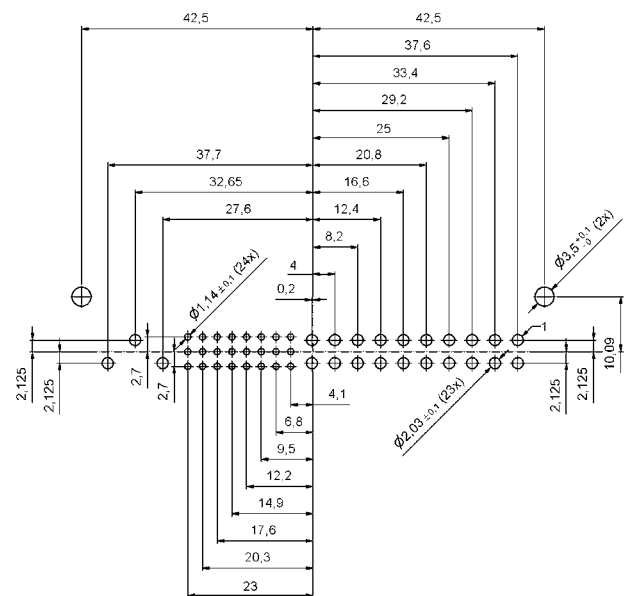

ORDER DATA

(Dim. = mm)

Number of positions	Contacts	Part number Quality class 3 (gold flash)	Part number Quality class 1 (0.8µm Au mating area)
47	24x signal / 23x power	CPH47 W23 FARARK9 X	CPH47 W23 FARCRK9 X

COMPACTPCI

Female connector – angled – precision machined contacts – 47 positions

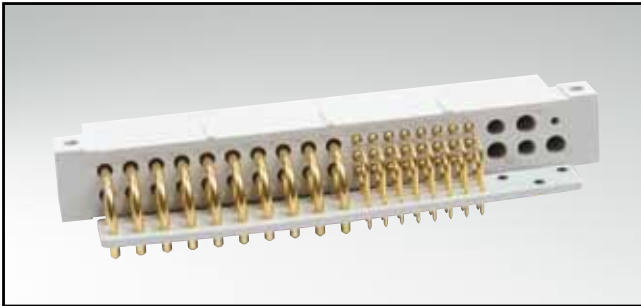

RoHS compliant – UL listed, File no.: E228329

DESCRIPTION

- Signal and power contacts
- Selectively loaded with 24x signal / 20x power
- Position 45 to 47 for crimp contacts (page 3 | 36)
- Contact plating quality class 1 or alternative quality class 3
- Special contact loadings possible on request

PRODUCT DRAWING

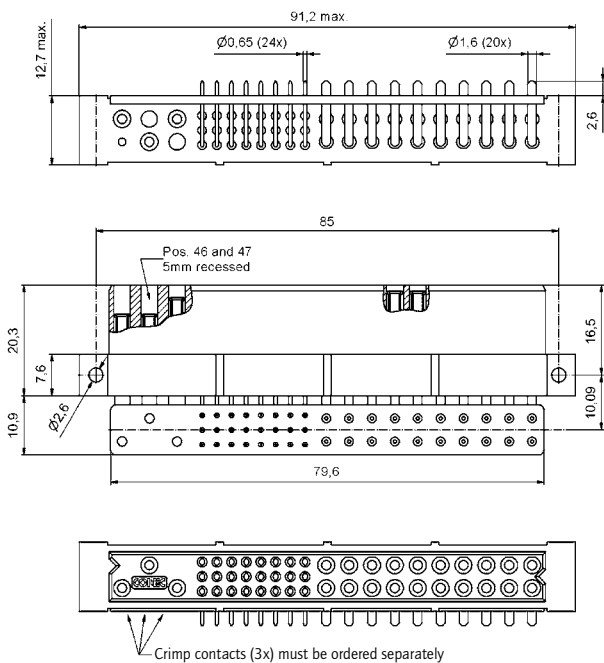

PCB-hole pattern

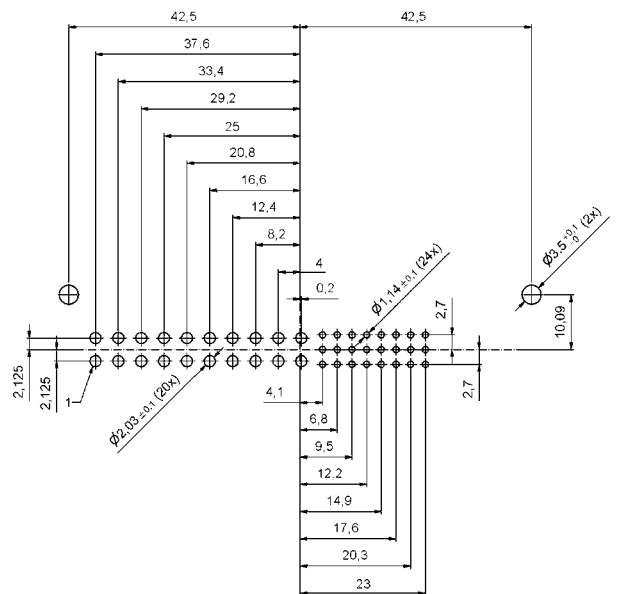

ORDER DATA

(Dim. = mm)

Number of positions	Contacts	Part number Quality class 3 (gold flash)	Part number Quality class 1 (0,8µm Au mating area)
47	24x signal / 20x power	CPH47 W23 FARASN9 X	CPH47 W23 FARCSN9 X

COMPACTPCI

Female connector – angled – precision machined contacts – 47 positions

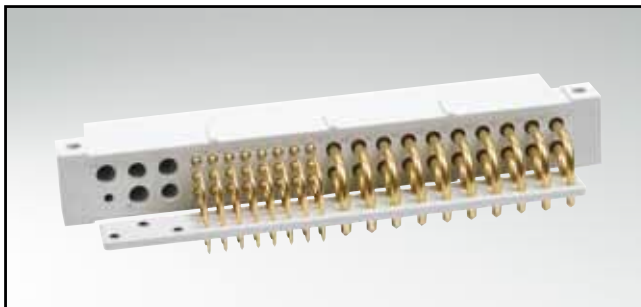

RoHS compliant – UL listed, File no.: E228329

DESCRIPTION

- Signal and power contacts
- Selectively loaded with 24x signal / 20x power
- Position 45 to 47 for crimp contacts (page 3 | 36)
- Contact plating quality class 1 or alternative quality class 3
- **Inverted version**
- Special contact loadings possible on request

PRODUCT DRAWING

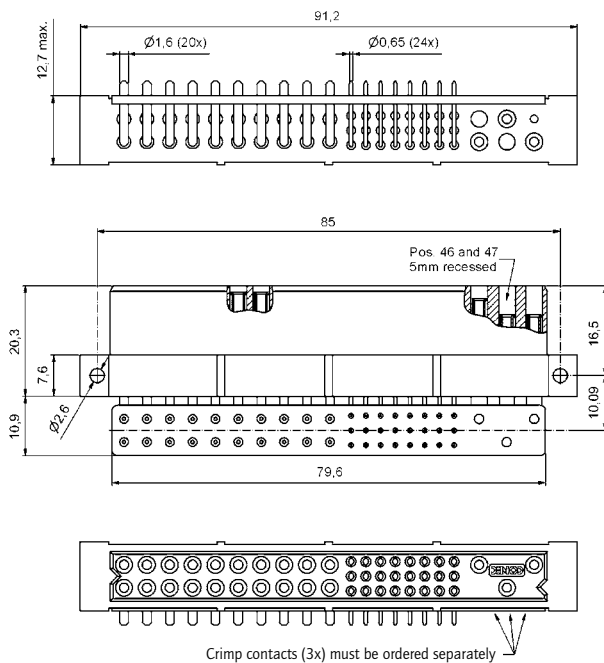

PCB-hole pattern

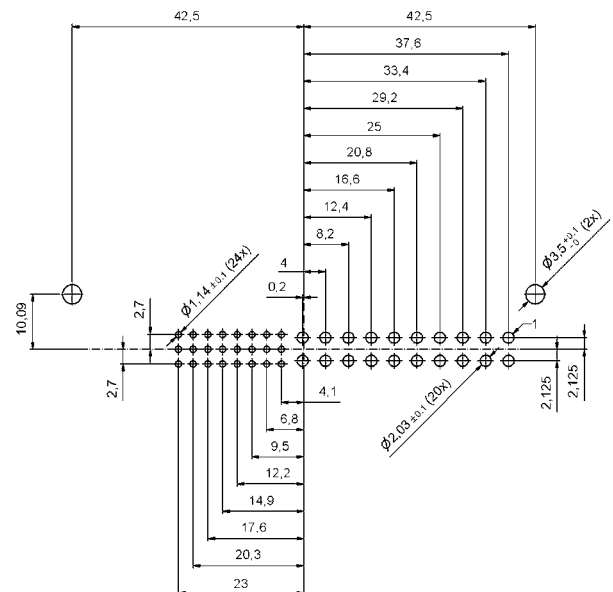

ORDER DATA

(Dim. = mm)

Number of positions	Contacts	Part number Quality class 3 (gold flash)	Part number Quality class 1 (0.8 μ m Au mating area)
47	24x signal / 20x power	CPH47 W23 FARARN9 X	CPH47 W23 FARCRN9 X

COMPACTPCI

Male connector – solder pin – straight – precision machined contacts – 38 positions

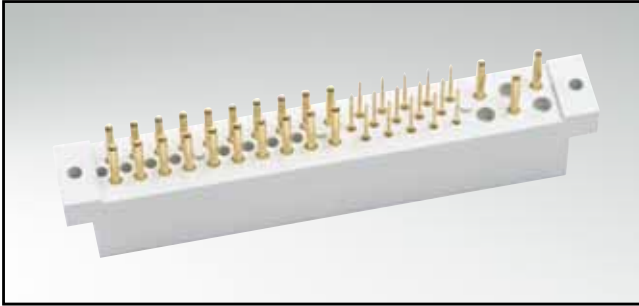

RoHS compliant – UL listed, File no.: E228329

DESCRIPTION

- Signal and power contacts
- 38 contacts, 15x signal / 23x power
- Sequential mating
- Contact plating quality class 1 or alternative quality class 3
- Special contact loadings possible on request

PRODUCT DRAWING

PCB-hole pattern

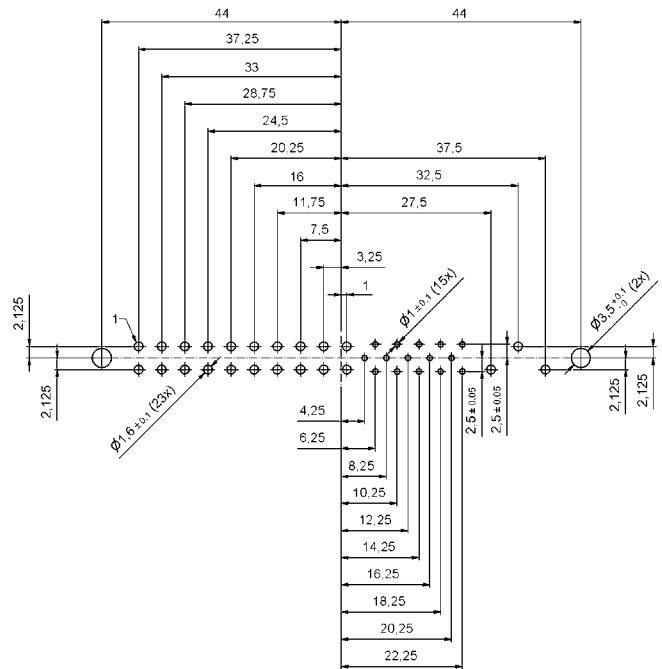
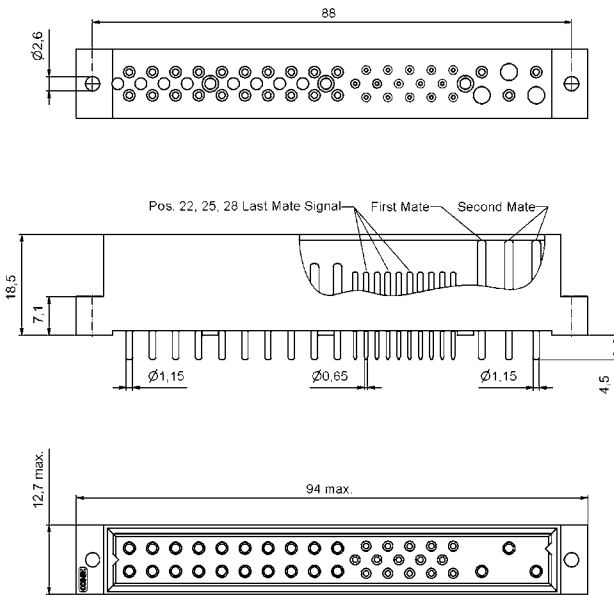

ORDER DATA

(Dim. = mm)

Number of positions	Contacts	Part number Quality class 3 (gold flash)	Part number Quality class 1 (0.8µm Au mating area)
38	15x signal / 23x power	CPH38 W23 MGRASK9 X	CPH38 W23 MGRCSK9 X

COMPACTPCI

Male connector – solder pin – straight – precision machined contacts – 47 positions

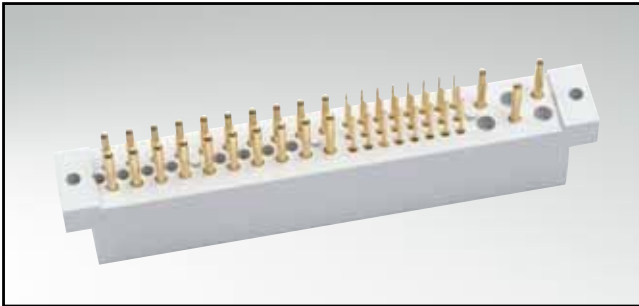

RoHS compliant – UL listed, File no.: E228329

DESCRIPTION

- Signal and power contacts
- 47 contacts, 24x signal / 23x power
- Sequential mating
- Contact plating quality class 1 or alternative quality class 3
- Special contact loadings possible on request

PRODUCT DRAWING

PCB-hole pattern

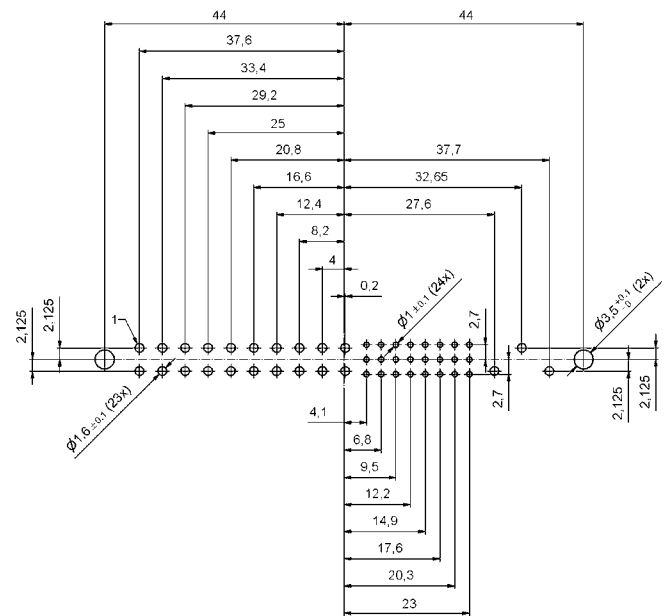
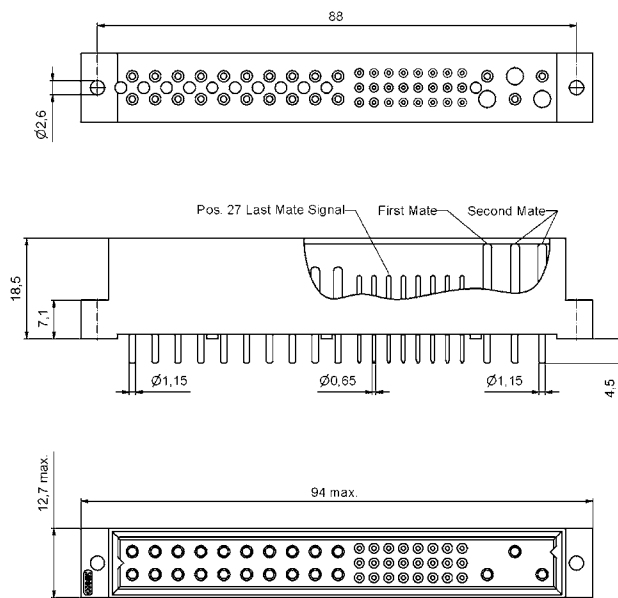

ORDER DATA

(Dim. = mm)

Number of positions	Contacts	Part number Quality class 3 (gold flash)	Part number Quality class 1 (0.8µm Au mating area)
47	24x signal / 23x power	CPH47 W23 MGRASK9 X	CPH47 W23 MGRCSK9 X

COMPACTPCI

Female connector – solder pin – straight – precision machined contacts – 38 positions

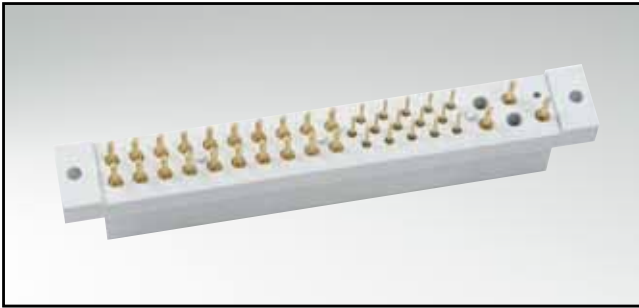

RoHS compliant – UL listed, File no.: E228329

DESCRIPTION

- Signal and power contacts
- 38 contacts, 15x signal / 23x power
- Sequential mating
- Contact plating quality class 1 or alternative quality class 3
- Special contact loadings possible on request

PRODUCT DRAWING

PCB-hole pattern

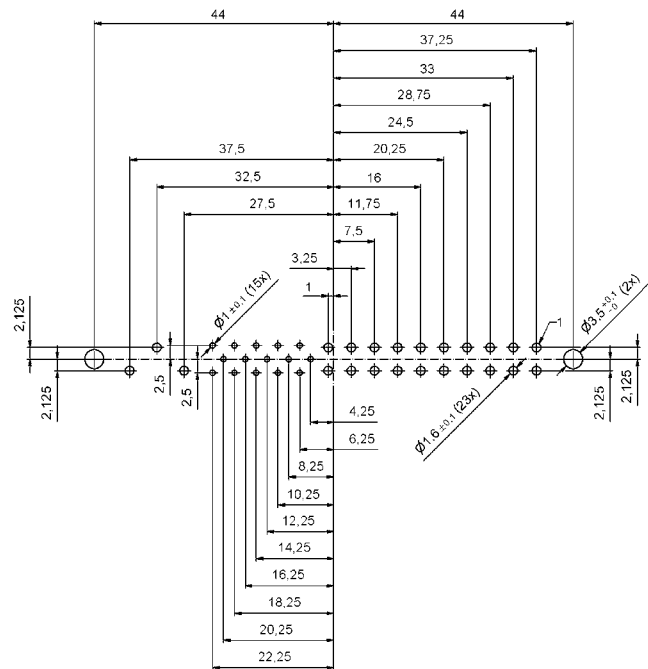
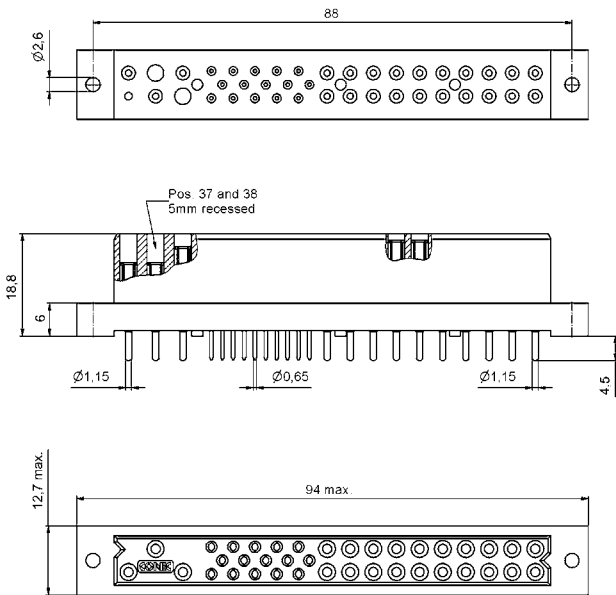

ORDER DATA

(Dim. = mm)

Number of positions	Contacts	Part number Quality class 3 (gold flash)	Part number Quality class 1 (0.8 μ m Au mating area)
38	15x signal / 23x power	CPH38 W23 FGRASK9 X	CPH38 W23 FGRCCK9 X

COMPACTPCI

Female connector – solder pin – straight – precision machined contacts – 38 positions

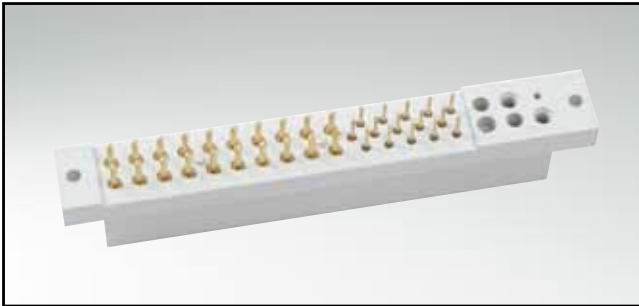

RoHS compliant – UL listed, File no.: E228329

DESCRIPTION

- Signal and power contacts
- Selectively loaded with 15x signal / 20x power
- Position 36 to 38 for crimp contacts (page 3 | 36)
- Contact plating quality class 1 or alternative quality class 3
- "Low Profile" area for crimp contacts
- Special contact loadings possible on request

PRODUCT DRAWING

PCB-hole pattern

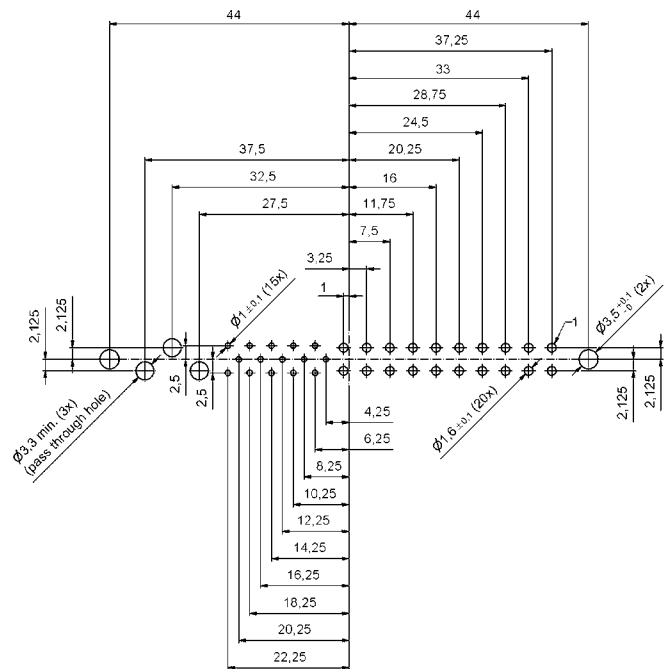
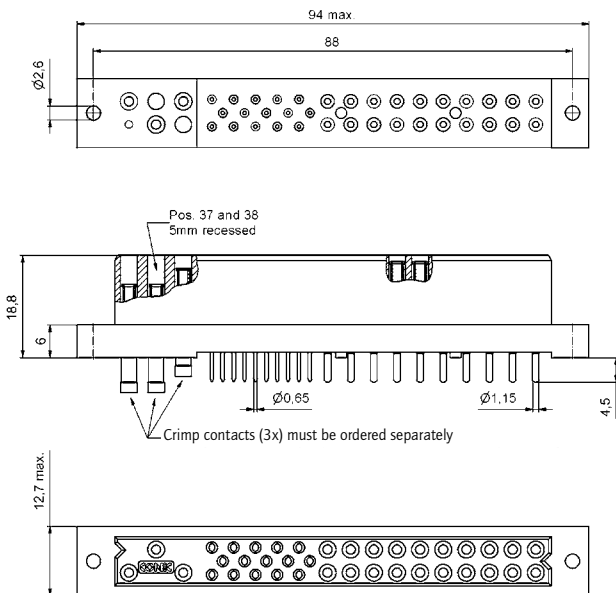

ORDER DATA

(Dim. = mm)

Number of positions	Contacts	Part number Quality class 3 (gold flash)	Part number Quality class 1 (0.8µm Au mating area)
38	15x signal / 20x power	CPH38 W23 FGRASN9 X	CPH38 W23 FGRCNS9 X

COMPACTPCI

Female connector – solder pin – straight – precision machined contacts – 38 positions

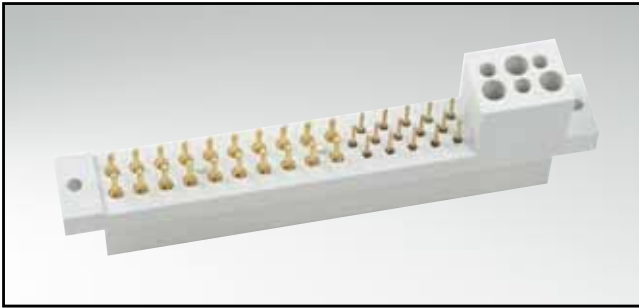

RoHS compliant – UL listed, File no.: E228329

DESCRIPTION

- Signal and power contacts
- Selectively loaded with 15x signal / 20x power
- Position 36 to 38 for crimp contacts (page 3 | 36)
- Contact plating quality class 1 or alternative quality class 3
- "High Profile", insulation support for crimp contacts
- Special contact loadings possible on request

PRODUCT DRAWING

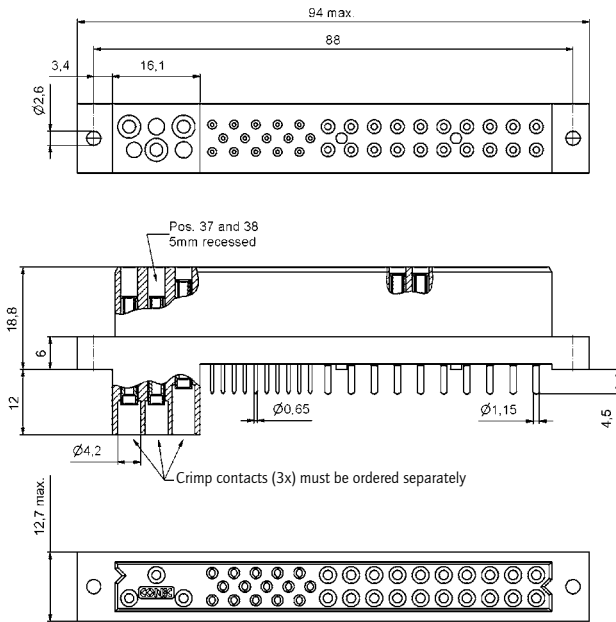

PCB-hole pattern

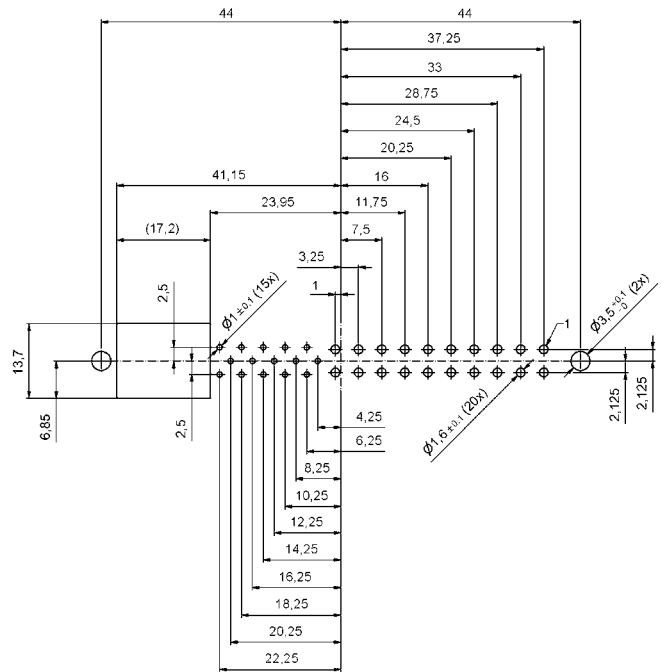

ORDER DATA

(Dim. = mm)

Number of positions	Contacts	Part number Quality class 3 (gold flash)	Part number Quality class 1 (0.8µm Au mating area)
38	15x signal / 20x power	CPH38 W23 FGRASH9 X	CPH38 W23 FGRC9H9 X

COMPACTPCI

Female connector – solder pin – straight – precision machined contacts – 47 positions

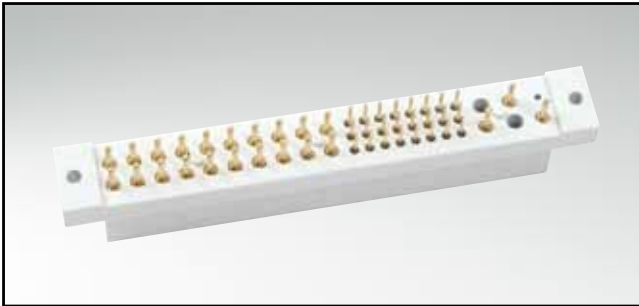

RoHS compliant – UL listed, File no.: E228329

DESCRIPTION

- Signal and power contacts
- 47 contacts, 24x signal / 23x power
- Sequential mating
- Contact plating quality class 1 or alternative quality class 3
- Special contact loadings possible on request

PRODUCT DRAWING

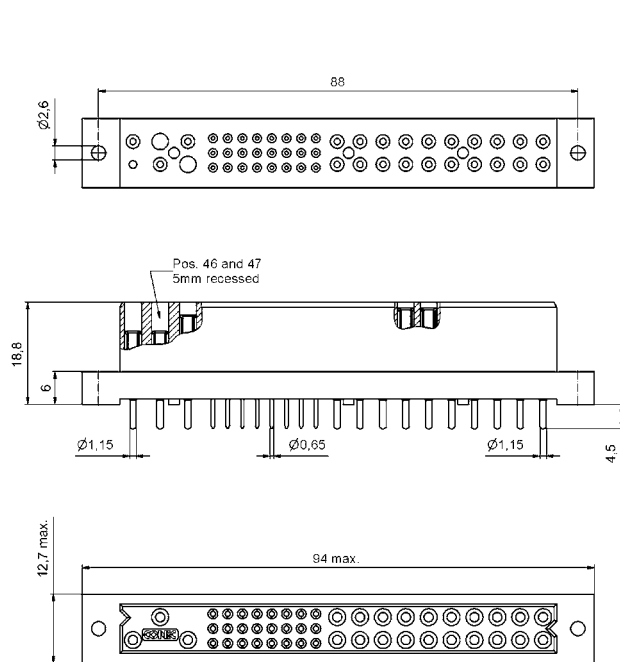

PCB-hole pattern

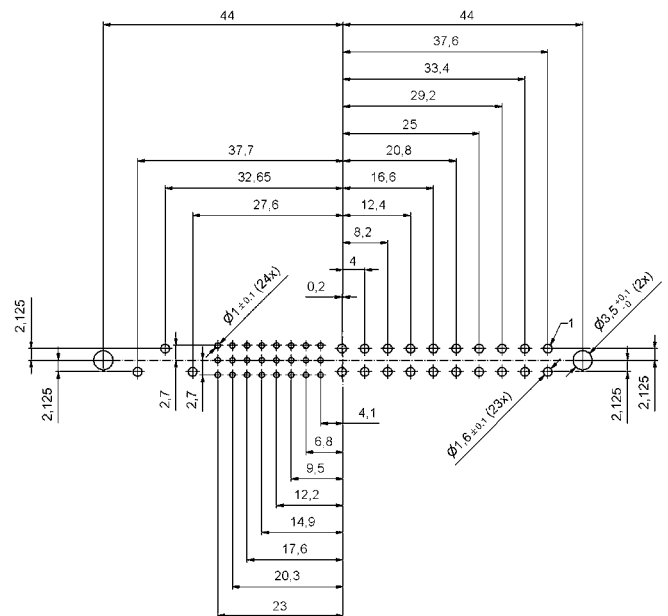

ORDER DATA

(Dim. = mm)

Number of positions	Contacts	Part number Quality class 3 (gold flash)	Part number Quality class 1 (0.8 μ m Au mating area)
47	24x signal / 23x power	CPH47 W23 FGRASK9 X	CPH47 W23 FGRCCK9 X

COMPACTPCI

Female connector – solder pin – straight – precision machined contacts – 47 positions

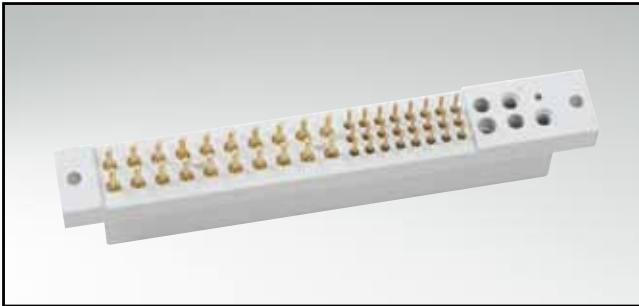

RoHS compliant – UL listed, File no.: E228329

DESCRIPTION

- Signal and power contacts
- Selectively loaded with 24x signal / 20x power
- Position 45 to 47 for crimp contacts (page 3 | 36)
- Contact plating quality class 1 or alternative quality class 3
- "Low Profile" area for crimp contacts
- Special contact loadings possible on request

PRODUCT DRAWING

PCB-hole pattern

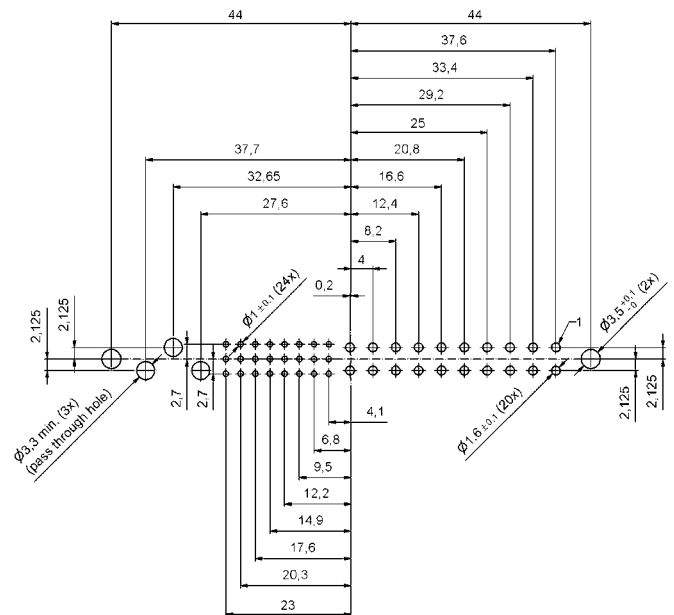
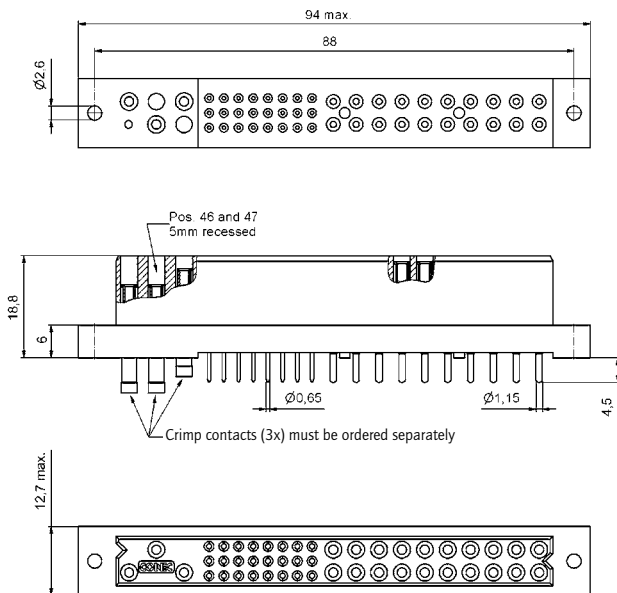

ORDER DATA

(Dim. = mm)

Number of positions	Contacts	Part number Quality class 3 (gold flash)	Part number Quality class 1 (0.8µm Au mating area)
47	24x signal / 20x power	CPH47 W23 FGRASN9 X	CPH47 W23 FGRCNS9 X

COMPACTPCI

Male connector – press fit – straight – precision machined contacts – 38 positions

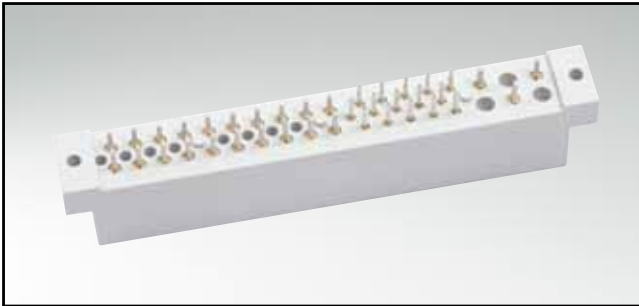

RoHS compliant – UL listed, File no.: E228329

DESCRIPTION

- Signal and power contacts
- 38 contacts, 15x signal / 23x power
- Sequential mating
- Eye of needle press fit design, tin plated
- Precision machined contact for the mating area
- Contact plating quality class 1 or alternative quality class 3
- Special contact loadings possible on request

PRODUCT DRAWING

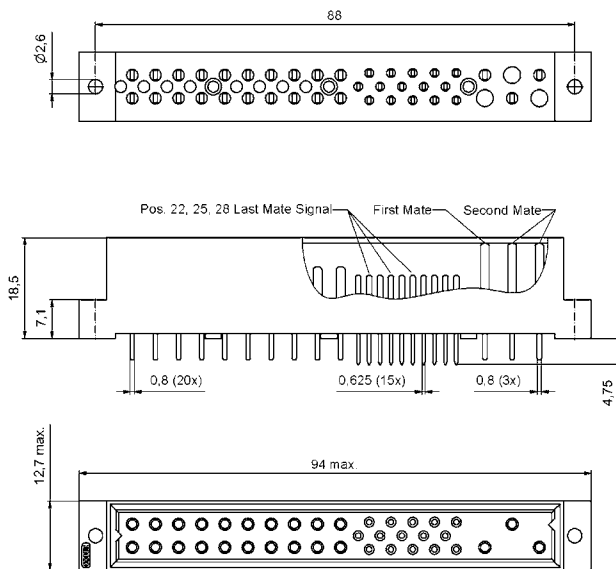

PCB-hole pattern

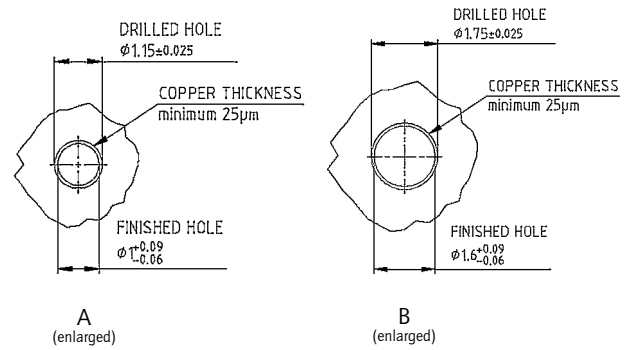
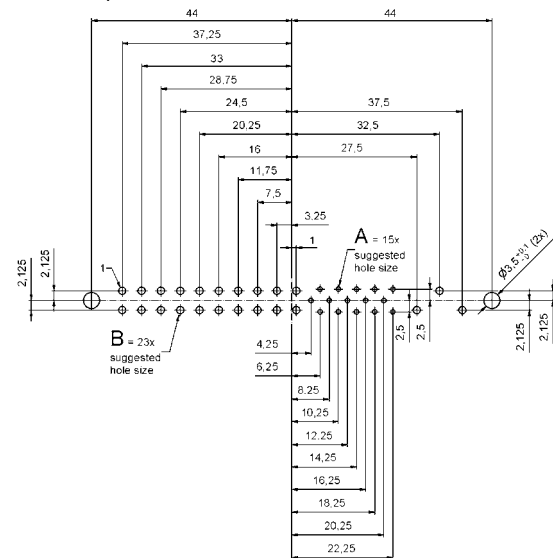

ORDER DATA

(Dim. = mm)

Number of positions	Contacts	Part number Quality class 3 (gold flash)	Part number Quality class 1 (0.8 μ m Au mating area)
38	15x signal / 23x power	CPH38 W23 MGE3SK9 X	CPH38 W23 MGE1SK9 X

COMPACTPCI

Male connector – press fit – straight – precision machined contacts – 47 positions

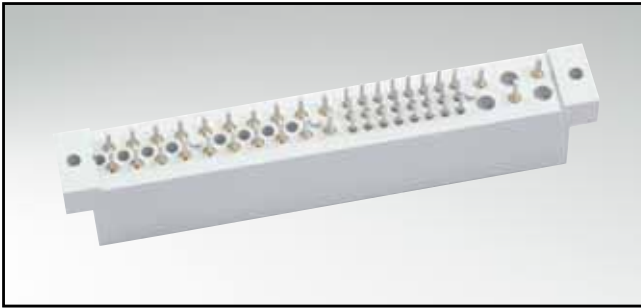

RoHS compliant – UL listed, File no.: E228329

DESCRIPTION

- Signal and power contacts
- 47 contacts, 24x signal / 23x power
- Sequential mating
- Eye of needle press fit design, tin plated
- Precision machined contact for the mating area
- Contact plating quality class 1 or alternative quality class 3
- Special contact loadings possible on request

PRODUCT DRAWING

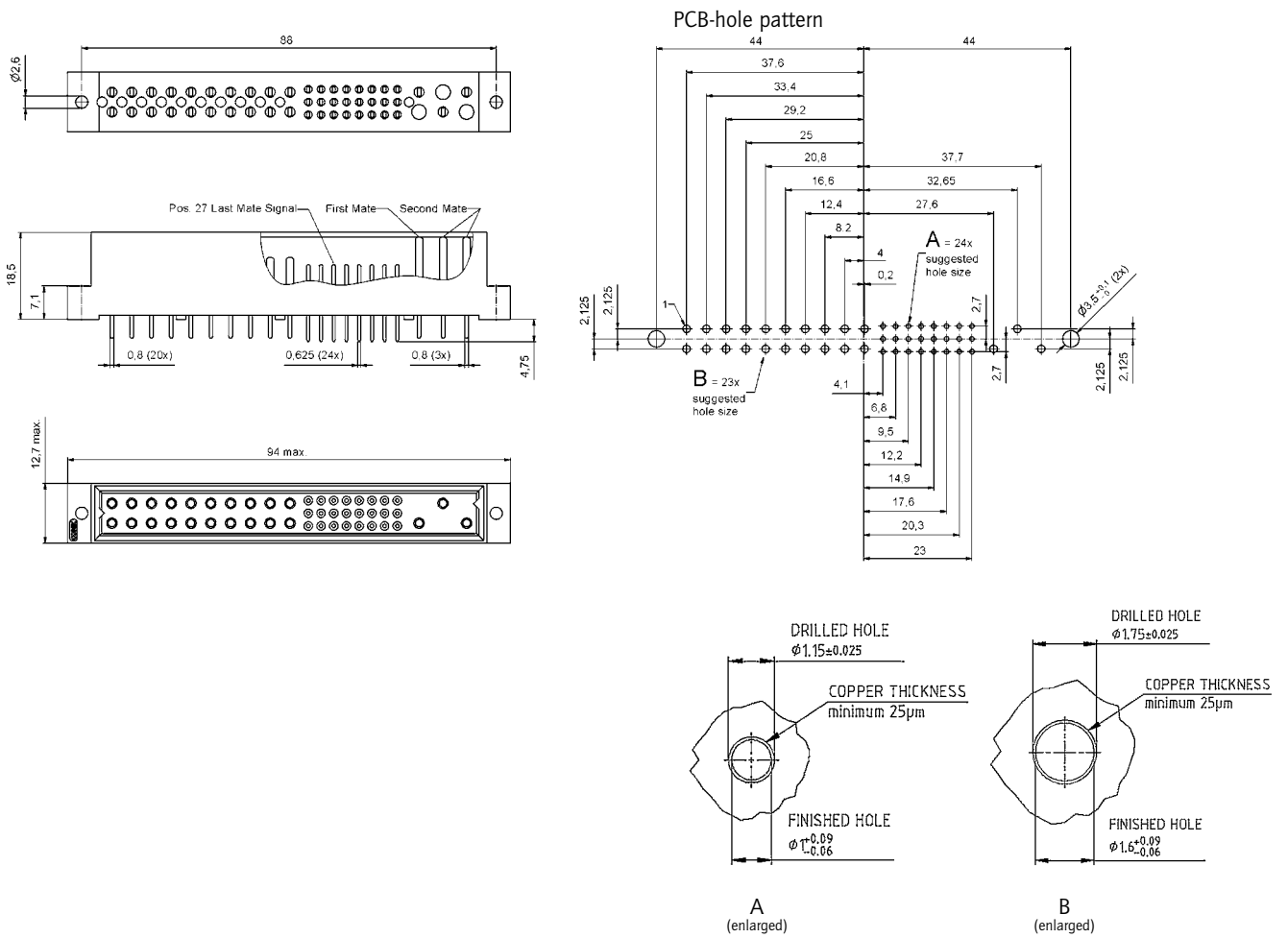

ORDER DATA

(Dim. = mm)

Number of positions	Contacts	Part number Quality class 3 (gold flash)	Part number Quality class 1 (0.8 μm Au mating area)
47	24x signal / 23x power	CPH47 W23 MGE3SK9 X	CPH47 W23 MGE1SK9 X

COMPACTPCI

Female connector – press fit – straight – precision machined contacts – 38 positions

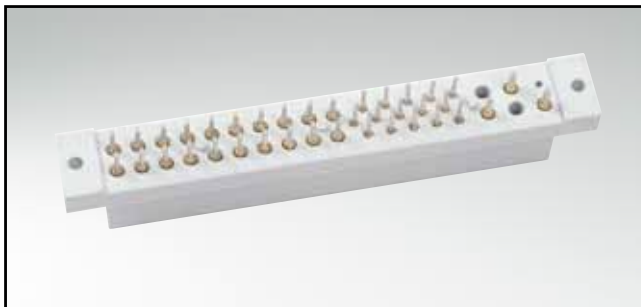

RoHS compliant – UL listed, File no.: E228329

DESCRIPTION

- Signal and power contacts
- 38 contacts, 15x signal / 23x power
- Sequential mating
- Eye of needle press fit design, tin plated
- Precision machined contact for the mating area
- Contact plating quality class 1 or alternative quality class 3
- Special contact loadings possible on request

PRODUCT DRAWING

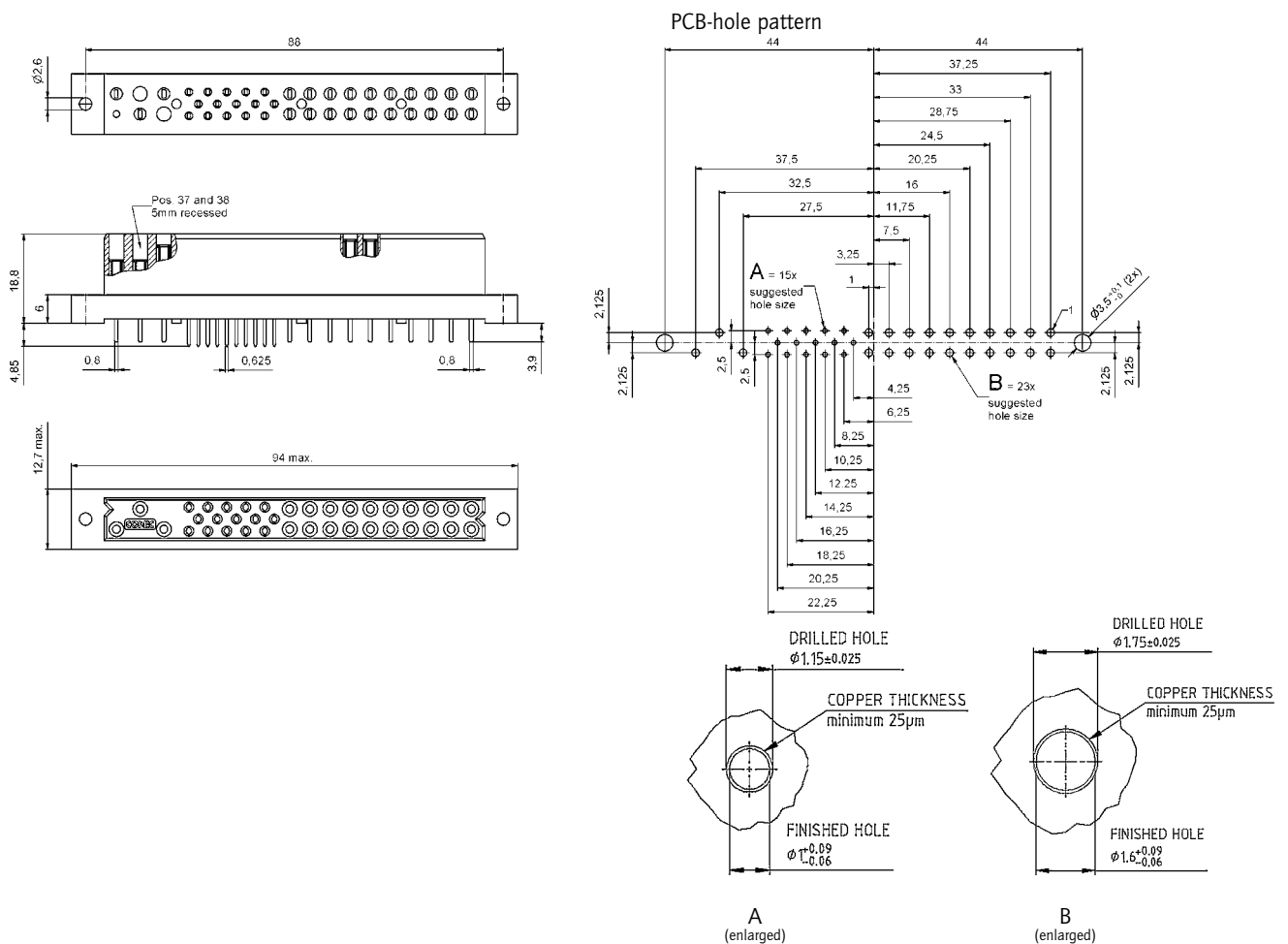

ORDER DATA

(Dim. = mm)

Number of positions	Contacts	Part number Quality class 3 (gold flash)	Part number Quality class 1 (0.8 μ m Au mating area)
38	15x signal / 23x power	CPH38 W23 FGE3SK9 X	CPH38 W23 FGE1SK9 X

COMPACTPCI

Female connector – press fit – straight – precision machined contacts – 38 positions

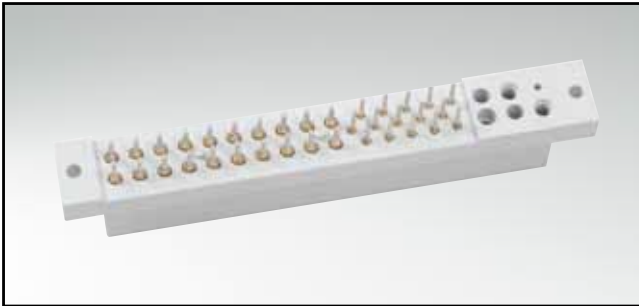

RoHS compliant – UL listed, File no.: E228329

DESCRIPTION

- Signal and power contacts
- Selectively loaded with 15x signal / 20x power
- Position 36 to 38 for crimp contacts (page 3 | 36)
- Eye of needle press fit design, tin plated
- Precision machined contact for the mating area
- Contact plating quality class 1 or alternative quality class 3
- "Low Profile" area for crimp contacts
- Special contact loadings possible on request

PRODUCT DRAWING

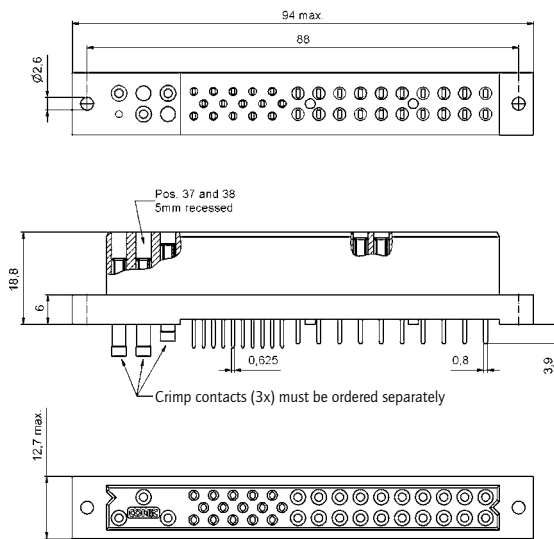

PCB-hole pattern

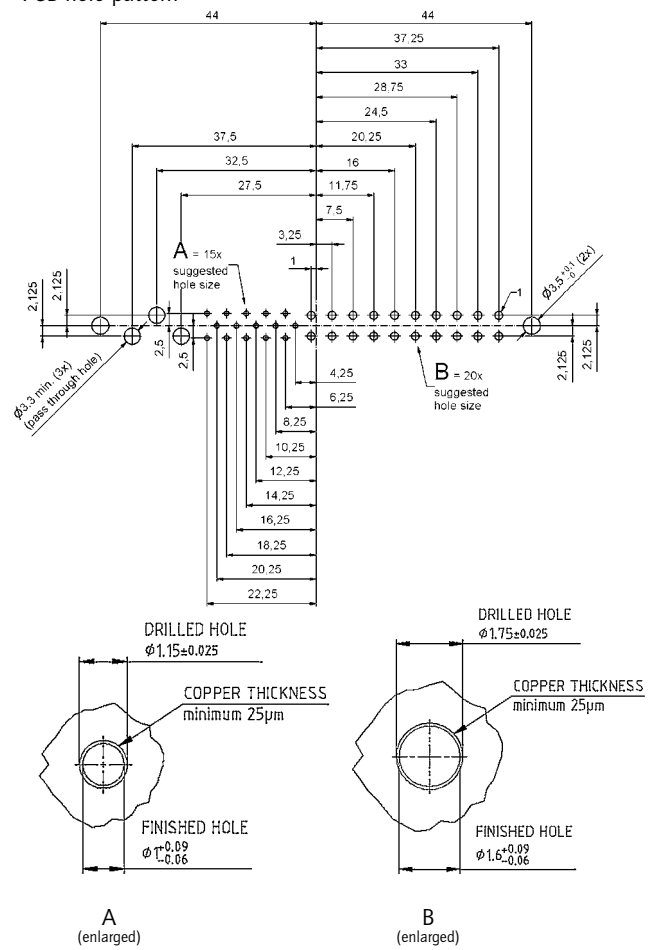

ORDER DATA

(Dim. = mm)

Number of positions	Contacts	Part number Quality class 3 (gold flash)	Part number Quality class 1 (0.8µm Au mating area)
38	15x signal / 20x power	CPH38 W23 FGE3SN9 X	CPH38 W23 FGE1SN9 X

COMPACTPCI

Female connector – press fit – straight – precision machined contacts – 38 positions

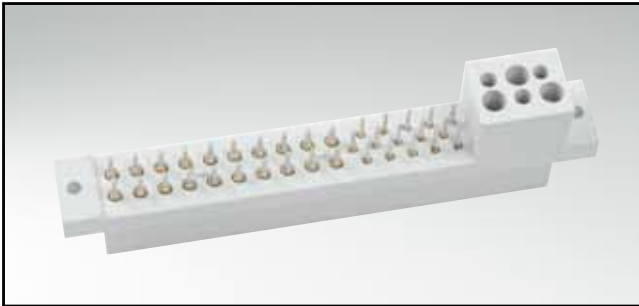

RoHS compliant – UL listed, File no.: E228329

DESCRIPTION

- Signal and power contacts
- Selectively loaded with 15x signal / 20x power
- Position 36 to 38 for crimp contacts (page 3 | 36)
- Eye of needle press fit design, tin plated
- Precision machined contact for the mating area
- Contact plating quality class 1 or alternative quality class 3
- "High Profile", insulation support for crimp contacts
- Special contact loadings possible on request

PRODUCT DRAWING

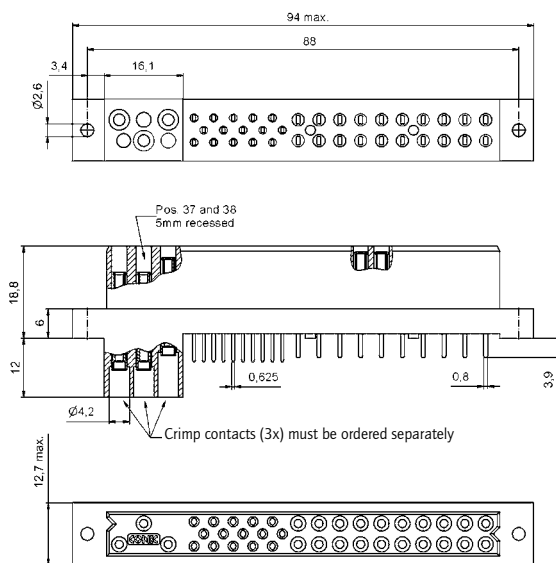

PCB-hole pattern

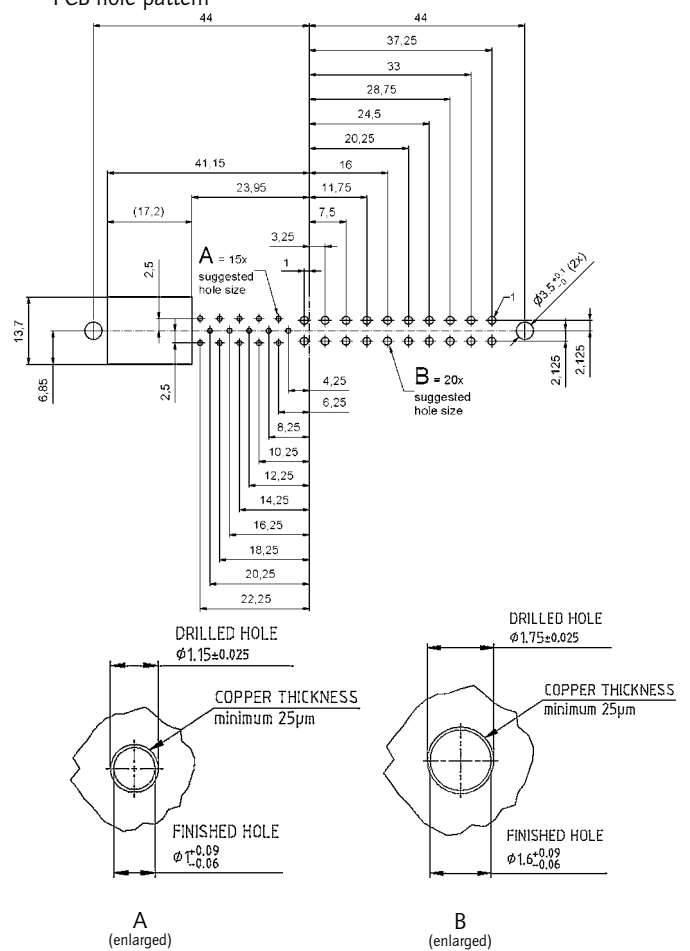

ORDER DATA

(Dim. = mm)

Number of positions	Contacts	Part number Quality class 3 (gold flash)	Part number Quality class 1 (0.8 μ m Au mating area)
38	15x signal / 20x power	CPH38 W23 FGE3SH9 X	CPH38 W23 FGE1SH9 X

COMPACTPCI

Female connector – press fit – straight – precision machined contacts – 47 positions

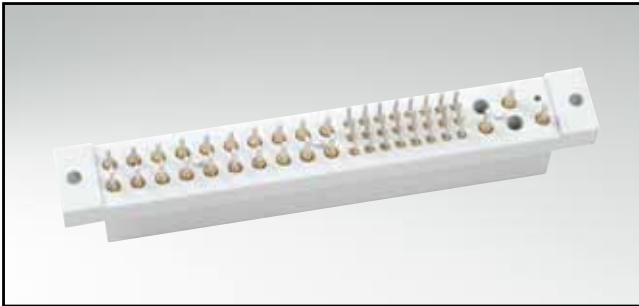

RoHS compliant – UL listed, File no.: E228329

DESCRIPTION

- Signal and power contacts
- 47 contacts, 24x signal / 23x power
- Sequential mating
- Eye of needle press fit design, tin plated
- Precision machined contact for the mating area
- Contact plating quality class 1 or alternative quality class 3
- Special contact loadings possible on request

PRODUCT DRAWING

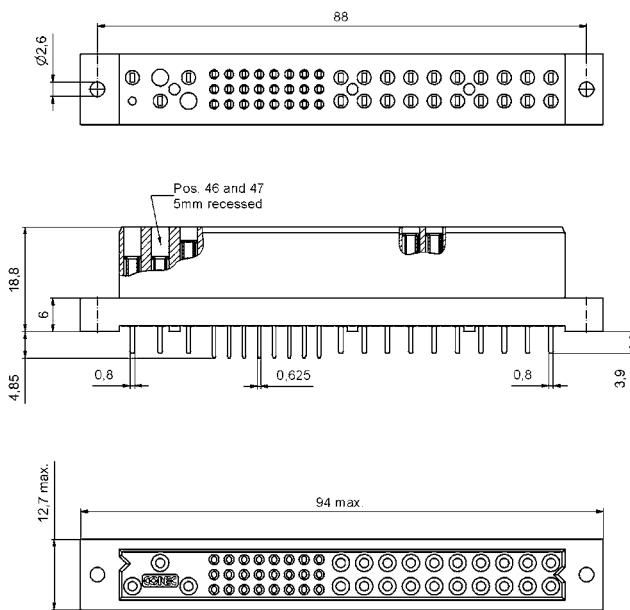

PCB-hole pattern

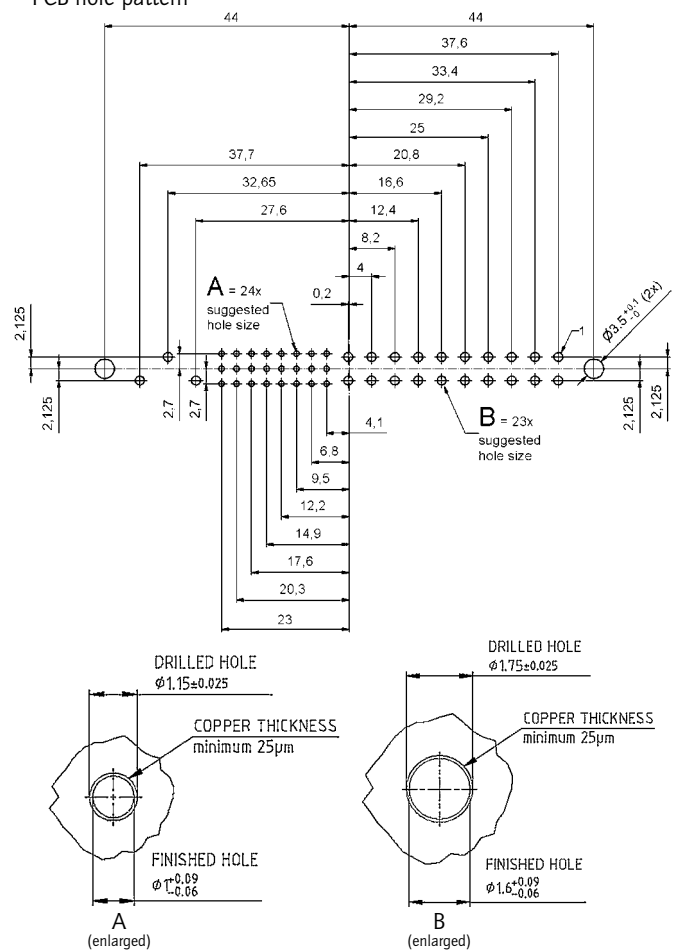

ORDER DATA

(Dim. = mm)

Number of positions	Contacts	Part number Quality class 3 (gold flash)	Part number Quality class 1 (0.8 μ m Au mating area)
47	24x signal / 23x power	CPH47 W23 FGE3SK9 X	CPH47 W23 FGE1SK9 X

COMPACTPCI

Female connector – press fit – straight – precision machined contacts – 47 positions

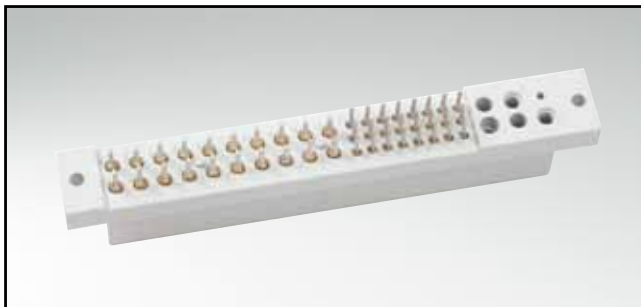

RoHS compliant – UL listed, File no.: E228329

DESCRIPTION

- Signal and power contacts
- Selectively loaded with 24x signal / 20x power
- Position 45 to 47 for crimp contacts (page 3 | 36)
- Eye of needle press fit design, tin plated
- Precision machined contact for the mating area
- Contact plating quality class 1 or alternative quality class 3
- "Low Profile" area for crimp contacts
- Special contact loadings possible on request

PRODUCT DRAWING

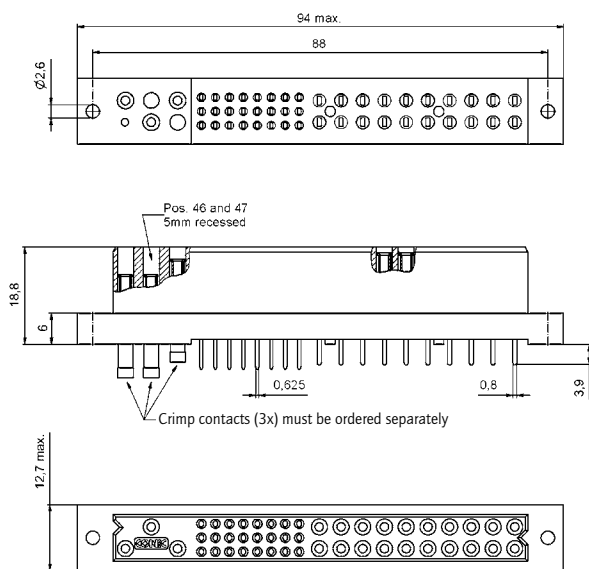

PCB-hole pattern

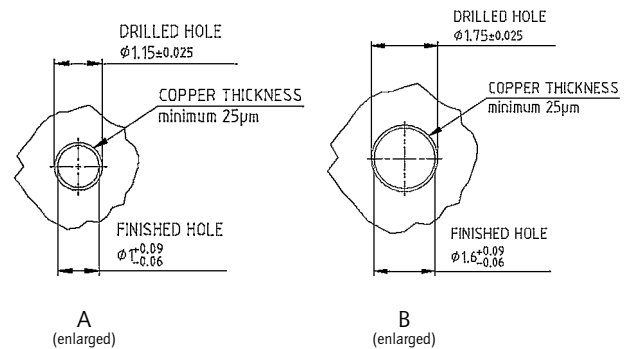
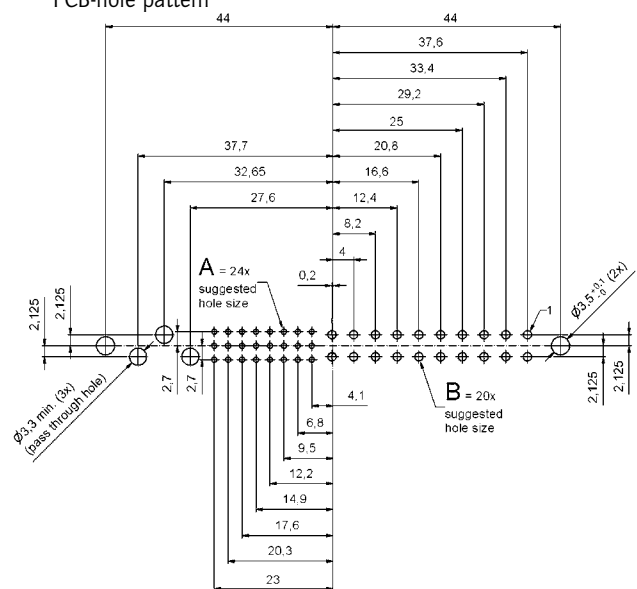

ORDER DATA

(Dim. = mm)

Number of positions	Contacts	Part number Quality class 3 (gold flash)	Part number Quality class 1 (0.8 μ m Au mating area)
47	24x signal / 20x power	CPH47 W23 FGE3SN9 X	CPH47 W23 FGE1SN9 X

COMPACTPCI

Female connector – press fit – straight – stamped contacts – 38 positions

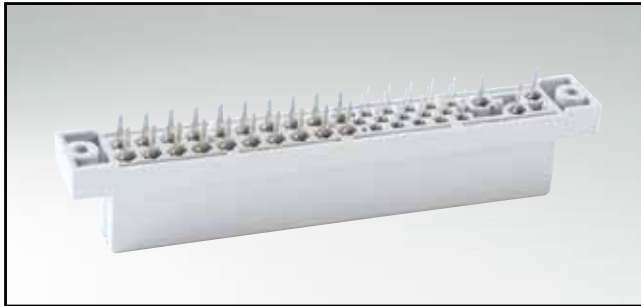

RoHS compliant

DESCRIPTION

- Signal and power contacts
- 38 contacts, 15x signal / 23x power
- Sequential mating
- Eye of needle press fit design, tin-plated
- Contact plating quality class 1 or alternative quality class 3
- Special contact loadings possible on request

PRODUCT DRAWING

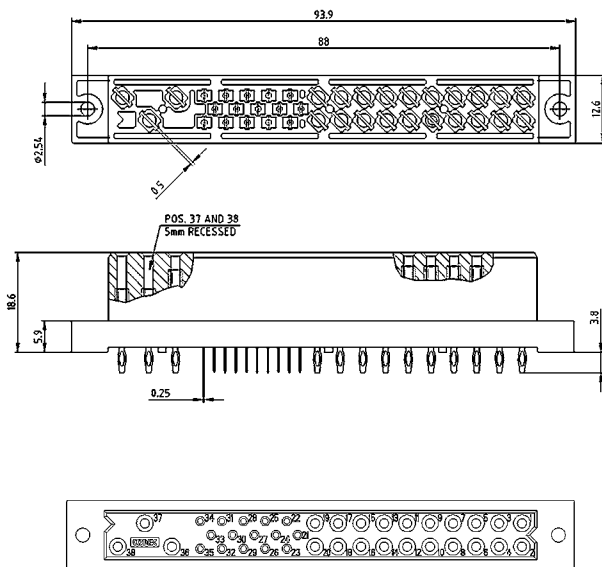

PCB-hole pattern

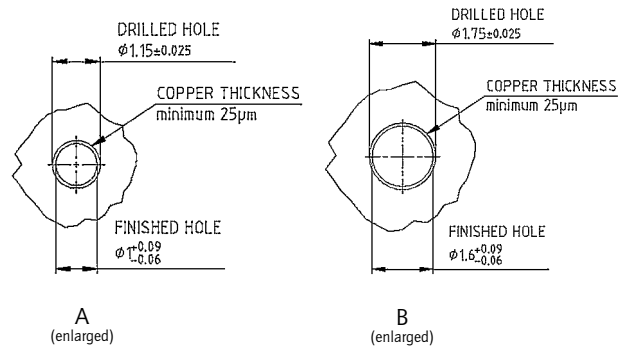
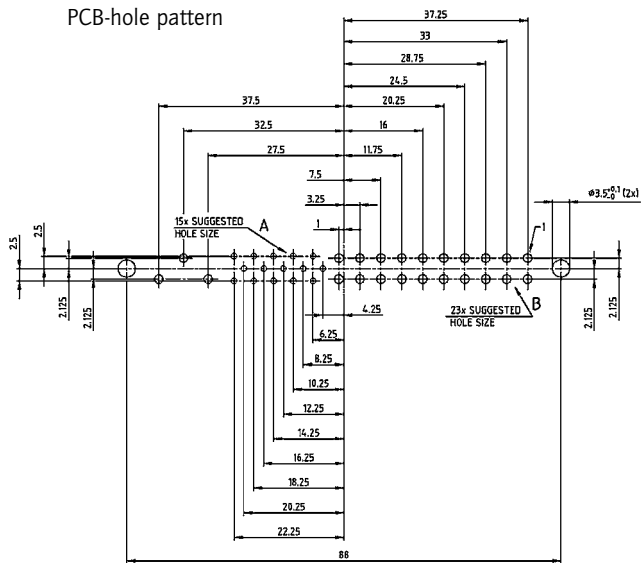

ORDER DATA

(Dim. = mm)

Number of positions	Contacts	Part number Quality class 3 (gold flash)	Part number Quality class 1 (0.8µm Au mating area)
38	15x signal / 23x power	45-000143	45-000141

COMPACTPCI

Female connector – press fit – straight – stamped – 47 positions

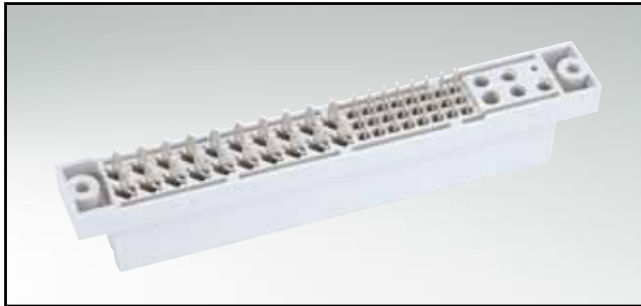

RoHS compliant

DESCRIPTION

- Signal and power contacts
- Selectively loaded with 24x signal / 20x power
- Position 45 to 47 for crimp contacts (page 3 | 36)
- Eye of needle press fit design, tin plated
- Contact plating quality class 1 or alternative quality class 3
- "Low Profile" area for crimp contacts
- Special contact loadings possible on request

PRODUCT DRAWING

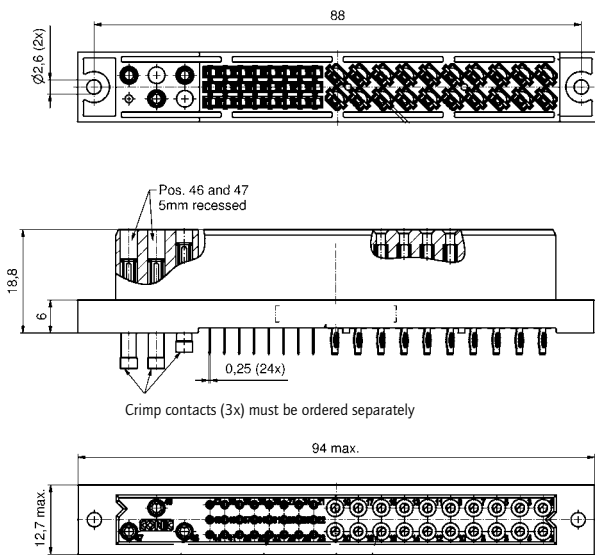

PCB-hole pattern

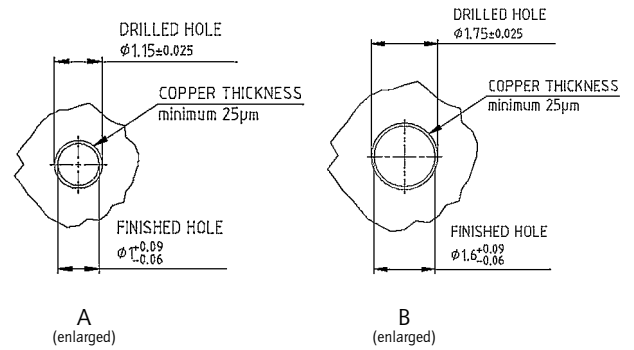
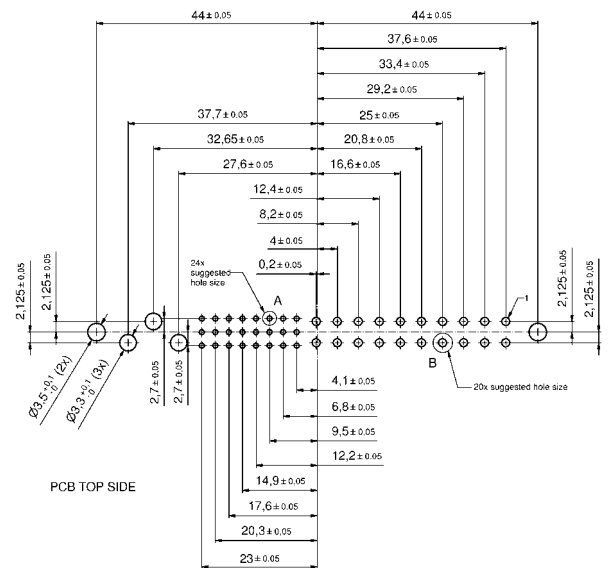

ORDER DATA

(Dim. = mm)

Number of positions	Contacts	Part number Quality class 3 (gold flash)	Part number Quality class 1 (0.8µm Au mating area)
47	24x signal / 20x power	45-000103	45-000101

COMPACTPCI

Female Connector – crimp version (without contacts) – 47 positions



RoHS compliant

DESCRIPTION

- For precision machined power- and signal contacts
- Power contacts are suitable for wire size AWG 12 to 24
- Signal contacts are suitable for wire size AWG 22
- For crimp contacts please see page 3 | 36

PRODUCT DRAWING

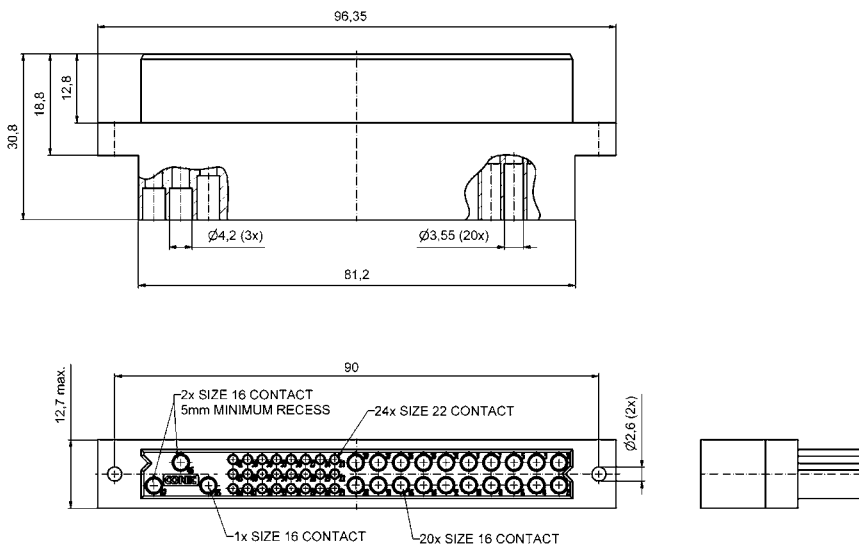

ORDER DATA

(Dim. = mm)

Number of positions	Part number
47	CPH 47W23 FXXXSH9 X

COMPACTPCI

Power and Signal crimp contacts – precision machined version



RoHS compliant

DESCRIPTION

- Power contacts are suitable for wire size AWG 12 to 24
- Signal contacts are suitable for wire size AWG 22
- Crimp tools see section 9
- Suitable connectors on page 3 | 16, 3 | 17, 3 | 21, 3 | 22, 3 | 24, 3 | 28, 3 | 29, 3 | 34 and 3 | 35
- Gold plated quality class 1 or alternative quality class 3

PRODUCT DRAWING

Power crimp contact

Signal crimp contact

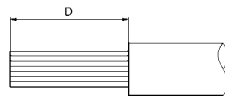
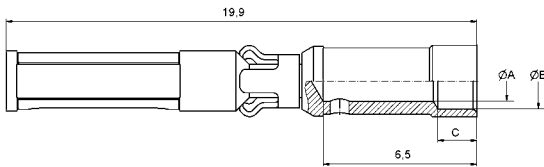

Cable stripping dimensions

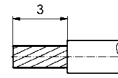
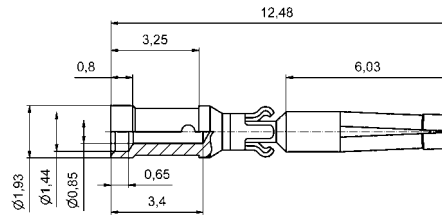

Cable stripping dimensions

for wire size	A	B	C	D
AWG 12	2.49	–	–	6.5
AWG 14-16	2.06	2.67	1.65	5.0
AWG 16-18	1.70	2.36	1.65	5.0
AWG 20-22-24	1.14	1.72	1.65	5.0

ORDER DATA

(Dim. = mm)

for wire size	Part number Quality class 3 (gold flash)	Part number Quality class 1 (0.8µm Au mating area)
Power crimp AWG 12	CPZC 1612FA X	CPZC 1612FC X
Power crimp AWG 14-16	CPZC 1614FA X	CPZC 1614FC X
Power crimp AWG 16-18	CPZC 1616FA X	CPZC 1616FC X
Power crimp AWG 20-22-24	CPZC 1620FA X	CPZC 1620FC X
Signal crimp AWG 22	CPZC 0822FA X	CPZC 0822FC X

COMPACTPCI / ADVANCEDTCA

Mounting screws



RoHS compliant

DESCRIPTION

- Mounting screws for PCB
- Material: steel, nickel-plated
- Different length for different PCB thicknesses

PRODUCT DRAWING

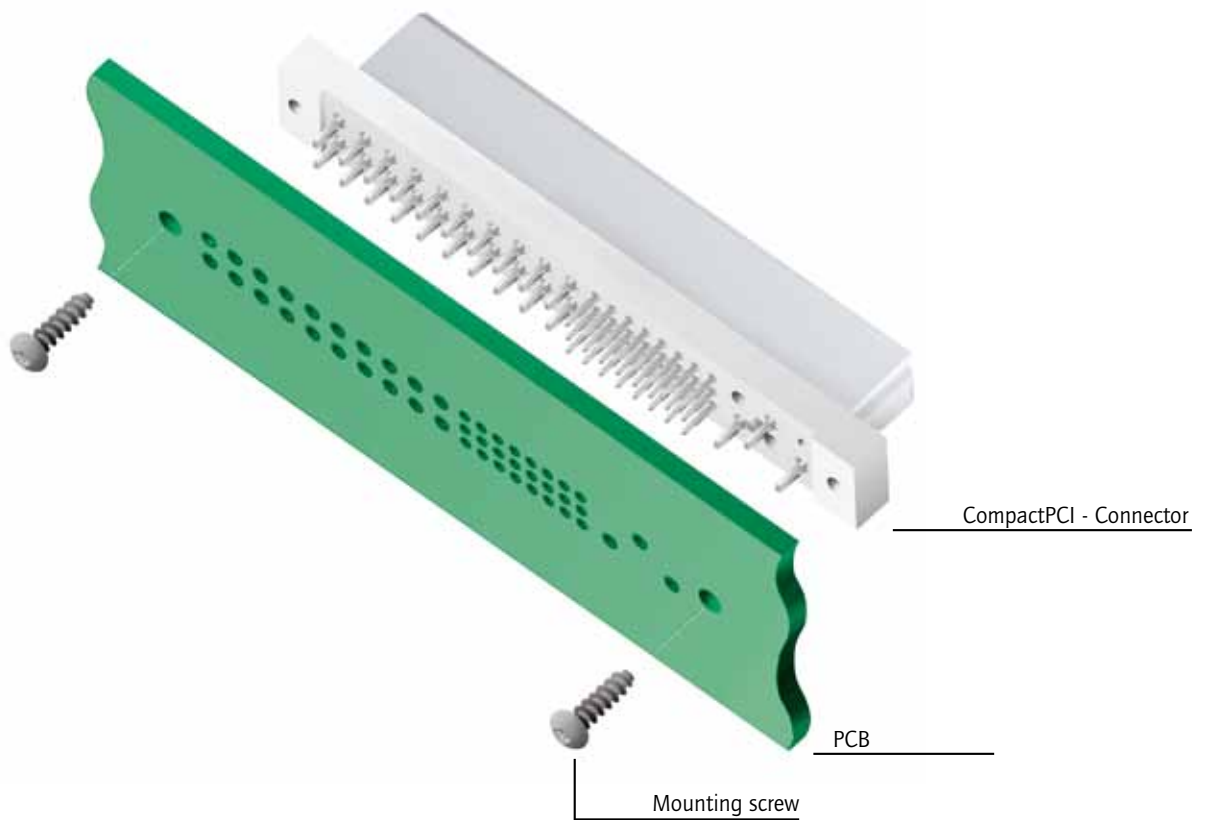

ORDER DATA

(Dim. = mm)

Screw for CompactPCI	Thread length	Screw for AdvancedTCA	Thread length
CPZS 0170 X	8.1 mm	CPZS 5170 X	6.0 mm
CPZS 0270 X	10.1 mm	CPZS 5270 X	8.0 mm
CPZS 0370 X	11.1 mm	CPZS 5370 X	10.0 mm
CPZS 0470 X	12.7 mm	CPZS 5470 X	12.0 mm

MINI POWER

Male Connector – solder pin – angled – precision machined contacts – 24 positions

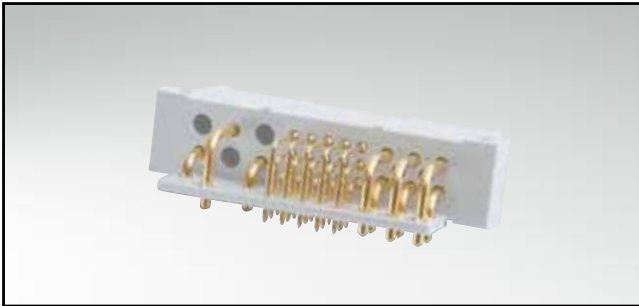

RoHS compliant

DESCRIPTION

- Signal and power contacts
- 24 contacts, 15x signal / 9x power
- Sequential mating
- Contact plating quality class 1 or alternative quality class 3
- Special contact loadings possible on request

PRODUCT DRAWING

PCB-hole pattern

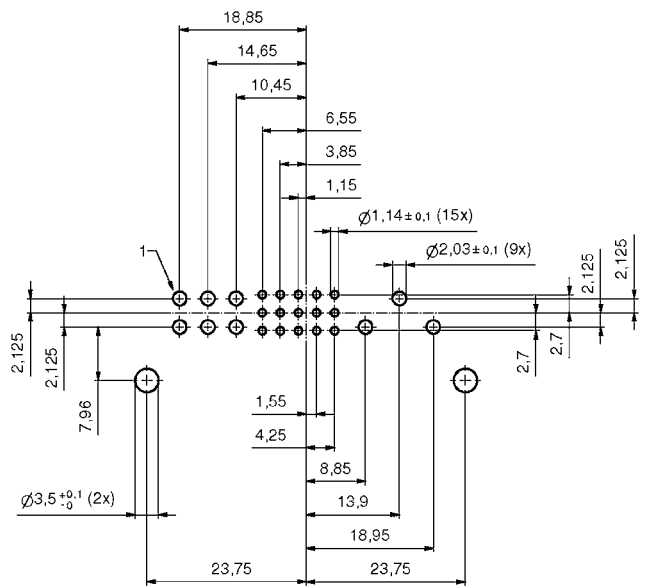
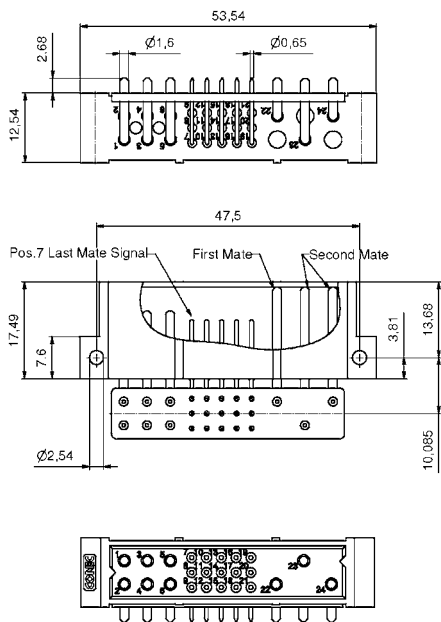

ORDER DATA

(Dim. = mm)

Number of positions	Contacts	Part number Quality class 3 (gold flash)	Part number Quality class 1 (0.8µm Au mating area)
24	15x signal / 9x power	CPD24 W09 MARASK9 X	CPD24 W09 MARCSK9 X

MINI POWER

Male connector – solder pin – angled – precision machined contacts – 26 positions

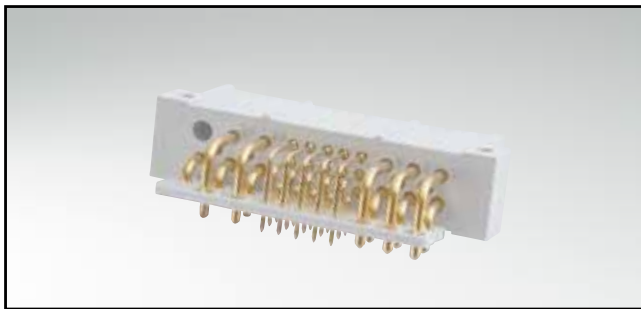

RoHS compliant

DESCRIPTION

- Signal and power contacts
- 26 contacts, 15x signal / 11x power
- Sequential mating
- Contact plating quality class 1 or alternative quality class 3
- Special contact loadings possible on request

PRODUCT DRAWING

PCB-hole pattern

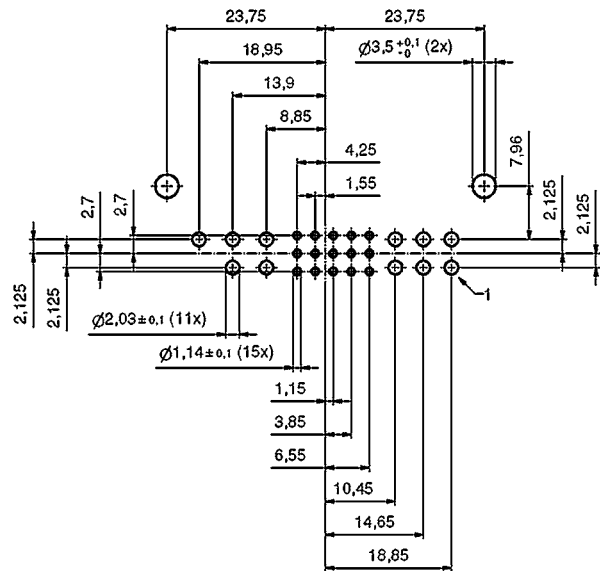
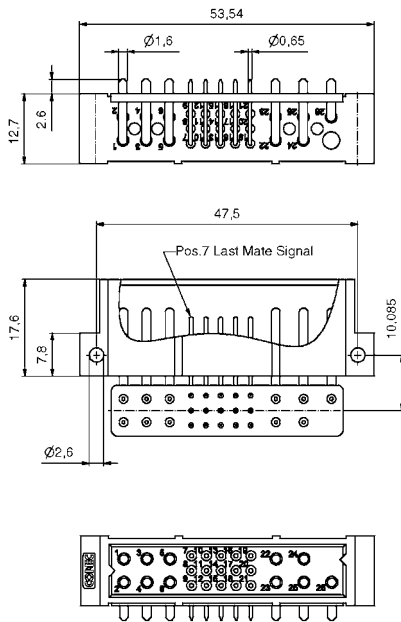

ORDER DATA

(Dim. = mm)

Number of positions	Contacts	Part number Quality class 3 (gold flash)	Part number Quality class 1 (0.8µm Au mating area)
26	15x signal / 11x power	CPD26 W11 MARASK9 X	CPD26 W11 MARCSK9 X

MINI POWER

Male connector – solder pin – straight – precision machined contacts – 24 positions

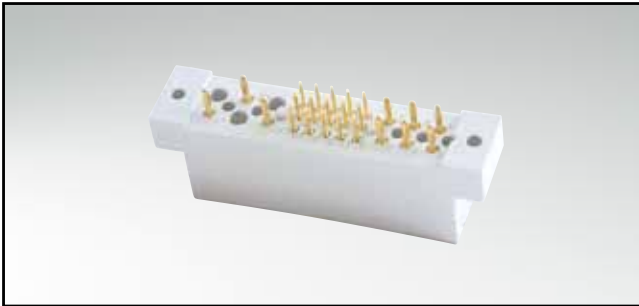

RoHS compliant

DESCRIPTION

- Signal and power contacts
- 24 contacts, 15x signal / 9x power
- Sequential mating
- Contact plating quality class 1 or alternative quality class 3
- Special contact loadings possible on request

PRODUCT DRAWING

PCB-hole pattern

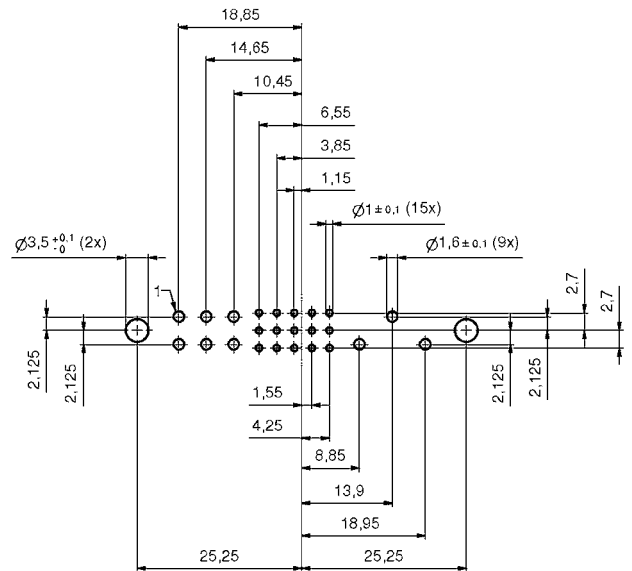
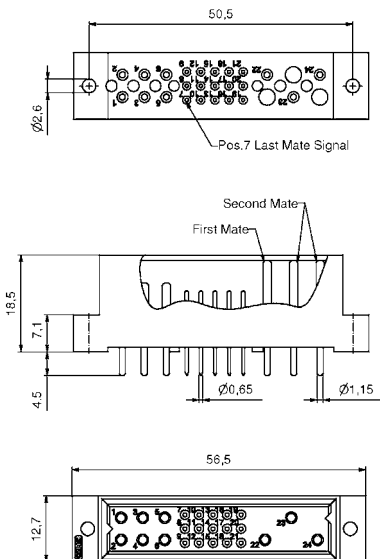

ORDER DATA

(Dim. = mm)

Number of positions	Contacts	Part number Quality class 3 (gold flash)	Part number Quality class 1 (0.8µm Au mating area)
24	15x signal / 9x power	CPD24 W09 MGRASK9 X	CPD24 W09 MGRCSK9 X

MINI POWER

Male connector – solder pin – straight – precision machined contacts – 26 positions

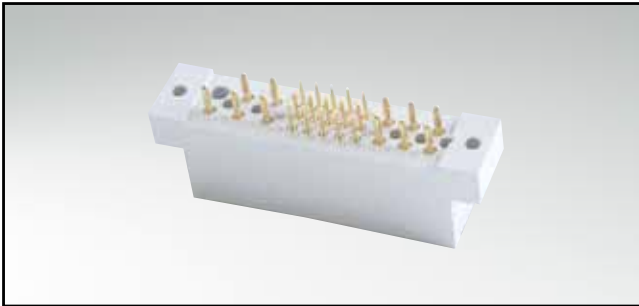

RoHS compliant

DESCRIPTION

- Signal and power contacts
- 26 contacts, 15x signal / 11x power
- Sequential mating
- Contact plating quality class 1 or alternative quality class 3
- Special contact loadings possible on request

PRODUCT DRAWING

PCB-hole pattern

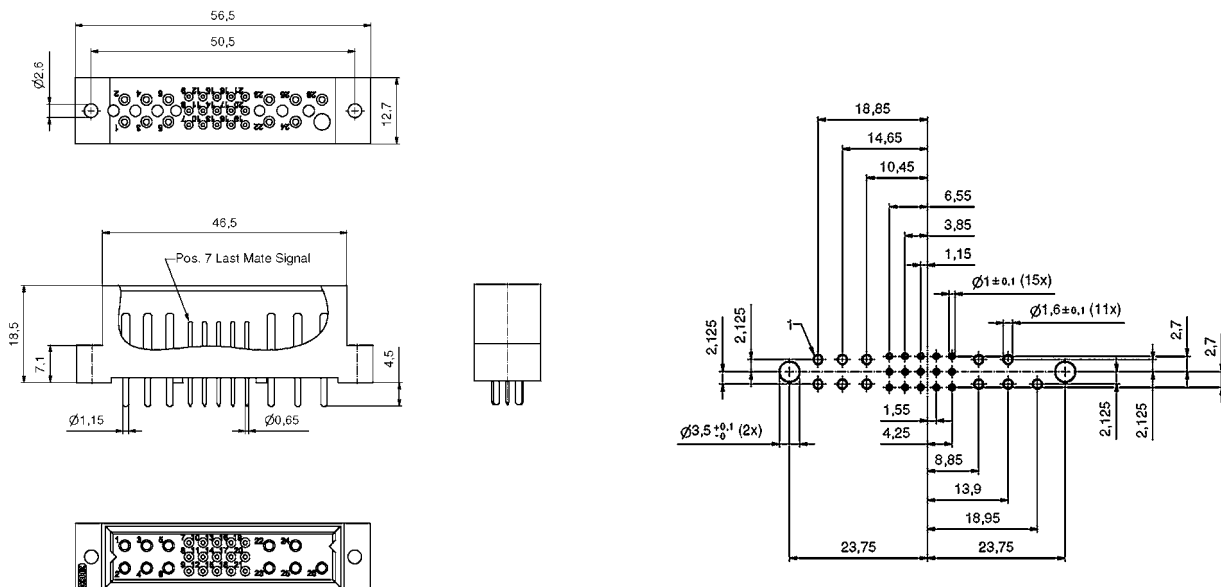

ORDER DATA

(Dim. = mm)

Number of positions	Contacts	Part number Quality class 3 (gold flash)	Part number Quality class 1 (0.8µm Au mating area)
26	15x signal / 11x power	CPD26 W11 MGRASK9 X	CPD26 W11 MGRCSK9 X

MINI POWER

Female connector – press fit – straight – stamped – 24 positions

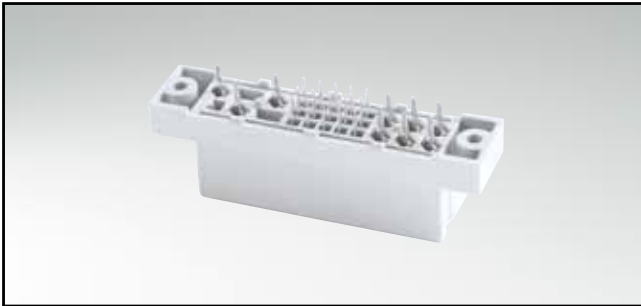

RoHS compliant

DESCRIPTION

- Signal and power contacts
- 24 contacts, 15x signal / 9x power
- Sequential mating
- Eye of needle press fit design, tin-plated
- Contact plating quality class 1 or alternative quality class 3
- Special contact loadings possible on request

PRODUCT DRAWING

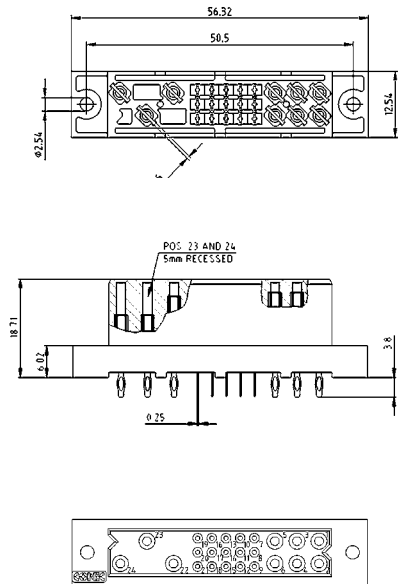

PCB-hole pattern

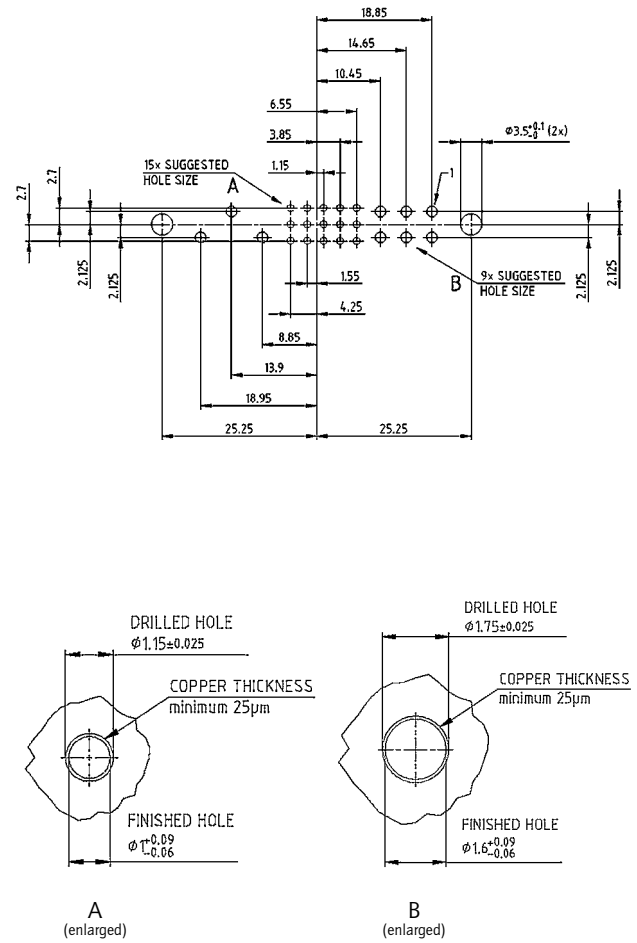

ORDER DATA

(Dim. = mm)

Number of positions	Contacts	Part number Quality class 3 (gold flash)	Part number Quality class 1 (0.8µm Au mating area)
24	15x signal / 9x power	45-000123	45-000121

SECTION 4

CONNECTORS DIN EN 60603-2

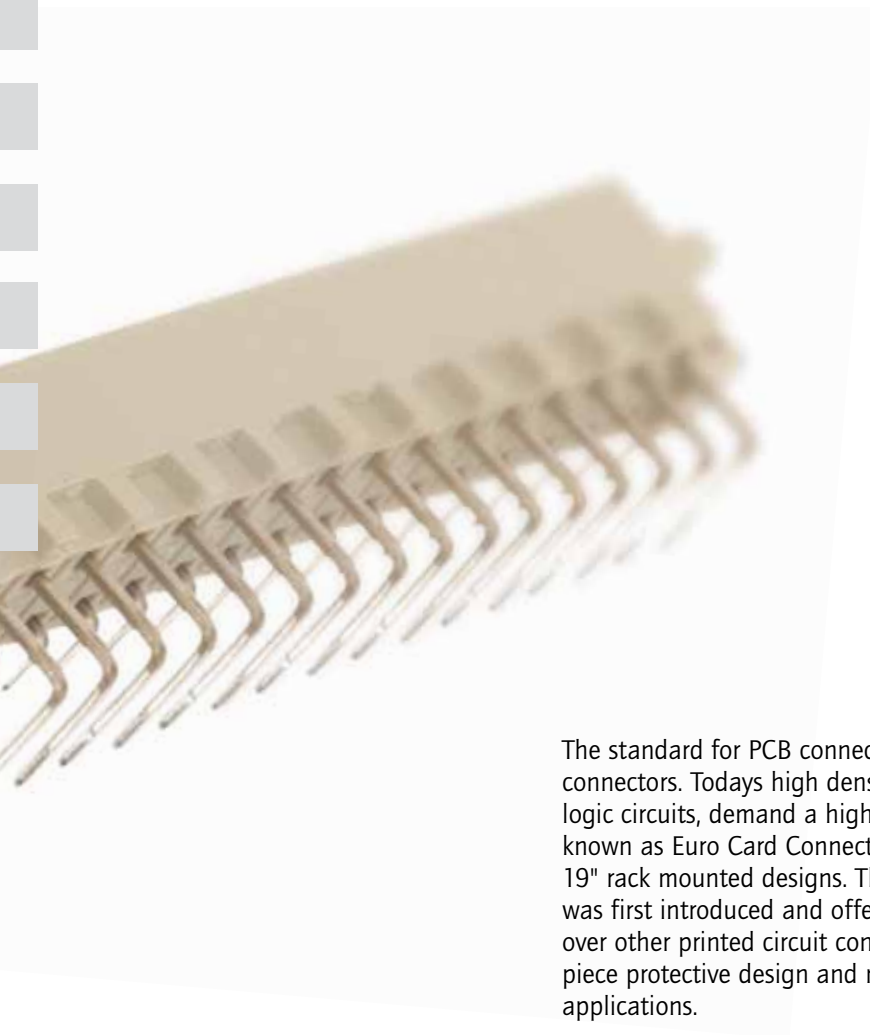

The standard for PCB connectors has been set by the DIN EN 60603-2 two piece connectors. Today's high density packing applications, combined with high speed logic circuits, demand a high reliability interconnection system. The series is also known as Euro Card Connectors, gained popularity due to the similarity with 19" rack mounted designs. The product family has grown over the years since it was first introduced and offers significant improvements in performance and design over other printed circuit connectors. High contact density, low mating force, two piece protective design and many contact termination styles offer unlimited design applications.

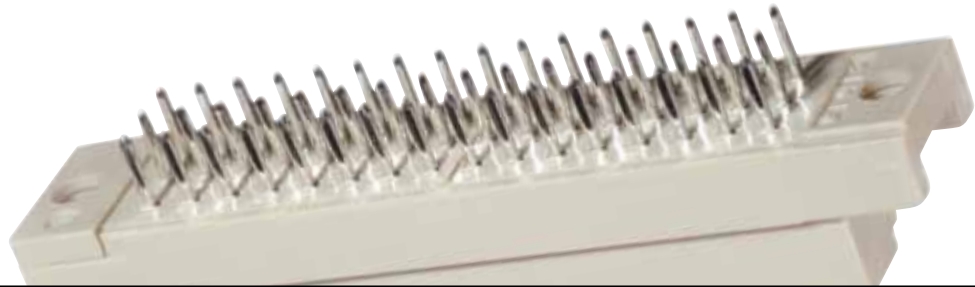

CONEC manufactures a wide range of products; series B, C, R, D, E, F, G, H and half size types are also available. Termination methods include: PCB direct soldering, solder eyelet, wire wrap, crimp, faston terminals and screw terminals.

In addition, we manufacture custom products or variations to existing designs with short design cycle and turn around.

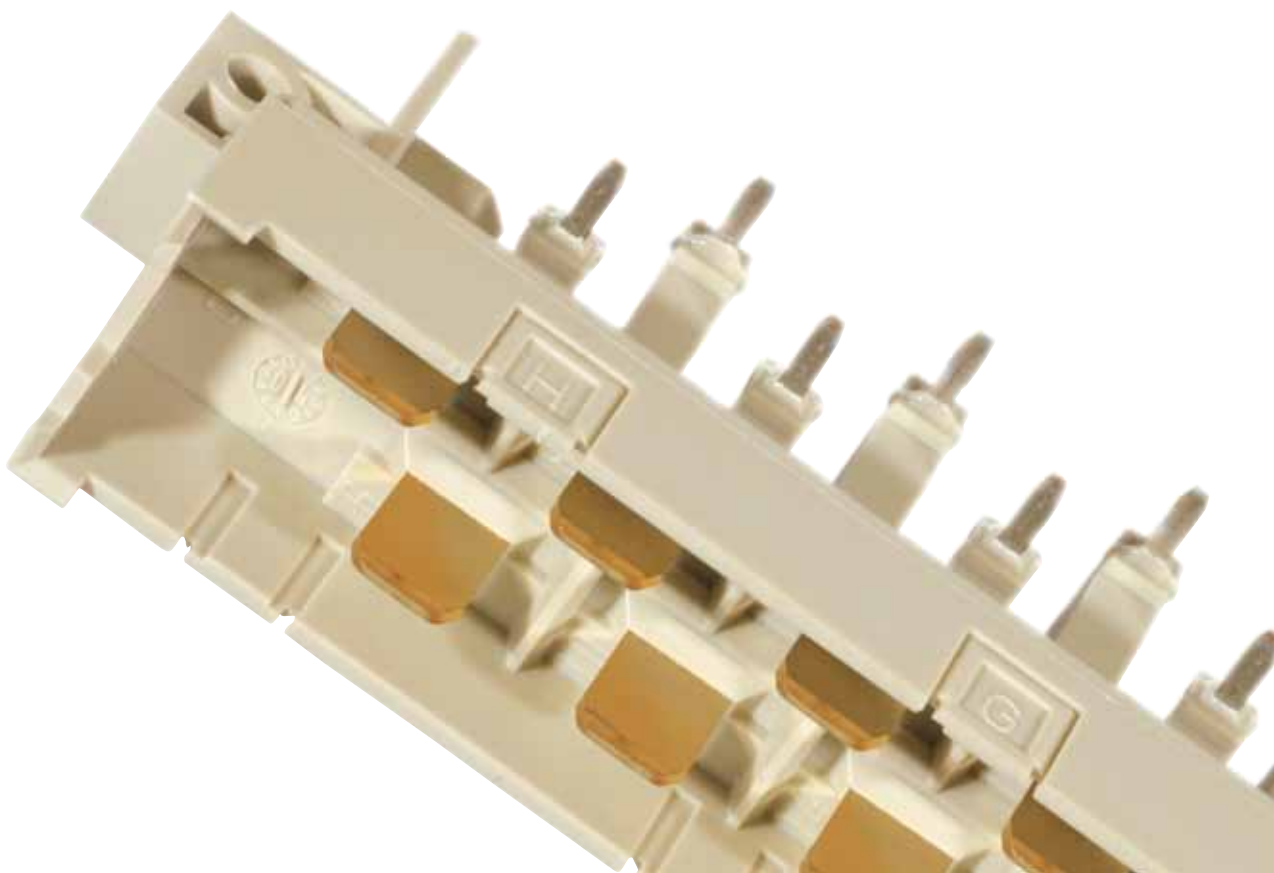

TECHNICAL DATA

Materials		Type B, B/2	Type C, C/2	Type R, R/2	Type D	Type E
Insulator		PBT GF				
Flammability		UL 94 V-0				
Contacts		Copper alloy				
Contact plating		gold over nickel				
Creepage distance	contact-ground contact-contact	≥ 1.2 mm			≥ 3 mm	
Clearance distance	contact-ground contact-contact	≥ 1.2 mm			≥ 3 mm	
Initial contact resistance		≤ 20 mΩ			≤ 15 mΩ	
Initial insulation resistance	Quality class 1 Quality class 2 Quality class 3	≥ 10 ¹² Ω ≥ 10 ¹² Ω ≥ 10 ¹¹ Ω				
Working voltage		250 V depending on insulation coordination (refer to DIN VDE 0110/IEC 664-1)			125 V	
Working current	+ 20 °C + 70 °C + 100 °C	2 A 1 A 0.5 A			5.5 A 4 A 2.5 A	
Working temperature		-55 °C to +125 °C				
Insulation group		A			C	
Test voltage V.r.m.s.	contact-ground contact-contact	1550 V 1000 V			1550 V 1550 V	
Insertion and withdrawal forces max.		16 positions 15 N 96 positions 90 N			16 positions 20 N 32 positions 40 N	16 positions 20 N 32 positions 40 N 48 positions 60 N
Quality class 3		50 cycles				
Quality class 2		400 cycles				
Quality class 1		500 cycles				

Technical alterations are subjects to change without notice.

TECHNICAL DATA

Materials		Type F	Type G	Type H	Mixed version	
Insulator		PBT GF	PBT GF	PC (Polycarbonat)		
Flammability		UL94 V-0	UL94 V-0	UL94 V-1		
Contacts		Copper alloy				
Contact Plating		gold over nickel		silver	gold over nickel	silver
Creepage distance	contact-ground	≥ 1.6 mm	≥ 1.6 mm (f+z)	≥ 4.5 mm	≥ 1.6 mm	≥ 4.5 mm
	contact-contact					
Clearance distance	contact-ground	≥ 3 mm	≥ 3 mm	≥ 8 mm	≥ 3 mm	≥ 8 mm
	contact-contact		≥ 1.9 mm (f+z)			
Initial contact resistance		≤ 15 mΩ				≤ 8 mΩ
Initial insulation resistance	Quality class 1	≥ 10 ¹² Ω				
	Quality class 2	≥ 10 ¹² Ω				
	Quality class 3	≥ 10 ¹¹ Ω				
Working voltage		125 V	500 V	125 V	500 V	
depending on insulation coordination (refer to DIN VDE 0110 / IEC 664-1)						
Working current	+ 20 °C	5.5 A	15 A	5.5 A	15 A	
	+ 70 °C	4 A	12 A	4 A	12 A	
	+ 100 °C	2.5 A	8 A	2.5 A	8 A	
Working temperature		-55 °C to +125 °C				
Insulation group		C				
Test voltage V.r.m.s.	contact-ground	2550 V	2500 V	3100 V	1550 V	3100 V
	contact-contact	1550 V	1550 V	3100 V	1550 V	3100 V
Insertion and withdrawal forces max.		32 positions 50 N 48 positions 75 N	64 positions 100 N	11 positions 80 N 15 positions 90 N	16+7 positions 67 N 24+7 positions 79 N 36+7 positions 96 N	
Quality class 3		50 cycles				
Quality class 2		400 cycles		500 cycles		
Quality class 1		500 cycles				

Technical alterations are subjects to change without notice.

DERATING DIAGRAMS

Types B, C, R

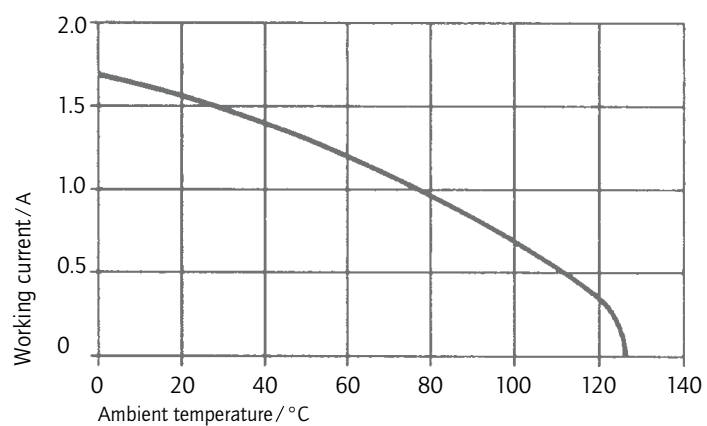

Types D, E, F, G

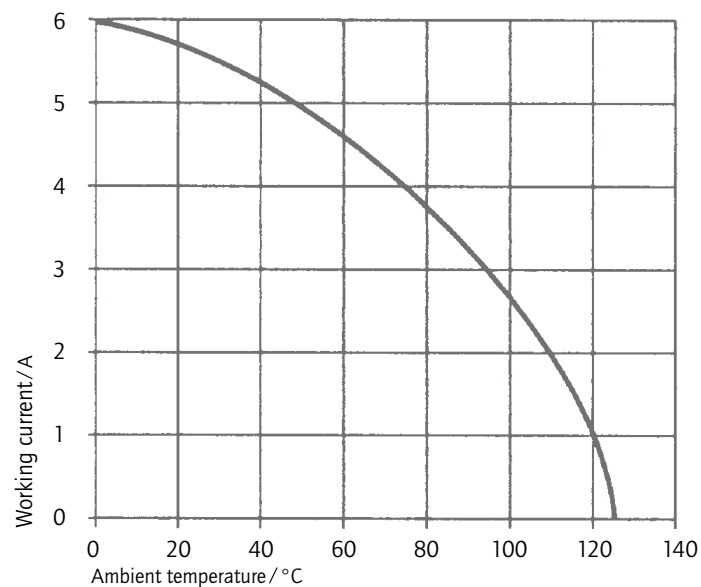

Type H 15

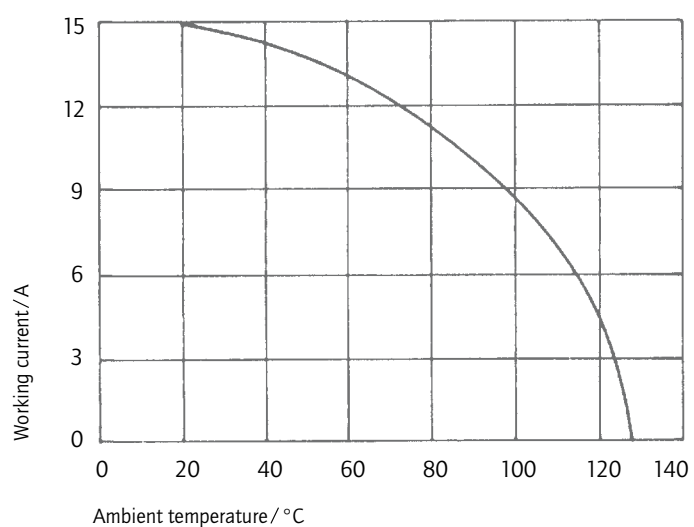

Type H 11

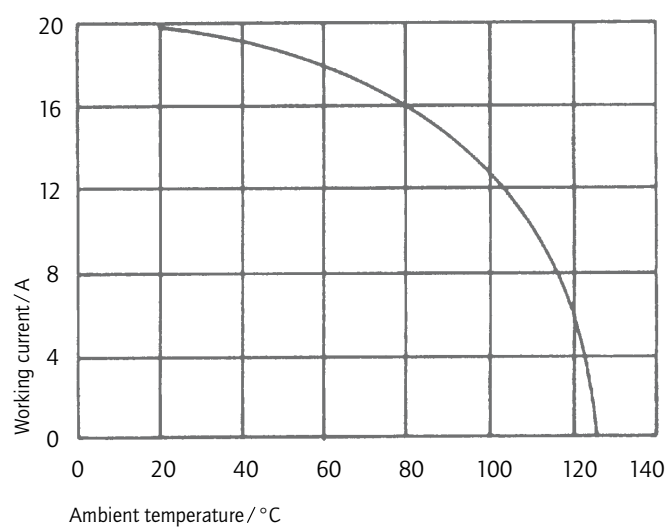

CONVERSION TABLE

μm 1/1000 mm	μinch 1/1000 inch	mm	inch	mm	inch	mm	inch	mm	inch	mm	inch
0,10	4	3,30	.130	10,16	.400	19,50	.768	30,90	1.217	49,50	1.949
0,20	8	3,40	.134	10,26	.402	19,70	.776	31,00	1.220	49,90	1.965
0,25	10	3,50	.138	10,36	.406	19,80	.780	31,20	1.228	50,10	1.972
0,30	12	3,60	.142	10,56	.413	19,90	.783	31,50	1.240	50,30	1.980
0,50	20	3,70	.146	10,66	.417	20,00	.787	31,70	1.248	50,50	1.988
0,70	28	3,80	.150	10,76	.421	20,10	.791	32,00	1.260	50,70	1.996
0,75	30	3,81	.150	11,00	.433	20,30	.799	32,20	1.268	50,80	2.000
0,80	32	3,90	.154	11,20	.441	20,32	.800	32,30	1.272	51,40	2.024
1,00	39	4,00	.158	11,40	.449	20,50	.807	32,50	1.280	51,50	2.028
1,27	50	4,10	.161	11,50	.453	21,00	.827	32,80	1.291	52,00	2.047
2,00	79	4,20	.165	11,60	.457	21,10	.831	33,00	1.299	52,30	2.059
2,50	98	4,30	.169	11,90	.469	21,70	.854	33,10	1.303	52,80	2.079
3,00	118	4,50	.177	12,00	.472	22,00	.866	33,30	1.311	53,00	2.087
4,00	157	4,70	.185	12,20	.480	22,10	.870	33,80	1.331	53,20	2.095
5,00	197	4,90	.193	12,30	.484	22,20	.874	34,00	1.339	53,80	2.118
		5,00	.197	12,40	.488	22,30	.878	34,20	1.346	54,00	2.126
mm	inch	5,08	.200	12,50	.492	22,40	.882	34,40	1.354	54,20	2.134
0,10	.004	5,10	.201	12,70	.500	22,50	.886	35,00	1.378	54,90	2.161
0,20	.008	5,20	.205	12,90	.508	22,60	.890	35,40	1.394	55,00	2.165
0,25	.012	5,30	.209	13,00	.512	22,80	.898	35,50	1.398	55,40	2.181
0,35	.014	5,40	.213	13,10	.516	22,86	.900	35,56	1.400	55,70	2.193
0,40	.016	5,40	.213	13,20	.520	22,90	.902	35,60	1.402	56,60	2.228
0,45	.018	5,50	.217	13,50	.532	23,00	.906	36,00	1.417	57,40	2.260
0,50	.020	5,60	.220	13,60	.535	23,10	.909	36,50	1.437	57,80	2.276
0,55	.022	5,70	.224	13,70	.539	23,30	.917	36,60	1.441	57,90	2.280
0,60	.024	5,80	.228	13,90	.547	23,50	.925	36,70	1.445	58,42	2.300
0,64	.025	6,00	.236	14,00	.551	24,00	.945	37,00	1.457	59,00	2.323
0,65	.026	6,10	.240	14,30	.563	24,30	.957	37,30	1.469	59,20	2.331
0,70	.028	6,40	.252	14,40	.567	24,60	.969	37,50	1.476	59,80	2.354
0,75	.030	6,50	.256	14,50	.571	24,90	.980	37,60	1.480	59,90	2.358
0,80	.032	6,60	.260	14,70	.579	25,00	.984	37,70	1.484	60,00	2.362
0,85	.034	6,70	.264	14,80	.583	25,10	.998	37,90	1.492	60,96	2.400
0,90	.035	6,80	.268	14,90	.587	25,40	1.000	38,00	1.496	61,10	2.406
1,00	.039	6,90	.272	14,98	.590	25,60	1.008	38,10	1.500	62,00	2.441
1,20	.047	7,00	.276	15,00	.591	25,90	1.020	39,00	1.535	63,00	2.480
1,25	.049	7,10	.280	15,20	.598	26,00	1.024	39,20	1.543	63,50	2.500
1,27	.050	7,20	.283	15,24	.600	26,30	1.035	39,30	1.547	64,00	2.520
1,30	.051	7,40	.291	15,40	.606	26,60	1.047	39,90	1.571	65,00	2.560
1,35	.053	7,50	.295	15,50	.610	26,70	1.051	40,00	1.575	67,00	2.638
1,40	.055	7,60	.299	15,60	.614	27,00	1.063	40,30	1.587	68,00	2.677
1,45	.057	7,62	.300	15,90	.626	27,20	1.071	40,40	1.591	69,00	2.717
1,50	.059	7,70	.303	16,00	.630	27,40	1.079	40,60	1.598	70,00	2.756
1,60	.063	7,80	.307	16,20	.638	27,50	1.093	41,00	1.614	71,00	2.795
1,70	.067	7,98	.314	16,50	.650	27,90	1.098	41,60	1.638	74,00	2.913
1,80	.071	8,00	.315	16,60	.654	27,94	1.100	42,70	1.681	75,00	2.953
1,85	.073	8,18	.318	16,80	.661	28,00	1.102	43,18	1.700	76,20	3.000
1,90	.075	8,20	.323	17,00	.669	28,20	1.110	44,20	1.740	77,00	3.032
2,00	.079	8,30	.327	17,20	.677	28,50	1.122	44,80	1.764	78,74	3.100
2,10	.083	8,40	.331	17,30	.681	28,70	1.130	45,80	1.803	80,00	3.150
2,20	.087	8,50	.335	17,50	.689	29,00	1.142	46,30	1.823	81,28	3.200
2,30	.091	8,60	.339	17,60	.693	29,20	1.150	46,70	1.839	84,00	3.307
2,40	.095	8,90	.350	17,70	.697	29,40	1.158	47,00	1.850	85,00	3.346
2,50	.098	9,00	.354	17,78	.700	29,50	1.161	47,20	1.858	86,36	3.400
2,54	.100	9,10	.358	17,80	.701	29,70	1.169	47,30	1.862	88,90	3.500
2,60	.102	9,20	.362	17,90	.705	29,90	1.177	47,50	1.870	90,00	3.543
2,70	.106	9,30	.366	18,00	.709	30,00	1.181	47,80	1.882	91,44	3.600
2,80	.110	9,40	.370	18,10	.713	30,20	1.189	48,00	1.890	94,00	3.701
2,84	.112	9,50	.374	18,30	.721	30,40	1.197	48,10	1.894	95,00	3.740
2,90	.114	9,60	.378	18,60	.732	30,48	1.200	48,26	1.900	100,00	3.937
3,00	.118	9,70	.382	19,00	.748	30,50	1.201	48,80	1.921	110,00	4.331
3,10	.122	9,90	.390	19,20	.756	30,80	1.213	49,10	1.933	120,00	4.724
3,20	.126	10,00	.395								

TYPE B

Male connector – straight and angled – 32 and 64 positions

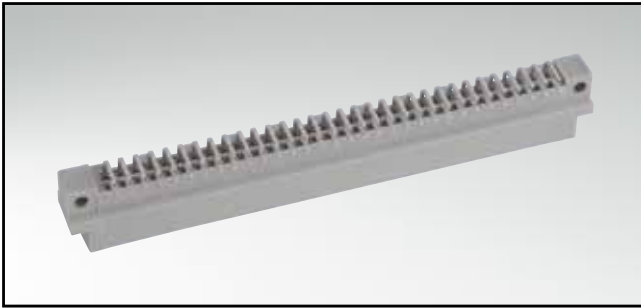

RoHS compliant

DESCRIPTION

- Solder pin
- Quality class 3 (also available in quality class 2 or 1)
- Premating contacts in row "a" und "b" available
- Special assembly on request

PRODUCT DRAWING

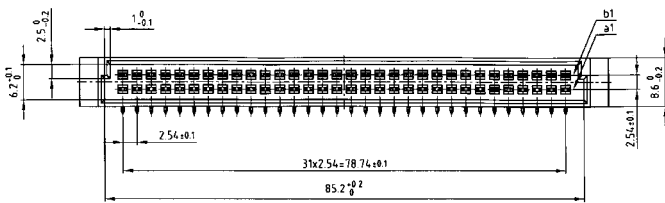

PCB-hole pattern

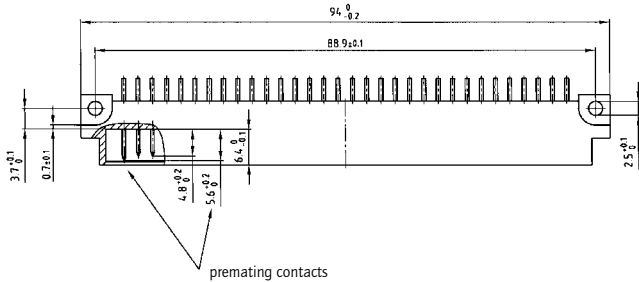
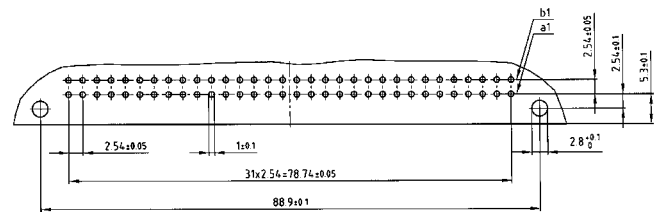

Solder pin angled

Solder pin straight

Solder pin angled with clip

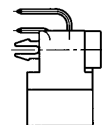
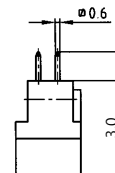
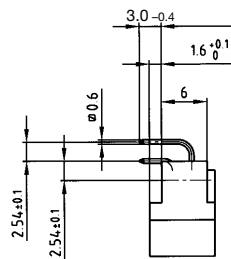

ORDER DATA

(Dim. = mm)

No. of Pos.	Row	• = contact, + = no contact						Solder pin angled	Solder pin straight	Solder pin angled with clip
		Pos..	1	2	3	4	5			
32	b		+	+	+	+	+	121 A 10019 X	121 A 10049 X	121 A 20819 X
	a		•	•	•	•	•			
32	b		+	•	+	•	+	121 A 10029 X	121 A 10059 X	121 A 20829 X
	a		+	•	+	•	+			
64	b		•	•	•	•	•	121 A 10039 X	121 A 10069 X	121 A 20839 X
	a		•	•	•	•	•			

Clip for hole diameter 2.8 + 0.1 mm, PCB thickness = 1.6 mm

TYPE B

Female connector – straight and angled – 32 and 64 positions

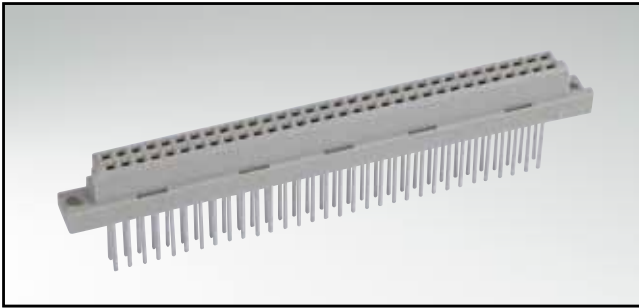

RoHS compliant

DESCRIPTION

- Solder pin, solder lug and wire wrap
- Quality class 3 (also available in quality class 2 or 1)
- Special assembly on request

PRODUCT DRAWING

PCB-hole pattern

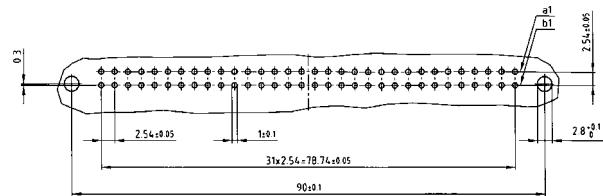
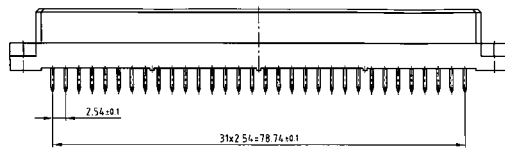

Panel cutout

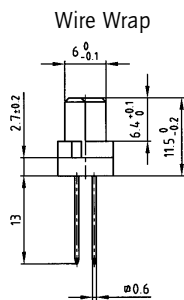
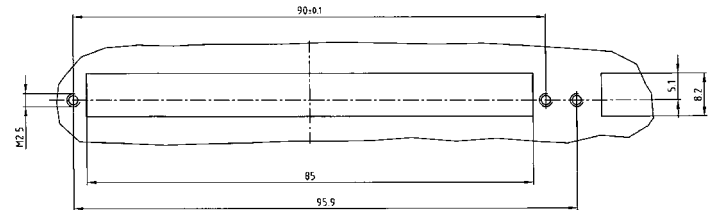
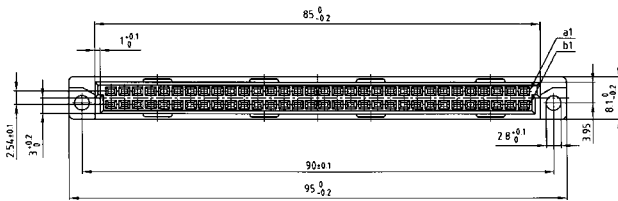

Wire Wrap

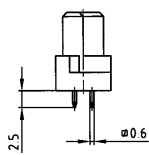

Solder pin straight 2.5 mm

Solder pin straight 4 mm

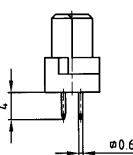

Solder lug

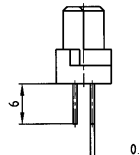

Solder pin angled

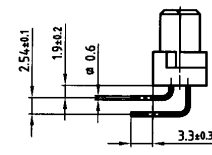

Solder pin straight 2.5 mm with clip

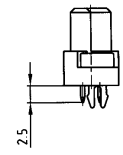

ORDER DATA

(Dim. = mm)

No. of Pos.	Row	• = contact, + = no contact					Wire Wrap	Solder pin straight 2.5 mm	Solder pin straight 4 mm	Solder lug	Solder pin angled	Solder pin straight 2.5 mm with clip	
		Pos.	1	2	3	4							5
32	a	•	•	•	•	•	122 A 10019 X	122 A 10049 X	122 A 10079 X	122 A 10109 X	122 A 10139 X	122 A 13189 X	
	b	+	+	+	+	+							
32	a	+	•	+	•	+	•	122 A 10029 X	122 A 10059 X	122 A 10089 X	122 A 10119 X	122 A 10149 X	122 A 13199 X
	b	+	•	+	•	+	•						
64	a	•	•	•	•	•	•	122 A 10039 X	122 A 10069 X	122 A 10099 X	122 A 10129 X	122 A 10159 X	122 A 13209 X
	b	•	•	•	•	•	•						

Clip for hole diameter 2.8 ± 0.1 mm, PCB thickness = 1.6 mm

TYPE B/2

Male connector – straight and angled – 16 and 32 positions

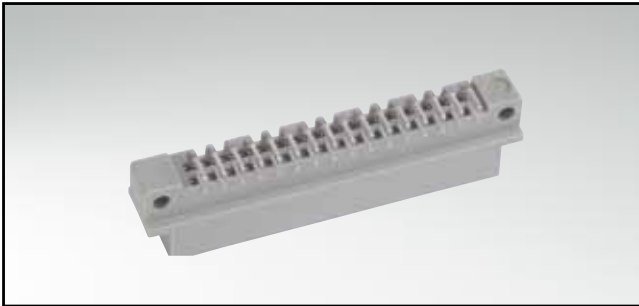

RoHS compliant

DESCRIPTION

- Solder pin
- Quality class 3 (also available in quality class 2 or 1)
- Premating contacts in row "a" und "b" available
- Special assembly on request

PRODUCT DRAWING

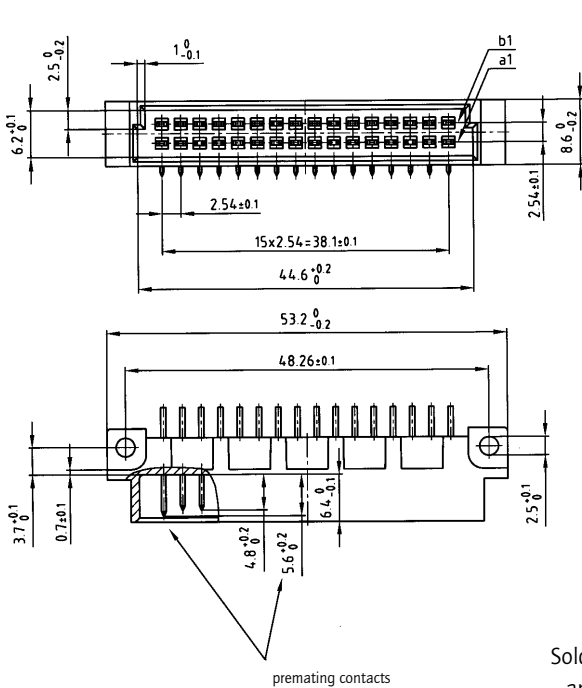

PCB-hole pattern

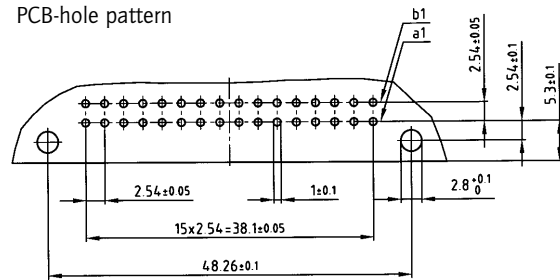

Solder pin angled

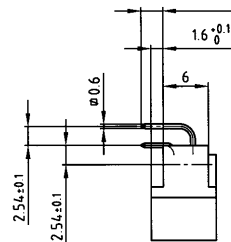

Solder pin straight

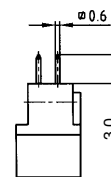

Solder pin angled with clip

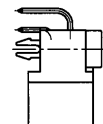

ORDER DATA

(Dim. = mm)

No. of Pos.	Row	• = contact, + = no contact						Solder pin angled	Solder pin straight	Solder pin angled with clip
		Pos. 1	2	3	4	5	...			
16	b	•	•	•	•	•	•	121 A 10259 X	121 A 10289 X	121 A 20849 X
	a	+	+	+	+	+	+			
16	b	+	•	+	•	+	•	121 A 10269 X	121 A 10299 X	121 A 20859 X
	a	+	•	+	•	+	•			
32	b	•	•	•	•	•	•	121 A 10279 X	121 A 10309 X	121 A 20869 X
	a	•	•	•	•	•	•			

Clip for hole diameter 2.8 + 0.1 mm, PCB thickness = 1.6 mm

TYPE B/2

Female connector – straight and angled – 16 and 32 positions

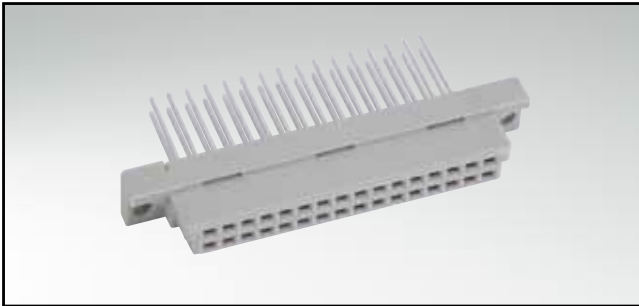

RoHS compliant

DESCRIPTION

- Solder pin, solder lug and wire wrap
- Quality class 3 (also available in quality class 2 or 1)
- Special assembly on request

PRODUCT DRAWING

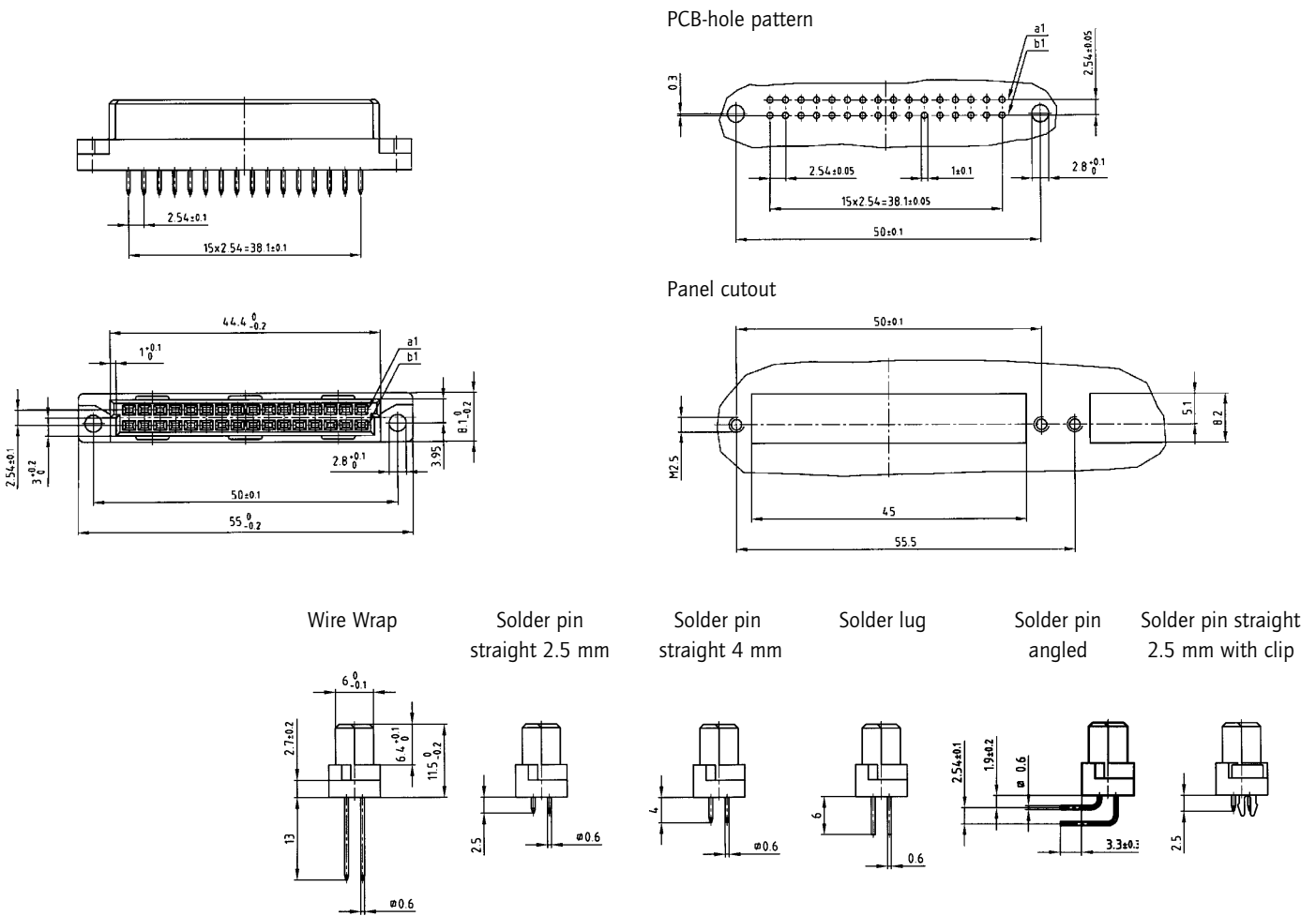

(Dim. = mm)

ORDER DATA

No. of Pos.	Row	• = contact, + = no contact					Wire Wrap	Solder pin straight 2.5 mm	Solder pin straight 4 mm	Solder lug	Solder pin angled	Solder pin straight 2.5 mm with clip
		Pos. 1	2	3	4	5 ...						
16	a	•	•	•	•	•	122 A 10419 X	122 A 10449 X	122 A 10479 X	122 A 10509 X	122 A 10539 X	122 A 13219 X
	b	+	+	+	+	+						
16	a	+	•	+	•	+	122 A 10429 X	122 A 10459 X	122 A 10489 X	122 A 10519 X	122 A 10549 X	122 A 13229 X
	b	+	•	+	•	+						
32	a	•	•	•	•	•	122 A 10439 X	122 A 10469 X	122 A 10499 X	122 A 10529 X	122 A 10559 X	122 A 13239 X
	b	•	•	•	•	•						

Clip for hole diameter 2.8 + 0.1 mm, PCB thickness = 1.6 mm

TYPE C

Male connector – straight and angled – 32, 64 and 96 positions



RoHS compliant

DESCRIPTION

- Solder pin
- Quality class 3 (also available in quality class 2 or 1)
- Premating contacts in row "a", "b" and "c" available
- Special assembly on request

PRODUCT DRAWING

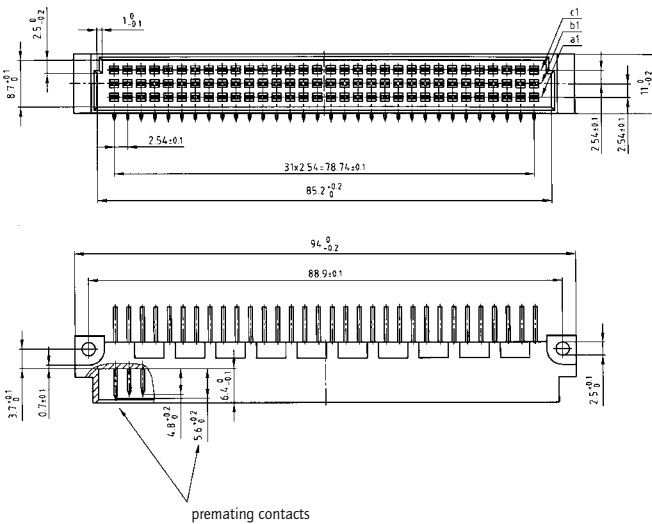

PCB-hole pattern

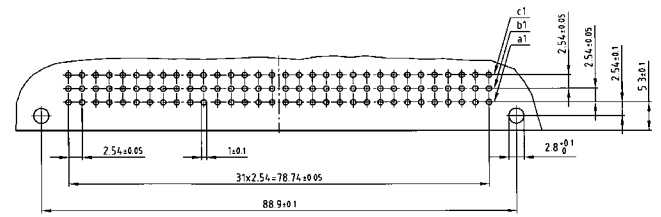

Solder pin angled

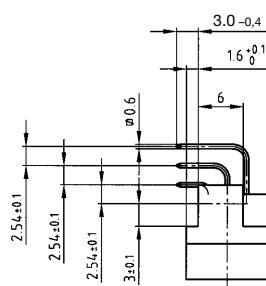

Solder pin straight

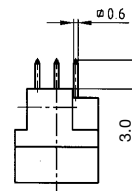

Solder pin angled with clip

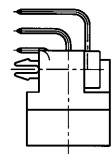

ORDER DATA

(Dim. = mm)

No. of Pos.	Row	• = contact, + = no contact						Solder pin angled	Solder pin straight	Solder pin angled with clip
		Pos.	1	2	3	4	5			
32	c		+	+	+	+	+	121 A 10109 X	121 A 10159 X	121 A 20879 X
	b		+	+	+	+	+			
	a		•	•	•	•	•			
32	c		+	•	+	•	+	121 A 10119 X	121 A 10169 X	121 A 20889 X
	b		+	+	+	+	+			
	a		+	•	+	•	+			
64	c		•	•	•	•	•	121 A 10139 X	121 A 10189 X	121 A 20909 X
	b		+	+	+	+	+			
	a		•	•	•	•	•			
96	c		•	•	•	•	•	121 A 10149 X	121 A 10199 X	121 A 20919 X
	b		•	•	•	•	•			
	a		•	•	•	•	•			

Clip for hole diameter 2.8 + 0.1 mm, PCB thickness = 1.6 mm

TYPE C

Female connector – straight and angled – 32, 64 and 96 positions

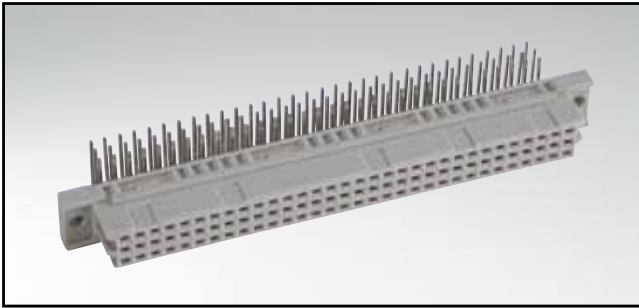

RoHS compliant

DESCRIPTION

- Solder pin, solder lug and wire wrap
- Quality class 3 (also available in quality class 2 or 1)
- Special assembly on request

PRODUCT DRAWING

PCB-hole pattern

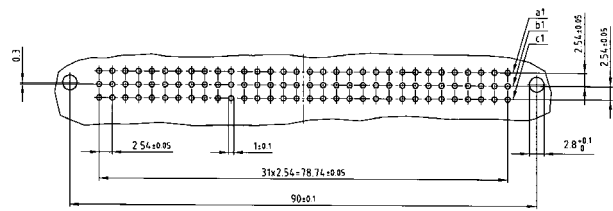
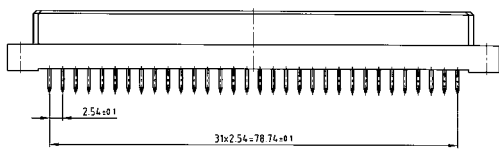

Panel cutout

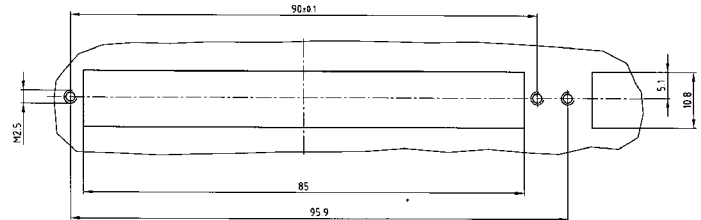
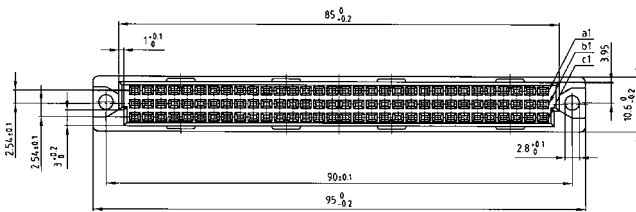

Wire Wrap

Solder pin straight 2.5 mm

Solder pin straight 4 mm

Solder lug

Solder pin angled

Solder pin straight 2.5 mm with clip

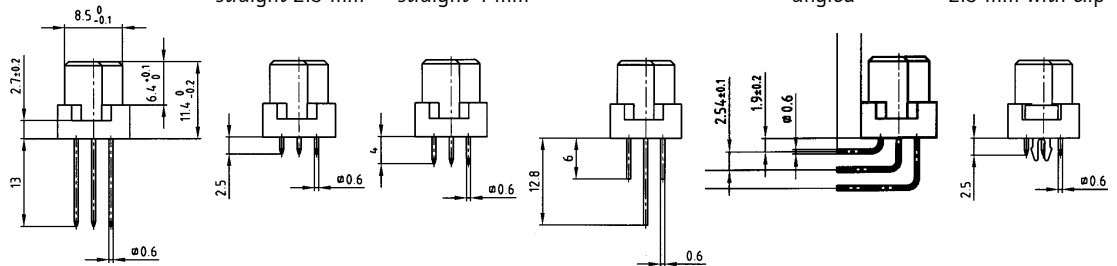

(Dim. = mm)

ORDER DATA

No. of Pos.	Row	• = contact, + = no contact					Wire Wrap	Solder pin straight 2.5 mm	Solder pin straight 4 mm	Solder lug	Solder pin angled	Solder pin straight 2,5 mm with clip
		Pos. 1	2	3	4	5						
32	a	•	•	•	•	•	122 A 10169 X	122 A 10219 X	122 A 10269 X	122 A 10319 X	122 A 10369 X	122 A 13249 X
	b	+	+	+	+	+						
	c	+	+	+	+	+						
32	a	•	•	•	•	•	122 A 10179 X	122 A 10229 X	122 A 10279 X	122 A 10329 X	122 A 10379 X	122 A 13259 X
	b	+	+	+	+	+						
	c	+	•	+	•	+						
64	a	•	•	•	•	•	122 A 10199 X	122 A 10249 X	122 A 10299 X	122 A 10349 X	122 A 10399 X	122 A 13279 X
	b	+	+	+	+	+						
	c	•	•	•	•	•						
96	a	•	•	•	•	•	122 A 10209 X	122 A 10259 X	122 A 10309 X	122 A 10359 X	122 A 10409 X	122 A 13289 X
	b	•	•	•	•	•						
	c	•	•	•	•	•						

Clip for hole diameter 2.8 + 0.1 mm, PCB thickness = 1.6 mm

TYPE C/2

Male connector – straight and angled – 16, 32 and 48 positions

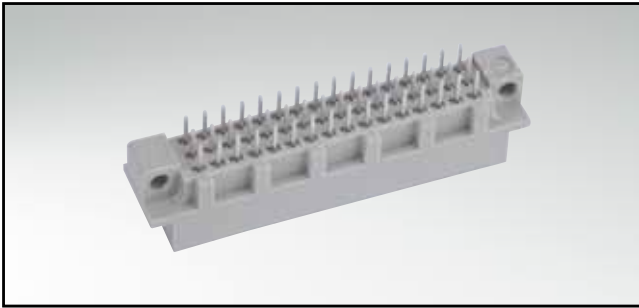

RoHS compliant

DESCRIPTION

- Solder pin
- Quality class 3 (also available in quality class 2 or 1)
- Premating contacts in row "a", "b" and "c" available
- Special assembly on request

PRODUCT DRAWING

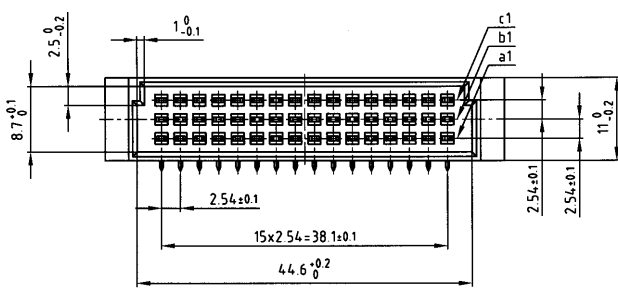

PCB-hole pattern

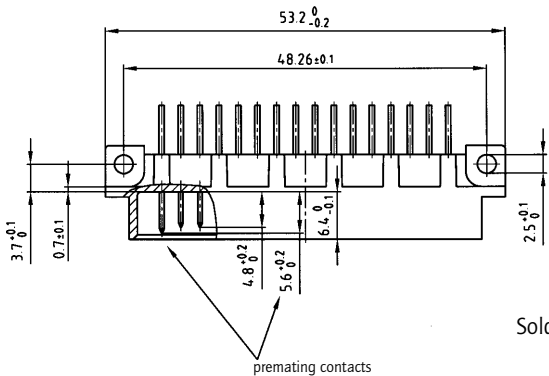
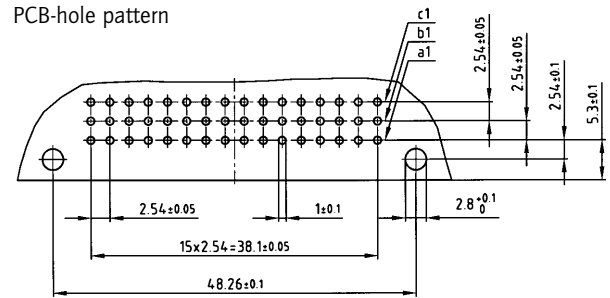

Solder pin angled

Solder pin straight

Solder pin angled with clip

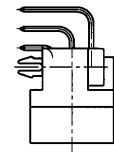
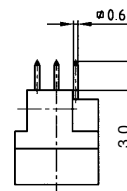
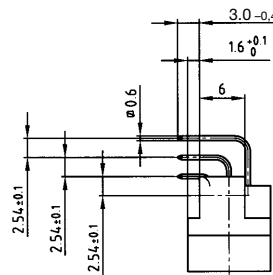

(Dim. = mm)

ORDER DATA

No. of Pos.	Row	• = contact, + = no contact						Solder pin angled	Solder pin straight	Solder pin angled with clip
		Pos.	1	2	3	4	5			
16	c		+	+	+	+	+	121 A 10349 X	121 A 10399 X	121 A 20929 X
	b		+	+	+	+	+			
	a		•	•	•	•	•			
16	c		+	•	•	•	•	121 A 10359 X	121 A 10409 X	121 A 20939 X
	b		+	+	+	+	+			
	a		+	•	•	•	•			
32	c		•	•	•	•	•	121 A 10379 X	121 A 10429 X	121 A 20959 X
	b		+	+	+	+	+			
	a		•	•	•	•	•			
48	c		•	•	•	•	•	121 A 10389 X	121 A 10439 X	121 A 20969 X
	b		•	•	•	•	•			
	a		•	•	•	•	•			

Clip for hole diameter 2.8 + 0.1 mm, PCB thickness = 1.6 mm

TYPE C/2

Female connector – straight and angled – 16, 32 and 48 positions

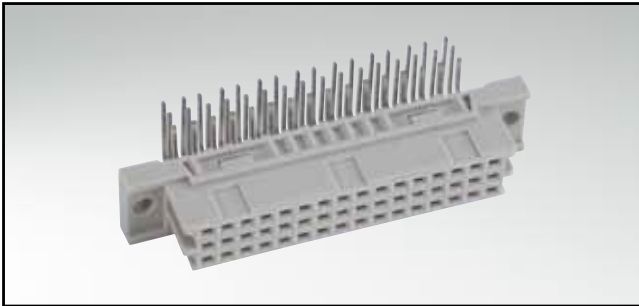

RoHS compliant

DESCRIPTION

- Solder pin, solder lug and wire wrap
- Quality class 3 (also available in quality class 2 or 1)
- Special assembly on request

PRODUCT DRAWING

PCB-hole pattern

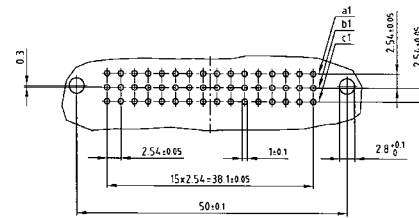

Panel cutout

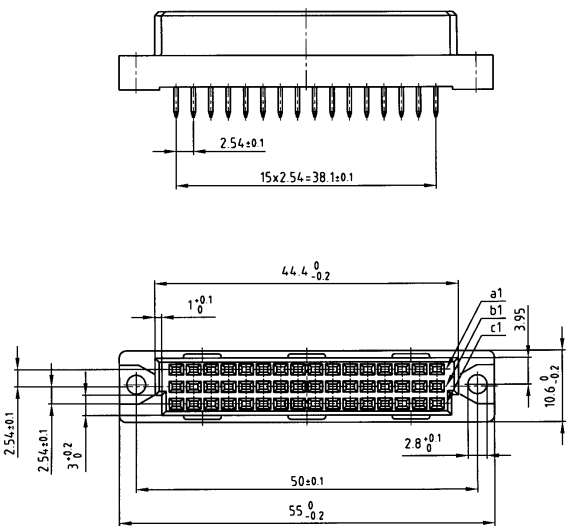
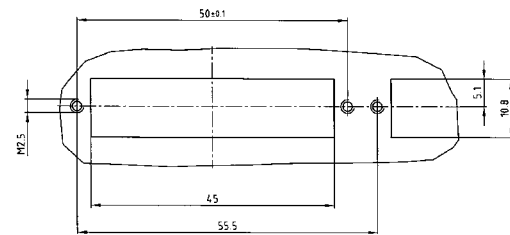

Wire Wrap

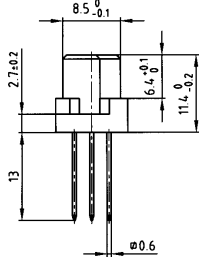

Solder pin straight 2.5 mm

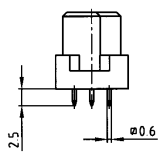

Solder pin straight 4 mm

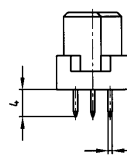

Solder lug

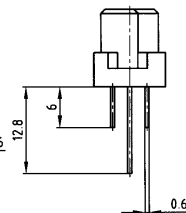

Solder pin angled

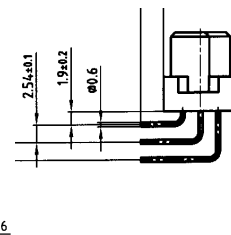

Solder pin straight 2.5 mm with clip

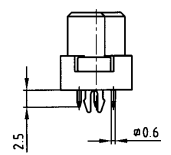

ORDER DATA

(Dim. = mm)

No. of Pos.	Row	• = contact, + = no contact					Wire Wrap	Solder pin straight 2.5 mm	Solder pin straight 4 mm	Solder lug	Solder pin angled	Solder pin straight 2,5 mm with clip
		Pos.	1	2	3	4						
16	a		•	•	•	•						
	b	+	+	+	+	+	122 A 10579 X	122 A 10629 X	122 A 10679 X	122 A 10729 X	122 A 10779 X	122 A 13299 X
	c	+	+	+	+	+						
16	a		•	•	•	•						
	b	+	+	+	+	+	122 A 10589 X	122 A 10639 X	122 A 10689 X	122 A 10739 X	122 A 10789 X	122 A 13309 X
	c	+	•	•	•	•						
32	a		•	•	•	•						
	b	+	+	+	+	+	122 A 10609 X	122 A 10659 X	122 A 10709 X	122 A 10759 X	122 A 10809 X	122 A 13329 X
	c		•	•	•	•						
48	a		•	•	•	•						
	b		•	•	•	•	122 A 10619 X	122 A 10669 X	122 A 10719 X	122 A 10769 X	122 A 10819 X	122 A 13339 X
	c		•	•	•	•						

Clip for hole diameter 2.8 + 0.1 mm, PCB thickness = 1.6 mm

TYPE R

Male connector – straight – 32, 64 and 96 positions

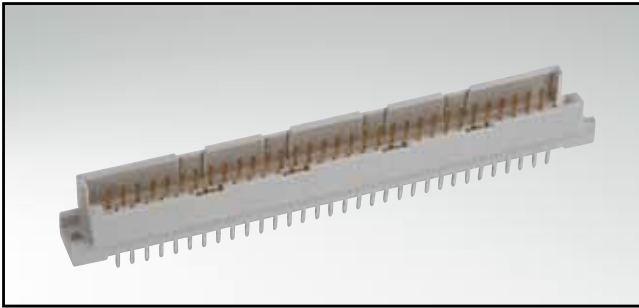

RoHS compliant

DESCRIPTION

- Solder pin and wire wrap
- Quality class 3 (also available in quality class 2 or 1)

PRODUCT DRAWING

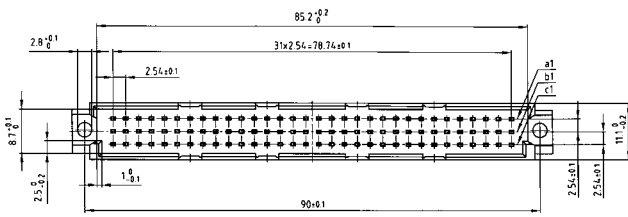

PCB-hole pattern

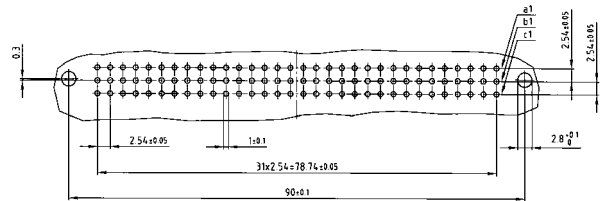

Panel cutout

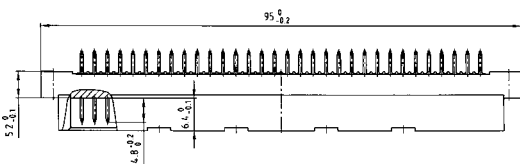
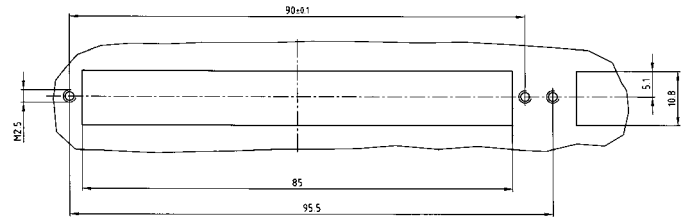

Wire Wrap

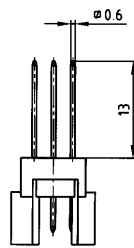

Solder pin straight

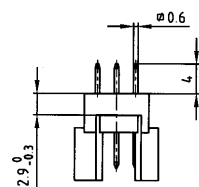

ORDER DATA

(Dim. = mm)

No. of Pos.	Row	• = contact, + = no contact					Wire Wrap	Solder pin straight		
		Pos.	1	2	3	4			5	...
32	a		+	•	+	•	+	•	121 A 10509 X	121 A 10549 X
	b		+	+	+	+	+	+		
	c		+	•	+	•	+	•		
64	a		•	•	•	•	•	•	121 A 10519 X	121 A 10559 X
	b		+	+	+	+	+	+		
	c		•	•	•	•	•	•		
96	a		•	•	•	•	•	•	121 A 10529 X	121 A 10569 X
	b		•	•	•	•	•	•		
	c		•	•	•	•	•	•		

TYPE R

Female connector – angled – 32, 64 and 96 positions

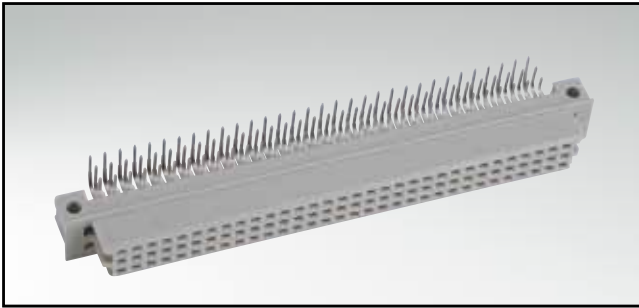

RoHS compliant

DESCRIPTION

- Solder pin
- Quality class 3 (also available in quality class 2 or 1)

PRODUCT DRAWING

PCB-hole pattern

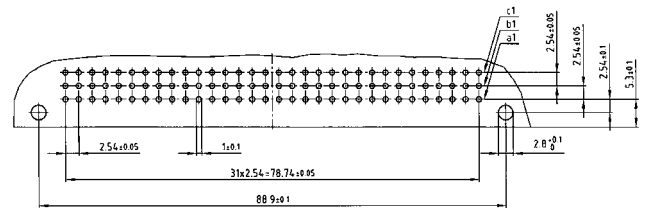
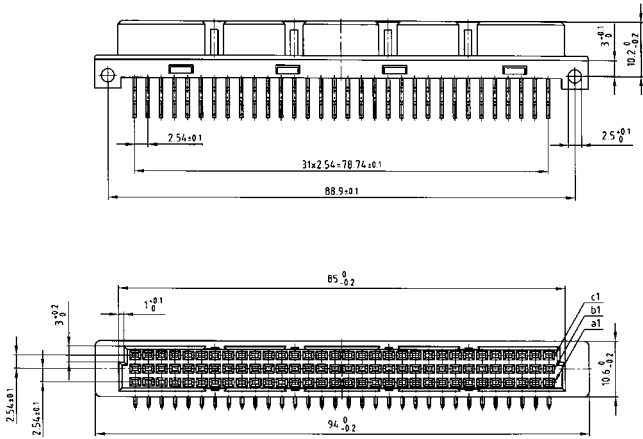

Solder pin angled

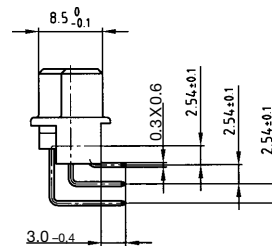

ORDER DATA

(Dim. = mm)

No. of Pos.	Row	• = contact, + = no contact						Solder pin angled
		Pos.	1	2	3	4	5	
32	c		+	•	+	•	+	122 A 10839 X
	b		+	+	+	+	+	
	a		+	•	+	•	+	
64	c		•	•	•	•	•	122 A 10849 X
	b		+	+	+	+	+	
	a		•	•	•	•	•	
96	c		•	•	•	•	•	122 A 10859 X
	b		•	•	•	•	•	
	a		•	•	•	•	•	

TYPE R/2

Male connector – straight – 32 and 48 positions

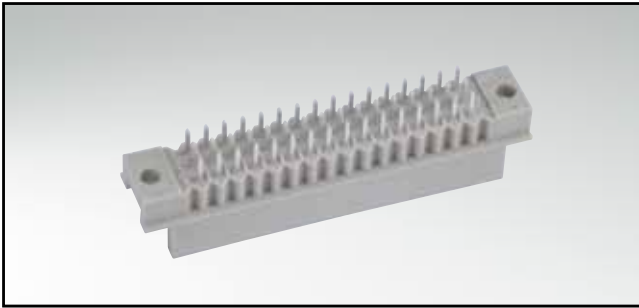

RoHS compliant

DESCRIPTION

- Solder pin and wire wrap
- Quality class 3 (also available in quality class 2 or 1)

PRODUCT DRAWING

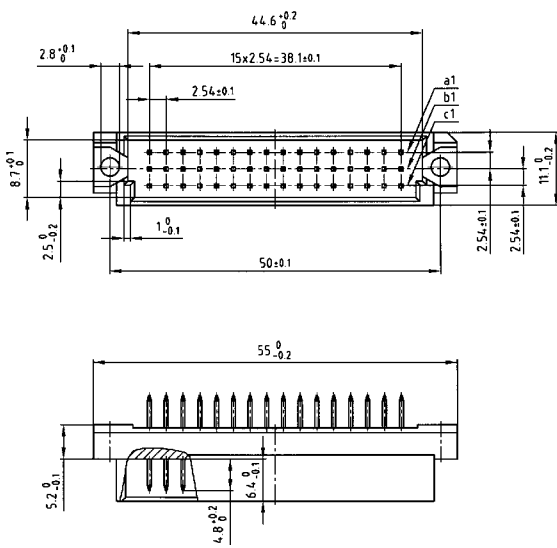

PCB-hole pattern

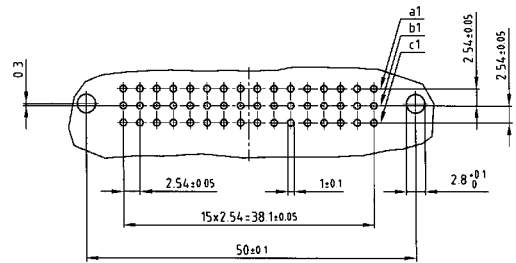

Panel cutout

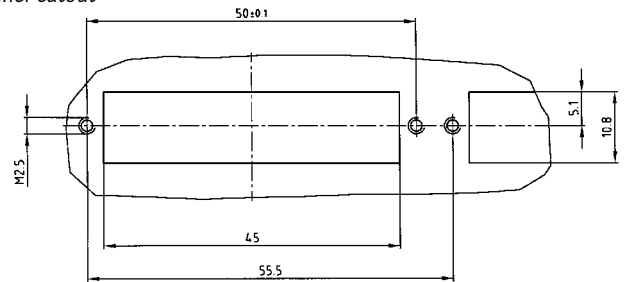

Wire Wrap

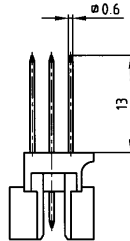

Solder pin straight

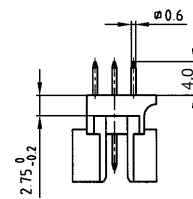

ORDER DATA

(Dim. = mm)

No. of Pos.	Row	• = contact, + = no contact						Wire Wrap	Solder pin straight
		Pos.	1	2	3	4	5		
32	a		•	•	•	•	•	121 A 10589 X	121 A 10619 X
	b	+	+	+	+	+	+		
	c	•	•	•	•	•	•		
48	a		•	•	•	•	•	121 A 10599 X	121 A 10629 X
	b		•	•	•	•	•		
	c		•	•	•	•	•		

TYPE R/2

Female connector – angled – 32 and 48 positions

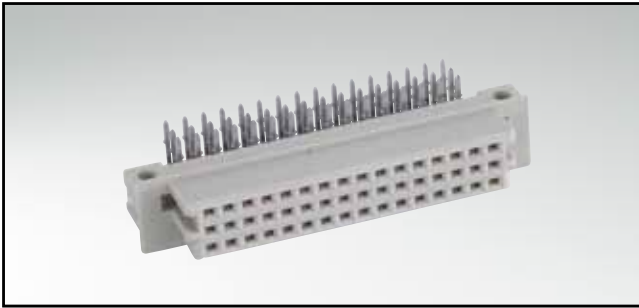

RoHS compliant

DESCRIPTION

- Solder pin
- Quality class 3 (also available in quality class 2 or 1)

PRODUCT DRAWING

PCB-hole pattern

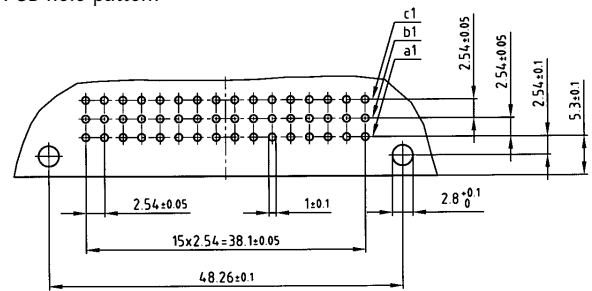
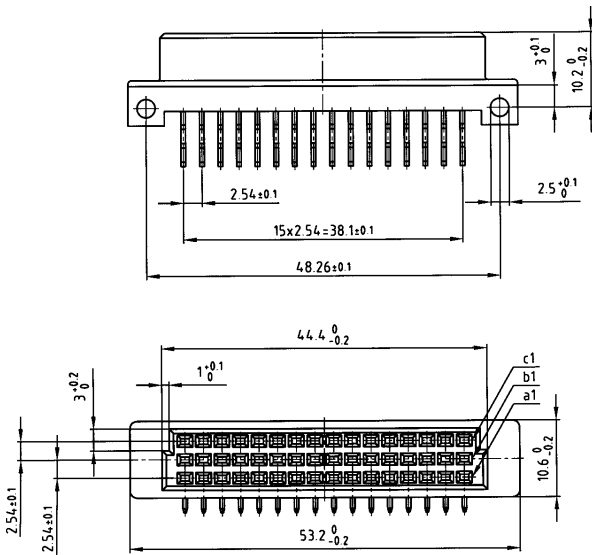

Solder pin angled

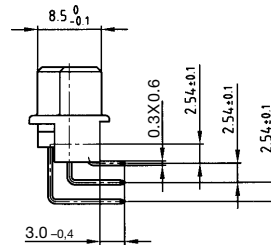

(Dim. = mm)

ORDER DATA

No. of Pos.	Row	• = contact, + = no contact						Solder pin angled
		Pos.	1	2	3	4	5	
32	c		•	•	•	•	•	122 A 10879 X
	b	+	+	+	+	+	+	
	a	•	•	•	•	•	•	
48	c		•	•	•	•	•	122 A 10889 X
	b		•	•	•	•	•	
	a		•	•	•	•	•	

TYPE D

Male connector – straight and angled – 16 and 32 positions

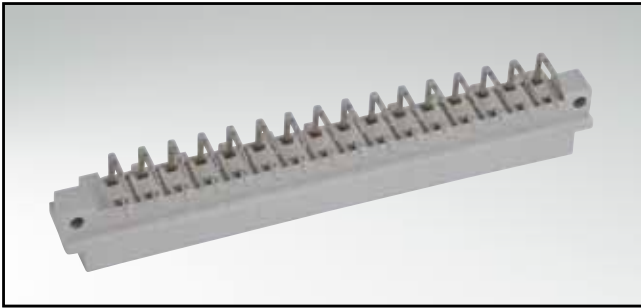

RoHS compliant

DESCRIPTION

- Solder pin
- Quality class 3 (also available in quality class 2 or 1)
- premating contacts in row "a" available
- Special assembly on request

PRODUCT DRAWING

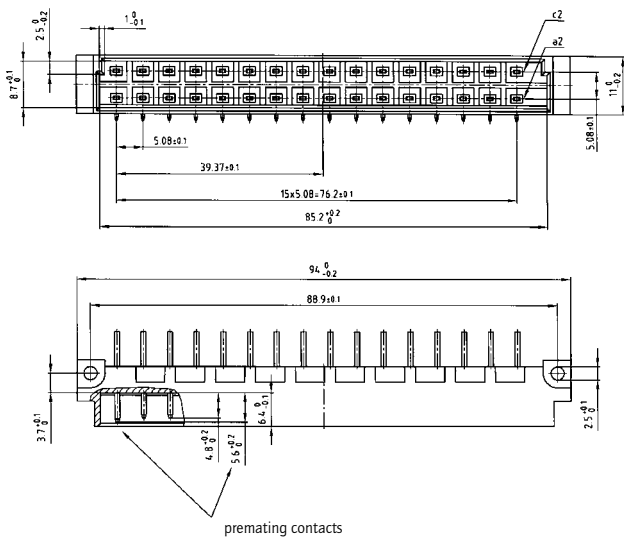

PCB-hole pattern

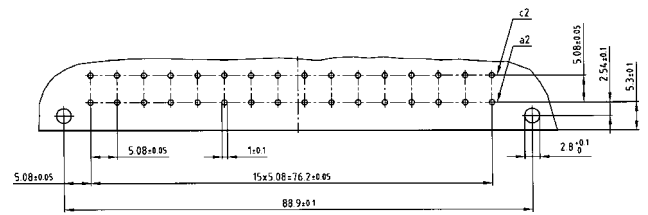

Solder pin angled

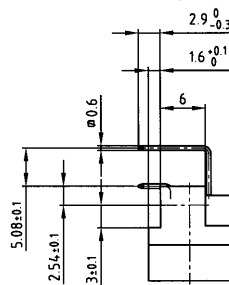

Solder pin straight

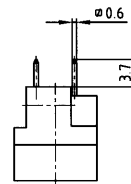

Solder pin angled with clip

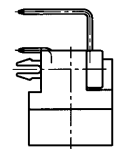

ORDER DATA

(Dim. = mm)

No. of Pos.	Row	• = contact, + = no contact				Solder pin angled	Solder pin straight	Solder pin angled with clip
		Pos.	2	4	6			
16	c		•	+	•	121 A 10639 X	121 A 10659 X	121 A 20979 X
	a		•	+	•			
32	c		•	•	•	121 A 10649 X	121 A 10669 X	121 A 20989 X
	a		•	•	•			

Clip for hole diameter 2.8 + 0.1 mm, PCB thickness = 1.6 mm

TYPE D

Female connector – straight – 16 and 32 positions

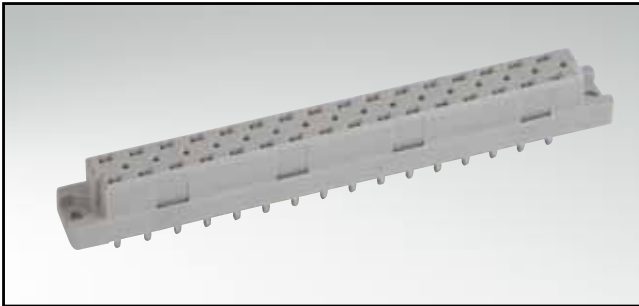

RoHS compliant

DESCRIPTION

- Solder pin, wire wrap and solder lug
- Quality class 3 (also available in quality class 2 or 1)
- Special assembly on request

PRODUCT DRAWING

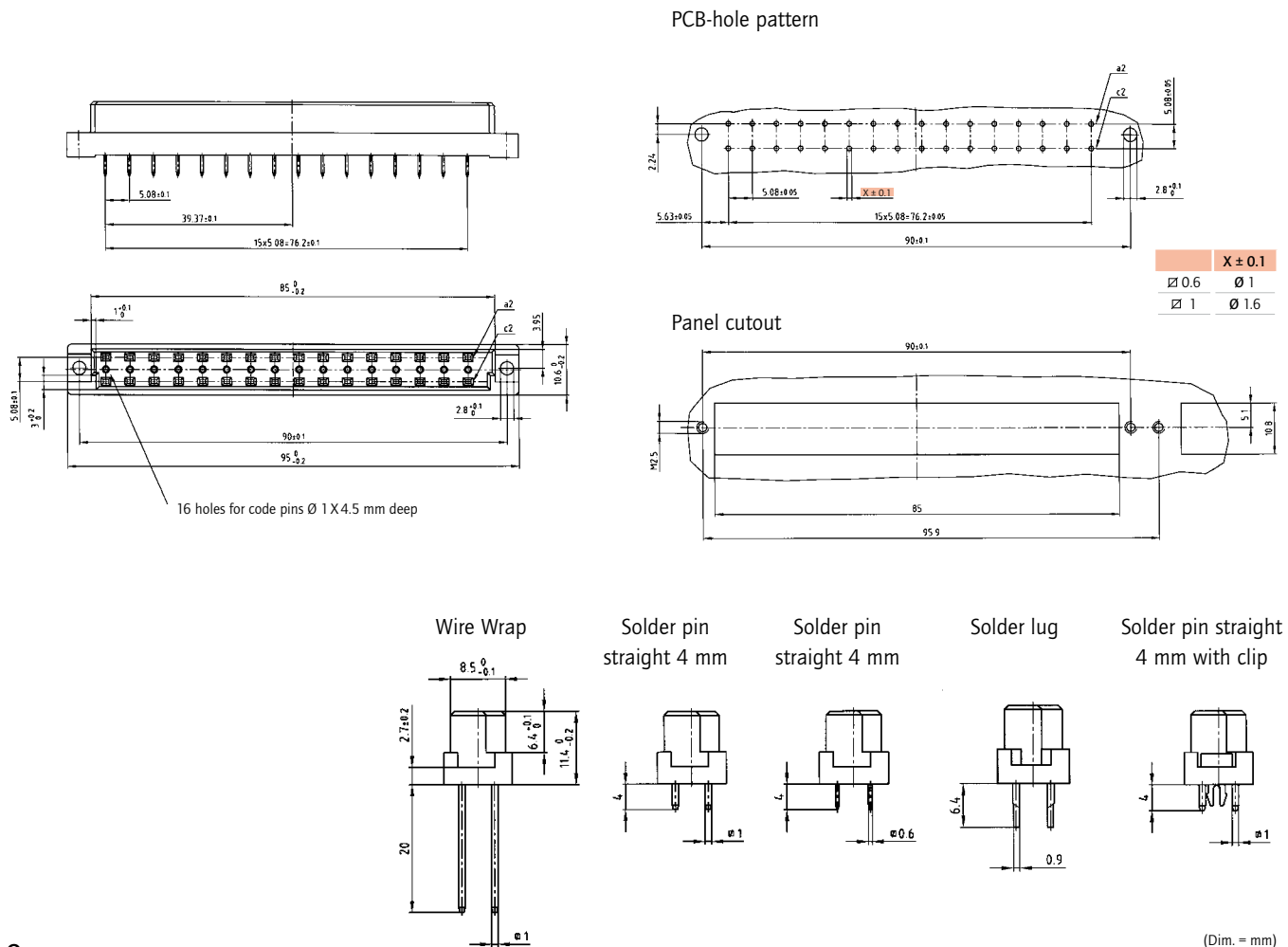

ORDER DATA

No. of Pos.	Row	• = contact, + = no contact				Wire Wrap	Solder pin straight 4.0 mm $\varnothing 1$ mm	Solder pin straight 4.0 mm $\varnothing 0.6$ mm	Solder lug	Solder pin straight 4mm $\varnothing 1$ mm w. clip	
		Pos.	2	4	6						...
16	a		•	+	•	+	122 A 10919 X	122 A 10939 X	122 A 13079 X	122 A 10959 X	122 A 13349 X
	c		•	+	•	+					
32	a		•	•	•	•	122 A 10929 X	122 A 10949 X	122 A 13089 X	122 A 10969 X	122 A 13359 X
	c		•	•	•	•					

Clip for hole diameter 2.8 ± 0.1 mm, PCB thickness = 1.6 mm

TYPE D WITH SCREW TERMINATION

Female connector – straight – 32 positions

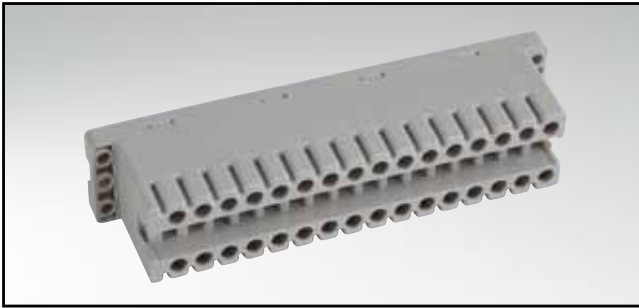

RoHS compliant

TECHNICAL DATA

Conductor size:	AWG 24 to 16
Operating voltage:	6 A
Rated voltage:	300 / 250 V~
Insulator:	PBT GF grey
Operating temperature:	-55°C to +120°C
Flammability:	UL 94 V-0
Material:	Copper alloy
Contact plating:	Quality class 2
Screw connection:	Steel

PRODUCT DRAWING

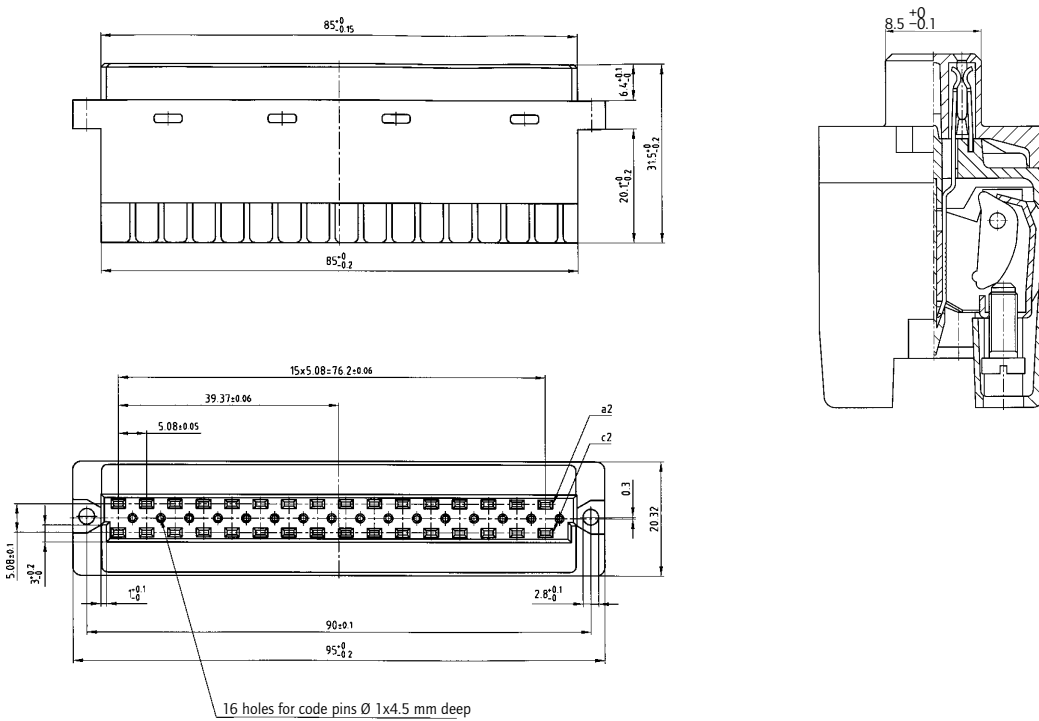

ORDER DATA

(Dim. = mm)

No. of Pos.	Row	Female connector	Latches with strain relief angled	Latches without strain relief straight
32	c a	122 B 13029 X	12-500600	12-500590

TYPE E

Male connector – angled – 32 and 48 positions

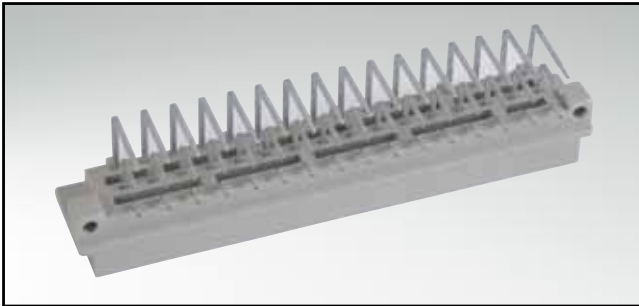

RoHS compliant

DESCRIPTION

- Solder pin
- Quality class 3 (also available in quality class 2 or 1)

PRODUCT DRAWING

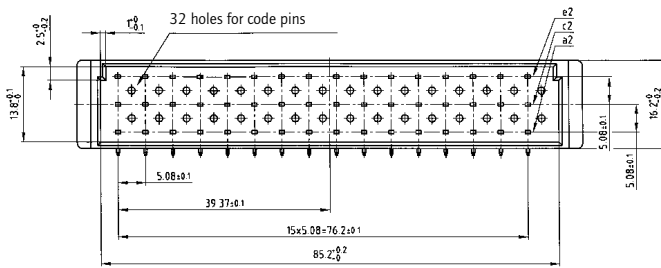

PCB-hole pattern

Solder pin angled 5.08 mm

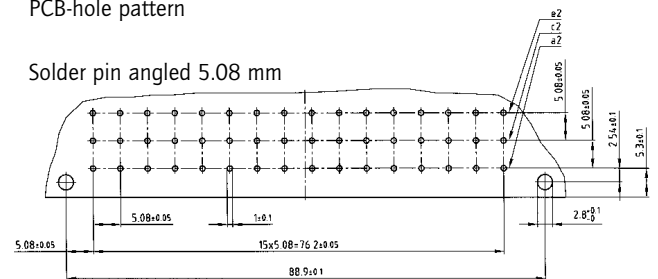

Solder pin angled 2.54 mm

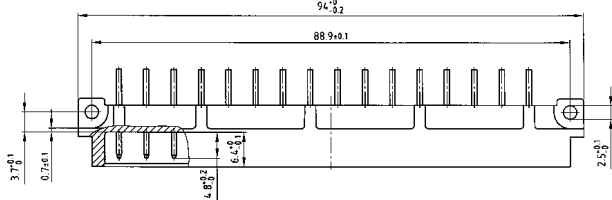
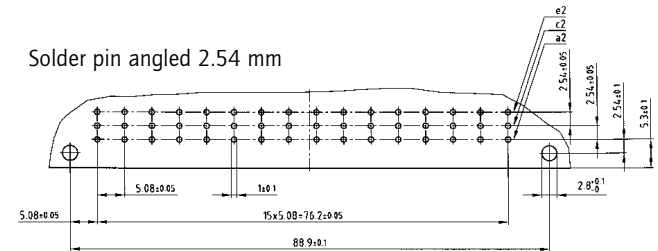

Solder pin angled contact spacing 5.08 mm

Solder pin angled contact spacing 2.54 mm

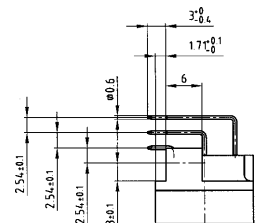
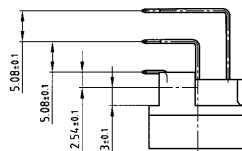

ORDER DATA

(Dim. = mm)

No. of Pos.	Row	• = contact, + = no contact				Solder pin angled contact spacing 5.08 mm	Solder pin angled contact spacing 2.54 mm
		Pos.	2	4	6 ...		
32	e		+	+	+	121 A 20789 X	121 A 20779 X
	c		•	•	•		
	a		•	•	•		
32	e		•	•	•	121 A 20809 X	121 A 20799 X
	c		+	+	+		
	a		•	•	•		
48	e		•	•	•	121 A 10859 X	121 A 10849 X
	c		•	•	•		
	a		•	•	•		

TYPE E

Female connector – straight – 32 and 48 positions

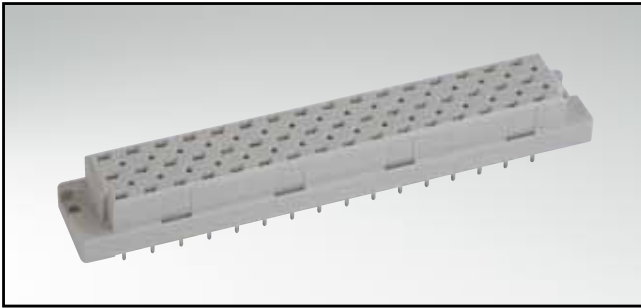

RoHS compliant

DESCRIPTION

- Solder pin, wire wrap and solder lug
- Quality class 3 (also available in quality class 2 or 1)
- Special assembly on request

PRODUCT DRAWING

PCB-hole pattern

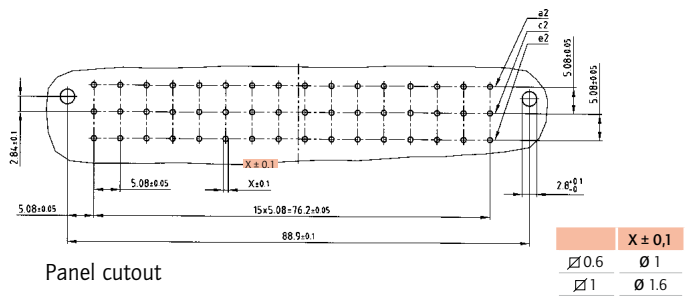

Panel cutout

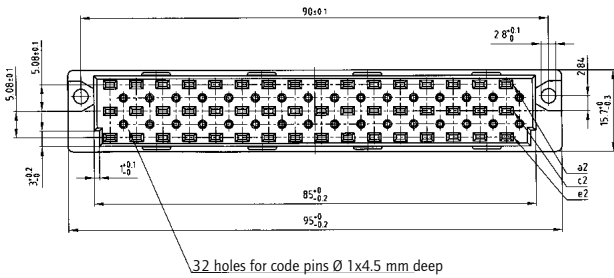
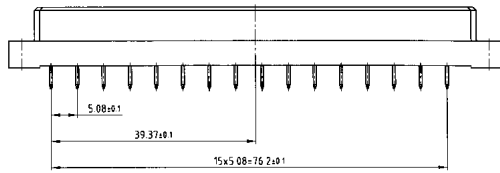
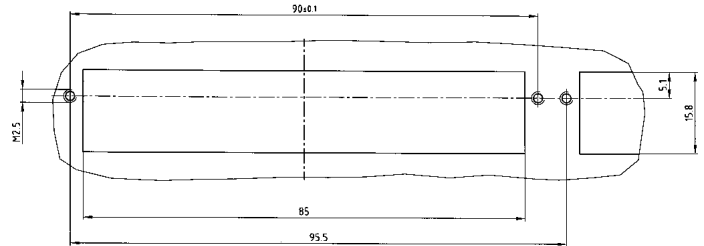

Solder pin straight 4.6 mm

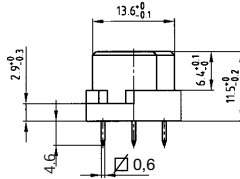

Solder pin straight 4 mm

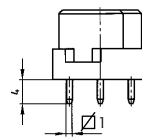

Solder lug

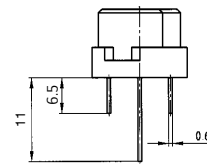

Wire Wrap

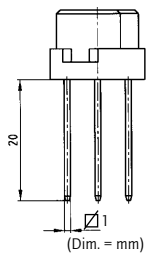

ORDER DATA

No. of Pos.	Row	• = contact, + = no contact				Solder pin straight 4.6 mm $\varnothing 0.6$ mm	Solder pin straight 4.0 mm $\varnothing 1$ mm	Solder lug	Wire Wrap	
		Pos.	2	4	6					...
32	a		•	•	•	•	122 A 13099 X	122 A 13129 X	122 A 13149 X	122 A 13169 X
	c		•	•	•	•				
	e		+	+	+	+				
32	a		•	•	•	•	122 A 13109 X	122 A 13139 X	122 A 13159 X	122 A 13179 X
	c		+	+	+	+				
	e		•	•	•	•				
48	a		•	•	•	•	122 A 13119 X	122 A 11619 X	122 A 11629 X	122 A 11609 X
	c		•	•	•	•				
	e		•	•	•	•				

TYPE F

Male connector – straight and angled – 32 and 48 positions

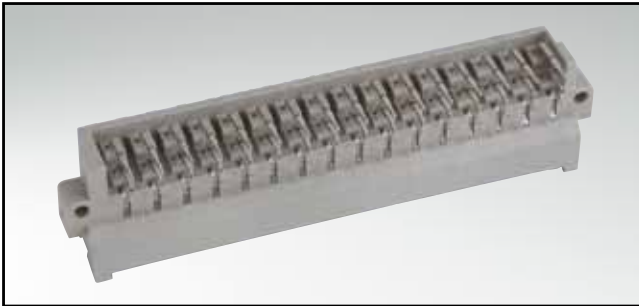

RoHS compliant

DESCRIPTION

- Solder pin
- Quality class 3 (also available in quality class 2 or 1)
- Premating contacts in row "z", "b" and "d" available
- Special assembly on request

PRODUCT DRAWING

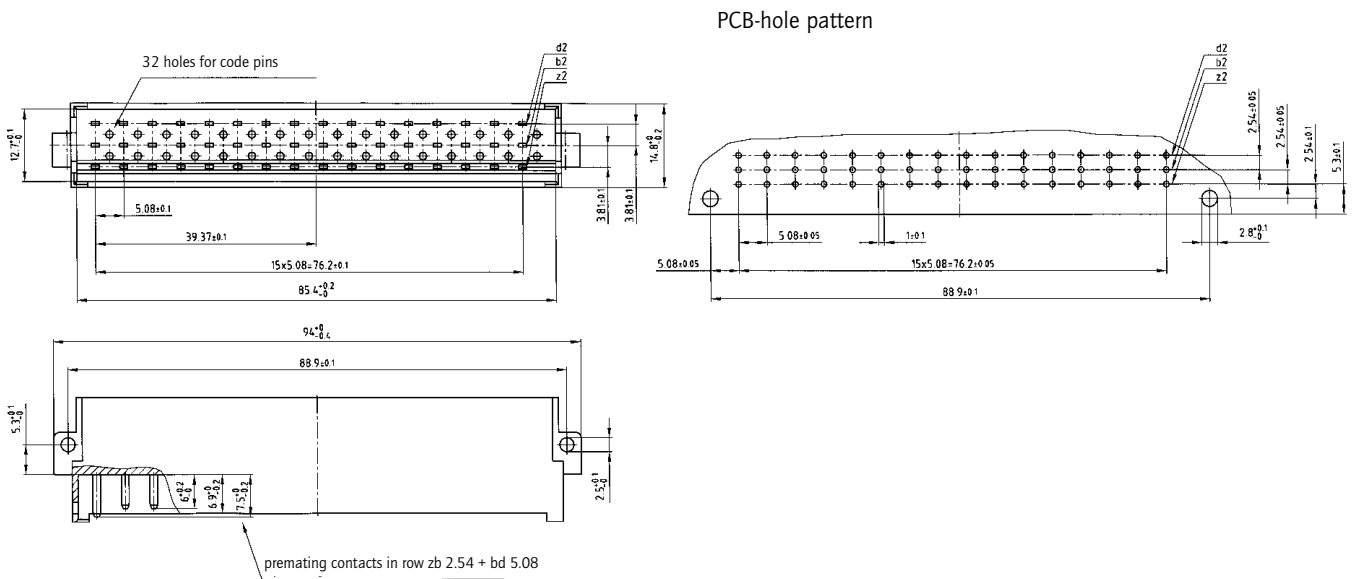

Solder pin angled contact spacing 5.08 mm

Solder pin angled contact spacing 2.54 mm

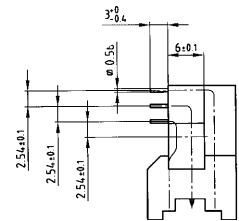
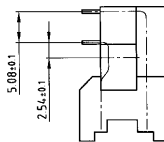

ORDER DATA

(Dim. = mm)

No. of Pos.	Row	• = contact, + = no contact				Contact spacing	Solder pin angled
		Pos.	2	4	6		
32	d		+	+	+	2.54 mm	121 A 10699 X
	b		•	•	•		
	z		•	•	•		
32	d		•	•	•	5.08 mm	121 A 10709 X
	b		+	+	+		
	z		•	•	•		
48	d		•	•	•	2.54 mm	121 A 10719 X
	b		•	•	•		
	z		•	•	•		

TYPE F

Female connector – straight – 32 and 48 positions

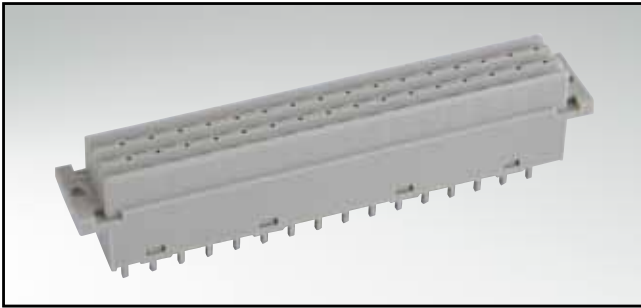

RoHS compliant

DESCRIPTION

- Solder pin, wire wrap and solder lug
- Quality class 3 (also available in quality class 2 or 1)
- Special assembly on request

PRODUCT DRAWING

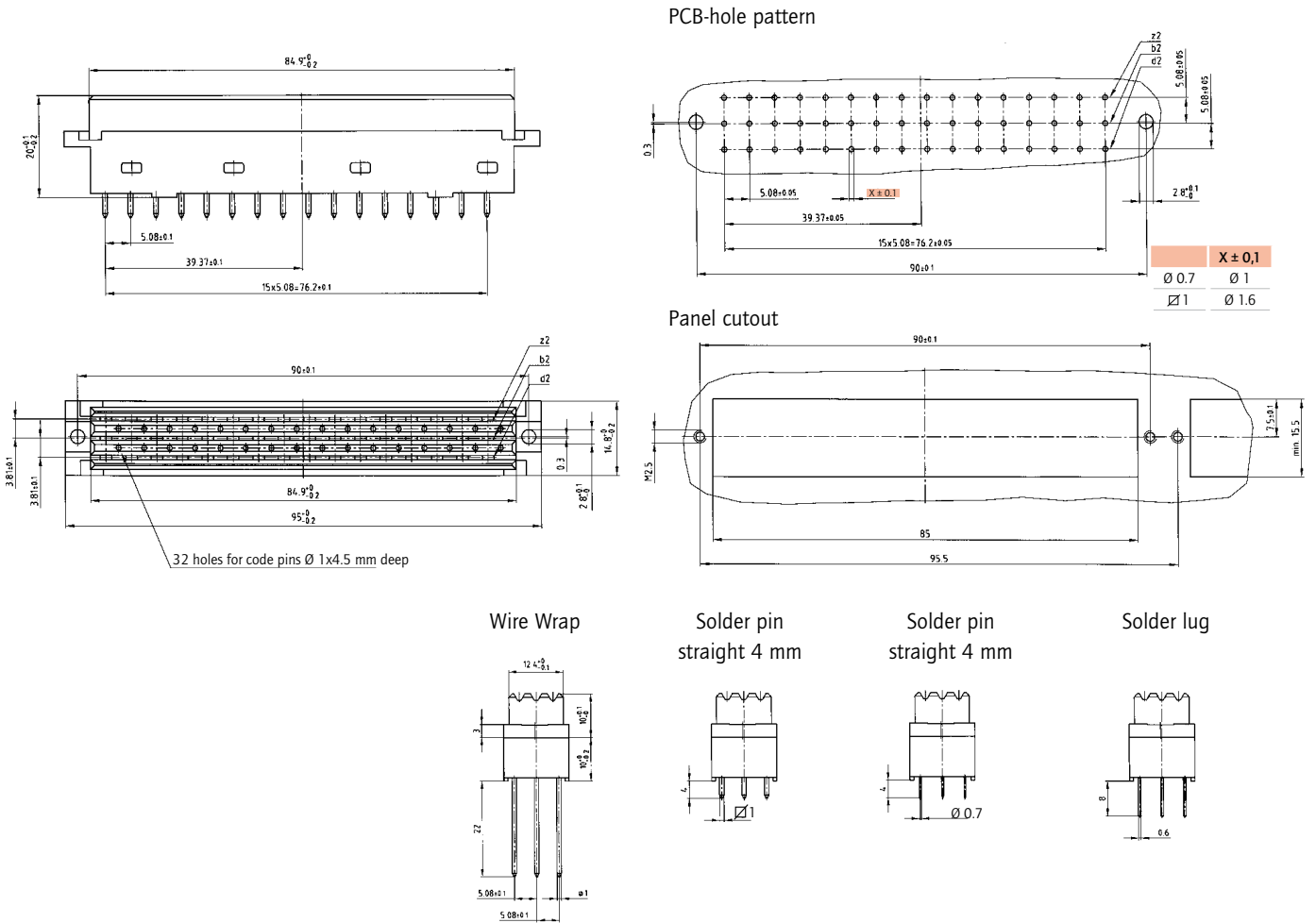

ORDER DATA

(Dim. = mm)

No. of Pos.	Row	• = contact, + = no contact				Wire Wrap	Solder pin straight ∅ 1 mm	Solder pin straight ∅ 0.7 mm	Solder lug
		Pos.	2	4	6				
32	z		•	•	•	•			
	b		•	•	•	•			
	d		+	+	+	+			
32	z		•	•	•	•			
	b		+	+	+	+			
	d		•	•	•	•			
48	z		•	•	•	•			
	b		•	•	•	•			
	d		•	•	•	•			

LOW PROFILE TYPE F

Female connector – straight – 32 and 48 positions

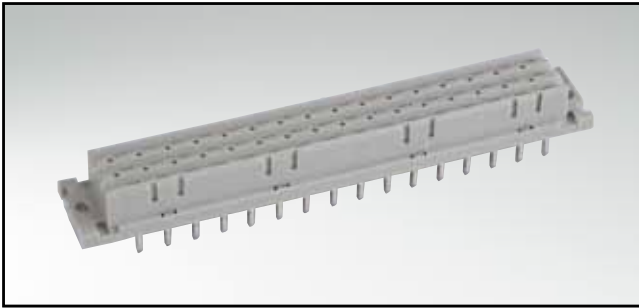

RoHS compliant

DESCRIPTION

- Solder pin
- Quality class 2 (other quality classes on request)

PRODUCT DRAWING

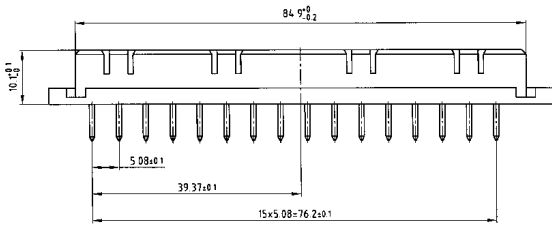

PCB-hole pattern

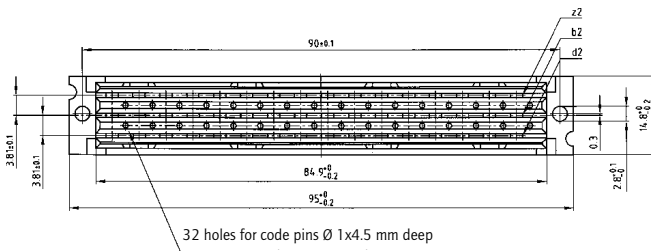
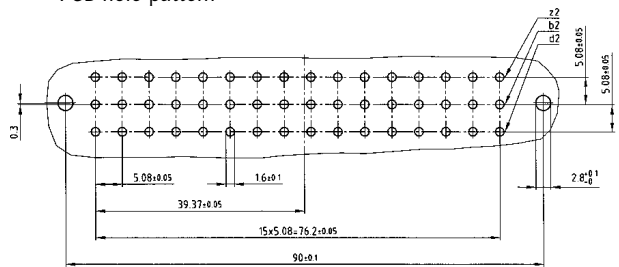

Panel cutout

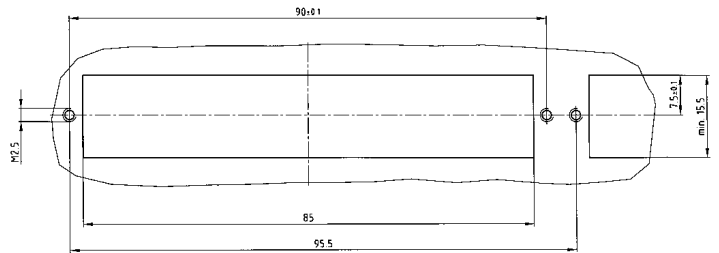

Solder pin straight

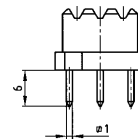

ORDER DATA

(Dim. = mm)

No. of Pos.	Row	• = contact, + = no contact				Solder pin straight
		Pos.	2	4	6	
32	z		•	•	•	122 B 11739 X
	b		•	•	•	
	d	+	+	+	+	
32	z		•	•	•	122 B 11749 X
	b	+	+	+	+	
	d	•	•	•	•	
48	z		•	•	•	122 B 11759 X
	b		•	•	•	
	d		•	•	•	

TYPE G

Male connector – angled – 64 positions

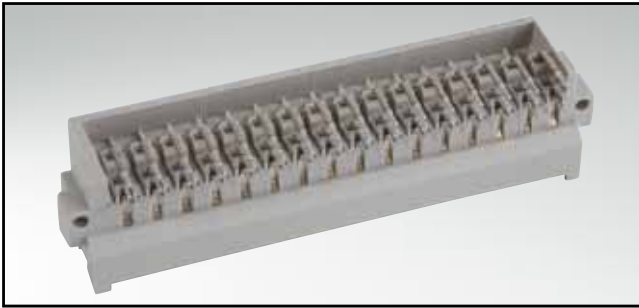

RoHS compliant

DESCRIPTION

- Solder pin
- Quality class 3 (also available in quality class 2 or 1)
- Premating contacts in row "z", "b" and "d" available
- Special assembly on request

PRODUCT DRAWING

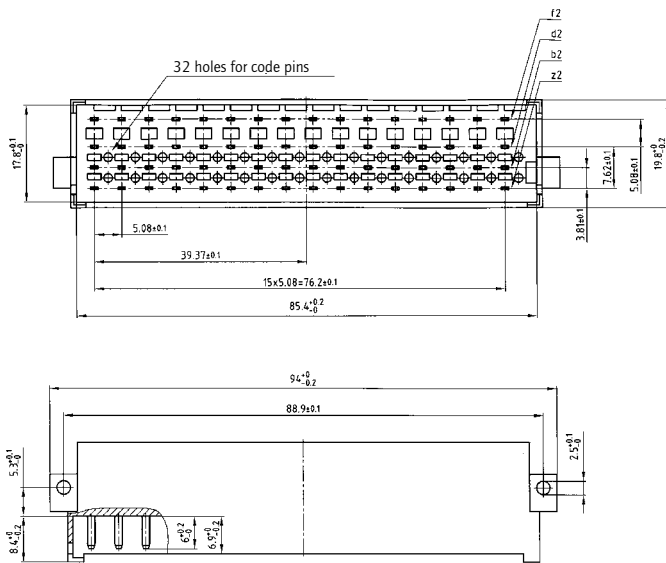

PCB-hole pattern

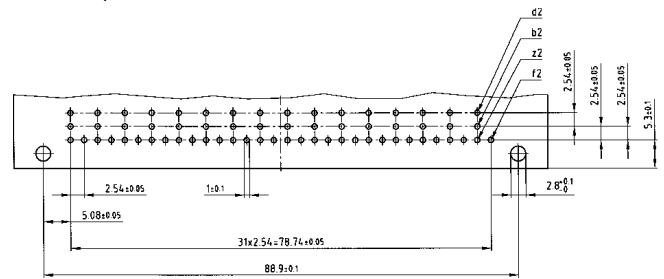

Solder pin angled Cross section

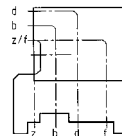

Solder pin angled

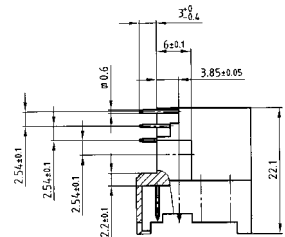

ORDER DATA

(Dim. = mm)

No. of Pos.	Row	Solder pin angled
64	f	121 A 10789 X
	d	
	b	
	z	

TYPE G

Female connector – straight – 64 positions

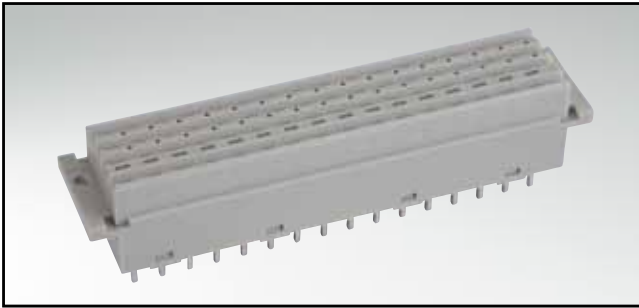

RoHS compliant

DESCRIPTION

- Solder pin and wire wrap
- Quality class 3 (also available in quality class 2 or 1)

PRODUCT DRAWING

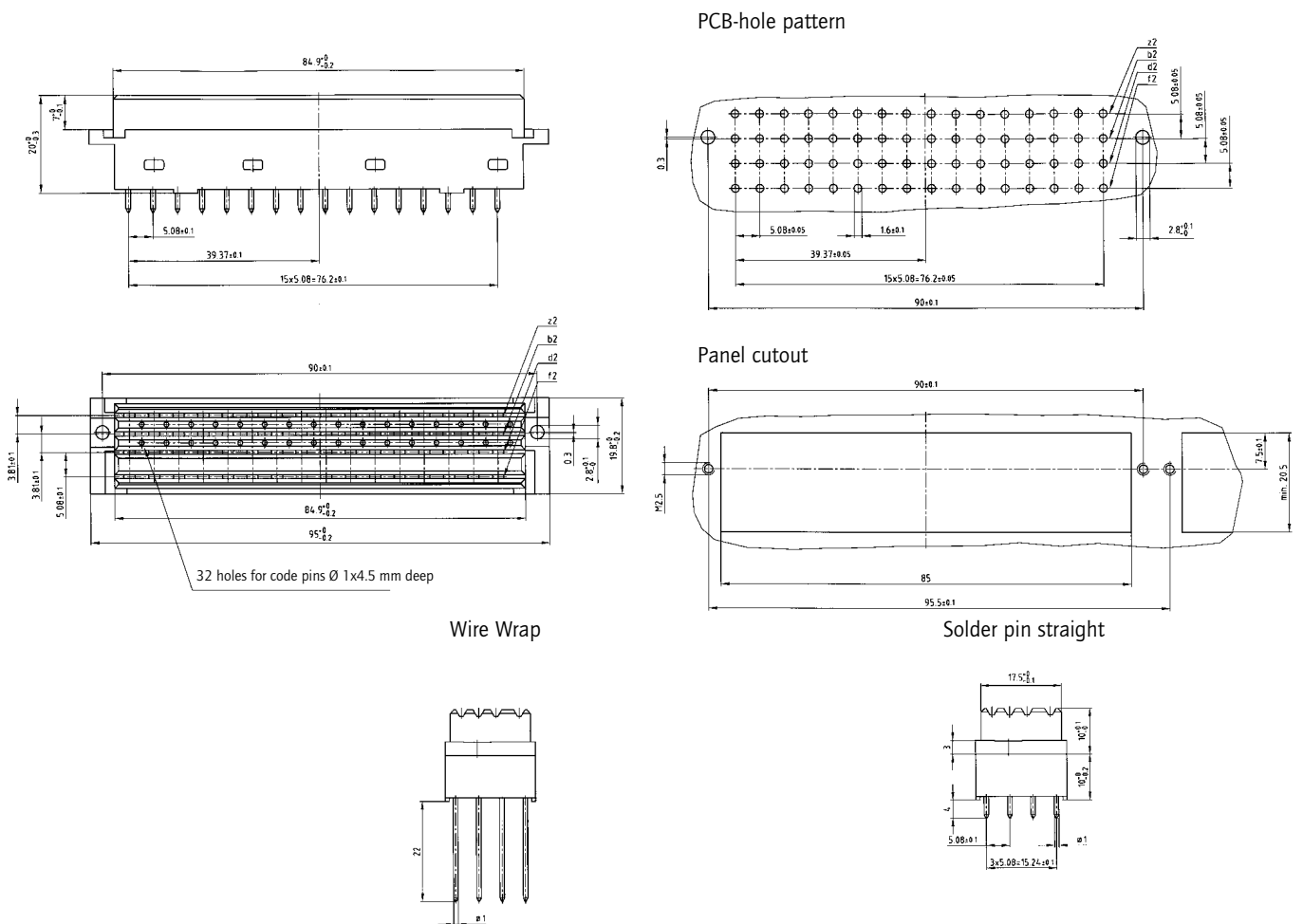

ORDER DATA

(Dim. = mm)

No. of Pos.	Row	Wire Wrap	Solder pin straight
64	z b d f	122 A 11129 X	122 A 11139 X

TYPE H

Male connector – angled – 15 positions

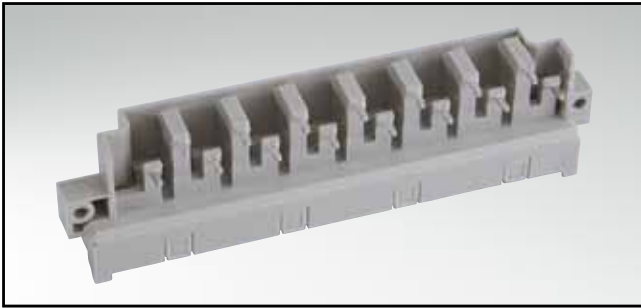

RoHS compliant

DESCRIPTION

- Solder pin
- With breakout area for coding
- Contact plating: silver
- Premating contacts in row "z" available

PRODUCT DRAWING

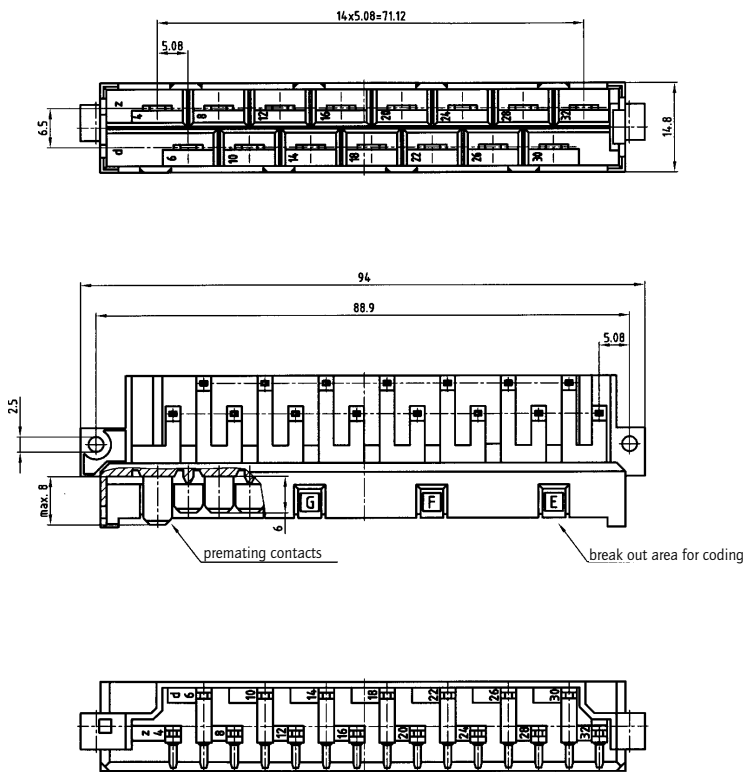

PCB-hole pattern

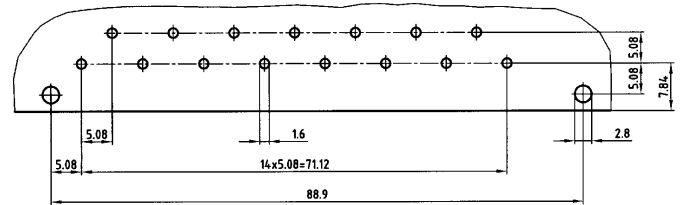

Solder pin angled

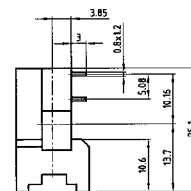

(Dim. = mm)

ORDER DATA

No. of Pos.	Premating contacts	Solder pin angled
15		121 E 21119 X
14 + 1	z 32	121 E 21109 X
13 + 2	z 4 + 32	121 E 21129 X

TYPE H

Female connector – straight and angled – 15 positions

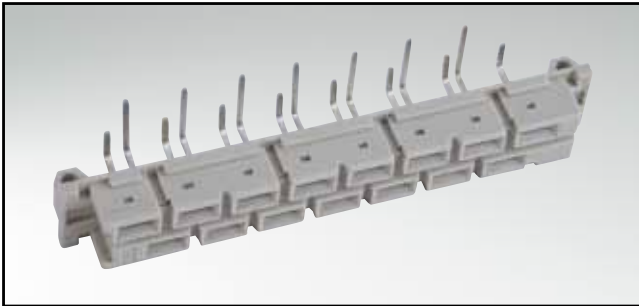

RoHS compliant

DESCRIPTION

- Solder pin, solder lug, Faston- and screw termination
- With breakout area for coding
- Contact plating: silver

PRODUCT DRAWING

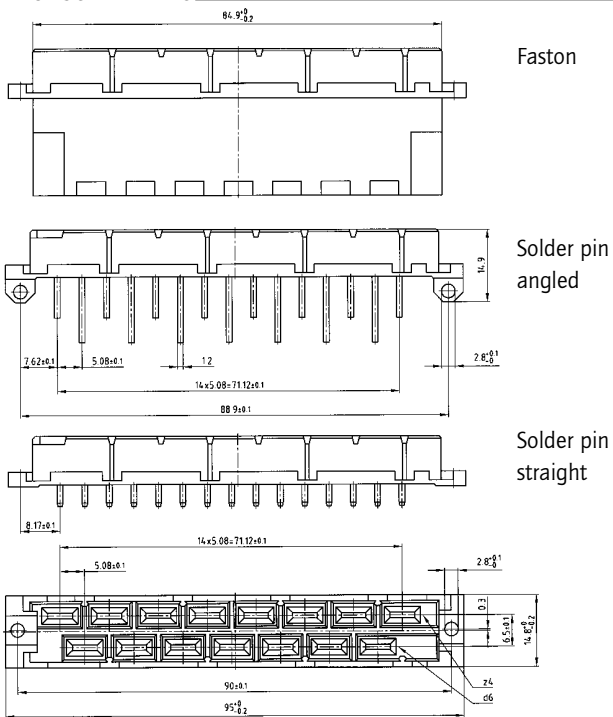

PCB-hole pattern

Solder pin angled 5.08 mm

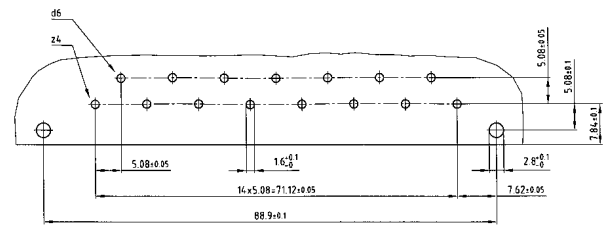

Solder pin straight 10.16 mm

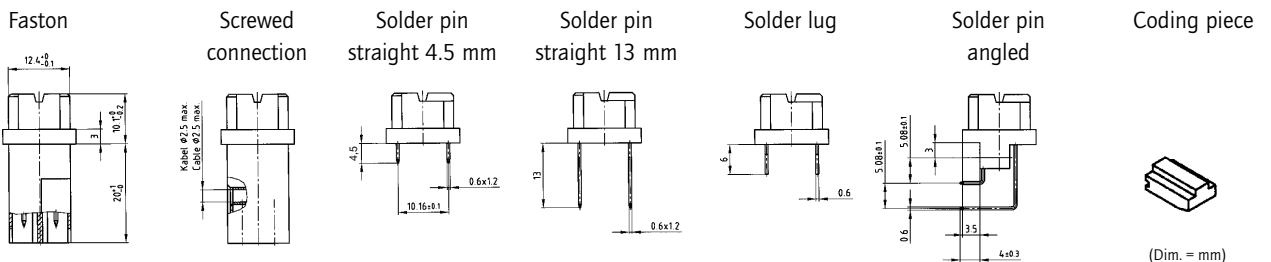
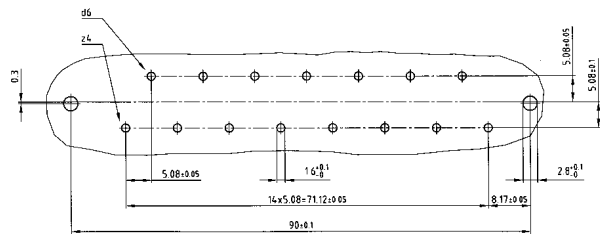

ORDER DATA

No. of Pos.	Faston	Screwed connection	Solder pin straight 4.5 mm	Solder pin straight 13 mm	Solder lug	Solder pin angled	Coding piece
15	122 E 11609 X	122 E 11619 X	122 E 11629 X	122 E 11639 X	122 E 11649 X	122 E 11659 X	120 X 10019 X

TYPE H

Male connector – angled – 11 positions

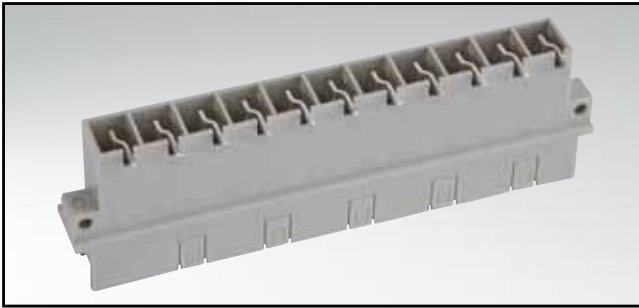

RoHS compliant

DESCRIPTION

- Solder pin
- With breakout area for coding
- Contact plating: silver
- Premating contacts in row "z" available

PRODUCT DRAWING

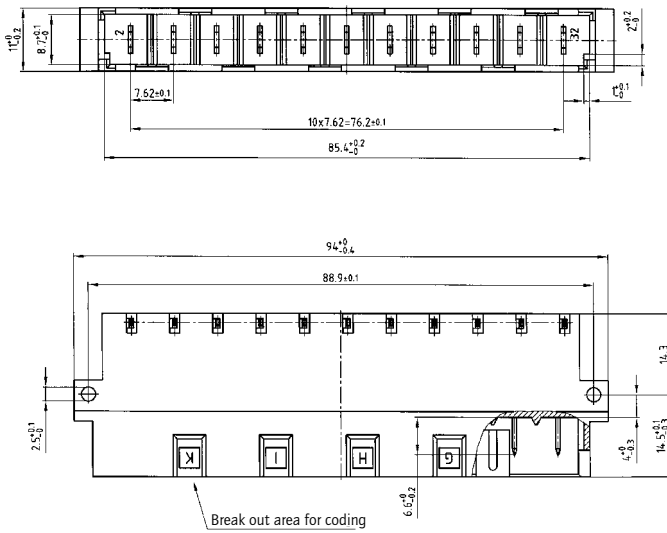

PCB-hole pattern

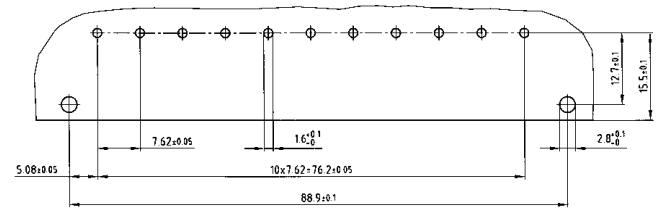

Solder pin angled

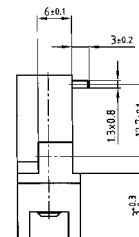

ORDER DATA

(Dim. = mm)

No. of Pos.	Premating contact	Solder pin angled
11		121 E 10949 X
10+1	z 32	121 E 10959 X

TYPE F+H (MIXED CONNECTOR)

Female connector – straight – 24+7 positions

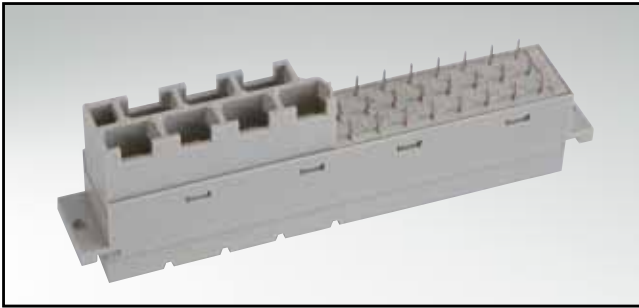

RoHS compliant

DESCRIPTION

- Solder pin und Faston
- Quality class 2

PRODUCT DRAWING

Panel cutout

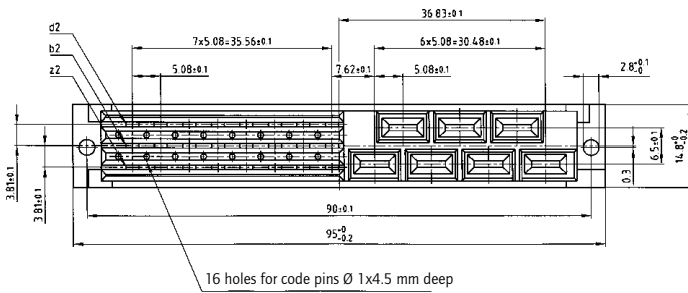
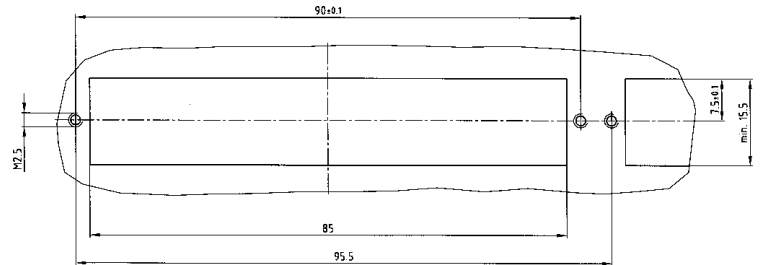
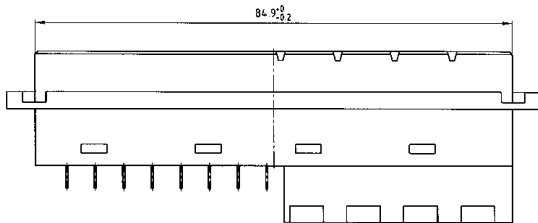

Solder pin / Faston

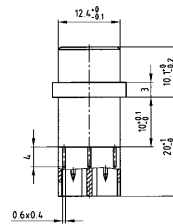

ORDER DATA

(Dim. = mm)

No. of Pos.	Solder pin / Faston
24+7	122 B 11159 X

TYPE C

Female connector – Insulation displacement termination (IDC) – 64 positions

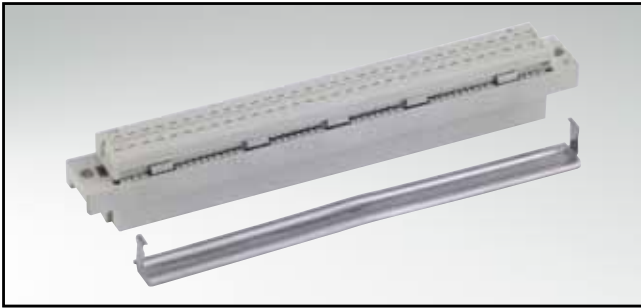

DESCRIPTION

- Ribbon cable termination
- Strain relief need to be ordered separately
- Quality class 3 (also available in quality class 2 or 1)

PRODUCT DRAWING

Female connector with strain relief

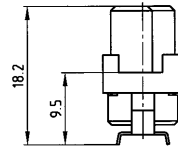
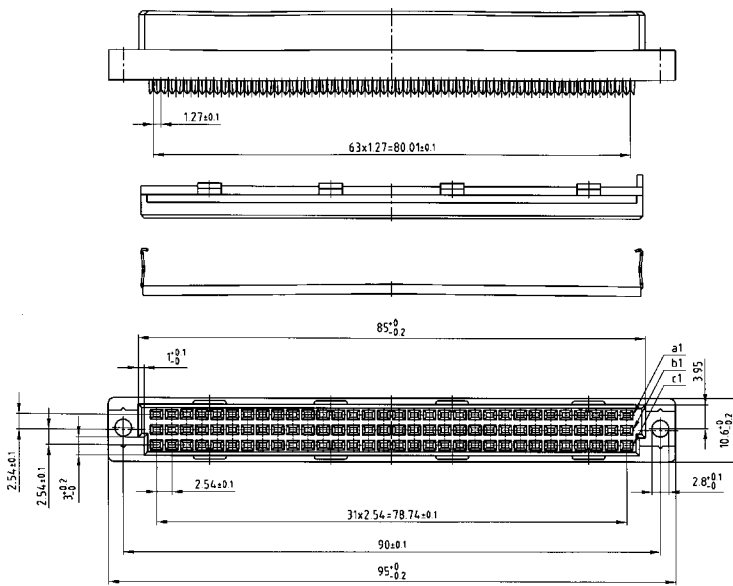

Female connector without strain relief

Strain relief

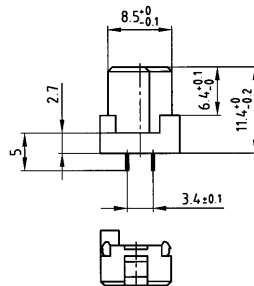

ORDER DATA

(Dim. = mm)

No. of Pos.	• = contact, + = no contact					Female connector without strain relief	Strain relief	
	Pos.	1	2	3	4			5
64	a	•	•	•	•	122 A 11699 X	120 X 10169 X	
	b	+	+	+	+			+
	c	•	•	•	•			•

INTERCONNECTION HOUSING

Housing and locking clips for type C and R



DESCRIPTION

- Usable for female connectors type C and R
- Locking-clips to secure and to unlock the female connector
- For PCB which a thickness from 3.2 to 3.6 mm and a pin length of 13 or 17 mm

PRODUCT DRAWING

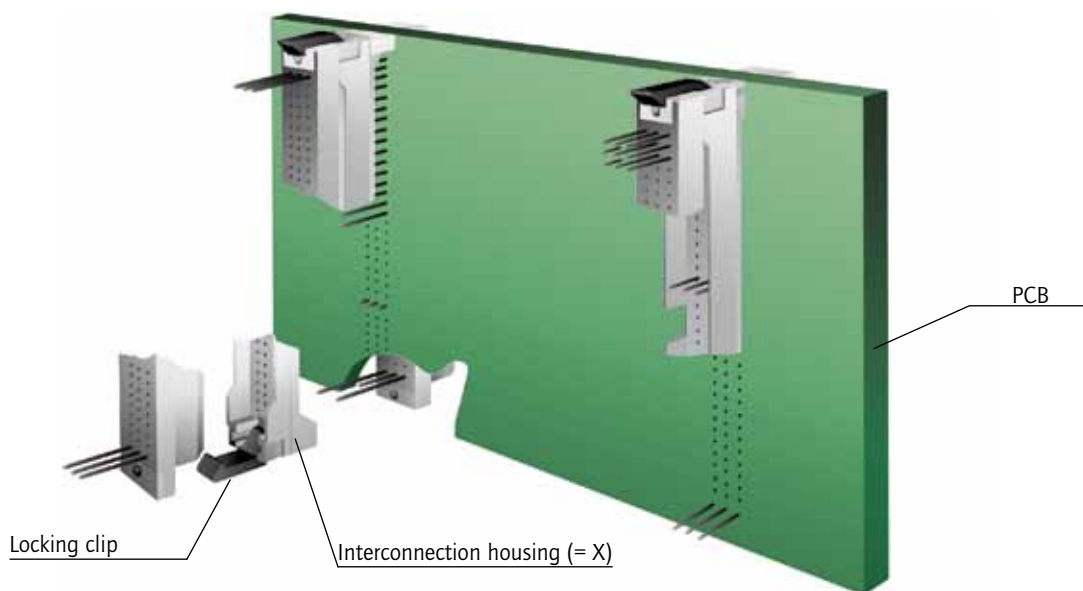

ORDER DATA

(Dim. = mm)

No. of Pos.	X (mm)	Interconnection housing	LOCKING CLIPS	
			Type C	Type R
96	4.6	120 X 10089 X	120 X 10129 X	120 X 10149 X
96	8.6	120 X 10099 X	120 X 10129 X	120 X 10149 X
96	9.3	120 X 10109 X	120 X 10129 X	120 X 10149 X
96	10.0	120 X 10119 X	120 X 10129 X	120 X 10149 X

PLUG-IN FRAME

Frame for printed circuit boards (PCB)



RoHS compliant

DESCRIPTION

- For DIN EN 60603-2 and DIN 41617 connectors
- For PCB width 100 mm and 102 mm
- Material: polycarbonat, grey
- Other colours on request
- Mounting set needs to be ordered separately

PRODUCT DRAWING

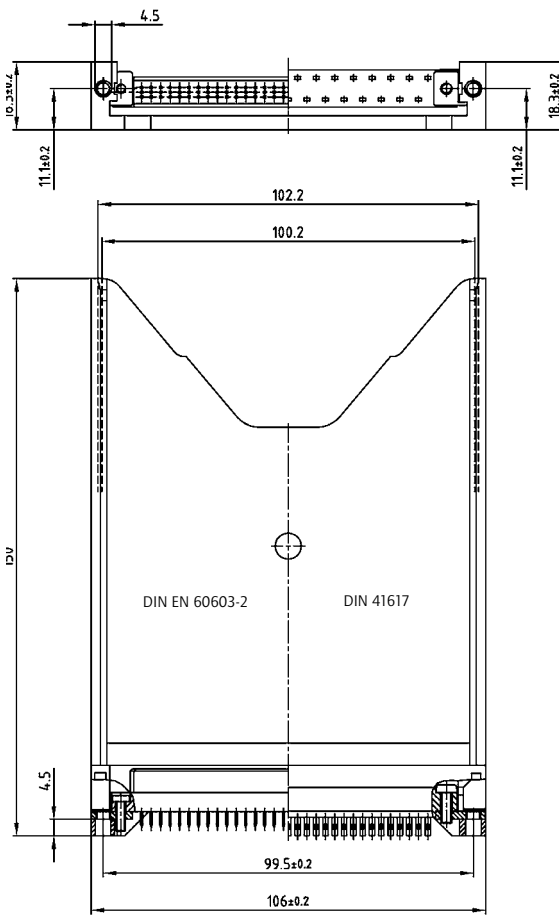

Mounting set for
DIN EN 60603-2

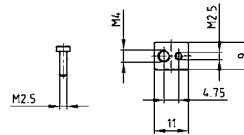

Mounting set for
DIN 41617

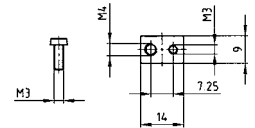

ORDER DATA

(Dim. = mm)

PLUG-IN FRAME		MOUNTING SET FOR	
grey – 100 mm	grey – 102 mm	DIN EN 60603-2	DIN 41617
120 X 10029 X	120 X 10039 X	120 X 10059 X	120 X 10049 X

CODING STRIPS

For connectors DIN EN 60603-2 (DIN 41612)

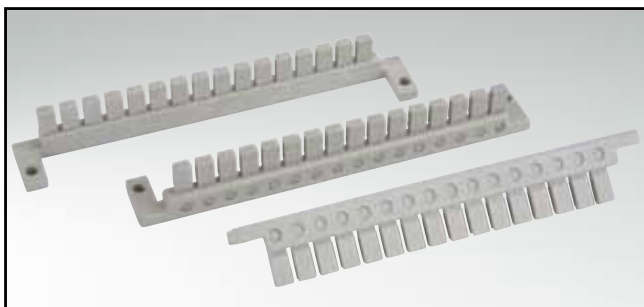

RoHS compliant

DESCRIPTION

- Mounting style:
 - inside the enclosure (mounting bar)
 - on printed circuit board (PCB)
- Optional coding by removing the segments

PRODUCT DRAWING

Type D, E, F

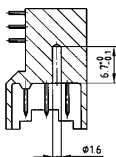

Type R, H

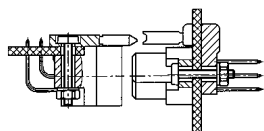

Type C, R, D

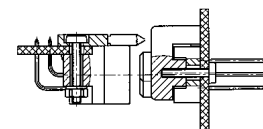

Coding pin

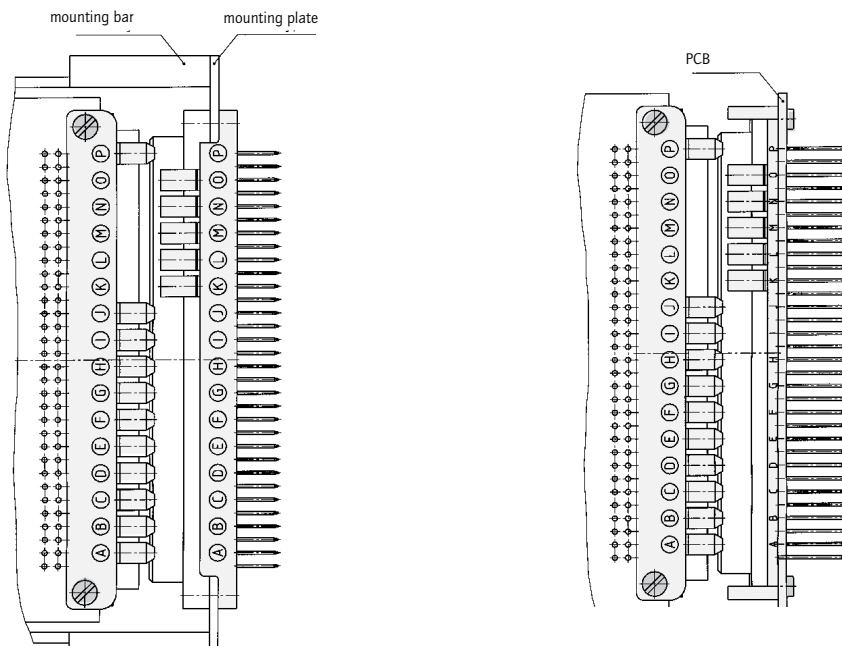
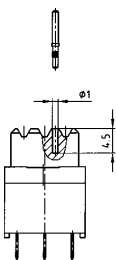

ORDER DATA

(Dim. = mm)

CODING PIN	Female connector (mounting plate)	CODING STRIPS FOR Male connector	Female connector (PCB)
120 X 10319 X	120 X 10379 X	120 X 10359 X	120 X 10369 X

SECTION 5

COMBINATION CONNECTORS DIN EN

The combination connectors in accordance with DIN EN 60603-2 offer a variety of applications. The design allows a combination of signal, high current, high voltage and coaxial contacts.

Standard termination types such as solder cup, PCB solder tails, straight right angle and wire wrap tails are available.



60603-2

**Product features:**

- Saves space on your PCB
- Various termination method
- Cost factor, one item as compared with separate connectors
- Easy assembly of high power and coaxial contacts
- High power and coaxial contacts are screw-machine types
- Gold plating options available

Fully assembled connectors with high power or coaxial contacts are available.



PART NUMBER CREATOR

9 0 7 8 M 2 M A T 1 1 X 9 0 X

Type

9 = Type M - DIN EN 60603-2

Variations

Type M = 40+4, 42+6, 52+2, 60+4, 78+2

Type M = 16+8, 24+8, 28+6

Mini type M = 8+4, 12+4, 20+2, 30+2

+ = to substitute "M" (look at example)

Type of contact

M = Male connector

F = Female connector

Quality class for contacts

A = Quality class 3 = 50 cycles

B = Quality class 2 = 400 cycles

C* = Quality class 1 = 500 cycles *on request

Termination only for signal contacts

N* = Wire Wrap *not available as male connector

R = solder pin straight

T* = solder pin angled *not available as female connector

Termination for high power and coaxial contacts

11/27 = Solder lug 10 A

12/28 = Solder lug 20 A

14/29 = Solder lug 40 A

19/39 = Solder pin straight 20 A

20/40 = Solder pin straight 40 A

18/17 = Solder pin angled 10 A

21/16 = Solder pin angled 20 A

23/15 = Solder pin angled 40 A

26/13 = 4 solder pins angled 40 A

31 = 5 solder pins straight 50 Ω

32 = 5 solder pins straight 50 Ω

33 = 5 solder pins straight 75 Ω

35 = 5 solder pins angled 50 Ω

36 = 5 solder pins angled 75 Ω

99 = without contacts

Mounting style

X9 = Mounting hole for screwed or rivet

Standard

OX = Standard

TECHNICAL INFORMATION

SKIN EFFECT

Alternating currents do not uniformly occupy the entire cross section of the conductor, rather inductance effect in the conductor deflects the current towards the surface of the conductor, whereby this deflection increases with the frequency. The resistive attenuation of a transmission line increases with the frequency as a result of this skin effect. The skin depth (equivalent thickness of the layer in which current flows) can be determined using

$$\delta = \frac{1}{\sqrt{f \pi \sigma \mu_0 \mu_r}}$$

f = frequency

σ = conductivity of the conductor material

$\sigma_{Ag} = 62 \times 10^6 \text{ S/m}$

$\sigma_{Cu} = 58 \times 10^6 \text{ S/m}$

$\mu_0 = 1,256 \times 10^{-6} \text{ Vs / Am}$

μ_r ... relative permeability constant for the employed material

VSWR-VALUE

The ration between the value of the largest and the smallest voltages on a loss-free line is known as the ripple or voltage standing wave ratio s (with $1 \leq s < \infty$). The reciprocal value of the VSWR is known as the inverse voltage standing wave ratio m (with $0 < m \leq 1$). (VSWR = Voltage standing wave ratio). The value of s is linked with the \rightarrow reflection coefficient r on s transmissionline according to the equation.

$$s = \frac{(1 + |r|)}{(1 - |r|)}$$

CURRENT RATING / DERATING CURVE

Measurement is according to DIN 41640 part 3 whereas all power contacts are connected in series.

For test procedure - product-no. 9024M8FCR14X90X has been equipped with 124C10069X and 9024M8MCR14X90X with 123C10069X.

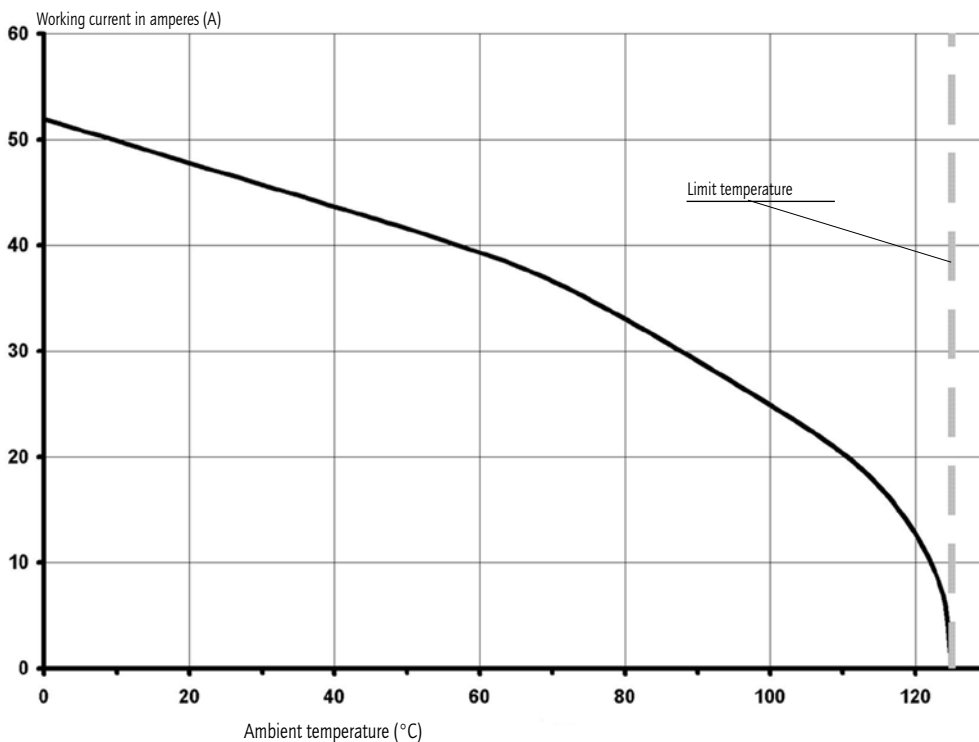

TECHNICAL DATA

Materials	Type M	Coaxial contacts	High power contacts	High voltage contacts
Insulator	PBT GF UL94V-0	PTFE/PBT/PI		PTFE
Contact plating	gold over nickel			
Contact material	copper alloy			
Retaining clip	copper alloy			
Current rating (DC)	2 A	2 A	10 to 40 A	2 A
Test voltage	1000 V, 50 Hz			
Resistance between mated contacts	≤ 2.7 mΩ			
Insulation resistance		10 ⁷ MΩ		≥2x10 ⁷ MΩ
Volume resistivity	10 ¹⁶ Ωcm			
Dielectric strength	50 KV/ mm			
Characteristic impedance		50/75 Ω		
Contact resistance	inner conductor outer conductor	≤ 2.7 mΩ ≤ 2.7 mΩ	≤ 2.7 mΩ ≤ 2.7 mΩ	≤ 1 mΩ ≤ 2.7 mΩ
VSWR-value according to MIL-C-39012	1.2 GHz 1.5 GHz 2.0 GHz	≤ 1.2 ≤ 1.3 ≤ 1.5		
Dielectric voltage		750 V 50 Hz		3.8 kV
Frequency range		0 to 2 GHz		
Working voltage	250 V	250 V		max. 2.8 kV
Temperature range	-55 °C to +125 °C	-55 °C to +135 °C	-55 °C to +155 °C	-55 °C to +125 °C
Mating force per signal contact	≤ 3.4 N	≤ 7 N	≤ 7 N	≤ 5 N
Withdrawal force per signal contact	≥ 0.2 N	≤ 7 N	ca. 5 N	ca. 2.5 N
Mating cycles	depending on plating			

Technical alterations are subjects to change without notice.

CRIMPING INSTRUCTIONS FOR COAXIAL CONTACTS

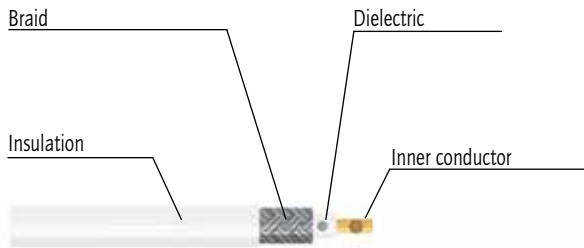

Strip the wire



Slide sleeve over coax cable



Crimp the inner contact on the inner conductor



Snap the inner contact into the outer contact



Slide braid over outer contact



Crimp the sleeve on to outer contact

TYPE M

Male connector – straight and angled

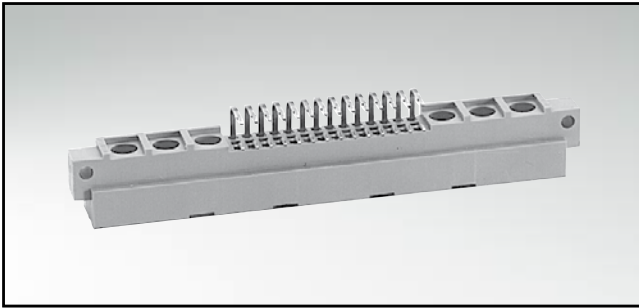

RoHS compliant

DESCRIPTION

- Solder pin
- No. of Pos. 16+8 - 24+8 - 28+6 - 40+4 - 42+6 - 52+2 - 60+4 - 78+2
- Quality class 3 (also available in quality class 2 or 1)
- Part number creator on page 5 | 2
- For assembly with PCB power and coaxial contacts please contact factory

PRODUCT DRAWING

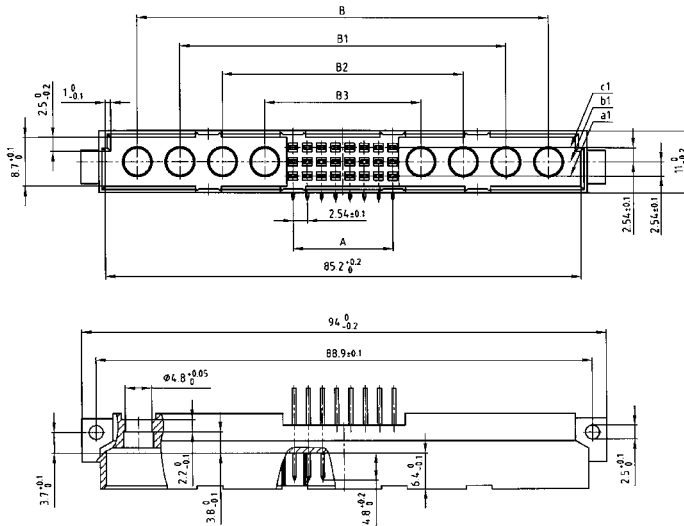

No. of Pos.	A ±0.1	B ±0.1	B1 ±0.1	B2 ±0.1	B3 ±0.1
78 + 2	25x2.54=63.50	29x2.54=73.66	-	-	-
52 + 2	25x2.54=63.50	29x2.54=73.66	-	-	-
60 + 4	19x2.54=48.26	29x2.54=73.66	23x2.54=58.42	-	-
40 + 4	19x2.54=48.26	29x2.54=73.66	23x2.54=58.42	-	-
42 + 6	13x2.54=33.02	29x2.54=73.66	23x2.54=58.42	17x2.54=43.18	-
28 + 6	13x2.54=33.02	29x2.54=73.66	23x2.54=58.42	17x2.54=43.18	-
24 + 8	7x2.54=17.78	29x2.54=73.66	23x2.54=58.42	17x2.54=43.18	11x2.54=27.94
16 + 8	7x2.54=17.78	29x2.54=73.66	23x2.54=58.42	17x2.54=43.18	11x2.54=27.94

Solder pin angled **T**

Solder pin straight **R**

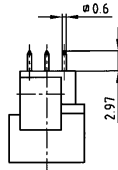
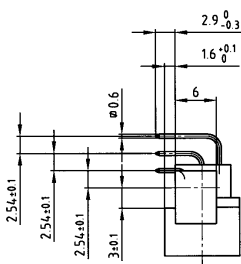

 = Ordering code

ORDER DATA

(Dim. = mm)

No. of Pos.	Version																																
	1	2	3	4	5	6	7	8	9	10	11	12	13	14	15	16	17	18	19	20	21	22	23	24	25	26	27	28	29	30	31	32	
78 + 2	a	+	•	•	•	•	•	•	•	•	•	•	•	•	•	•	•	•	•	•	•	•	•	•	•	•	•	•	•	•	•	•	+
	b	•	•	•	•	•	•	•	•	•	•	•	•	•	•	•	•	•	•	•	•	•	•	•	•	•	•	•	•	•	•	•	•
	c	•	•	•	•	•	•	•	•	•	•	•	•	•	•	•	•	•	•	•	•	•	•	•	•	•	•	•	•	•	•	•	•
52 + 2	a	+	+	+	+	+	+	+	+	+	+	+	+	+	+	+	+	+	+	+	+	+	+	+	+	+	+	+	+	+	+	+	
	b	•	•	•	•	•	•	•	•	•	•	•	•	•	•	•	•	•	•	•	•	•	•	•	•	•	•	•	•	•	•	•	
	c	•	•	•	•	•	•	•	•	•	•	•	•	•	•	•	•	•	•	•	•	•	•	•	•	•	•	•	•	•	•	•	
60 + 4	a	+	+	•	•	•	•	•	•	•	•	•	•	•	•	•	•	•	•	•	•	•	•	•	•	•	•	•	•	•	•	+	
	b	•	•	•	•	•	•	•	•	•	•	•	•	•	•	•	•	•	•	•	•	•	•	•	•	•	•	•	•	•	•	•	
	c	•	•	•	•	•	•	•	•	•	•	•	•	•	•	•	•	•	•	•	•	•	•	•	•	•	•	•	•	•	•	•	
40 + 4	a	+	+	+	+	+	+	+	+	+	+	+	+	+	+	+	+	+	+	+	+	+	+	+	+	+	+	+	+	+	+	+	
	b	•	•	•	•	•	•	•	•	•	•	•	•	•	•	•	•	•	•	•	•	•	•	•	•	•	•	•	•	•	•	•	
	c	•	•	•	•	•	•	•	•	•	•	•	•	•	•	•	•	•	•	•	•	•	•	•	•	•	•	•	•	•	•	•	

No. of Pos.	Version																															
	1	2	3	4	5	6	7	8	9	10	11	12	13	14	15	16	17	18	19	20	21	22	23	24	25	26	27	28	29	30	31	32
42 + 6	a	+	+	+	•	•	•	•	•	•	•	•	•	•	•	•	•	•	•	•	•	•	•	•	•	•	•	•	•	•	•	•
	b	•	•	•	•	•	•	•	•	•	•	•	•	•	•	•	•	•	•	•	•	•	•	•	•	•	•	•	•	•	•	•
	c	•	•	•	•	•	•	•	•	•	•	•	•	•	•	•	•	•	•	•	•	•	•	•	•	•	•	•	•	•	•	•
28 + 6	a	+	+	+	+	+	+	+	+	+	+	+	+	+	+	+	+	+	+	+	+	+	+	+	+	+	+	+	+	+	+	
	b	•	•	•	•	•	•	•	•	•	•	•	•	•	•	•	•	•	•	•	•	•	•	•	•	•	•	•	•	•	•	•
	c	•	•	•	•	•	•	•	•	•	•	•	•	•	•	•	•	•	•	•	•	•	•	•	•	•	•	•	•	•	•	•
24 + 8	a	+	+	+	+	•	•	•	•	•	•	•	•	•	•	•	•	•	•	•	•	•	•	•	•	•	•	•	•	•	•	+
	b	•	•	•	•	•	•	•	•	•	•	•	•	•	•	•	•	•	•	•	•	•	•	•	•	•	•	•	•	•	•	•
	c	•	•	•	•	•	•	•	•	•	•	•	•	•	•	•	•	•	•	•	•	•	•	•	•	•	•	•	•	•	•	•
16 + 8	a	+	+	+	+	+	+	+	+	+	+	+	+	+	+	+	+	+	+	+	+	+	+	+	+	+	+	+	+	+	+	
	b	•	•	•	•	•	•	•	•	•	•	•	•	•	•	•	•	•	•	•	•	•	•	•	•	•	•	•	•	•	•	•
	c	•	•	•	•	•	•	•	•	•	•	•	•	•	•	•	•	•	•	•	•	•	•	•	•	•	•	•	•	•	•	•

TYPE M/2

Male connector – straight and angled

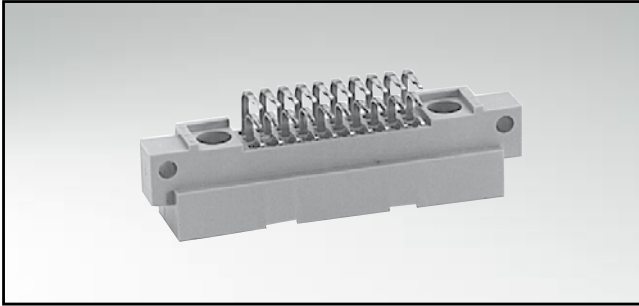

RoHS compliant

DESCRIPTION

- Solder pin
- No. of Pos. 8+4 - 12+4 - 20+2 - 30+2
- Quality class 3 (also available in quality class 2 or 1)
- Part number creator on page 5 | 2
- For assembly with PCB power and coaxial contacts please contact factory

PRODUCT DRAWING

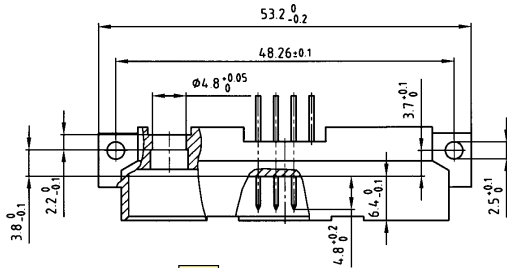
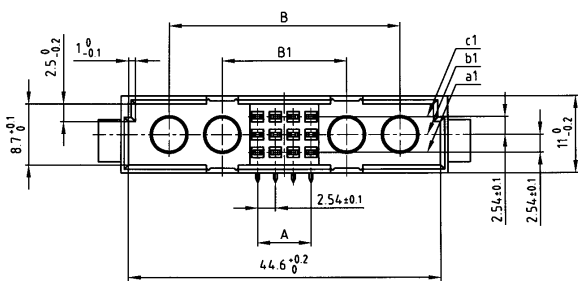

Solder pin angled **T**

Solder pin straight **R**

No. of Pos.	A ±0.1	B ±0.1	B ₁ ±0.1
30 + 2	9x2.54=22.86	13x2.54=33.02	-
20 + 2	9x2.54=22.86	13x2.54=33.02	-
12 + 4	3x2.54=7.62	13x2.54=33.02	7x2.54=17.78
8 + 4	3x2.54=7.62	13x2.54=33.02	7x2.54=17.78

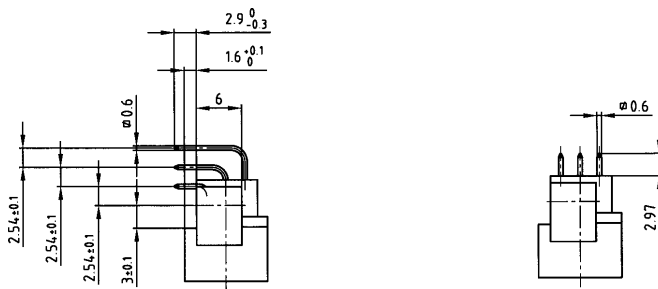

= Ordering code

ORDER DATA

(Dim. = mm)

No. of Pos.	Version • = contact, + = no contact															
	1	2	3	4	5	6	7	8	9	10	11	12	13	14	15	16
30+2	a	+	•	•	•	•	•	•	•	•	•	•	•	•	•	+
	b	•	•	•	•	•	•	•	•	•	•	•	•	•	•	•
	c	•	•	•	•	•	•	•	•	•	•	•	•	•	•	•
20+2	a	+	+	+	+	+	+	+	+	+	+	+	+	+	+	+
	b	•	•	•	•	•	•	•	•	•	•	•	•	•	•	•
	c	•	•	•	•	•	•	•	•	•	•	•	•	•	•	•

No. of Pos.	Version • = contact, + = no contact															
	1	2	3	4	5	6	7	8	9	10	11	12	13	14	15	16
12+4	a	+	+	•	•	•	•	•	•	•	•	•	•	•	•	•
	b	•	•	•	•	•	•	•	•	•	•	•	•	•	•	•
	c	•	•	•	•	•	•	•	•	•	•	•	•	•	•	•
8+4	a	+	+	+	+	•	•	•	•	•	•	•	•	•	•	•
	b	•	•	•	•	•	•	•	•	•	•	•	•	•	•	•
	c	•	•	•	•	•	•	•	•	•	•	•	•	•	•	•

TYPE M/2

Female connector – straight

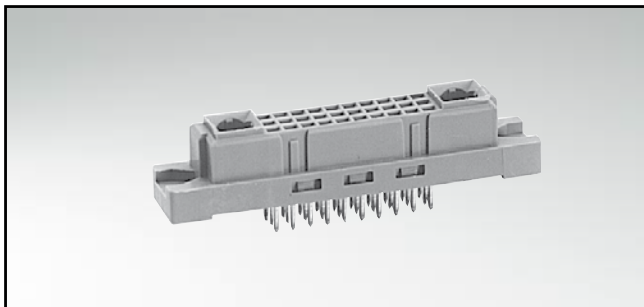

RoHS compliant

DESCRIPTION

- Solder pin and Wire Wrap
- No. of Pos. 8+4 - 12+4 - 20+2 - 30+2
- Quality class 3 (also available in quality class 2 or 1)
- Part number creator on page 5 | 2
- For assembly with PCB power and coaxial contacts please contact factory

PRODUCT DRAWING

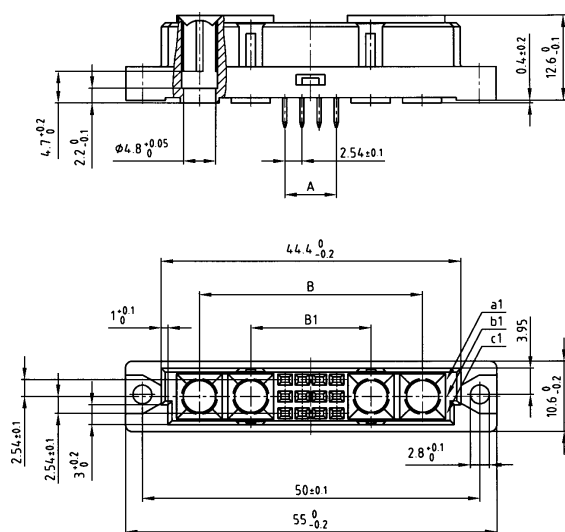

No. of Pos.	A ^{+0.1}	B ^{+0.1}	B ₁ ^{+0.1}
30 + 2	9x2.54=22.86	13x2.54=33.02	-
20 + 2	9x2.54=22.86	13x2.54=33.02	-
12 + 4	3x2.54=7.62	13x2.54=33.02	7x2.54=17.78
8 + 4	3x2.54=7.62	13x2.54=33.02	7x2.54=17.78

Solder pin straight 4 mm **R**

Wire Wrap **N**

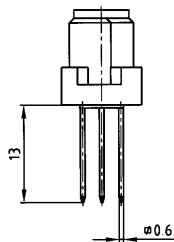
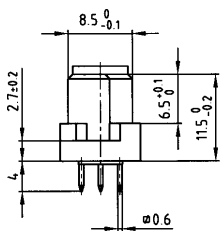

= Ordering code

ORDER DATA

(Dim. = mm)

No. of Pos.	Version															
	* = contact, + = no contact															
	1	2	3	4	5	6	7	8	9	10	11	12	13	14	15	16
30+2	a	+	•	•	•	•	•	•	•	•	•	•	•	•	•	+
	b	•	•	•	•	•	•	•	•	•	•	•	•	•	•	•
	c	•	•	•	•	•	•	•	•	•	•	•	•	•	•	•
20+2	a	+	+	+	+	+	+	+	+	+	+	+	+	+	+	+
	b	•	•	•	•	•	•	•	•	•	•	•	•	•	•	•
	c	•	•	•	•	•	•	•	•	•	•	•	•	•	•	•

No. of Pos.	Version															
	* = contact, + = no contact															
	1	2	3	4	5	6	7	8	9	10	11	12	13	14	15	16
12+4	a	+	+	•	•	•	•	•	•	•	•	•	•	•	•	•
	b	•	•	•	•	•	•	•	•	•	•	•	•	•	•	•
	c	•	•	•	•	•	•	•	•	•	•	•	•	•	•	•
8+4	a	+	+	+	+	+	+	+	+	+	+	+	+	+	+	+
	b	•	•	•	•	•	•	•	•	•	•	•	•	•	•	•
	c	•	•	•	•	•	•	•	•	•	•	•	•	•	•	•

TYPE M

High power contacts – solder cup – straight

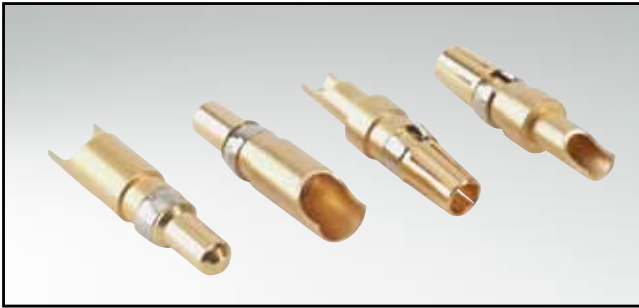

RoHS compliant

DESCRIPTION

- Precision machined contacts
- Quality class 3: gold flash
- Quality class 1: 0.8µm gold on mating side
- Other quality classes on request
- Assembled contacts available on request

PRODUCT DRAWING

Socket contact

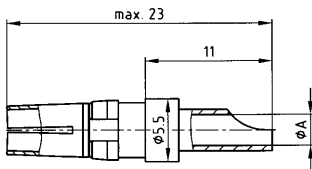

Plug contact

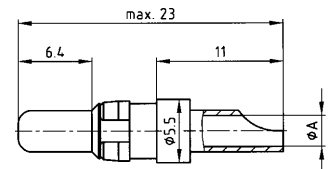

AWG	Current Rating	ØA ^{+0.15}
16 - 20	10 A	1,80
12 - 14	20 A	2,70
8 - 10	30 A	4,80

Premating contact

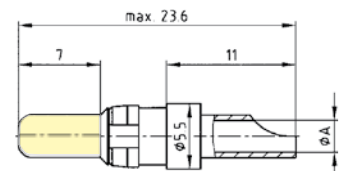

ORDER DATA

(Dim. = mm)

SOCKET CONTACT				
AWG	Current rating	Quality class	Termination	Part number
16 - 20	10 A	1	11	124 C 10039 X
16 - 20	10 A	3	27	124 A 10039 X
12 - 14	20 A	1	12	124 C 10049 X
12 - 14	20 A	3	28	124 A 10049 X
8 - 10	40 A	1	14	124 C 10069 X
8 - 10	40 A	3	29	124 A 10069 X

PLUG CONTACT				
AWG	Current rating	Quality class	Termination	Part number
16 - 20	10 A	1	11	123 C 10039 X
16 - 20	10 A	3	27	123 A 10039 X
12 - 14	20 A	1	12	123 C 10049 X
12 - 14	20 A	3	28	123 A 10049 X
8 - 10	40 A	1	14	123 C 10069 X
8 - 10	40 A	3	29	123 A 10069 X

PREMATING CONTACT			
AWG	Current rating	Quality class	Part number
16 - 20	10 A	1	123 C 10139 X
12 - 14	20 A	1	123 C 10149 X
8 - 10	40 A	1	123 C 10169 X

TYPE M

High power contacts – crimp – straight



RoHS compliant

DESCRIPTION

- Precision machined contacts
- Quality class 3: gold flash
- Quality class 1: 0.8µm gold on mating side
- Other quality classes on request

PRODUCT DRAWING

Socket contact

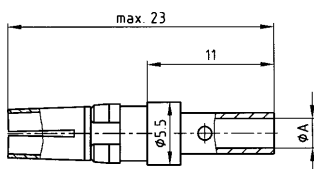

Plug contact

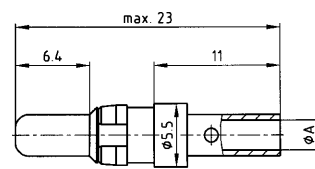

AWG	Current Rating	$\phi A^{+0.15}$	$\phi B_{max.}$
16 - 20	10 A	1,70	1,70
12 - 14	20 A	2,60	2,60
10 - 12	30 A	3,70	3,70
8 - 10	40 A	4,60	4,60

Wire stripping

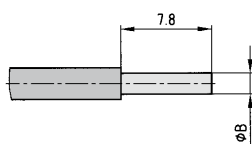

Premating contact

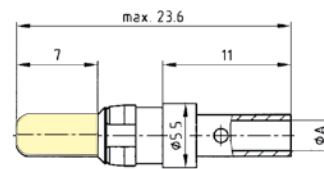

ORDER DATA

(Dim. = mm)

SOCKET CONTACT				PLUG CONTACT				PREMATING CONTACT			
AWG	Current rating	Quality class	Part number	AWG	Current rating	Quality class	Part number	AWG	Current rating	Quality class	Part number
16 - 20	10 A	1	124 C 11019 X	16 - 20	10 A	1	123 C 11019 X	16 - 20	10 A	1	123 C 11119 X
16 - 20	10 A	3	124 A 11019 X	16 - 20	10 A	3	123 A 11019 X	12 - 14	20 A	1	123 C 11129 X
12 - 14	20 A	1	124 C 11029 X	12 - 14	20 A	1	123 C 11029 X	10 - 12	30 A	1	123 C 11139 X
12 - 14	20 A	3	124 A 11029 X	12 - 14	20 A	3	123 A 11029 X	8 - 10	40 A	1	123 C 11149 X
10 - 12	30 A	1	124 C 11039 X	10 - 12	30 A	1	123 C 11039 X				
10 - 12	30 A	3	124 A 11039 X	10 - 12	30 A	3	123 A 11039 X				
8 - 10	40 A	1	124 C 11049 X	8 - 10	40 A	1	123 C 11049 X				
8 - 10	40 A	3	124 A 11049 X	8 - 10	40 A	3	123 A 11049 X				

TYPE M

High power contacts – solder pin – straight

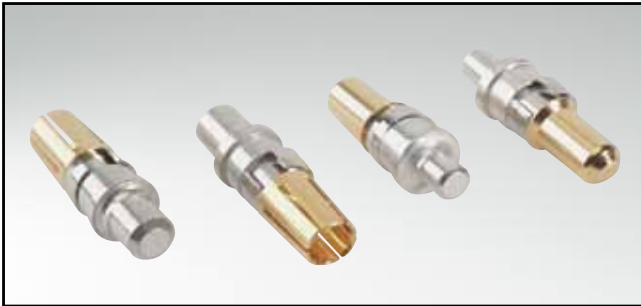

RoHS compliant

DESCRIPTION

- Precision machined contacts
- Quality class 3: gold flash
- Quality class 1: 0.8µm gold on mating side
- Other quality classes on request
- Assembled contacts available on request

PRODUCT DRAWING

Socket contact

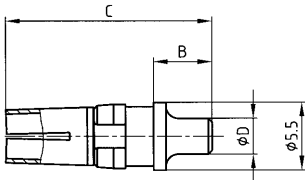

Plug contact

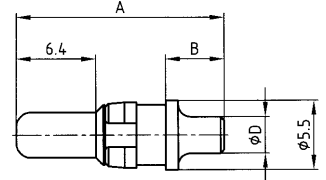

Current rating	A	A ₁	B	C	ØD
20 A	16.70	17.30	4.70	16.10	2.90
40 A	17.75	18.35	5.75	17.15	3.80

Premating contact

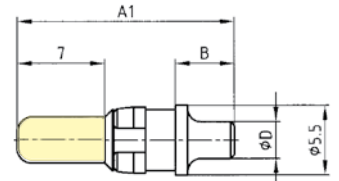

ORDER DATA

(Dim. = mm)

SOCKET CONTACT			
Current rating	Quality class	Termination	Part number
20 A	1	19	124 C 14029 X
20 A	3	39	124 A 14029 X
40 A	1	20	124 C 14049 X
40 A	3	40	124 A 14049 X

PLUG CONTACT			
Current rating	Quality class	Termination	Part number
20 A	1	19	123 C 14029 X
20 A	3	39	123 A 14029 X
40 A	1	20	123 C 14049 X
40 A	3	40	123 A 14049 X

PREMATING CONTACT			
Current rating	Quality class	Termination	Part number
20 A	1	19	123 C 14129 X
40 A	1	20	123 C 14149 X

TYPE M

High power contacts – solder pin – angled

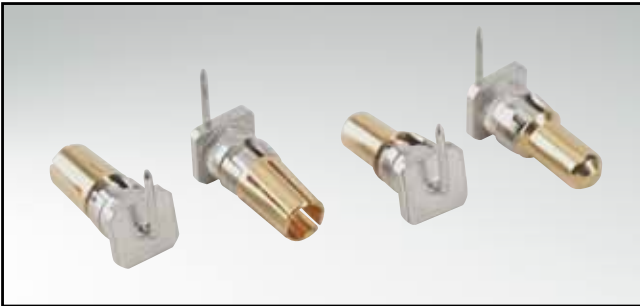

RoHS compliant

DESCRIPTION

- Precision machined contacts
- Quality class 3: gold flash
- Quality class 1: 0.8µm gold on mating side
- Other quality classes on request
- Assembled contacts available on request

PRODUCT DRAWING

Socket contact

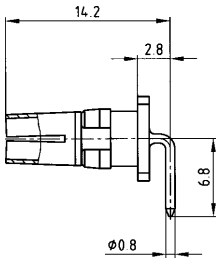

Plug contact

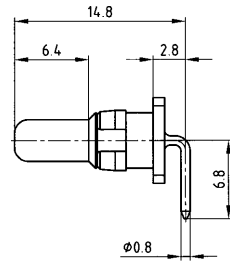

Premating contact

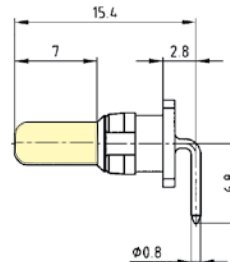

ORDER DATA

(Dim. = mm)

SOCKET CONTACT			
Current rating	Quality class	Termination	Part number
10 A	1	18	124 C 12019 X
10 A	3	17	124 A 12019 X

PLUG CONTACT			
Current rating	Quality class	Termination	Part number
10 A	1	18	123 C 12019 X
10 A	3	17	123 A 12019 X

PREMATING CONTACT		
Current rating	Quality class	Part number
10 A	1	123 C 12119 X

TYPE M

High power contacts – solder pin – angled



RoHS compliant

DESCRIPTION

- Precision machined contacts
- Quality class 3: gold flash
- Quality class 1: 0.8µm gold on mating side
- Other quality classes on request
- Assembled contacts available on request

PRODUCT DRAWING

Socket contact

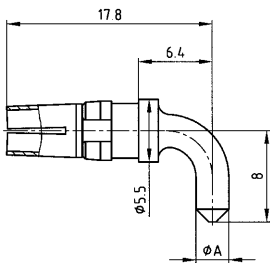

Plug contact

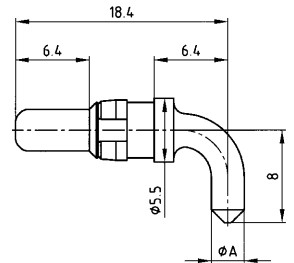

Current Rating	ØA
20 A	2.90
40 A	3.80

Premating contact

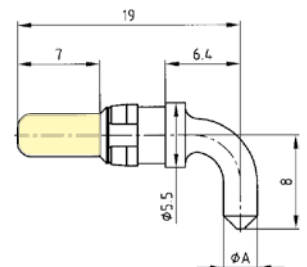

ORDER DATA

(Dim. = mm)

SOCKET CONTACT			
Current rating	Quality class	Termination	Part number
20 A	1	21	124 C 13019 X
20 A	3	16	124 A 13019 X
40 A	1	23	124 C 13039 X
40 A	3	15	124 A 13039 X

PLUG CONTACT			
Current rating	Quality class	Termination	Part number
20 A	1	21	123 C 13019 X
20 A	3	16	123 A 13019 X
40 A	1	23	123 C 13039 X
40 A	3	15	123 A 13039 X

PREMATING CONTACT		
Current rating	Quality class	Part number
20 A	1	123 C 13119 X
40 A	1	123 C 13139 X

TYPE M

High power contacts – solder pin – angled

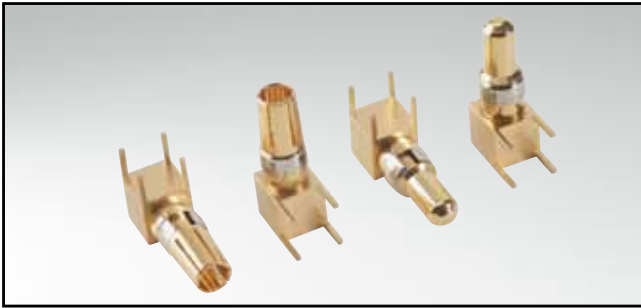

RoHS compliant

DESCRIPTION

- Precision machined contacts
- Quality class 3: gold flash
- Quality class 1: 0.8µm gold on mating side
- Other quality classes on request
- Assembled contacts available on request

PRODUCT DRAWING

Socket contact

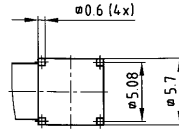
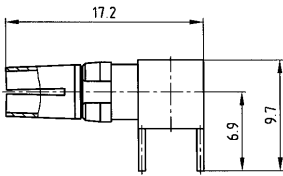

Plug contact

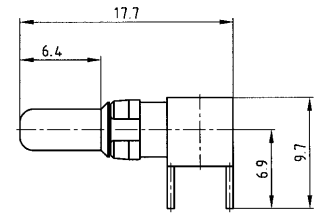

Premating contact

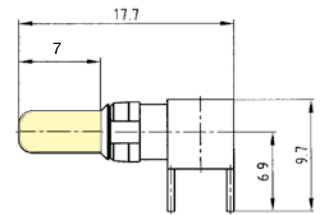

ORDER DATA

(Dim. = mm)

SOCKET CONTACT			
Current rating	Quality class	Termination	Part number
40 A	1	26	124 C 10019 X
40 A	3	13	124 A 10019 X

PLUG CONTACT			
Current rating	Quality class	Termination	Part number
40 A	1	26	123 C 10019 X
40 A	3	13	123 A 10019 X

PREMATING CONTACT		
Current rating	Quality class	Part number
40 A	1	123 C 10029 X

TYPE M

Coaxial contacts – straight – inner conductor solder – outer conductor crimp/solder termination

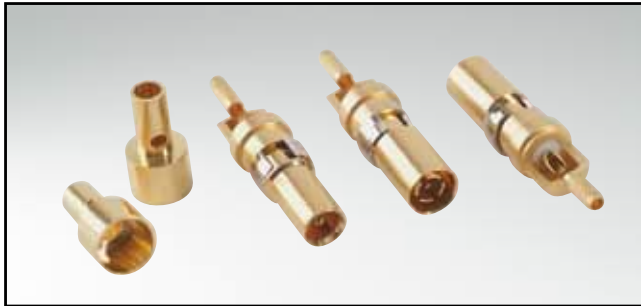

RoHS compliant

DESCRIPTION

- 50 and 75 Ω Version
- Socket contact suitable for male connectors
- Plug contact suitable for female connectors
- Contact platings:
 - 0.8µm gold mating side inner conductor
 - other platings on request
- Delivery includes: contacts and sleeve supplied loose

PRODUCT DRAWING

50 Ω Version

Socket contact

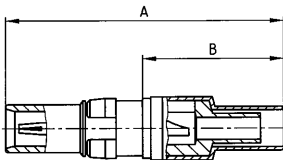

Plug contact

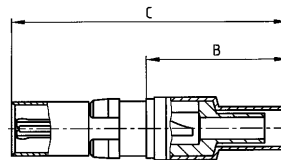

Wire stripping

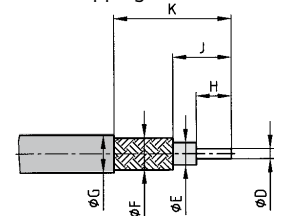

usable cable RG	A	B	C	ØD max.	ØE max.	ØF max.	ØG max.	H	J	K
178 B/U, 196 A/U, 404 U ⁺	24.2	12.3	23.9	0.90	1.2	1.4	2.3	2.5	5.0	10.0
174 U, 188 A/U, 316 U	24.2	12.3	23.9	0.80	1.9	2.3	3.2	2.5	5.0	10.0
316 U*	24.2	12.3	23.9	0.90	1.9	2.7	3.5	2.5	5.0	10.0
58 C/U, 141 A/U	25.4	13.5	25.2	0.90	3.0	4.1	5.2	3.0	5.0	9.5

* = double braided - ⁺ = low noise

75 Ω Version

Socket contact

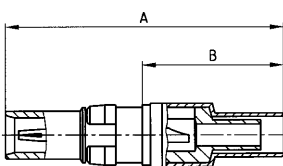

Plug contact

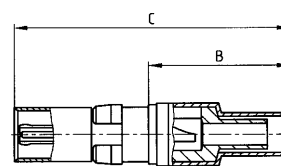

Wire stripping

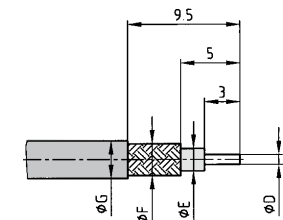

usable cable RG	A	B	C	ØD max.	ØE max.	ØF max.	ØG max.
179 B/U, 187 A/U	24.2	12.3	23.9	0.50	1.9	2.3	3.2
180 B/U	23.1	11.2	22.8	0.90	2.8	3.1	4.5

ORDER DATA

(Dim. = mm)

SOCKET CONTACT			PLUG CONTACT		
Version	Usable cable RG	Part number	Version	Usable cable RG	Part number
50 Ω	178 B/U, 196 A/U, 404 U ⁺	124 C 20059 X	50 Ω	178 B/U, 196 A/U, 404 U ⁺	123 C 20059 X
50 Ω	174 U, 188 A/U, 316 U	124 C 20069 X	50 Ω	174 U, 188 A/U, 316 U	123 C 20069 X
50 Ω	316 U *	124 C 20079 X	50 Ω	316 U *	123 C 20079 X
50 Ω	58 C/U, 141 A/U	124 C 20089 X	50 Ω	58 C/U, 141 A/U	123 C 20089 X
75 Ω	179 B/U, 187 A/U	124 C 30039 X	75 Ω	179 B/U, 187 A/U	123 C 30039 X
75 Ω	180 B/U	124 C 30049 X	75 Ω	180 B/U	123 C 30049 X

TYPE M

Coaxial contacts – straight – inner and outer conductor crimp termination



RoHS compliant

DESCRIPTION

- 50 Ω Version
- Socket contact suitable for male connectors
- Plug contact suitable for female connectors
- Contact platings:
 - 0.8µm gold mating side inner conductor
 - other platings on request
- Delivery includes: contacts and sleeve supplied loose

PRODUCT DRAWING

50 Ω Version

Socket contact

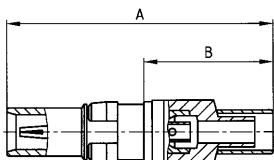

Plug contact

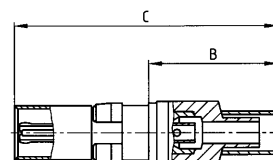

Wire stripping

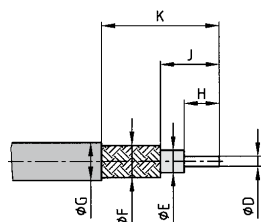

usable cable RG	A	B	C	ØD max.	ØE max.	ØF max.	ØG max.	H	J	K
174 U, 188 A/U, 316 U	23.1	11.2	22.9	0.60	1.9	2.3	3.2	3.0	4.3	9.3
58 C/U, 141 A/U	22.8	10.9	22.6	1.30	3.7	4.4	5.2	3.8	5.3	9.0
316 U*	23.1	11.2	22.9	0.60	1.9	3.0	3.8	3.0	4.3	9.3

* = double braided

(Dim. = mm)

ORDER DATA

SOCKET CONTACT			PLUG CONTACT		
Version	Usable cable RG	Part number	Version	Usable cable RG	Part number
50 Ω	174 U, 188 A/U, 316 U	124 C 21049 X	50 Ω	174 U, 188 A/U, 316 U	123 C 21049 X
50 Ω	58 C/U, 141 A/U	124 C 21059 X	50 Ω	58 C/U, 141 A/U	123 C 21059 X
50 Ω	316 U *	124 C 21069 X	50 Ω	316 U *	123 C 21069 X

TYPE M

Coaxial contacts – angled – inner conductor solder – outer conductor crimp/solder termination



RoHS compliant

DESCRIPTION

- 50 and 75 Ω Version
- Socket contact suitable for male connectors
- Plug contact suitable for female connectors
- Contact platings:
 - 0.8µm gold mating side inner conductor
 - other platings on request
- Delivery includes: contacts and sleeve supplied loose

PRODUCT DRAWING

50 Ω Version

Socket contact

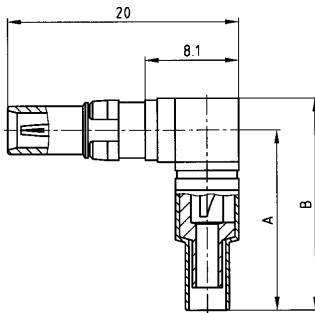

usable cable RG	A	B	ØD max.	ØE max.	ØF max.	ØG max.
178 B/U, 196 A/U, 404 U ⁺	15.7	18.5	0.90	1.2	1.4	2.3
174 U, 188 A/U, 316 U	15.7	18.5	0.90	1.9	2.3	3.2
122 U	15.7	18.5	0.90	2.8	3.1	4.5
316 U*	16.8	19.5	0.90	1.9	2.7	3.5
58 C/U, 141 A/U	18.0	20.8	0.90	3.0	4.1	5.2

* = double braided - ⁺ = low noise

Plug contact

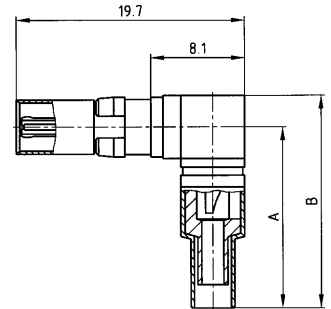

Wire stripping

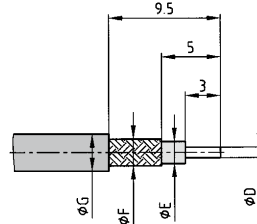

75 Ω Version

Socket contact

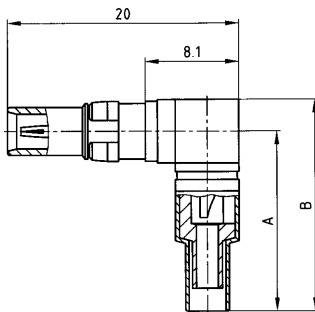

usable cable RG	A	B	ØD max.	ØE max.	ØF max.	ØG max.
196 A/U	15.7	18.5	0.90	1.2	1.4	2.3
179 B/U, 187 A/U	15.7	18.5	0.90	1.9	2.3	3.2
180 B/U	15.7	18.5	0.90	2.8	3.1	4.5

Plug contact

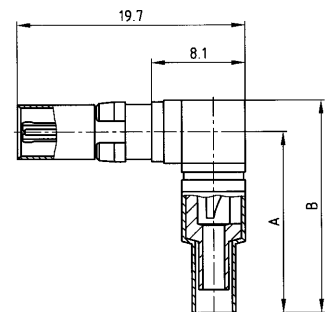

ORDER DATA

(Dim. = mm)

SOCKET CONTACT			PLUG CONTACT		
Version	Usable cable RG	Part number	Version	Usable cable RG	Part number
50 Ω	178 B/U, 196 A/U, 404 U ⁺	124 C 22069 X	50 Ω	178 B/U, 196 A/U, 404 U ⁺	123 C 22069 X
50 Ω	174 U, 188 A/U, 316 U	124 C 22079 X	50 Ω	174 U, 188 A/U, 316 U	123 C 22079 X
50 Ω	316 U *	124 C 22089 X	50 Ω	316 U *	123 C 22089 X
50 Ω	122 U	124 C 22099 X	50 Ω	122 U	123 C 22099 X
50 Ω	58 C/U, 141 A/U	124 C 22109 X	50 Ω	58 C/U, 141 A/U	123 C 22109 X
75 Ω	196 A/U	124 C 32049 X	75 Ω	196 A/U	123 C 32049 X
75 Ω	179 B/U, 187 A/U	124 C 32059 X	75 Ω	179 B/U, 187 A/U	123 C 32059 X
75 Ω	180 B/U	124 C 32069 X	75 Ω	180 B/U	123 C 32069 X

TYPE M

Coaxial contacts – angled – inner and outer conductor crimp termination



RoHS compliant

DESCRIPTION

- 50 Ω and 75 Ω Version
- Socket contact suitable for male connectors
- Plug contact suitable for female connectors
- Contact platings:
 - 0.8µm gold mating side inner conductor
 - other platings on request
- Delivery includes: contacts and sleeve supplied loose

PRODUCT DRAWING

50 Ω Version

usable cable RG	A	B	ØD max.	ØE max.	ØF max.	ØG max.
174 U, 188 A/U, 316 U	15.7	18.5	0.60	1.9	2.3	2.3
316 U*	15.7	18.5	0.60	1.9	3.0	3.8
58 C/U, 141 A/U	15.4	18.2	1.00	3.7	4.4	5.2

Socket contact

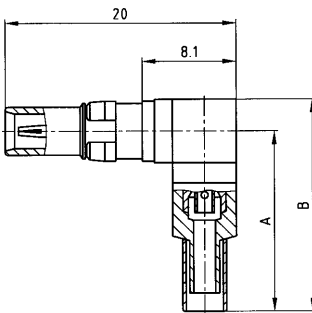

* = double braided

Wire stripping

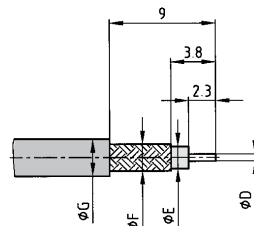

Plug contact

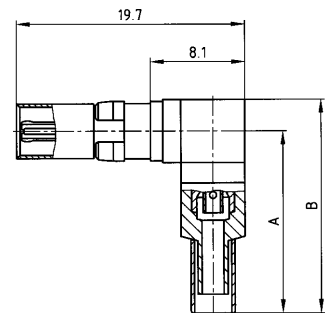

75 Ω Version

Socket contact

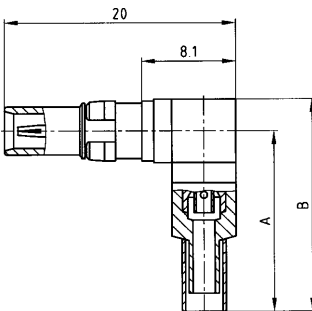

Plug contact

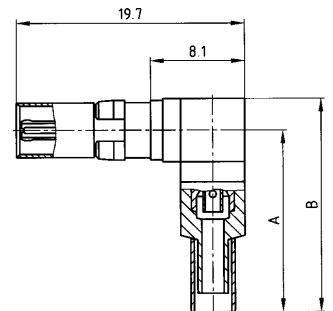

usable cable RG	A	B	ØD max.	ØE max.	ØF max.	ØG max.
179 B/U, 187 A/U	15.7	18.5	0.60	1.9	2.3	3.2
180 B/U	14.9	17.7	0.60	2.8	3.2	4.5

ORDER DATA

(Dim. = mm)

SOCKET CONTACT		
Version	Usable cable RG	Part number
50 Ω	174 U, 188 A/U, 316 U	124 C 23049 X
50 Ω	316 U *	124 C 23059 X
50 Ω	58 C/U, 141 A/U	124 C 23069 X
75 Ω	179 B/U, 187 A/U	124 C 33039 X
75 Ω	180 B/U	124 C 33049 X

PLUG CONTACT		
Version	Usable cable RG	Part number
50 Ω	174 U, 188 A/U, 316 U	123 C 23049 X
50 Ω	316 U *	123 C 23059 X
50 Ω	58 C/U, 141 A/U	123 C 23069 X
75 Ω	179 B/U, 187 A/U	123 C 33039 X
75 Ω	180 B/U	123 C 33049 X

TYPE M

Coaxial contacts – straight – PCB termination – 5 solder pins

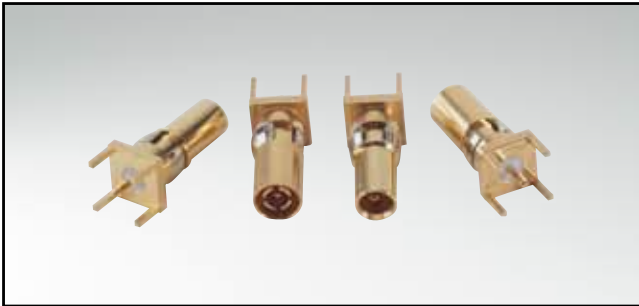

RoHS compliant

DESCRIPTION

- 50 and 75 Ω Version
- Socket contact suitable for male connectors
- Plug contact suitable for female connectors
- Contact platings:
 - 0.8µm gold mating side inner conductor
 - other platings on request

PRODUCT DRAWING

50 Ω Version

Socket contact

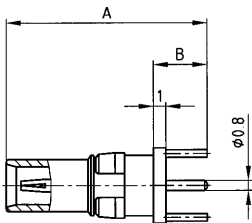

Termination type	A	B	C
31	16.2	4.3	16.0
32	17.7	5.8	17.5

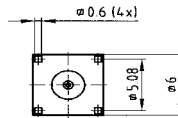

Plug contact

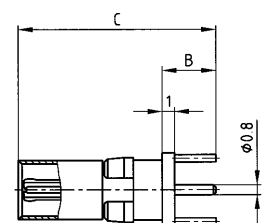

75 Ω Version

Socket contact

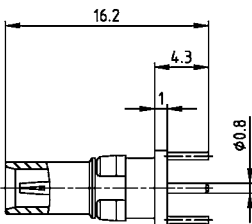

Plug contact

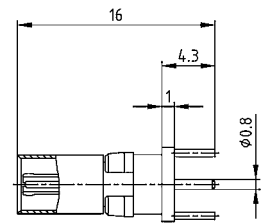

ORDER DATA

(Dim. = mm)

SOCKET CONTACT			PLUG CONTACT		
Version	Termination	Part number	Version	Termination	Part number
50 Ω	31	124 C 24039 X	50 Ω	31	123 C 24039 X
50 Ω	32	124 C 24049 X	50 Ω	32	123 C 24049 X
75 Ω	33	124 C 34029 X	75 Ω	33	123 C 34029 X

TYPE M

Coaxial contacts – angled – PCB termination – 5 solder pins

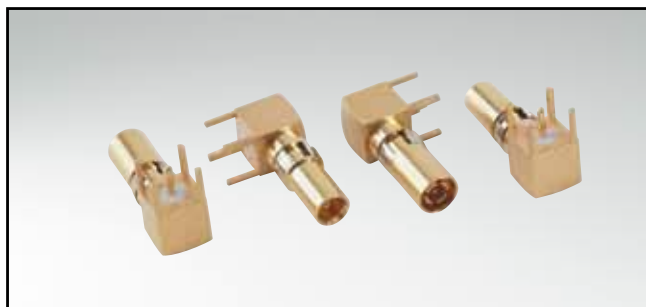

RoHS compliant

DESCRIPTION

- 50 and 75 Ω Version
- Socket contact suitable for male connectors
- Plug contact suitable for female connectors
- Contact platings:
 - 0.8µm gold mating side inner conductor
 - other platings on request

PRODUCT DRAWING

50 Ω Version

Socket contact

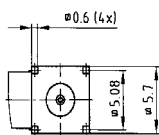
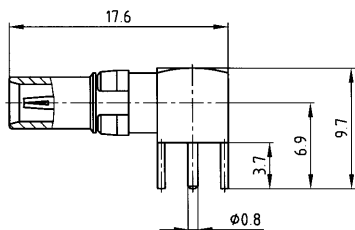

Plug contact

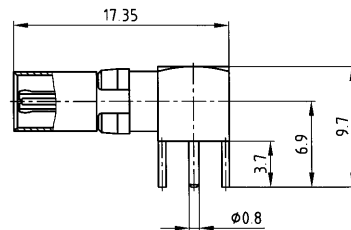

75 Ω Version

Socket contact

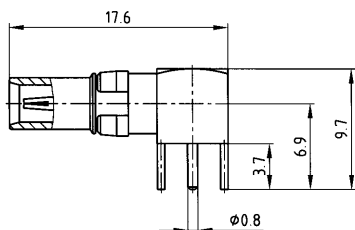

Plug contact

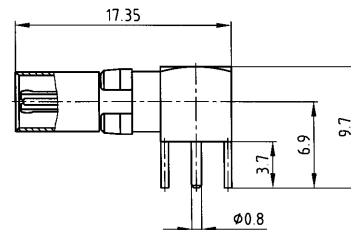

ORDER DATA

(Dim. = mm)

SOCKET CONTACT			PLUG CONTACT		
Version	Termination	Part number	Version	Termination	Part number
50 Ω	35	124 C 25029 X	50 Ω	35	123 C 25029 X
75 Ω	36	124 C 35029 X	75 Ω	36	123 C 35029 X

SECTION 6

PC104 AND PC104PLUS CONNECTORS

Numerous manufacturers now use these standards for system architecture. This has promoted the triumphant march of the "personal computer" to be carried over into the field of industrial production, in the form of IPCs (industrial personal computers).

Prerequisite for this was an adaptation of these well-known "office world" systems to the requirements and conditions prevailing in industrial production environments.

Among the most important development goals incorporated into the specifications were

- a compact form-factor of about 90 mm x 96 mm (3.6 x 3.8 inches) for individual, low-profile function modules,
- a universal, self-building bus system to achieve superior modularity and compatibility,
- the definition of a robust, reliable connector system capable of replacing the edge connectors common to the PC world,
- reduced power requirements for modules.

Realization of these goals has made it possible for today's industrial PCs to be deployed in the operating, programming, visualization, long-term archival and simulation of processes – and beyond this – they are capable of being combined with conventional industrial controllers or PLCs.

Specification-compliant bus connectors play a key role in PC104 and PC104plus system architecture interconnections.

In order to form a 104-pole ISA bus, the standard defines two, two-row connectors having a 2.54 mm contact grid; one connector with 64 contacts, the other with 40 contacts. These connectors must be located on the circuit board at prescribed positions.

In order to achieve a self-building system through the stacking of modules, these connectors are designed as "stack-through" and "non-stack-through" (terminating) connectors.

Stack through connectors have 12.2 mm and 17.0 mm long contacts and they function both as a pin connector and as a socket connector for signals routed from level-to-level in the module stack.

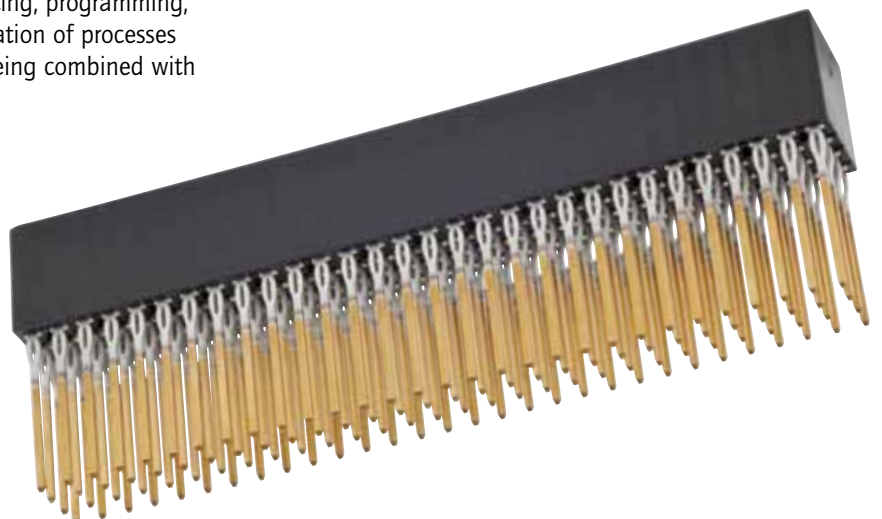



Press-fit contacts are the preferred technology for circuit board stack-through connectors. Terminating connectors with short contacts are used on the first stack level. These are often available either as solder or press-fit versions.

The PC104plus specification defines a connector for implementing a PCI bus. It is a 4 x 30 positions connector with a 2.00 mm contact grid pattern.

Because of the smaller grid spacing and increased contact density exhibited by these connectors, the specification describes an additional shroud that is to be plugged onto the circuit board's underside. This shroud stabilizes the stack-through contacts and ensures they are properly guided when modules are stacked.

PC104 and PC104plus connectors are specified to be compatible so that a mix of modules, compliant with either specification, can be used together in a single system configuration— which is often the case.

CONEC uses for its PC104 and PC104plus connectors a flexible press fit termination. This Eye of the needle design preserves the circuit board during the press-fit process and it ensures good retention force for the mounted component.



TECHNICAL DATA

PC104 Connectors

Materials	
Insulator	PBT, GF, UL94 V-0
Contacts	Copper alloy

Electrical Characteristics	
Current rating	2.2 A in acc. to IEC 60512-5-2
Contact resistance	< 20 mΩ
Working temperature	-55°C to +95°C

Mechanical characteristics	
Mating force	max. 0.9 N/Pin with test Pin Ø 0.6 mm
Withdrawal force	min. 0.3 N/Pin with test Pin Ø 0.6 mm
Press-in force	max. 80 N/Pin
PCB thickness	1.6 mm
Creepage distance	min. 1.2 mm

Technical alterations are subjects to change without notice.

Derating curve 100-pos. connector – all contacts loaded

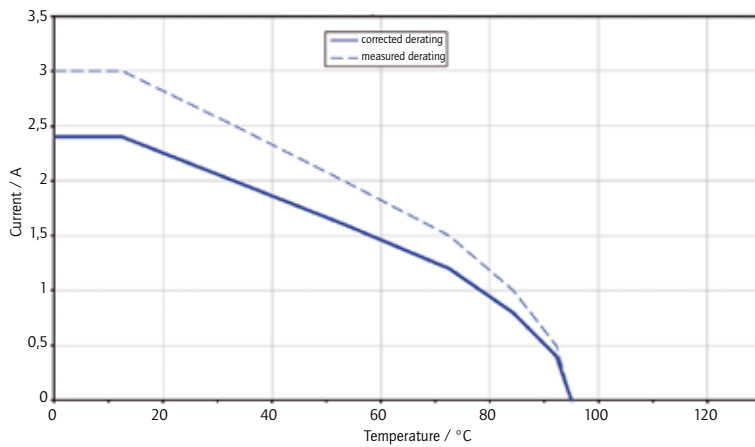

Derating curve 64-pos. connector – contacts loaded in acc. to PC104 specification

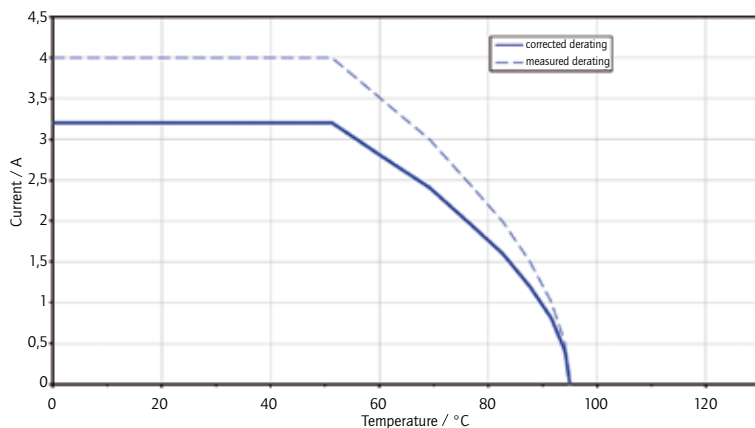

TECHNICAL DATA

PC104plus Connectors

Materials	
Insulator	PBT, GF, UL94 V-0
Contacts	Copper alloy

Electrical Characteristics	
Current rating	1 A ref. IEC 60512-5-2
Contact resistance	< 20 mΩ
Working temperature	-55°C to +95°C

Mechanical characteristics	
Mating force	max. 1.5 N / Pin with test Pin Ø 0.5 mm
Withdrawal force	min. 0.3 N / Pin with test Pin Ø 0.5 mm
Press-in force	max. 80 N / Pin
PCB thickness	1.4 mm
Creepage distance	min. 0.6 mm

Technical alterations are subjects to change without notice.

Derating curve 120-pos. connector – all contacts loaded

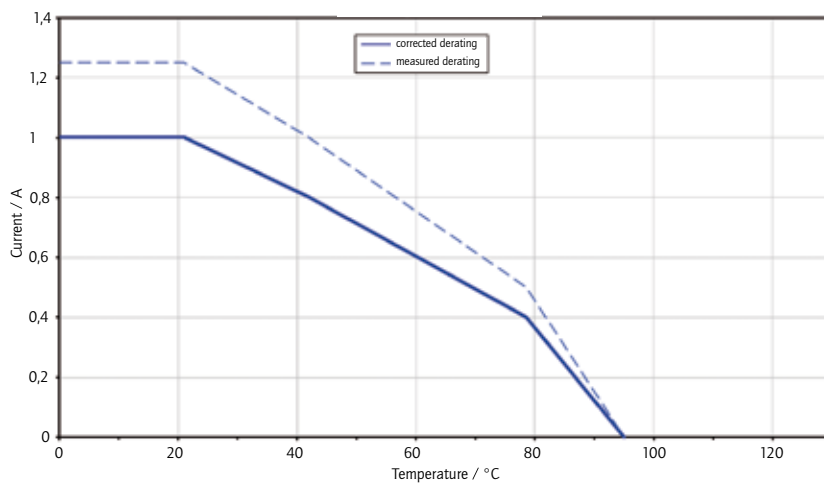

Derating curve 120-pos. connector – contacts loaded in acc. to PC104 specification

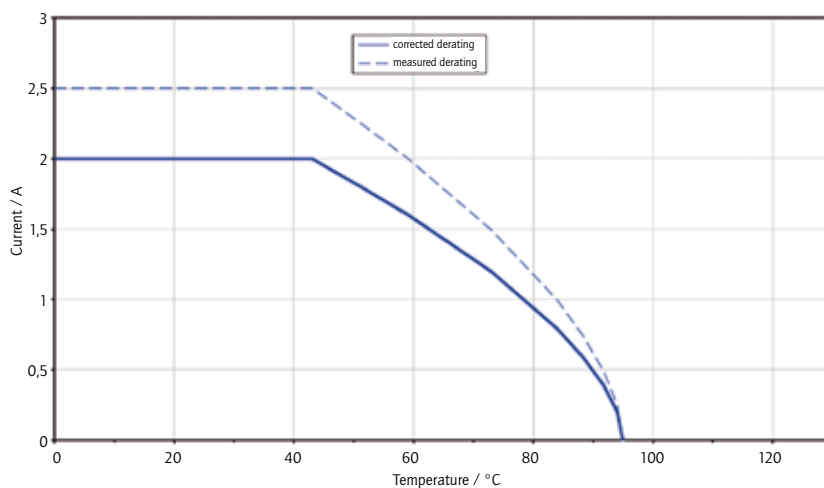

PC104 STACK-THROUGH VERSION

Female connector – straight – press fit contact – contact length 12.2 mm

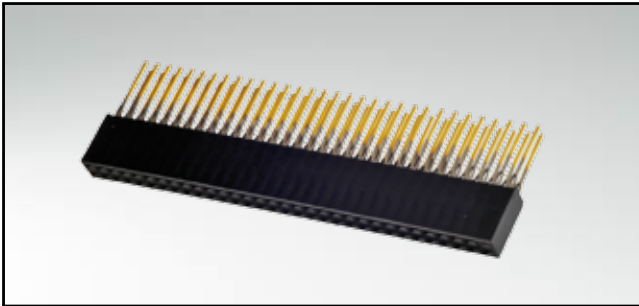

RoHS compliant

DESCRIPTION

- Standard version for PC104 module height 15.0 mm
- Flexible press fit design
- Double beam contacts
- 40 / 64 / 100 positions version (further versions on request)
- Quality class 3 and alternative quality class 2 available on request
- Delivered as a set with "spacer"

PRODUCT DRAWING

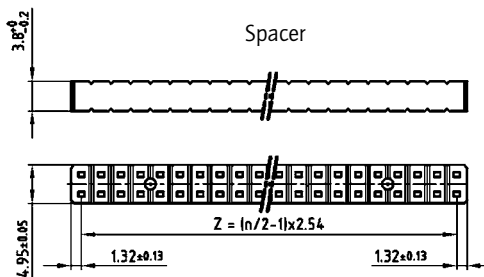
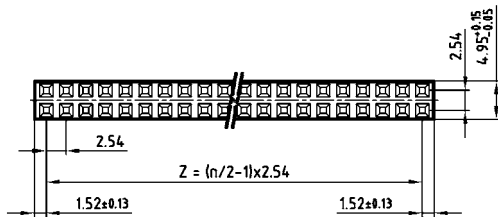
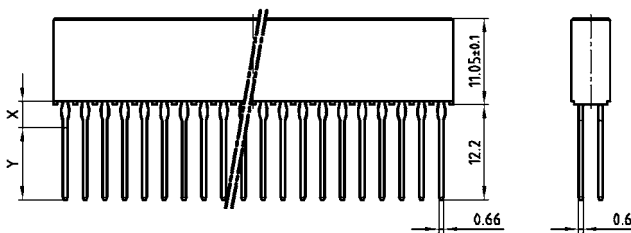

PCB-hole pattern

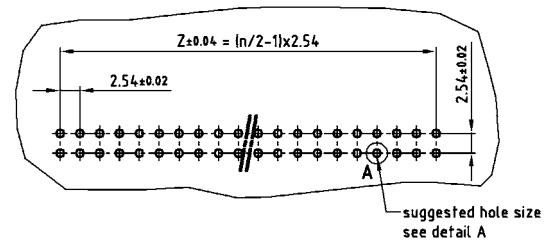

Quality Class	Plating		
	Mating Area	Post Area "X"	Post Area "Y"
3	0.25 µm Au	1.3 µm Sn 100 matt	0.10 µm Au
2	0.40 µm Au	1.3 µm Sn 100 matt	0.25 µm Au

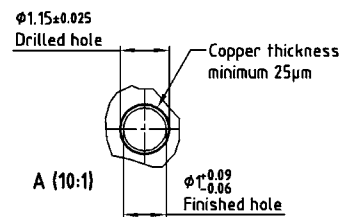

ORDER DATA

(Dim. = mm)

Number of positions	Quality class 3	Quality class 2
40	49-000023	49-000022
64	49-000103	49-000102
100	49-000143	49-000142

PC104 STACK-THROUGH VERSION

Female connector – straight – press fit contact – contact length 17 mm

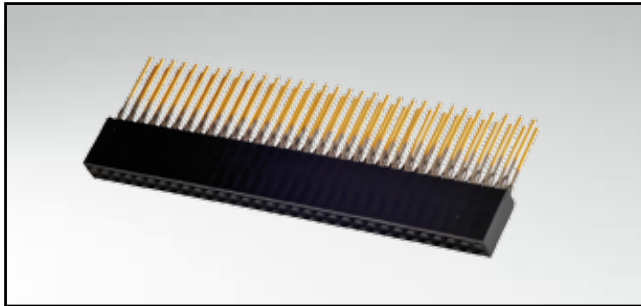

RoHS compliant

DESCRIPTION

- Special contact length to achieve higher module stacks
- Flexible press fit design
- Double beam contacts
- 40/64/100 positions version (further versions on request)
- Quality class 3 and alternative quality class 2 available on request
- Delivered as a set with "spacer"

PRODUCT DRAWING

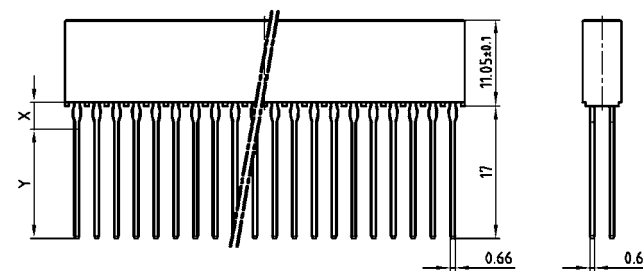

PCB-hole pattern

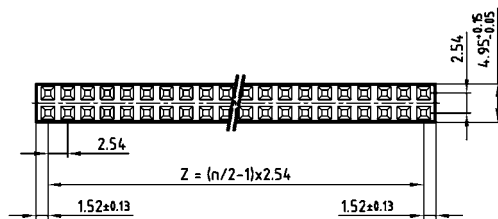
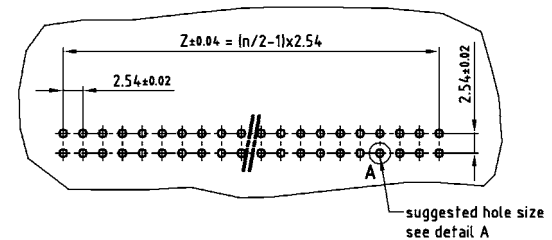

Quality Class	Plating		
	Mating Area	Post Area "X"	Post Area "Y"
3	0.25 µm Au	1.3 µm Sn 100 matt	0.10 µm Au
2	0.40 µm Au	1.3 µm Sn 100 matt	0.25 µm Au

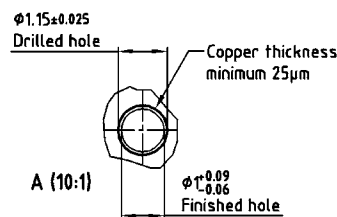
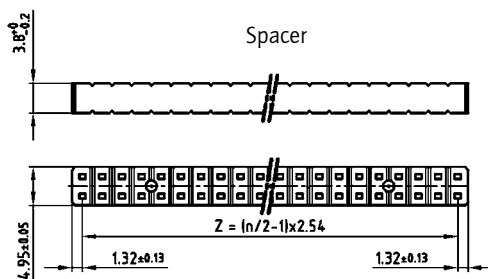

ORDER DATA

(Dim. = mm)

Number of positions	Quality class 3	Quality class 2
40	49-000033	49-000032
64	49-000113	49-000112
100	49-000153	49-000152

PC104 Non-Stack-Through Version

Female connector – straight – press fit contact – contact length 3.4 mm

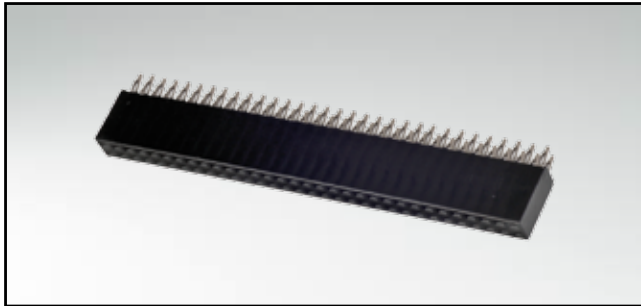

RoHS compliant

DESCRIPTION

- Flexible press fit design
- Double beam contacts
- 40/64/100 positions version (further versions on request)
- Quality class 3 and alternative quality class 2 available on request

PRODUCT DRAWING

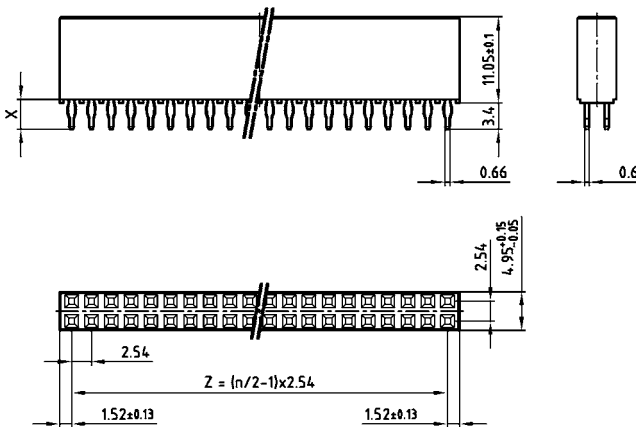

PCB-hole pattern

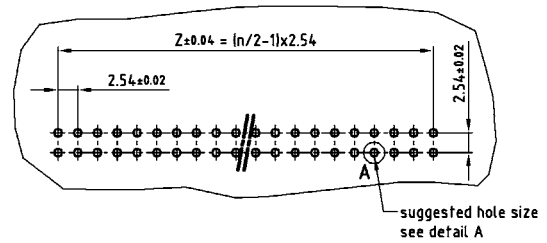

Quality Class	Plating	
	Mating Area	Post Area "X"
3	0.25 µm Au	1.3 µm Sn 100 matt
2	0.40 µm Au	1.3 µm Sn 100 matt

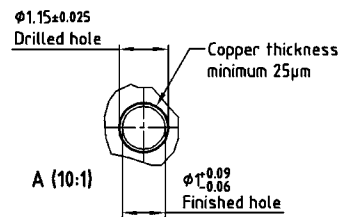

ORDER DATA

(Dim. = mm)

Number of positions	Quality class 3	Quality class 2
40	49-000013	49-000012
64	49-000093	49-000092
100	49-000133	49-000132

PC104 NON-STACK-THROUGH VERSION

Female connector – straight – solder pin – contact length 3.4 mm

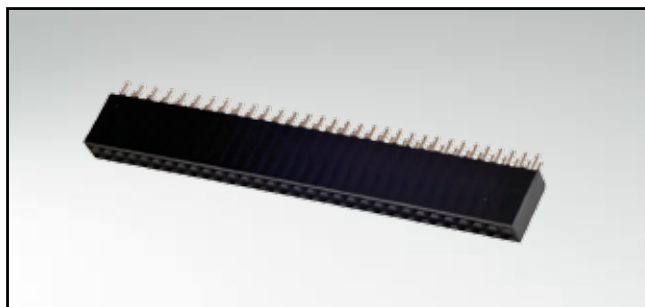

RoHS compliant

DESCRIPTION

- Double beam contacts
- 40/64/100 positions version (further versions on request)
- Quality class 3 and alternative quality class 2 available on request

PRODUCT DRAWING

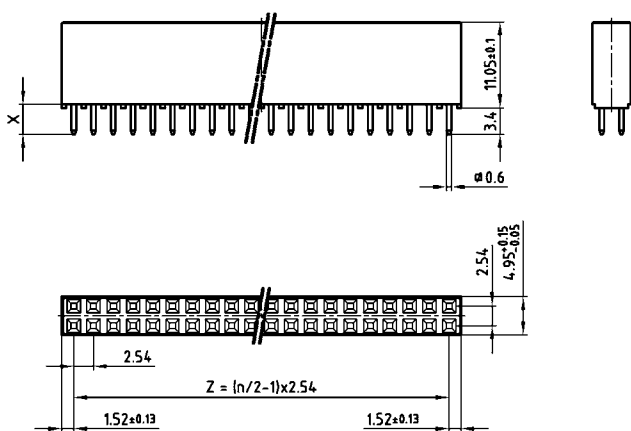

PCB-hole pattern

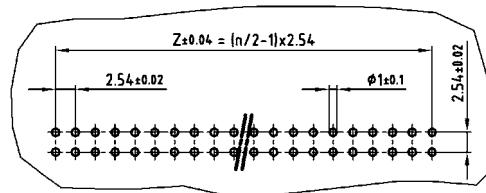

Quality Class	Plating	
	Mating Area	Post Area "X"
3	0.25 μ m Au	1.3 μ m Sn 100 matt
2	0.40 μ m Au	1.3 μ m Sn 100 matt

ORDER DATA

(Dim. = mm)

Number of positions	Quality class 3	Quality class 2
40	49-000043	49-000042
64	49-000123	49-000122
100	49-000163	49-000162

PC104PLUS STACK-THROUGH VERSION

Female connector – straight – press fit contact – contact length 12.2 mm

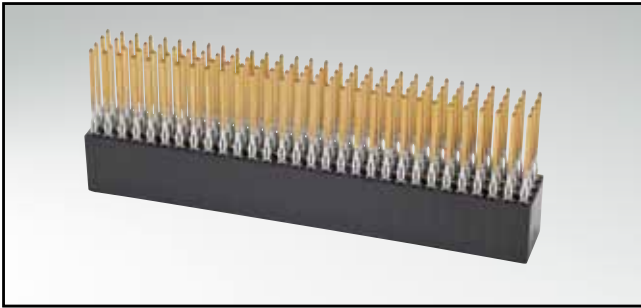

RoHS compliant

DESCRIPTION

- Flexible press fit design
- Double beam contacts
- Standard version 120 positions
- Quality class 3 and alternative quality class 2 available on request

PRODUCT DRAWING

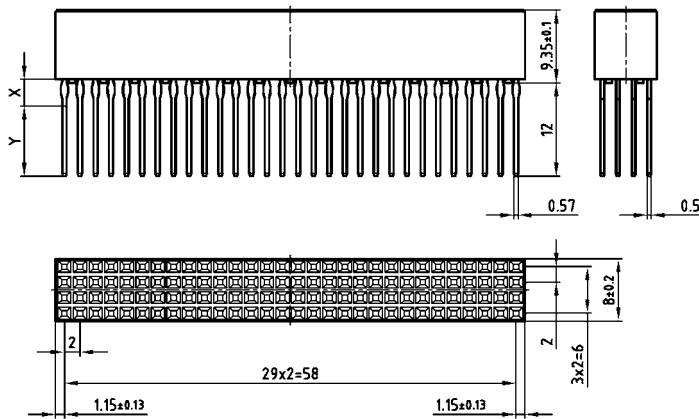

PCB-hole pattern

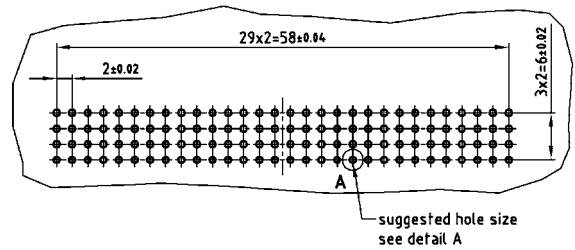

Quality Class	Plating		
	Mating Area	Post Area "X"	Post Area "Y"
3	0.25 µm Au	1.3 µm Sn 100 matt	0.10 µm Au
2	0.40 µm Au	1.3 µm Sn 100 matt	0.25 µm Au

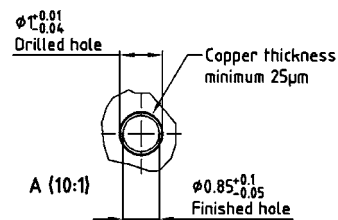

ORDER DATA

(Dim. = mm)

Number of positions	Quality class 3	Quality class 2
120	49-100023	49-100022

PC104PLUS NON-STACK-THROUGH VERSION

Female connector – straight – press fit contact – contact length 3.0 mm

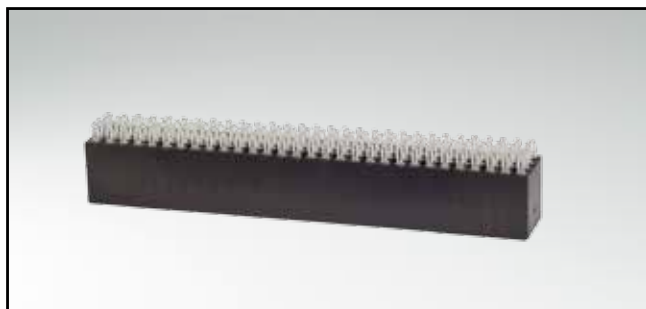

RoHS compliant

DESCRIPTION

- Flexible press fit design
- Double beam contacts
- Standard version 120-position
- Quality class 3 and alternative quality class 2 available on request

PRODUCT DRAWING

PCB-hole pattern

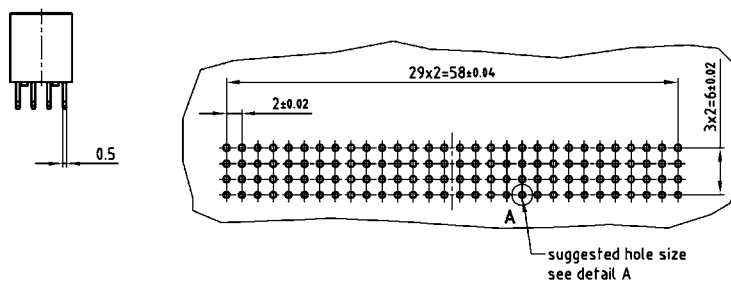
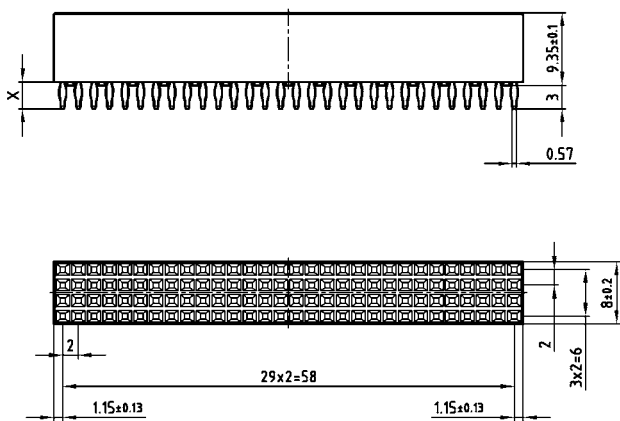

Quality Class	Plating	
	Mating Area	Post Area "X"
3	Underplate min. 1.3 µm Ni 0.25 µm Au	1.3 µm Sn 100 matt
2	0.40 µm Au	1.3 µm Sn 100 matt

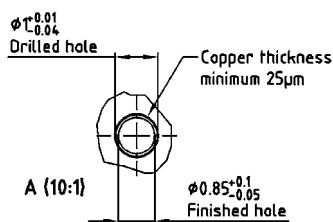

ORDER DATA

(Dim. = mm)

Number of positions	Quality class 3	Quality class 2
120	49-100013	49-100012

PC104PLUS NON-STACK-THROUGH VERSION

Female connector – straight – solder pin – contact length 3.0 mm

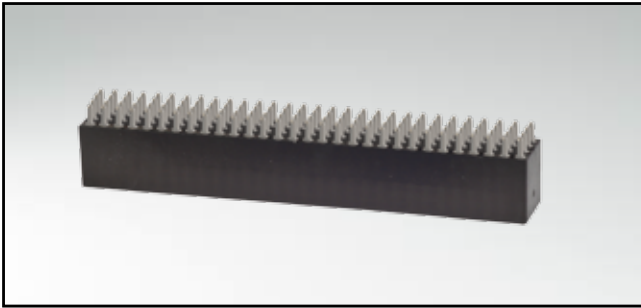

RoHS compliant

DESCRIPTION

- Double beam contacts
- Standard version 120-position
- Standard finishing quality class 2, alternative quality class 3

PRODUCT DRAWING

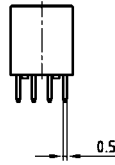
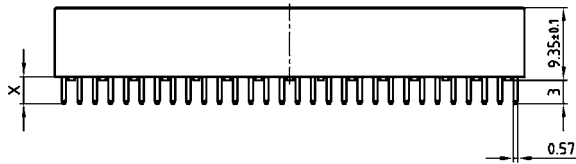

PCB-hole pattern

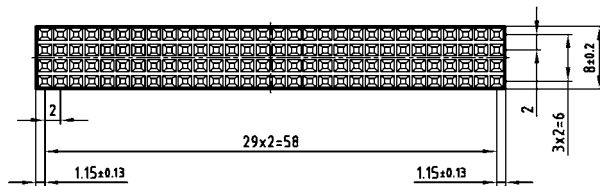
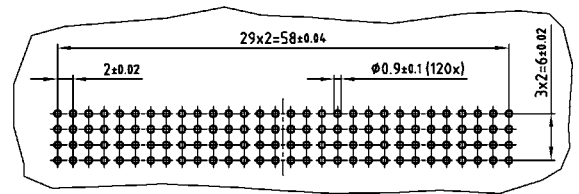

Quality Class	Plating	
	Mating Area	Post Area "X"
3	0.25 μm Au	1.3 μm Sn 100 matt
2	0.40 μm Au	1.3 μm Sn 100 matt

ORDER DATA

(Dim. = mm)

Number of positions	Quality class 3	Quality class 2
120	49-100003	49-100002

PC104 UND PC104PLUS ACCESSORIES

Spacer and interconnection housing "shroud"



RoHS compliant

DESCRIPTION

Spacer

- Can be ordered separately
- 40/64/100 positions version (further positions on request)

Interconnection housing (shroud)

- Specific shroud to stabilize and guide stack-through contacts
- Available with and without positioning
- Color is black (further colors on request)

PRODUCT DRAWING

Interconnection housing for PC104plus

Spacer for PC104

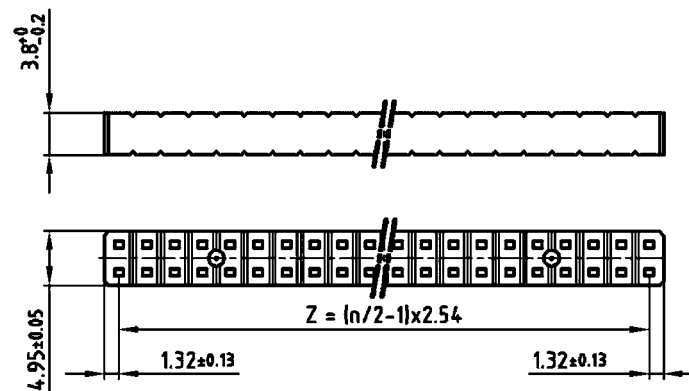
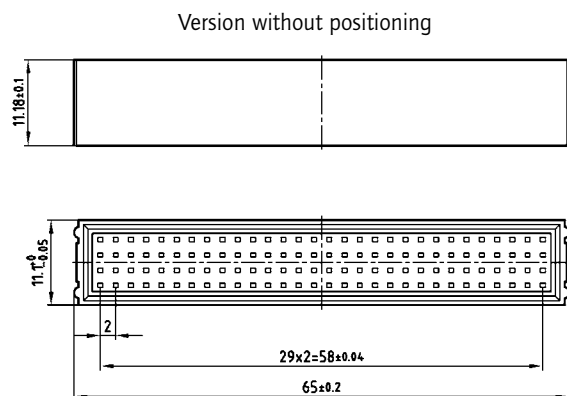

Version with positioning

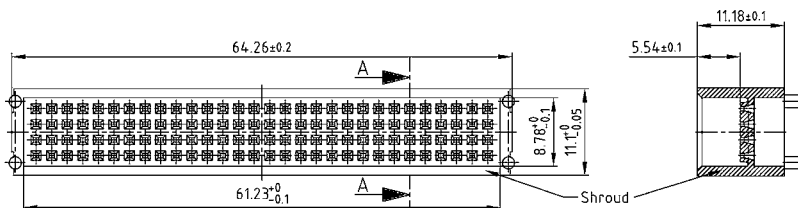

(Dim. = mm)

ORDER DATA

INTERCONNECTION HOUSING PC104PLUS		
No. of Pos.	Design	Part number
120	with positioning	49-100030
120	without positioning	49-100040

SPACER FOR PC104	
Number of positions	Part number
40	49-100080
64	49-100060
100	49-100050

SECTION 7

CONNECTORS DIN 41617

This traditional connector is still being used in many applications. New designs as well as redesigns of existing systems are manufactured with this series of connectors.

One reason is the proven solid design and the high current carrying capability.

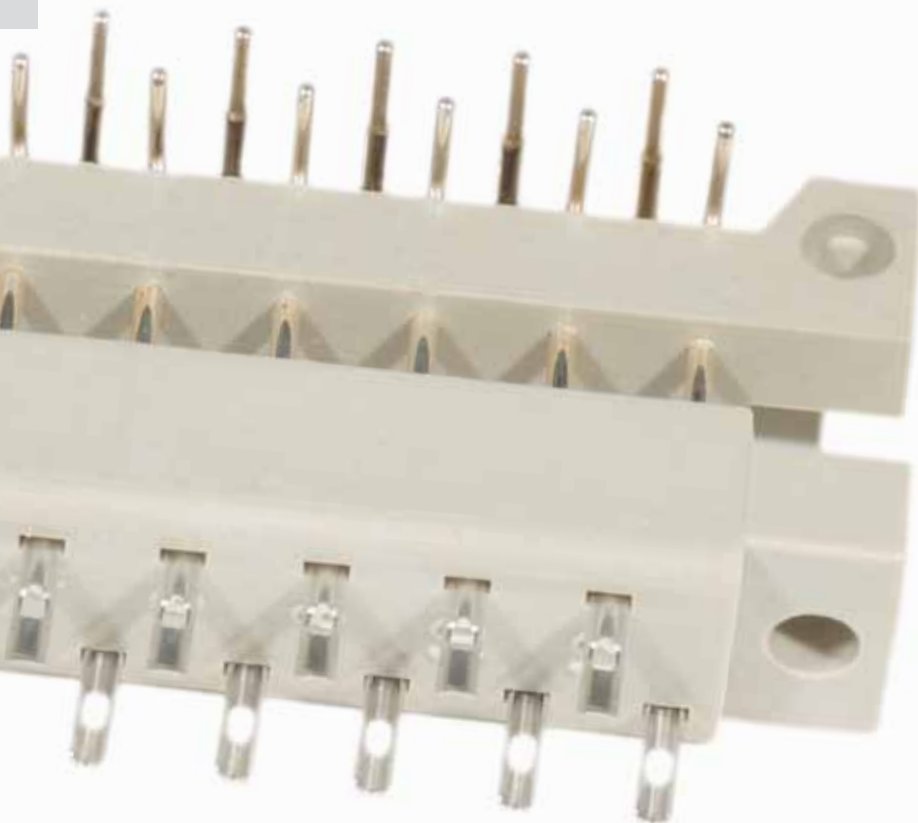



The connector is available in three layouts:
13, 21 and 31 positions in male and female
version with gold or silver plated contacts.
Available termination styles are: solder cup,
straight and right angled PCB solder tails.

In addition a connector converter from
DIN 41617 to DIN EN 60603-2 provides
adaptability to the newer connector series.



TECHNICAL DATA

Material		DIN 41617	DIN 41617 / DIN EN 60603
Insulator		Polycarbonat GF	
Contacts		Copper alloy	
Flammability		UL 94 V-1	
Initial contact resistance		≤ 15 mΩ	≤ 10 mΩ
Initial insulation resistance	Quality class 1	≥ 10 ¹² Ω	≥ 10 ¹¹ Ω
	Quality class 2	≥ 10 ¹¹ Ω	
	Quality class 3	≥ 10 ¹⁰ Ω	
Creepage distance	Contact-Ground	≥ 1 mm	≥ 1.2 mm
	Contact-Contact	≥ 0.5 mm	
Clearance distance	Contact-Ground	≥ 1 mm	≥ 1.2 mm
	Contact-Contact	≥ 1 mm	
Voltage Proof U eff.	Contact-Ground	900 V	1000 V
	Contact-Contact	1150 V	1550 V
Working voltage		250 V depending on insulation coordination (refer to DIN VDE 0110/IEC 664-1)	
Working current	+ 20 °C	Quality class 1 + 2 = 4 A max.	
	+ 70 °C	Quality class 3 = 2 A max.	
	+ 100 °C		
Working temperature	Quality class 1	-65 °C to +125 °C	
	Quality class 2	-55 °C to +125 °C	
	Quality class 3	-25 °C to + 85 °C	
Mating and unmating forces (F max.)	13 pos.	32 N/AU	30 N/AG
	21 pos.	33 N/AU	48 N/AG
	31 pos.	48 N/AU	70 N/AG
		31 + 1 pos. 80 N	
Quality class 3	50 cycles		50 cycles
Quality class 2	400 cycles		400 cycles
Quality class 1	500 cycles		500 cycles
Silver plating		500 cycles	

Technical alterations are subjects to change without notice.

Derating-Diagramm DIN 41617

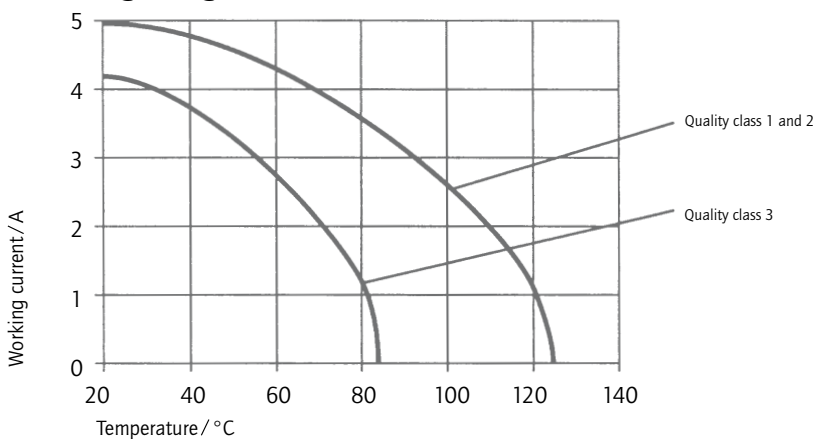

CONNECTOR ACCORDING TO DIN 41617

Male connector – solder lug – 13, 21 and 31 positions

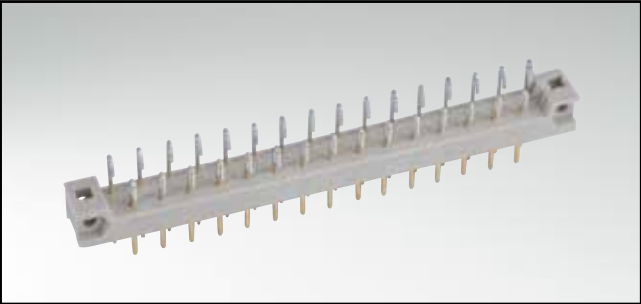

RoHS compliant

DESCRIPTION

- Solder lug
- Contact plating
 - standard quality classes 3 and 2
 - quality class 1 on request (*)
 - hard silver plated
- Special insulator

PRODUCT DRAWING

Panel cutout

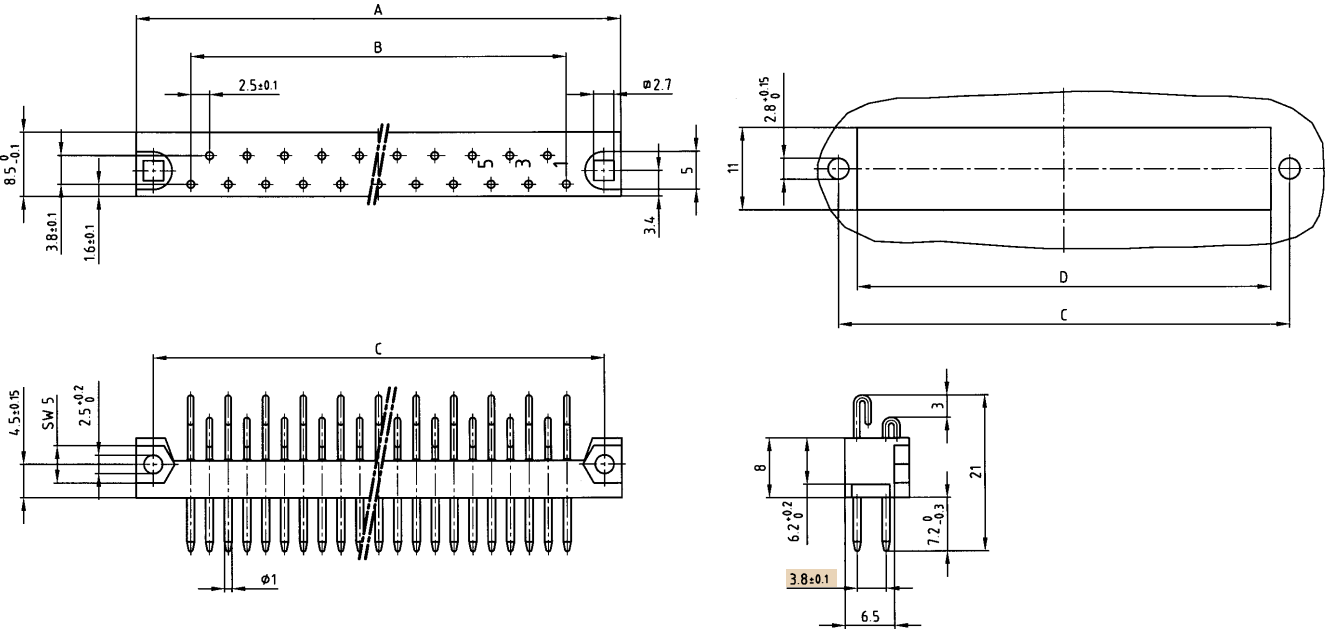

No. of Pos.	A ±0.2	B ±0.1	C ±0.1	D
13	44.6	12x2.5=30	40	35
21	64.6	20x2.5=50	60	55
31	89.6	30x2.5=75	85	80

ORDER DATA

(Dim. = mm)

No. of Pos.	hard silver plated	Quality class 3	Quality class 2	Quality class 1*
13	101 E 10139 X	101 A 10139 X	101 B 10139 X	101 C 10139 X
21	101 E 10149 X	101 A 10149 X	101 B 10149 X	101 C 10149 X
31	101 E 10159 X	101 A 10159 X	101 B 10159 X	101 C 10159 X

CONNECTOR ACCORDING TO DIN 41617

Male connector – straight – 13, 21 and 31 positions

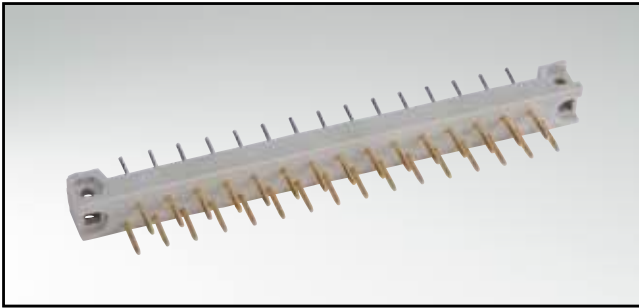

RoHS compliant

DESCRIPTION

- Solder pin
- Contact plating
 - standard quality classes 3 and 2
 - quality class 1 on request (*)
 - hard silver plated
- **Special insulator**

PRODUCT DRAWING

PCB-hole pattern

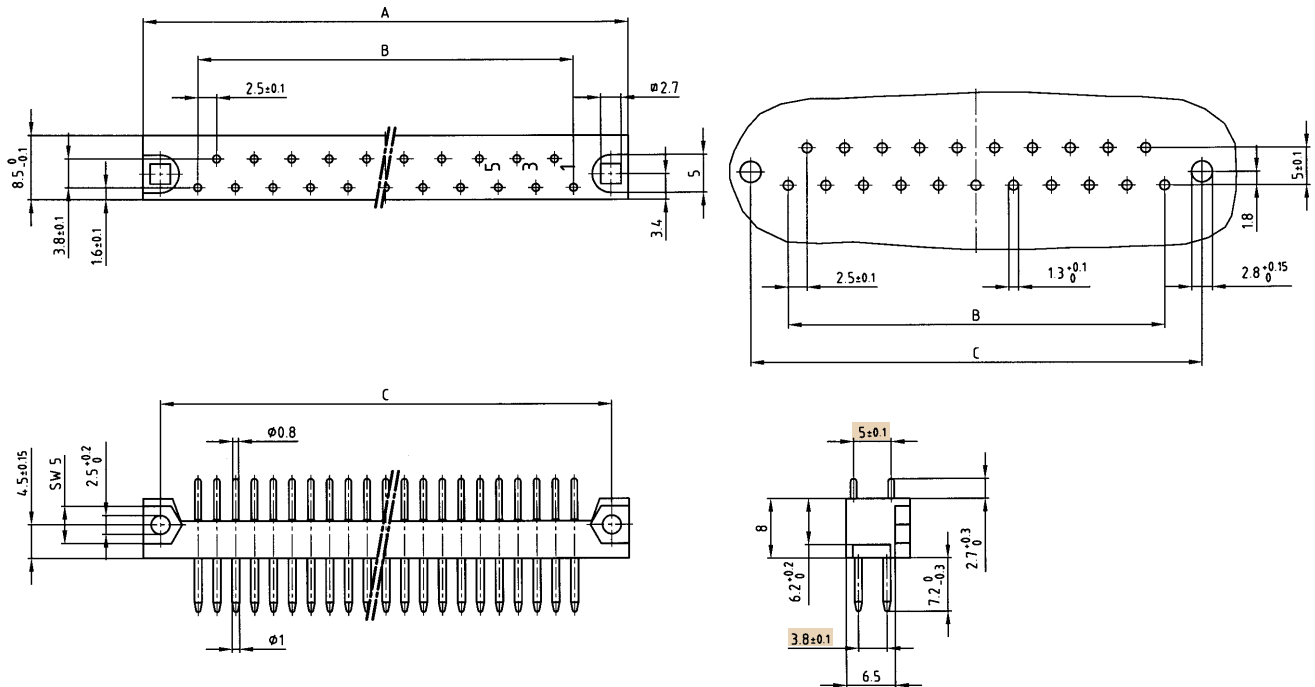

No. of Pos.	A ^{+0.2}	B ^{+0.1}	C ^{+0.1}
13	44.6	12x2.5=30	40
21	64.6	20x2.5=50	60
31	89.6	30x2.5=75	85

ORDER DATA

(Dim. = mm)

No. of Pos.	hard silver plated	Quality class 3	Quality class 2	Quality class 1*
13	101 E 10019 X	101 A 10019 X	101 B 10019 X	101 C 10019 X
21	101 E 10029 X	101 A 10029 X	101 B 10029 X	101 C 10029 X
31	101 E 10039 X	101 A 10039 X	101 B 10039 X	101 C 10039 X

CONNECTOR ACCORDING TO DIN 41617

Male connector – angled – 13, 21 and 31 positions

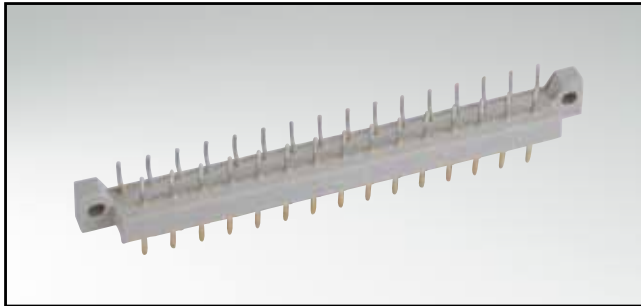

RoHS compliant

DESCRIPTION

- Solder pin
- Contact plating
 - standard quality classes 3 and 2
 - quality class 1 on request (*)
 - hard silver plated
- Standard insulator

PRODUCT DRAWING

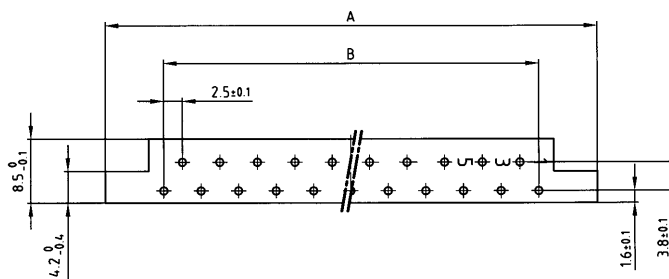

PCB-hole pattern

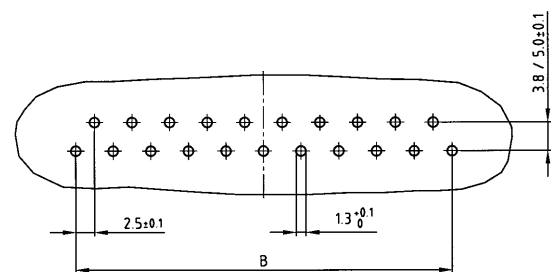

Contact spacing

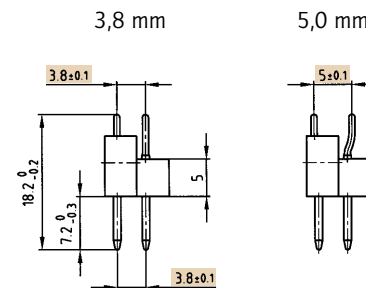
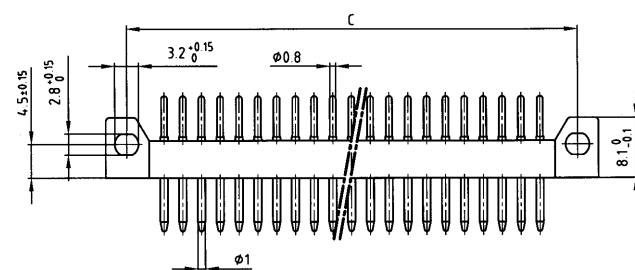

No. of Pos.	A ±0.2	B ±0.1	C ±0.1
13	45.6	12x2.5=30	40
21	65.6	20x2.5=50	60
31	89.6	30x2.5=75	85

ORDER DATA

(Dim. = mm)

No. of Pos.	Contact spacing	hard silver plated	Quality class 3	Quality class 2	Quality class 1 *
13	3.8 mm	101 E 10049 X	101 A 10049 X	101 B 10049 X	101 C 10049 X
13	5.0 mm	101 E 10169 X	101 A 10169 X	101 B 10169 X	101 C 10169 X
21	3.8 mm	101 E 10059 X	101 A 10059 X	101 B 10059 X	101 C 10059 X
21	5.0 mm	101 E 10179 X	101 A 10179 X	101 B 10179 X	101 C 10179 X
31	3.8 mm	101 E 10069 X	101 A 10069 X	101 B 10069 X	101 C 10069 X
31	5.0 mm	101 E 10189 X	101 A 10189 X	101 B 10189 X	101 C 10189 X

CONNECTOR ACCORDING TO DIN 41617

Male connector – angled – 13, 21 and 31 positions

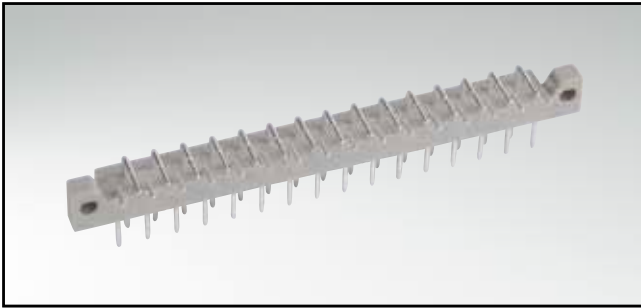

RoHS compliant

DESCRIPTION

- Solder pin
- Contact plating
 - standard quality classes 3 and 2
 - quality class 1 on request (*)
 - hard silver plated
- Standard insulator

PRODUCT DRAWING

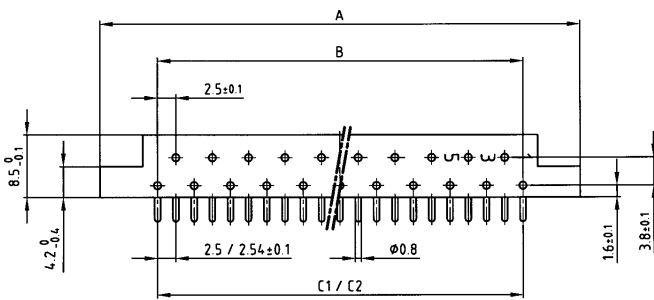

PCB-hole pattern

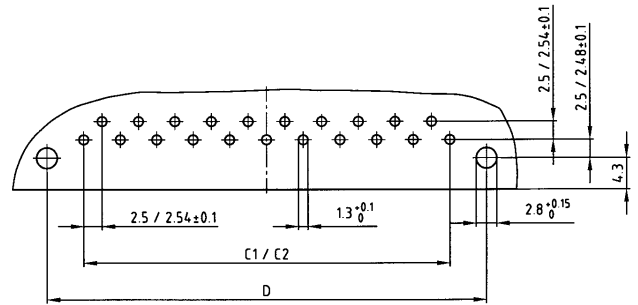

Contact spacing

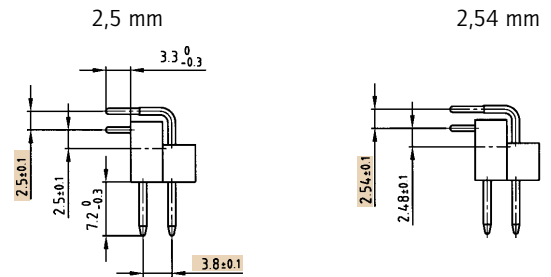
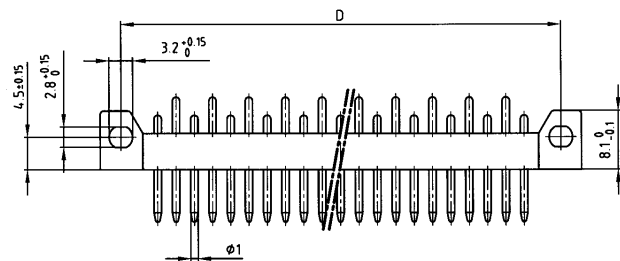

No. of Pos.	A ±0.2	B ±0.1	C ₁ ±0.1	C ₂ ±0.1	D ±0.1
13	45.6	12x2.5=30	12x2.5=30	12x2.54=30.48	40
21	65.6	20x2.5=50	20x2.5=50	20x2.54=50.80	60
31	90.6	30x2.5=75	30x2.5=75	30x2.54=75.20	85

ORDER DATA

(Dim. = mm)

No. of Pos.	Contact spacing	hard silver plated	Quality class 3	Quality class 2	Quality class 1 *
13	2.50 mm	101 E 10079 X	101 A 10079 X	101 B 10079 X	101 C 10079 X
13	2.54 mm	101 E 10089 X	101 A 10089 X	101 B 10089 X	101 C 10089 X
21	2.50 mm	101 E 10099 X	101 A 10099 X	101 B 10099 X	101 C 10099 X
21	2.54 mm	101 E 10109 X	101 A 10109 X	101 B 10109 X	101 C 10109 X
31	2.50 mm	101 E 10119 X	101 A 10119 X	101 B 10119 X	101 C 10119 X
31	2.54 mm	101 E 10129 X	101 A 10129 X	101 B 10129 X	101 C 10129 X

CONNECTOR ACCORDING TO DIN 41617

Female connector – solder lug – 13, 21 and 31 positions

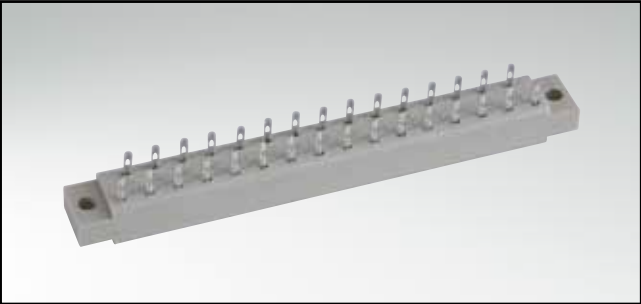

RoHS compliant

DESCRIPTION

- Solder lug
- Contact plating
 - standard quality classes 3 and 2
 - quality class 1 on request (*)
 - hard silver plated

PRODUCT DRAWING

Panel cutout

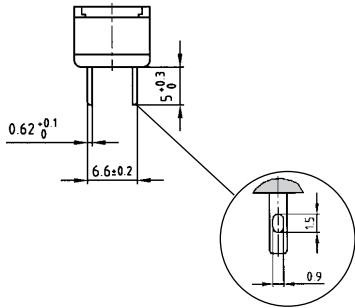
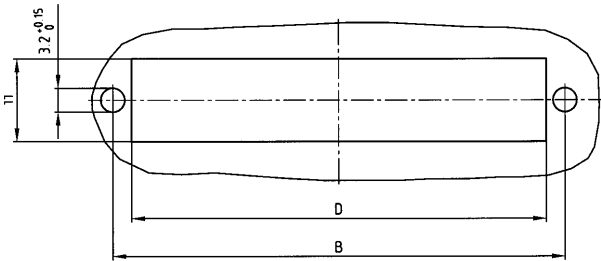
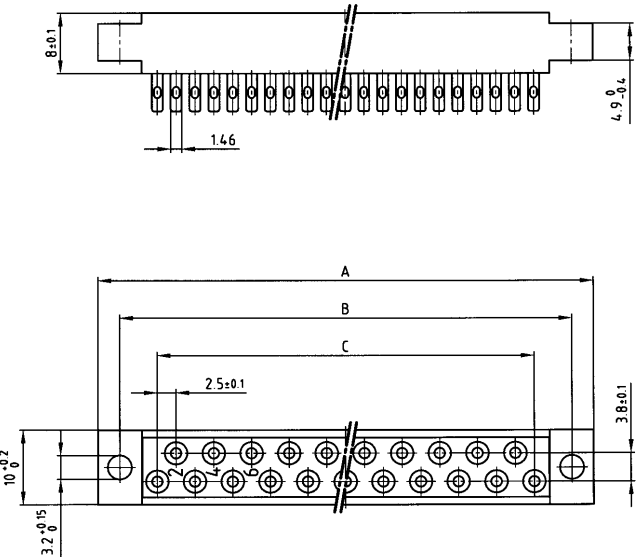

No. of Pos.	A ±0.3	B ±0.1	C ±0.1	D
13	45.8	40	12x2.5=30	35
21	65.8	60	20x2.5=50	55
31	90.8	85	30x2.5=75	80

ORDER DATA

(Dim. = mm)

No. of Pos.	hard silver plated	Quality class 3	Quality class 2	Quality class 1*
13	102 E 10019 X	102 A 10019 X	102 B 10019 X	102 C 10019 X
21	102 E 10029 X	102 A 10029 X	102 B 10029 X	102 C 10029 X
31	102 E 10039 X	102 A 10039 X	102 B 10039 X	102 C 10039 X

CONNECTOR ACCORDING TO DIN 41617

Female connector – straight – 13, 21 and 31 positions

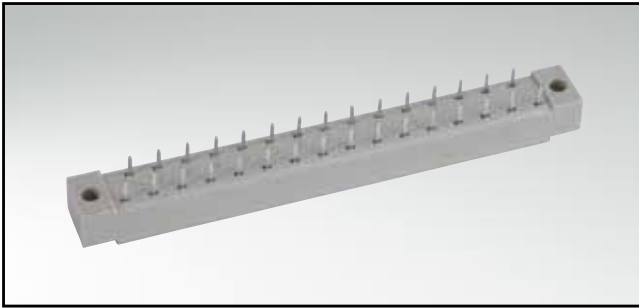

RoHS compliant

DESCRIPTION

- Solder pin
- Insulator "set up" (A) or "connected" (D)
- Contact plating
 - standard quality classes 3 and 2
 - quality class 1 on request (*)
 - hard silver plated

PRODUCT DRAWING

PCB-hole pattern

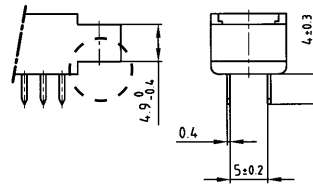
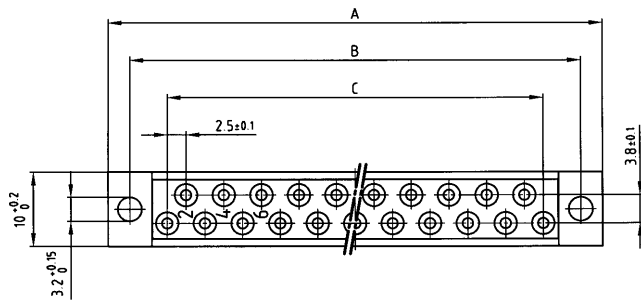
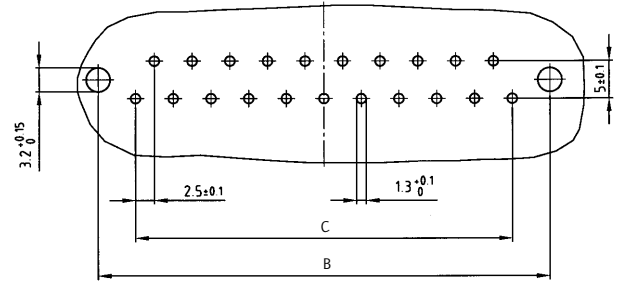
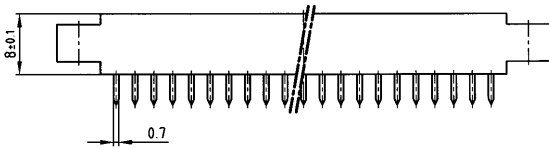

Version A
"set up"

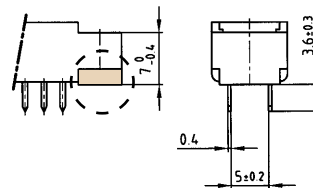

Version D
"connected"

No. of Pos.	A -0.3	B ±0.1	C ±0.1
13	45.8	40	12x2.5=30
21	65.8	60	20x2.5=50
31	90.8	85	30x2.5=75

ORDER DATA

(Dim. = mm)

No. of Pos.	Insulator	hard silver plated	Quality class 3	Quality class 2	Quality class 1 *
13	Version A	102 E 10049 X	102 A 10049 X	102 B 10049 X	102 C 10049 X
13	Version D	102 E 10059 X	102 A 10059 X	102 B 10059 X	102 C 10059 X
21	Version A	102 E 10069 X	102 A 10069 X	102 B 10069 X	102 C 10069 X
21	Version D	102 E 10079 X	102 A 10079 X	102 B 10079 X	102 C 10079 X
31	Version A	102 E 10089 X	102 A 10089 X	102 B 10089 X	102 C 10089 X
31	Version D	102 E 10099 X	102 A 10099 X	102 B 10099 X	102 C 10099 X

CONNECTOR ACCORDING TO DIN 41617 / DIN EN 60603-2

Converter female connector – 31 / 32 positions

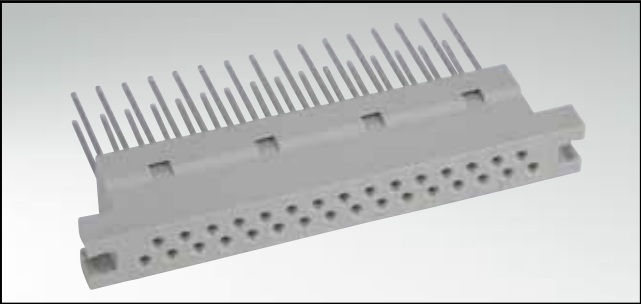

RoHS compliant

DESCRIPTION

- Wire Wrap and solder lug
- Quality class 1 (Standard)
- Mating side with 31 contacts
- Connecting side with 32 contacts (one contact not contacted)

PRODUCT DRAWING

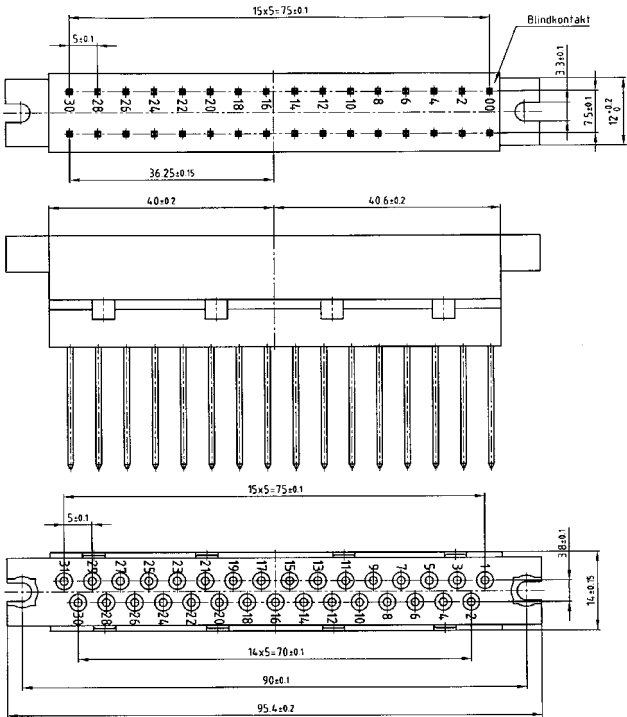

Panel cutout

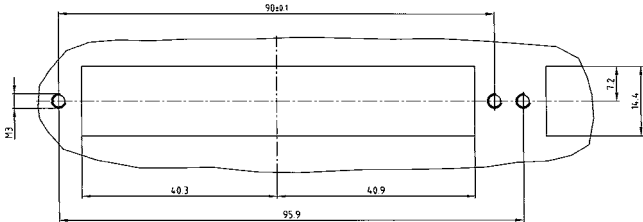

Solder lug

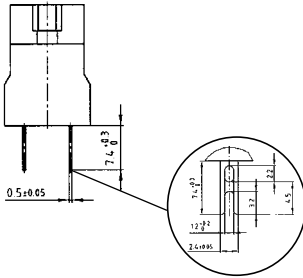

Wire Wrap

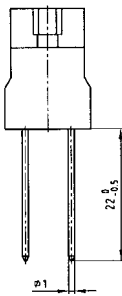

(Dim. = mm)

ORDER DATA

No. of Pos.	Quality class	Solder lug	Wire Wrap
31/32	1	122 C 13019 X	122 C 13069 X

SECTION 8

FLATCABLE CONNECTORS DIN 41651

The CONEC flatcable connector system meets DIN 41651 requirement. It is a reliable and cost effective interconnect system.

The flat cables used with this connector family have 10 to 64 (AWG 28) conductors at 1.27 mm pitch.

The shrouded headers provide convenient guide for the mating socket connectors. The shroud also provides polarization to prevent incorrect mating. The locking ears not only provide latching of the mated pair but also act as ejectors for unmating the mated pair.

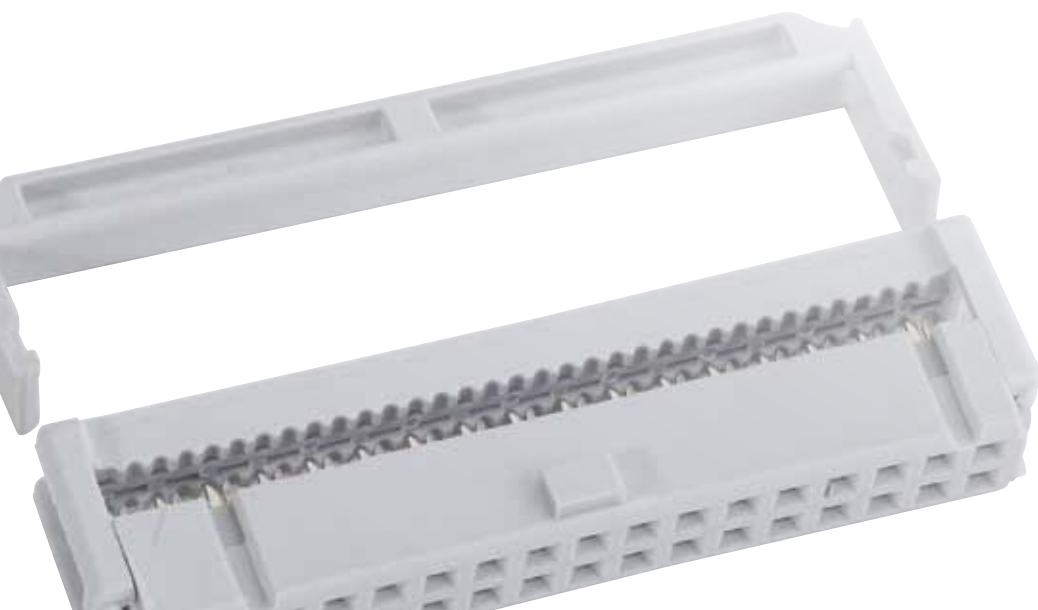



CONEC has beside the DIN41651 Connector serie another flatcable connectors in the program. This are D-Subminiature, Type C (DIN 41612), DIP and PCB Connectors.

Plug and Socket Connectors with 2.54 mm contact spacing complete the program.

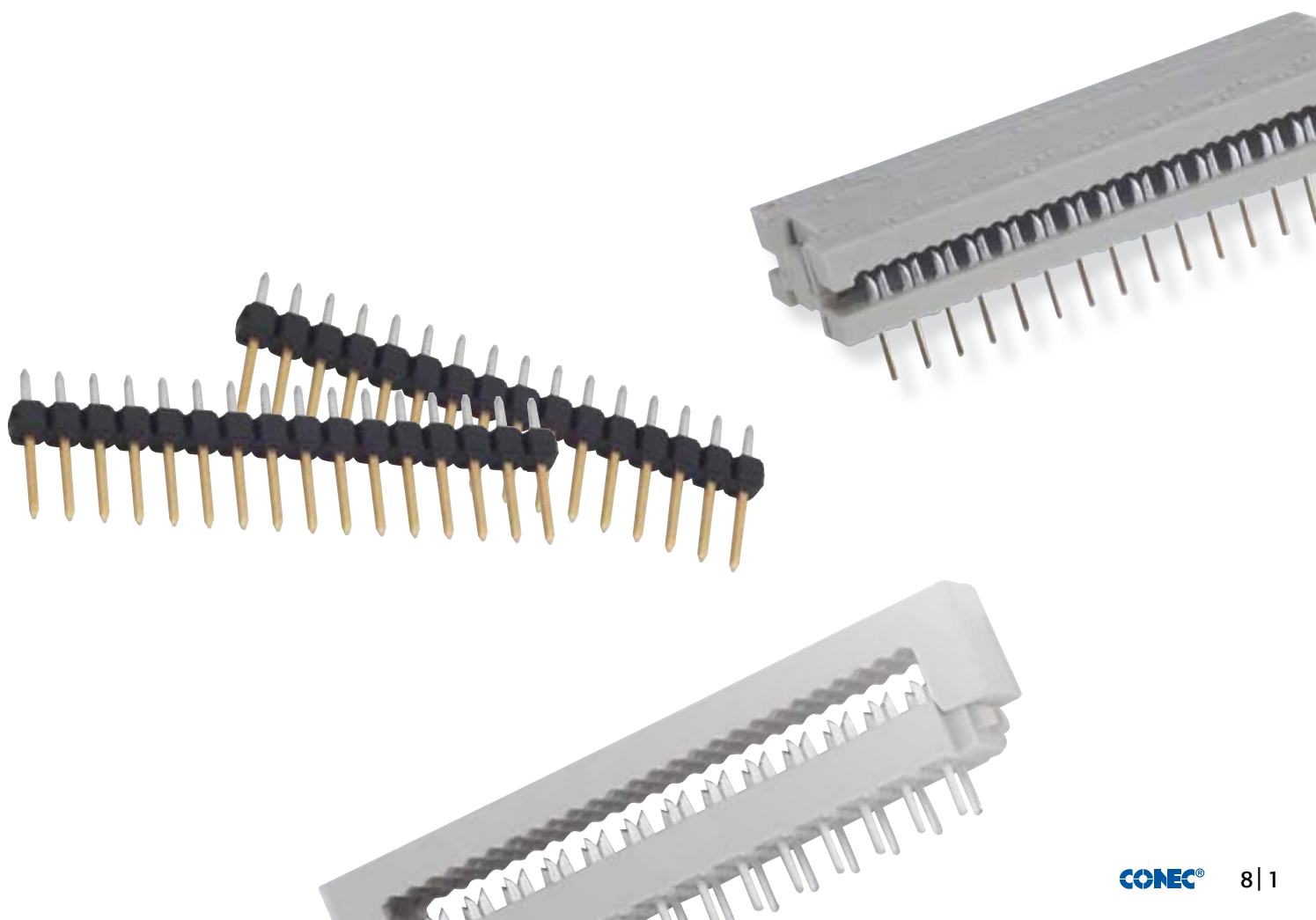

TECHNICAL DATA

Materials	DIN 41651	DIP + PCB	DIN 41612-IDC	CBL	CSU
Insulator		PBT GF		PA	PA
Flammability	UL 94 V-0				
Material contacts	Copper alloy				
Contact plating	gold over nickel	gold over nickel or tin plated	gold over nickel	gold over nickel or tin plated	gold over nickel or tin plated
Working temperature	-65° C to +150° C			-40°C to +135°C	-45°C to +115°C
Working current	1 A			5 A +70° C	
Insulation resistance		$\geq 10^{12} \Omega$		$\geq 10^{12} \Omega$	$\geq 10^{12} \Omega$
Contact resistance				$\leq 10 \text{ m}\Omega$	4 mΩ
Voltage proof	1000 V eff.	550 V eff.			
Working voltage		250 V			250 V
Quality class 3 Quality class 2 Quality class 1	50 cycles 400 cycles 500 cycles				

Technical alterations are subjects to change without notice.

FLATCABLE CONNECTORS

Socket connector – insulation displacement termination (IDC)



RoHS compliant

DESCRIPTION

- Contact spacing 2.54 mm
- 6 to 64 positions
- Strain relief needs to be ordered separately
- With polarization key
- Standard quality class 3
- Other quality classes on request

PRODUCT DRAWING

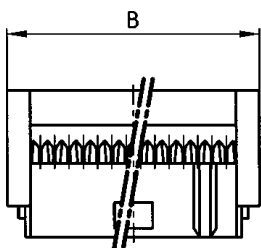
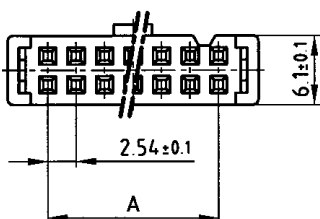

without strain relief

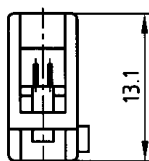

with strain relief (installed)

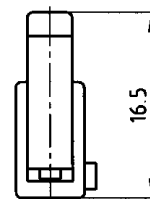

strain relief

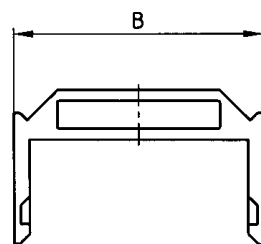

No. of Pos.	A ± 0.1	B ± 0.2	No. of Pos.	A ± 0.1	B ± 0.2
06	2 x 2.54 = 5.08	12.30	26	12 x 2.54 = 30.48	37.60
08	3 x 2.54 = 7.62	14.80	34	16 x 2.54 = 40.64	47.80
10	4 x 2.54 = 10.16	17.30	40	19 x 2.54 = 48.26	55.40
14	6 x 2.54 = 15.24	22.40	50	24 x 2.54 = 60.96	68.10
16	7 x 2.54 = 17.78	24.90	60	29 x 2.54 = 73.66	80.80
20	9 x 2.54 = 22.86	30.00	64	31 x 2.54 = 78.74	85.85

ORDER DATA

(Dim. = mm)

No. of Pos.	Socket connector	Strain relief	No. of Pos.	Socket connector	Strain relief
6	142 A 10199 X		26	142 A 10259 X	140 X 10099 X
8	142 A 10209 X		34	142 A 10269 X	140 X 10109 X
10	142 A 10219 X	140 X 10059 X	40	142 A 10279 X	140 X 10119 X
14	142 A 10229 X	140 X 10069 X	50	142 A 10289 X	140 X 10129 X
16	142 A 10239 X	140 X 10079 X	60	142 A 10299 X	140 X 10139 X
20	142 A 10249 X	140 X 10089 X	64	142 A 10419 X	140 X 10159 X

FLATCABLE CONNECTORS

Plug connector – straight

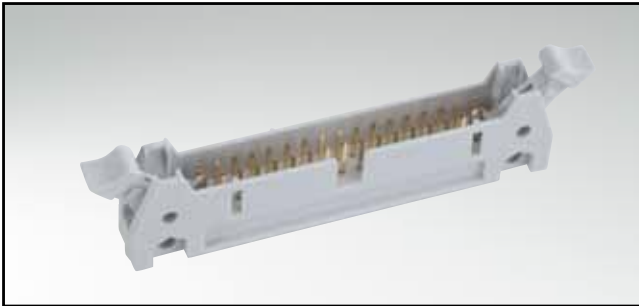

RoHS compliant

DESCRIPTION

- Solder pin
- Pin length 2.9 mm alternative 4.5 mm (*) on request
- 10 to 64 positions
- Center polarization
- Available with long, short and without latches
- Long latches for socket connector with strain relief

PRODUCT DRAWING

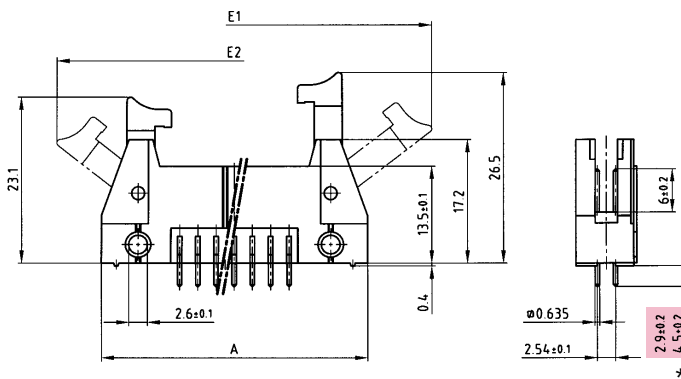

PCB-hole pattern

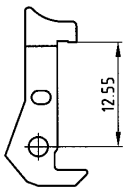
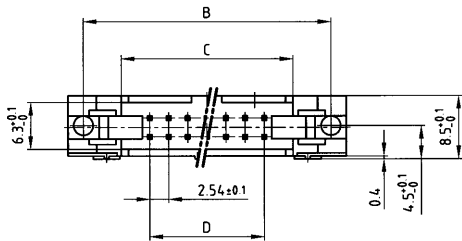
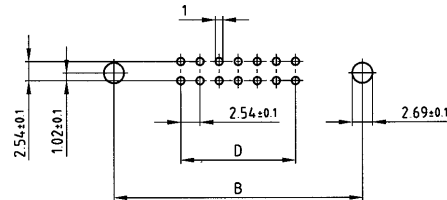

Long latches
Part no. 140 X 10019 X

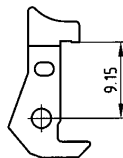

Short latches
Part no. 140 X 10029 X

No. of Pos.	A ±0.2	B ±0.1	C ±0.2	D ±0.1	E1	E2
10	32.00	27.94	17.82	4x2.54=10.16	50.00	44.50
14	37.08	33.02	22.90	6x2.54=15.24	55.00	49.50
16	39.62	35.56	25.44	7x2.54=17.78	57.60	52.10
20	44.70	40.64	30.52	9x2.54=22.86	62.50	57.00
26	52.32	48.26	38.14	12x2.54=30.48	70.10	64.60
34	62.48	58.42	48.30	16x2.54=40.64	80.30	74.80
40	70.10	66.04	55.92	19x2.54=48.26	87.90	82.40
50	82.80	78.74	68.62	24x2.54=60.96	100.70	95.20
60	95.50	91.44	81.32	29x2.54=73.66	113.40	107.90
64	100.58	96.52	86.40	31x2.54=78.74	118.52	113.02

ORDER DATA

(Dim. = mm)

No. of Pos.	WITHOUT LATCHES		WITH SHORT LATCHES		WITH LONG LATCHES	
	Pin length 2.9 mm	Pin length 4.5 mm*	Pin length 2.9 mm	Pin length 4.5 mm*	Pin length 2.9 mm	Pin length 4.5 mm*
10	141 A 10019 X	141 A 10109 X	141 A 10199 X	141 A 10289 X	141 A 10379 X	141 A 10469 X
14	141 A 10029 X	141 A 10119 X	141 A 10209 X	141 A 10299 X	141 A 10389 X	141 A 10479 X
16	141 A 10039 X	141 A 10129 X	141 A 10219 X	141 A 10309 X	141 A 10399 X	141 A 10489 X
20	141 A 10049 X	141 A 10139 X	141 A 10229 X	141 A 10319 X	141 A 10409 X	141 A 10499 X
26	141 A 10059 X	141 A 10149 X	141 A 10239 X	141 A 10329 X	141 A 10419 X	141 A 10509 X
34	141 A 10069 X	141 A 10159 X	141 A 10249 X	141 A 10239 X	141 A 10429 X	141 A 10519 X
40	141 A 10079 X	141 A 10169 X	141 A 10259 X	141 A 10349 X	141 A 10439 X	141 A 10529 X
50	141 A 10089 X	141 A 10179 X	141 A 10269 X	141 A 10359 X	141 A 10449 X	141 A 10539 X
60	141 A 10099 X	141 A 10189 X	141 A 10279 X	141 A 10369 X	141 A 10459 X	141 A 10549 X
64	141 A 12289 X	141 A 12429 X	141 A 12319 X	141 A 12329 X	141 A 12339 X	141 A 12349 X

FLATCABLE CONNECTORS

Plug connector – angled

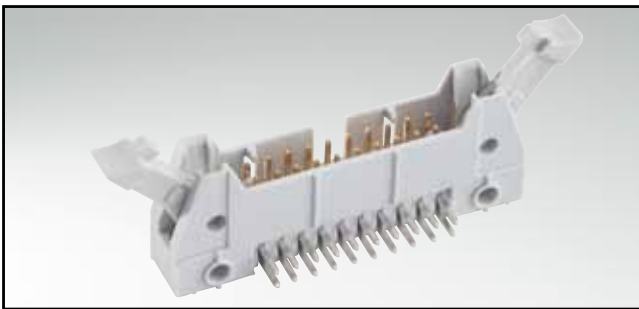

RoHS compliant

DESCRIPTION

- Solder pin
- Pin length 2.9 mm alternative 4.5 mm (*) on request
- 10 to 64 positions
- Center polarization
- Available with long, short and without latches
- Long latches for socket connector with strain relief

PRODUCT DRAWING

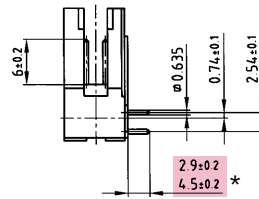
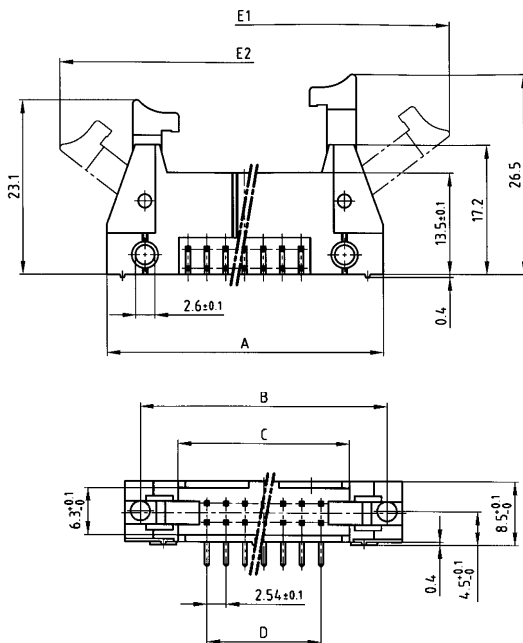

PCB-hole pattern

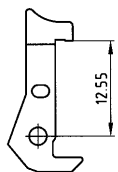
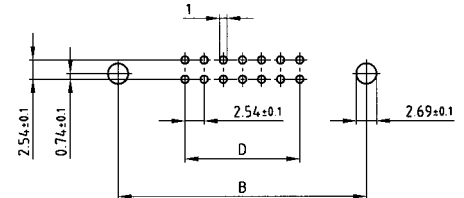

Long latches
Part no. 140 X 10019 X

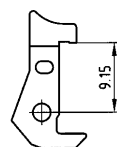

Short latches
Part no. 140 X 10029 X

No. of Pos.	A ±0.2	B ±0.1	C ±0.2	D ±0.1	E1	E2
10	32.00	27.94	17.82	4x2.54=10.16	50.00	44.50
14	37.08	33.02	22.90	6x2.54=15.24	55.00	49.50
16	39.62	35.56	25.44	7x2.54=17.78	57.60	52.10
20	44.70	40.64	30.52	9x2.54=22.86	62.50	57.00
26	52.32	48.26	38.14	12x2.54=30.48	70.10	64.60
34	62.48	58.42	48.30	16x2.54=40.64	80.30	74.80
40	70.10	66.04	55.92	19x2.54=48.26	87.90	82.40
50	82.80	78.74	68.62	24x2.54=60.96	100.70	95.20
60	95.50	91.44	81.32	29x2.54=73.66	113.40	107.90
64	100.58	96.52	86.40	31x2.54=78.74	118.52	113.02

ORDER DATA

(Dim. = mm)

No. of Pos.	WITHOUT LATCHES		WITH SHORT LATCHES		WITH LONG LATCHES	
	Pin length 2.9 mm	Pin length 4.5 mm*	Pin length 2.9 mm	Pin length 4.5 mm*	Pin length 2.9 mm	Pin length 4.5 mm*
10	141 A 10559 X	141 A 10649 X	141 A 10739 X	141 A 10829 X	141 A 10919 X	141 A 11009 X
14	141 A 10569 X	141 A 10659 X	141 A 10749 X	141 A 10839 X	141 A 10929 X	141 A 11019 X
16	141 A 10579 X	141 A 10669 X	141 A 10759 X	141 A 10849 X	141 A 10939 X	141 A 11029 X
20	141 A 10589 X	141 A 10679 X	141 A 10769 X	141 A 10859 X	141 A 10949 X	141 A 11039 X
26	141 A 10599 X	141 A 10689 X	141 A 10779 X	141 A 10869 X	141 A 10959 X	141 A 11049 X
34	141 A 10609 X	141 A 10699 X	141 A 10789 X	141 A 10879 X	141 A 10969 X	141 A 11059 X
40	141 A 10619 X	141 A 10709 X	141 A 10799 X	141 A 10889 X	141 A 10979 X	141 A 11069 X
50	141 A 10629 X	141 A 10719 X	141 A 10809 X	141 A 10899 X	141 A 10989 X	141 A 11079 X
60	141 A 10639 X	141 A 10729 X	141 A 10819 X	141 A 10909 X	141 A 10999 X	141 A 11089 X
64	141 A 12279 X	141 A 12439 X	141 A 12359 X	141 A 12369 X	141 A 12379 X	141 A 12389 X

FLATCABLE CONNECTORS

Low profile header – straight

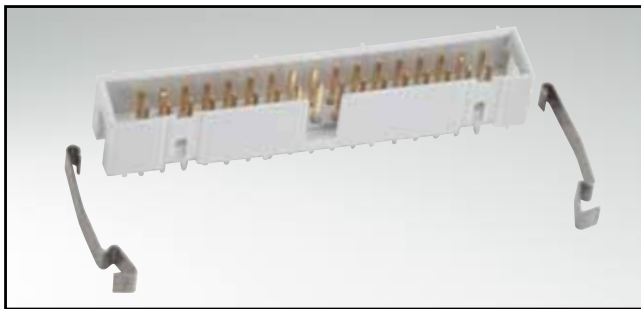

RoHS compliant

DESCRIPTION

- Solder pin
- Pin length 2.9 mm alternative 4.5 mm (*) on request
- 10 to 64 positions
- Center polarization
- Space saving version
- Clip latches need to be ordered separately

PRODUCT DRAWING

PCB-hole pattern

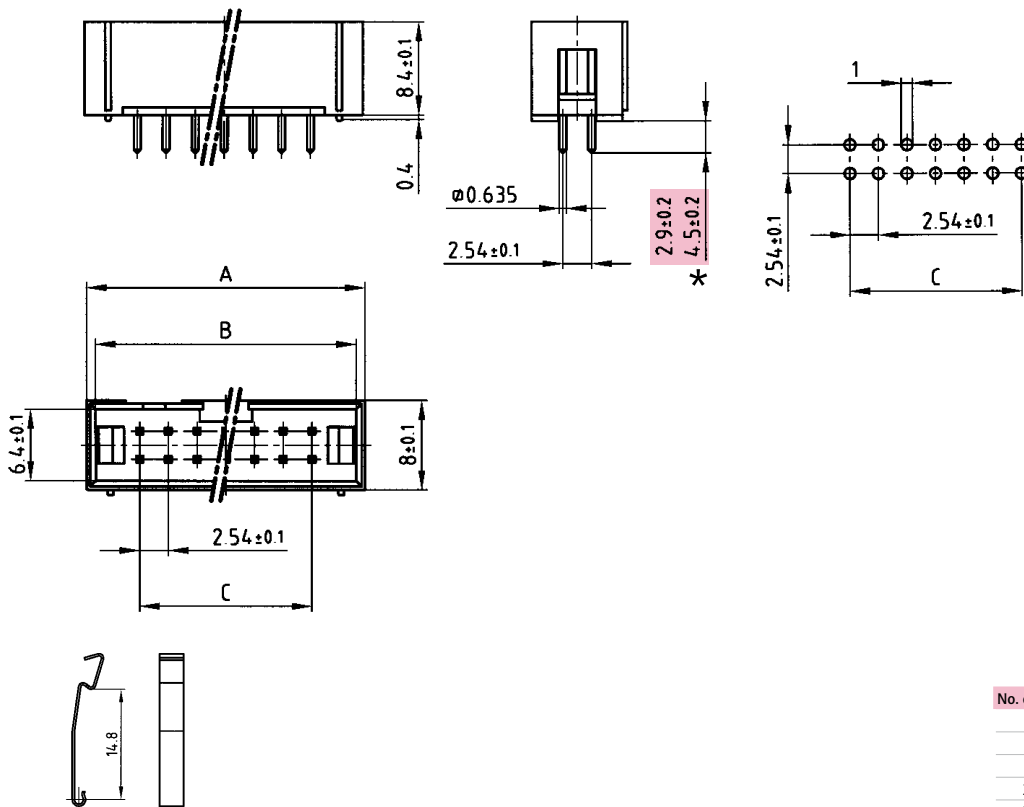

Clip latches
Part no. 140 X 10039 X

No. of Pos.	A ± 0.2	B ± 0.1	C ± 0.1
10	19,50	17,90	4x2.54=10.16
14	24,60	23,00	6x2.54=15.24
16	27,20	25,60	7x2.54=17.78
20	32,30	30,70	9x2.54=22.86
26	39,90	38,30	12x2.54=30.48
34	50,10	48,50	16x2.54=40.64
40	57,80	56,20	19x2.54=48.26
50	70,50	68,90	24x2.54=60.96
64	89,10	86,40	31x2.54=78.74

ORDER DATA

(Dim. = mm)

No. of Pos.	Pin length 2.9 mm	Pin length 4.5 mm*	No. of Pos.	Pin length 2.9 mm	Pin length 4.5 mm*
10	141 A 11639 X	141 A 11729 X	34	141 A 11689 X	141 A 11779 X
14	141 A 11649 X	141 A 11739 X	40	141 A 11699 X	141 A 11789 X
16	141 A 11659 X	141 A 11749 X	50	141 A 11709 X	141 A 11799 X
20	141 A 11669 X	141 A 11759 X	60	141 A 12269 X	141 A 12449 X
26	141 A 11679 X	141 A 11769 X			

FLATCABLE CONNECTORS

Low profile header – angled

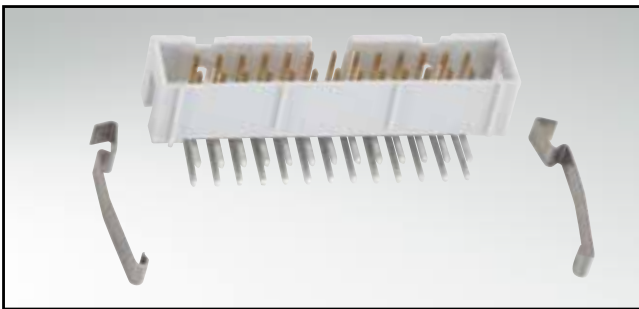

RoHS compliant

DESCRIPTION

- Solder pin
- Pin length 2.9 mm alternative 4.5 mm (*) on request
- 10 to 64 positions
- Center polarization
- Space saving version
- Clip latches need to be ordered separately

PRODUCT DRAWING

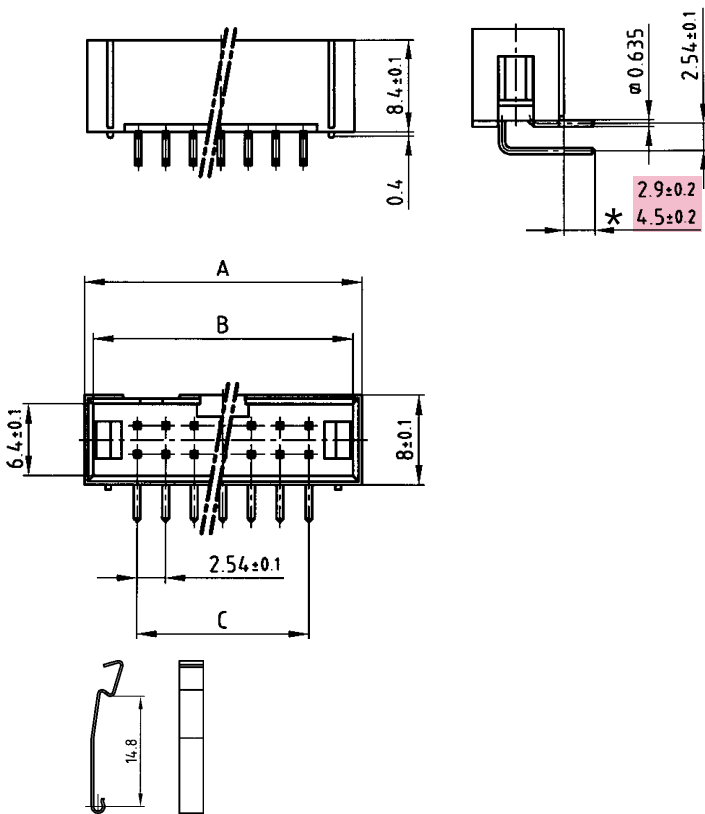

PCB-hole pattern

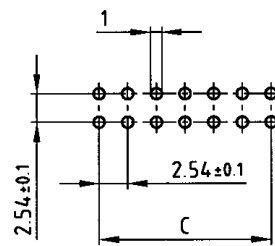

Clip latches
Part no. 140 X 10039 X

No. of Pos.	A ± 0.2	B ± 0.1	C ± 0.1
10	19.50	17.90	4x2.54=10.16
14	24.60	23.00	6x2.54=15.24
16	27.20	25.60	7x2.54=17.78
20	32.30	30.70	9x2.54=22.86
26	39.90	38.30	12x2.54=30.48
34	50.10	48.50	16x2.54=40.64
40	57.80	56.20	19x2.54=48.26
50	70.50	68.90	24x2.54=60.96
64	89.10	86.40	31x2.54=78.74

ORDER DATA

(Dim. = mm)

No. of Pos.	Pin length 2.9 mm	Pin length 4.5 mm*	No. of Pos.	Pin length 2.9 mm	Pin length 4.5 mm*
10	141 A 11909 X	141 A 11999 X	34	141 A 11959 X	141 A 12049 X
14	141 A 11919 X	141 A 12009 X	40	141 A 11969 X	141 A 12059 X
16	141 A 11929 X	141 A 12019 X	50	141 A 11979 X	141 A 12069 X
20	141 A 11939 X	141 A 12029 X	60	141 A 12399 X	141 A 12459 X
26	141 A 11949 X	141 A 12039 X			

FLATCABLE CONNECTORS

Dip connector – 4 to 40 positions

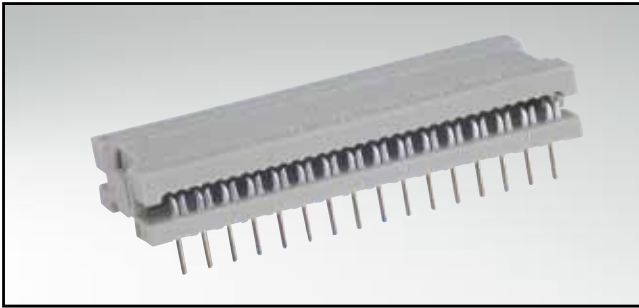

RoHS compliant

DESCRIPTION

- Insulation displacement termination (IDC)
- Contact spacing 2.54 mm
- Contact plating: gold or tin plated

PRODUCT DRAWING

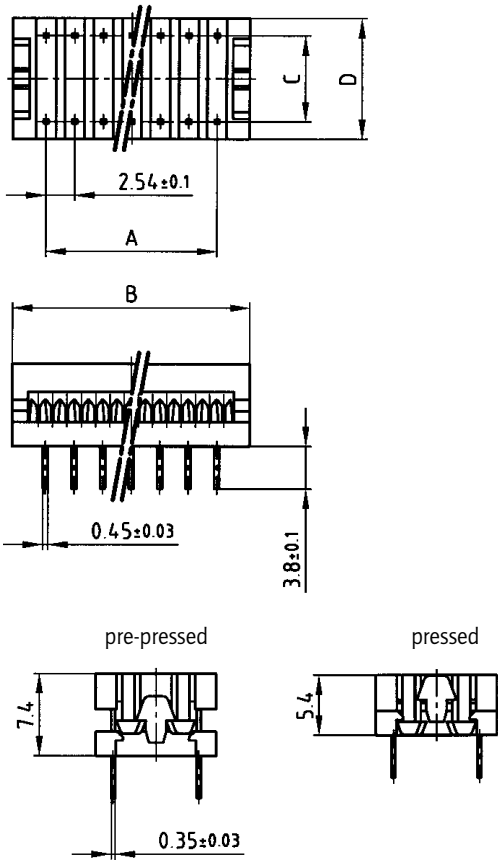

PCB-hole pattern

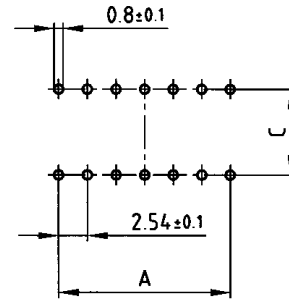

No. of Pos.	A ±0.1	B ±0.2	C ±0.1	D -0.1
4	2.54	8.41	7.62	10.7
6	2x2.54=5.08	10.95	7.62	10.7
8	3x2.54=7.62	13.49	7.62	10.7
10	4x2.54=10.16	16.03	7.62	10.7
12	5x2.54=12.70	18.57	7.62	10.7
14	6x2.54=15.24	21.11	7.62	10.7
16	7x2.54=17.78	23.56	7.62	10.7
18	8x2.54=20.32	26.19	7.62	10.7
20	9x2.54=22.86	28.73	7.62	10.7
22	10x2.54=25.40	31.35	10.16	13.2
24	11x2.54=27.94	33.60	15.24	18.3
28	13x2.54=33.02	38.97	15.24	18.3
32	15x2.54=38.10	44.05	15.24	18.3
36	17x2.54=43.18	49.13	15.24	18.3
40	19x2.54=48.26	53.90	15.24	18.3

ORDER DATA

(Dim. = mm)

No. of Pos.	gold plated	tin plated
4	220 A 10019 X	220 F 10019 X
6	220 A 10029 X	220 F 10029 X
8	220 A 10039 X	220 F 10039 X
10	220 A 10049 X	220 F 10049 X
12	220 A 10059 X	220 F 10059 X
14	220 A 10069 X	220 F 10069 X
16	220 A 10079 X	220 F 10079 X
18	220 A 10089 X	220 F 10089 X

No. of Pos.	gold plated	tin plated
20	220 A 10099 X	220 F 10099 X
22	220 A 10109 X	220 F 10109 X
24	220 A 10119 X	220 F 10119 X
28	220 A 10129 X	220 F 10129 X
32	220 A 10139 X	220 F 10139 X
36	220 A 10149 X	220 F 10149 X
40	220 A 10159 X	220 F 10159 X

FLATCABLE CONNECTORS

PCB connector – 10 to 64 positions

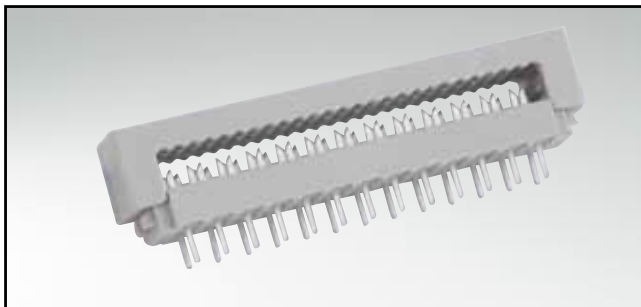

RoHS compliant

DESCRIPTION

- Insulation displacement termination (IDC)
- Contact spacing 2.54 mm
- Contact plating: gold or tin plated

PRODUCT DRAWING

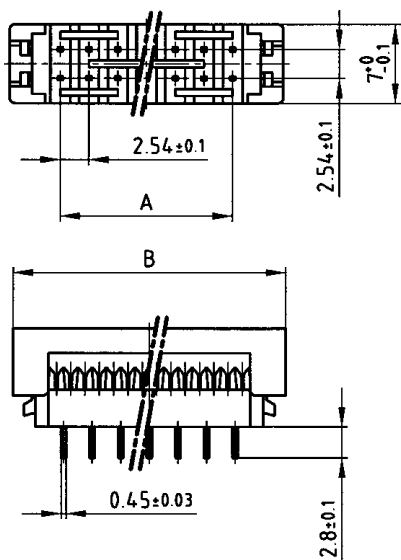

PCB-hole pattern

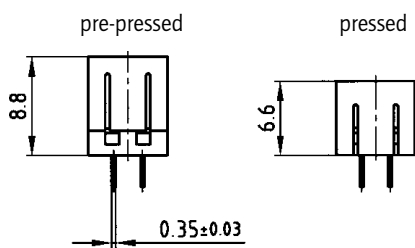
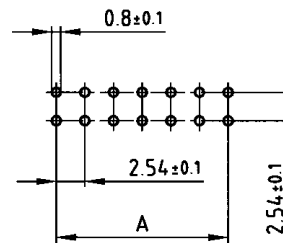

No. of Pos.	A ± 0.1	B ± 0.2
10	4x2.54 = 10.16	19.15
14	6x2.54 = 15.24	24.25
16	7x2.54 = 17.78	26.82
20	9x2.54 = 22.86	31.90
26	12x2.54 = 30.48	39.50
34	16x2.54 = 40.64	49.68
40	19x2.54 = 48.26	57.30
50	24x2.54 = 60.96	70.00
60	29x2.54 = 73.66	82.75
64	31x2.54 = 78.74	87.78

ORDER DATA

(Dim. = mm)

No. of Pos.	tin plated
10	220 F 10169 X
14	220 F 10179 X
16	220 F 10189 X
20	220 F 10199 X
26	220 F 10209 X

No. of Pos.	tin plated
34	220 F 10219 X
40	220 F 10229 X
50	220 F 10239 X
60	220 F 10249 X
64	220 F 10259 X

FLATCABLE CONNECTORS

D-SUB IDC – stamped contacts – 9 to 37 positions



RoHS compliant – CSA listed, File No.: LR 115000-1 – UL listed, File No.: E202784

DESCRIPTION

- For wire size AWG 26 to 28 flatcable
- Mounting style: with through-hole, Ø 3 mm
- Connector includes strain relief
- Quality class 3 (other quality classes on request)
- Shell: steel tin plated

PRODUCT DRAWING

Socket connector

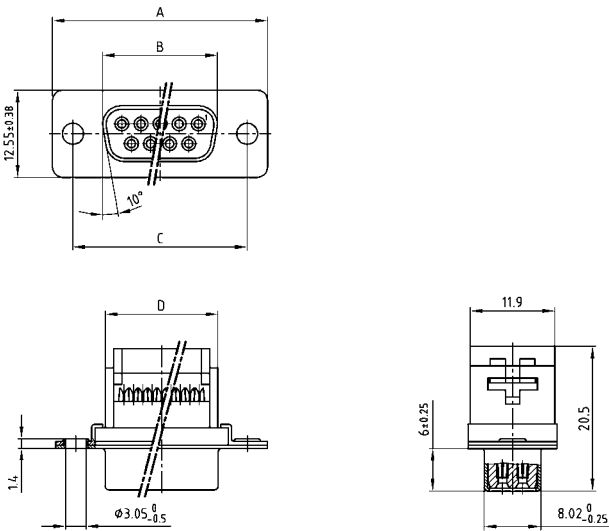

Strain relief

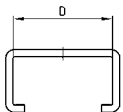

No. of Pos.	A ± 0.25	B ± 0.25	C ± 0.25	D ± 0.25
09	30.80	16.46	25.00	16.10
15	39.10	24.79	33.30	24.00
25	53.09	38.50	47.04	38.14
37	69.40	54.96	63.50	54.60

Plug connector

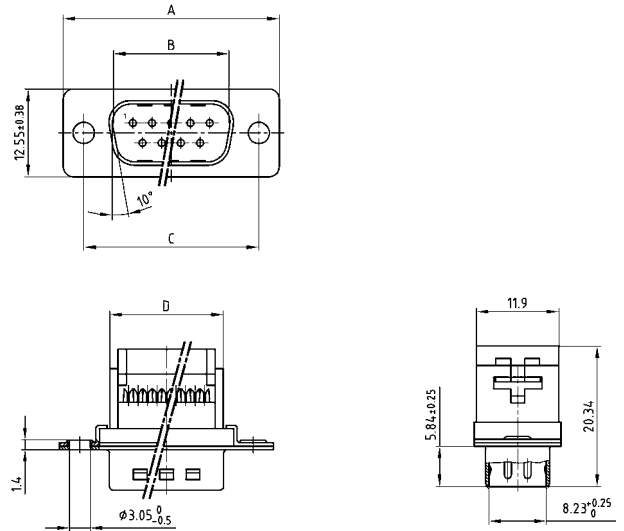

Strain relief

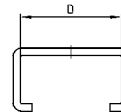

No. of Pos.	A ± 0.25	B ± 0.25	C ± 0.25	D ± 0.25
09	30.80	16.79	25.00	16.10
15	39.10	25.12	33.30	24.00
25	53.09	83.84	47.04	38.14
37	69.40	55.30	63.50	54.60

ORDER DATA

(Dim. = mm)

SOCKET CONNECTOR		
Number of positions	Mounting style	Part number
09	Through-hole	302 A 10089 X
15	Through-hole	302 A 10099 X
25	Through-hole	302 A 10109 X
37	Through-hole	302 A 10119 X

PLUG CONNECTOR		
Number of positions	Mounting style	Part number
09	Through-hole	301 A 10089 X
15	Through-hole	301 A 10099 X
25	Through-hole	301 A 10109 X
37	Through-hole	301 A 10119 X

FLATCABLE CONNECTORS

D-SUB IDC – stamped contacts – 9 to 37 positions



RoHS compliant – CSA listed, File No.: LR 115000-1 – UL listed, File No.: E202784

DESCRIPTION

- For wire size AWG 26 to 28 flatcable
- Mounting style: with 4-40 UNC threaded insert
- Connector includes strain relief
- Quality class 3 (other quality classes on request)
- Shell: steel tin plated
- Not suitable for hood assembly

PRODUCT DRAWING

Socket connector

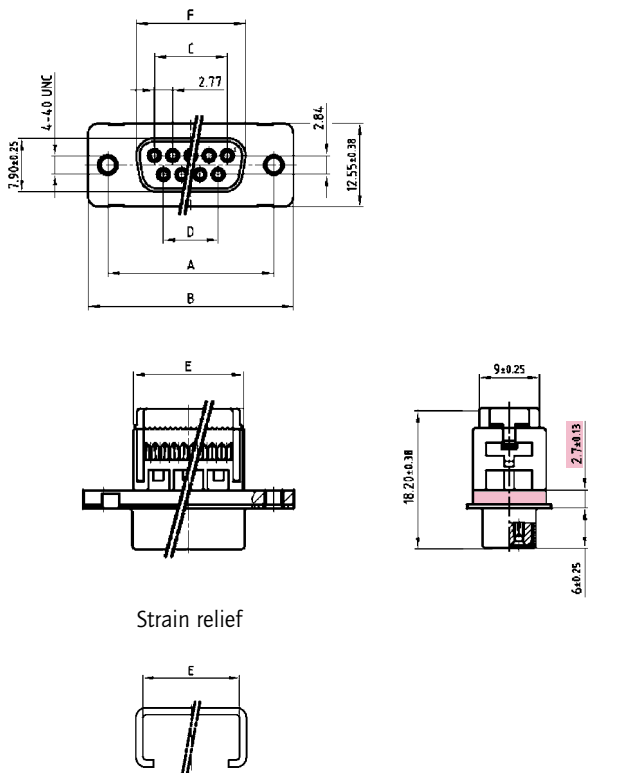

No. of Pos.	A ± 0.13	B ± 0.25	C ± 0.13	D ± 0.13	E ± 0.25	F ± 0.25
09	24.99	30.80	11.08	8.31	16.10	16.33
15	33.32	39.10	19.39	16.62	24.00	24.66
25	47.04	53.09	33.24	30.47	38.14	38.38
37	63.50	69.40	49.86	47.09	54.60	54.84

Plug connector

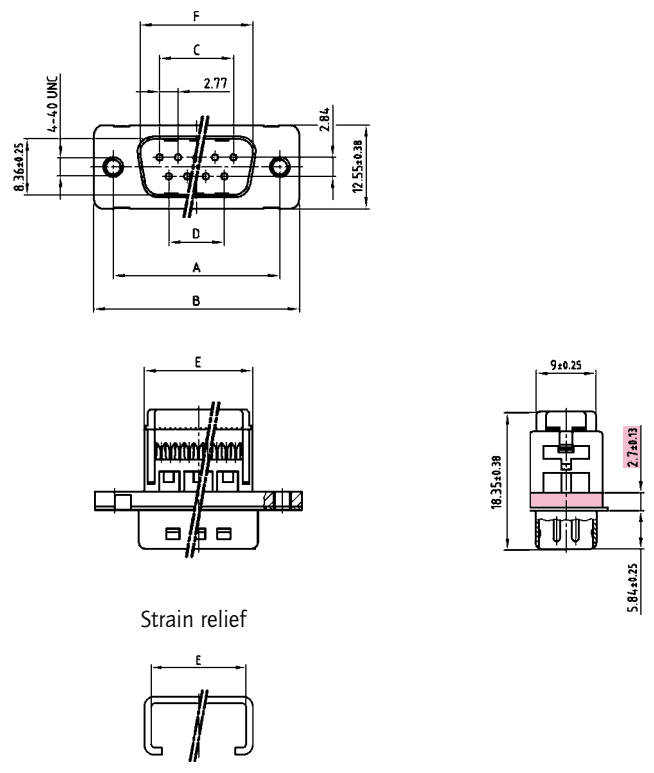

No. of Pos.	A ± 0.13	B ± 0.25	C ± 0.13	D ± 0.13	E ± 0.25	F ± 0.25
09	24.99	30.80	11.08	8.31	16.10	16.92
15	33.32	39.10	19.39	16.62	24.00	25.25
25	47.04	53.09	33.24	30.47	38.14	38.96
37	63.50	69.40	49.86	47.09	54.60	55.45

ORDER DATA

(Dim. = mm)

SOCKET CONNECTOR		
Number of positions	Mounting style	Part number
09	Threaded insert 4-40 UNC	DLS 1XSSAG04 X
15	Threaded insert 4-40 UNC	DLS 2XSSAG04 X
25	Threaded insert 4-40 UNC	DLS 3XSSAG04 X
37	Threaded insert 4-40 UNC	DLS 4XSSAG04 X

PLUG CONNECTOR		
Number of positions	Mounting style	Part number
09	Threaded insert 4-40 UNC	DLS 1XPSAG04 X
15	Threaded insert 4-40 UNC	DLS 2XPSAG04 X
25	Threaded insert 4-40 UNC	DLS 3XPSAG04 X
37	Threaded insert 4-40 UNC	DLS 4XPSAG04 X

FLATCABLE CONNECTORS

D-SUB IDC – stamped contacts – 9 to 37 positions



RoHS compliant – CSA listed, File No.: LR 115000-1 – UL listed, File No.: E202784

DESCRIPTION

- For wire size AWG 26 to 28 flatcable
- Mounting style: with through-hole, Ø 3 mm
- Strain relief need to be ordered separately
- Quality class 3 (also available in quality class 1)
- Shell: Steel tin plated

PRODUCT DRAWING

Socket connector

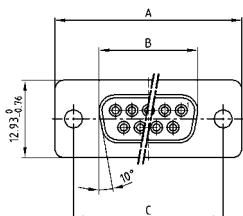

Mounting style: Through-hole

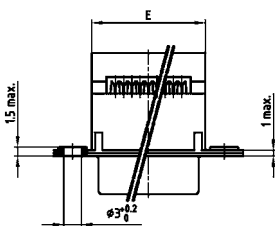

Strain relief

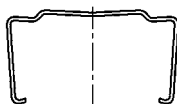

No. of Pos.	A -0.76	B +0.25	C	E +0.10
09	30.80	16.30	25.00 +0.12	18.73
15	39.20	24.60	33.30 +0.15 -0.10	26.86
25	53.10	38.30	47.04 ±0.13	40.78
37	69.40	54.80	63.50 ±0.13	57.04

Plug connector

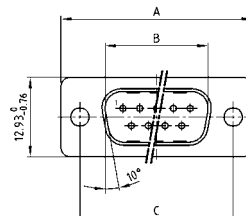

Mounting style: Through-hole

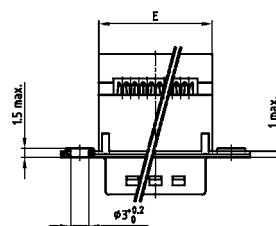

Strain relief

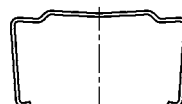

No. of Pos.	A -0.76	B +0.25	C	E +0.10
09	30.80	16.79	25.00 +0.12	18.73
15	39.20	25.12	33.30 +0.15 -0.10	26.86
25	53.10	38.84	47.04 ±0.13	40.78
37	69.40	55.30	63.50 ±0.13	57.04

ORDER DATA

(Dim. = mm)

SOCKET CONNECTOR		
Number of positions	Mounting style	Part number
09	Through-hole	162 A 11899 X
15	Through-hole	162 A 11909 X
25	Through-hole	162 A 11919 X
37	Through-hole	162 A 11929 X
09	Strain relief	160 X 10019 X
15	Strain relief	160 X 10029 X
25	Strain relief	160 X 10039 X
37	Strain relief	160 X 10049 X

PLUG CONNECTOR		
Number of positions	Mounting style	Part number
09	Through-hole	161 A 13499 X
15	Through-hole	161 A 13509 X
25	Through-hole	161 A 13519 X
37	Through-hole	161 A 13529 X
09	Strain relief	160 X 10019 X
15	Strain relief	160 X 10029 X
25	Strain relief	160 X 10039 X
37	Strain relief	160 X 10049 X

FLATCABLE CONNECTORS

D-SUB IDC – stamped contacts – 50 positions

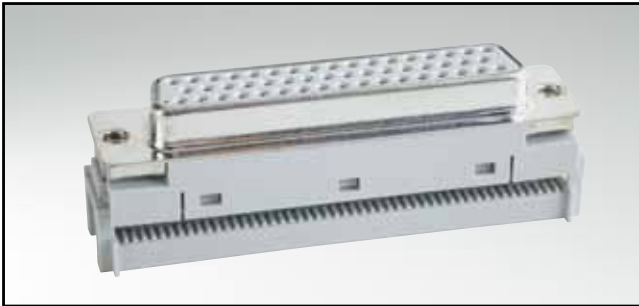

RoHS compliant – CSA listed, File No.: LR 115000-1 – UL listed, File No.: E202784

DESCRIPTION

- For wire size AWG 26 to 28 flatcable
- Mounting style: with 4-40 UNC threaded insert
- Strain relief need to be ordered separately
- Quality class 3 (also available in quality class 1)
- Shell: Steel tin plated

PRODUCT DRAWING

Socket connector

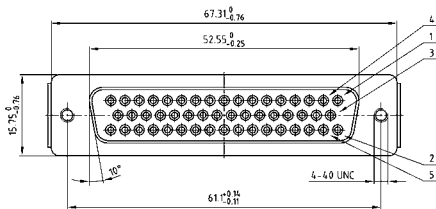

Plug connector

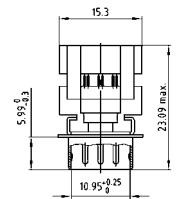
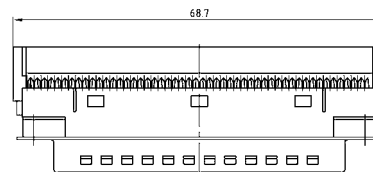
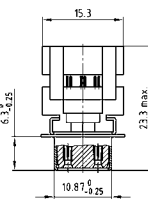
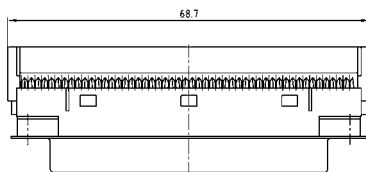
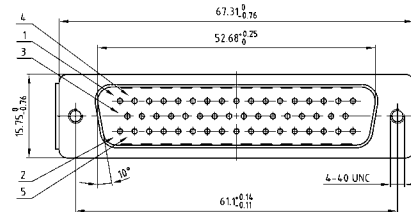

Strain relief



Strain relief



ORDER DATA

(Dim. = mm)

SOCKET CONNECTOR		
Number of positions	Mounting style	Part number
50	Threaded insert 4-40 UNC	162 A 11939 X
50	Strain relief	160 X 10059 X

PLUG CONNECTOR		
Number of positions	Mounting style	Part number
50	Threaded insert 4-40 UNC	161 A 13539 X
50	Strain relief	160 X 10059 X

FLATCABLE CONNECTORS

Type C – female connector – Insulation displacement termination (IDC) – 64 positions

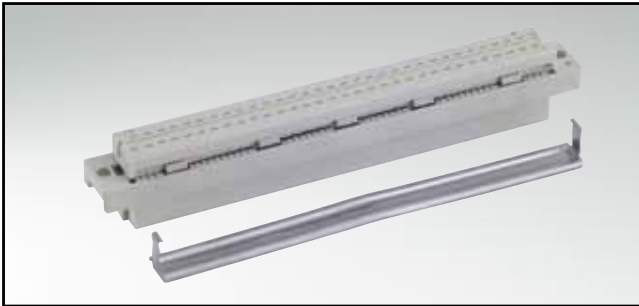

RoHS compliant

DESCRIPTION

- Flat cable termination
- Strain relief need to be ordered separately
- Quality class 3 (also available in quality class 2 or 1)

PRODUCT DRAWING

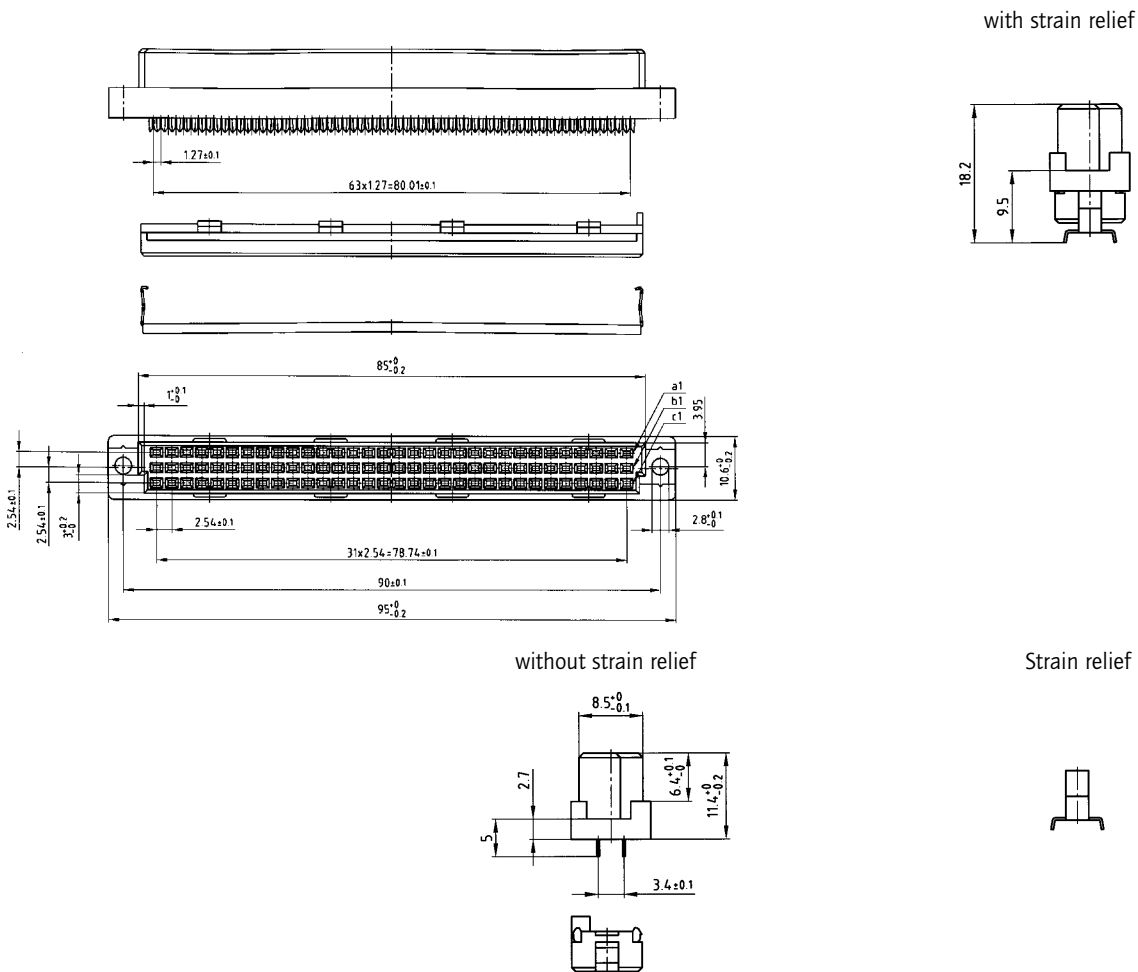

ORDER DATA

(Dim. = mm)

No. of Pos.	• = contact, + = no contact						Female connector without strain relief	Strain relief
	Pos	1	2	3	4	5		
64	a	•	•	•	•	•	122 A 11699 X	120 X 10169 X
	b	+	+	+	+	+		
	c	•	•	•	•	•		

FLATCABLE

Grey or color-coded

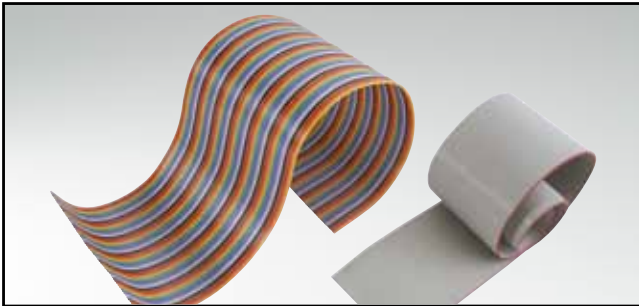

RoHS compliant

DESCRIPTION

Flat cable **colored grey**

- Flame-retardant ref. class UL-VW-1
- UL-Style No. 2651

Flat cable **color-coded**

- Flame-retardant ref. class UL-VW-1
- UL-Style No. 2651

PRODUCT DRAWING

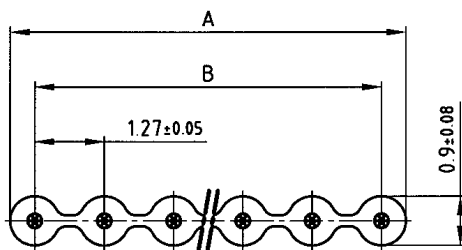

Technical Data	
Conductor:	Cu tin plated
Dielectric strength:	> 2 kV at 50 Hz, at acc. over one minute
Insulation:	min. 100 Ω x km at 20 °C
Conductor resistant:	max. 216 Ω / km at 20 °C
Capacitance:	max. 60 pf / m at 1 kHz
Impedance (GSG):	ca. 100 Ω at 1MHz
Current rating:	max. 2,1 A at 25 °C
Working voltage:	max. 300 V
Temperature range:	at rest: -30 °C to +105 °C (-40 °C per ISO6722) in motion: -20 °C to +105 °C (-40 °C per ISO6722)

No. of Pos.	A	B
10	12.70 ^{+0.25}	11.43 ^{+0.18}
14	17.78 ^{+0.25}	16.51 ^{+0.18}
16	20.32 ^{+0.38}	19.05 ^{+0.28}
20	25.40 ^{+0.38}	24.13 ^{+0.28}
25	31.75 ^{+0.38}	30.48 ^{+0.28}
34	43.18 ^{+0.51}	41.91 ^{+0.38}
40	50.80 ^{+0.51}	49.53 ^{+0.38}
50	63.50 ^{+0.51}	62.23 ^{+0.38}
64	81.28 ^{+0.51}	80.01 ^{+0.38}

Flame-retardant ref. class UL-VW-1 / CSA FT-1

(Dim. = mm)

ORDER DATA

No. of Pos.	Flat cable grey
10	145 X 10029 X
14	145 X 10039 X
16	145 X 10059 X
20	145 X 10069 X
25	145 X 10089 X
34	145 X 10109 X
40	145 X 10129 X
50	145 X 10139 X
64	145 X 10159 X

No. of Pos.	Flat cable color-coded
10	145 X 10179 X
14	145 X 10189 X
16	145 X 10209 X
20	145 X 10219 X
25	145 X 10239 X
34	145 X 10259 X
40	145 X 10279 X
50	145 X 10289 X
64	145 X 10309 X

CSU - PIN HEADER

Straight version – one and two rows

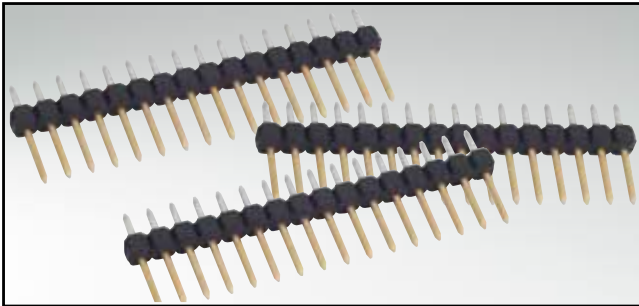

RoHS compliant

DESCRIPTION

- Solder pin
- Contact spacing 2.54 mm
- One row: 5, 10, 20, 30, 40 and 50 positions
- Two row: 10, 20, 40, 60, 80 and 100 positions
- Further positions on request
- Contact plating:
 - gold plated in mating area and tin in solder area
 - completely tin plated
- Other platings on request

PRODUCT DRAWING

One row straight

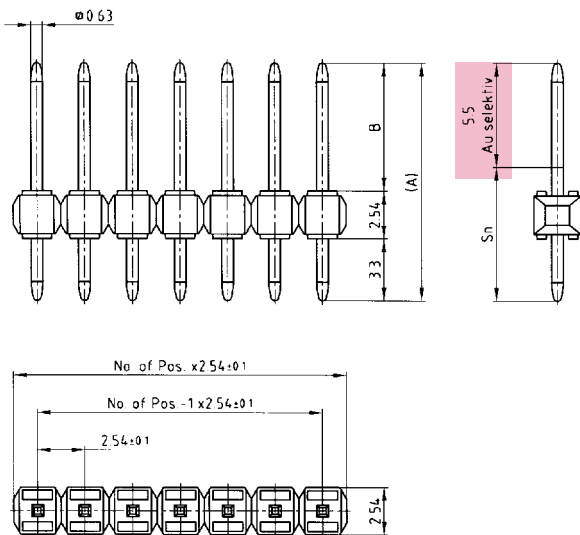

Two row straight

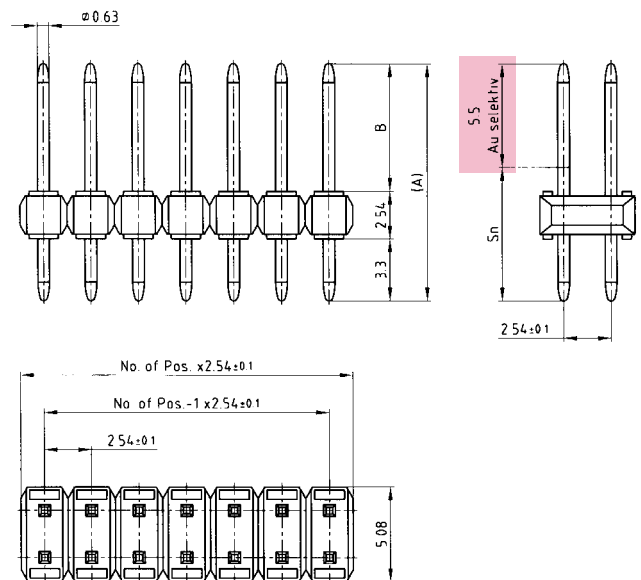

Pin length A	B ^{+0.1}
11,3	5,46
12,6	6,76
14,7	8,66
17,7	11,86
19,8	13,96
21,6	15,76
24,9	19,06

ORDER DATA

(Dim. = mm)

ONE ROW – STRAIGHT – PIN LENGTH 11.3 MM		
Number of positions	gold plated	tin plated
5	201 A 12059 X	201 F 12059 X
10	201 A 12109 X	201 F 12109 X
20	201 A 12209 X	201 F 12209 X
30	201 A 12309 X	201 F 12309 X
40	201 A 22159 X	201 F 22159 X
50	201 A 22259 X	201 F 22259 X

TWO ROW – STRAIGHT – PIN LENGTH 11.3 MM		
Number of positions	gold plated	tin plated
10	201 A 12419 X	201 F 12419 X
20	201 A 12469 X	201 F 12469 X
40	201 A 12569 X	201 F 12569 X
60	201 A 12669 X	201 F 12669 X
80	201 A 22299 X	201 F 22299 X
100	201 A 22399 X	201 F 22399 X

ONE ROW – STRAIGHT – PIN LENGTH 12.6 MM		
Number of positions	gold plated	tin plated
5	201 A 10059 X	201 F 10059 X
10	201 A 10109 X	201 F 10109 X
20	201 A 10209 X	201 F 10209 X
30	201 A 10309 X	201 F 10309 X
40	201 A 22439 X	201 F 22439 X
50	201 A 22539 X	201 F 22539 X

TWO ROW – STRAIGHT – PIN LENGTH 12.6 MM		
Number of positions	gold plated	tin plated
10	201 A 10419 X	201 F 10419 X
20	201 A 10469 X	201 F 10469 X
40	201 A 10569 X	201 F 10569 X
60	201 A 10669 X	201 F 10669 X
80	201 A 22579 X	201 F 22579 X
100	201 A 22679 X	201 F 22679 X

CSU - PIN HEADER

Straight version – one and two rows

ORDER DATA

ONE ROW – STRAIGHT – PIN LENGTH 14.7 MM		
Number of positions	gold plated	tin plated
5	201 A 12779 X	201 F 12779 X
10	201 A 12829 X	201 F 12829 X
20	201 A 12929 X	201 F 12929 X
30	201 A 13029 X	201 F 13029 X
40	201 A 22719 X	201 F 22719 X
50	201 A 22819 X	201 F 22819 X

ONE ROW - STRAIGHT – PIN LENGTH 17.7 MM		
Number of positions	gold plated	tin plated
5	201 A 13499 X	201 F 13499 X
10	201 A 13549 X	201 F 13549 X
20	201 A 13649 X	201 F 13649 X
30	201 A 13749 X	201 F 13749 X
40	201 A 22999 X	201 F 22999 X
50	201 A 23099 X	201 F 23099 X

ONE ROW – STRAIGHT – PIN LENGTH 19.8 MM		
Number of positions	gold plated	tin plated
5	201 A 14219 X	201 F 14219 X
10	201 A 14269 X	201 F 14269 X
20	201 A 14369 X	201 F 14369 X
30	201 A 14469 X	201 F 14469 X
40	201 A 23279 X	201 F 23279 X
50	201 A 23379 X	201 F 23379 X

ONE ROW – STRAIGHT – PIN LENGTH 21.6 MM		
Number of positions	gold plated	tin plated
5	201 A 14939 X	201 F 14939 X
10	201 A 14989 X	201 F 14989 X
20	201 A 15089 X	201 F 15089 X
30	201 A 15189 X	201 F 15189 X
40	201 A 23559 X	201 F 23559 X
50	201 A 23659 X	201 F 23659 X

ONE ROW – STRAIGHT – PIN LENGTH 24.9 MM		
Number of positions	gold plated	tin plated
5	201 A 15659 X	201 F 15659 X
10	201 A 15709 X	201 F 15709 X
20	201 A 15809 X	201 F 15809 X
30	201 A 15909 X	201 F 15909 X
40	201 A 23839 X	201 F 23839 X
50	201 A 23939 X	201 F 23939 X

TWO ROW – STRAIGHT – PIN LENGTH 14.7 MM		
Number of positions	gold plated	tin plated
10	201 A 13139 X	201 F 13139 X
20	201 A 13189 X	201 F 13189 X
40	201 A 13289 X	201 F 13289 X
60	201 A 13389 X	201 F 13389 X
80	201 A 22859 X	201 F 22859 X
100	201 A 22959 X	201 F 22959 X

TWO ROW - STRAIGHT – PIN LENGTH 17.7 MM		
Number of positions	gold plated	tin plated
10	201 A 13859 X	201 F 13859 X
20	201 A 13909 X	201 F 13909 X
40	201 A 14009 X	201 F 14009 X
60	201 A 14109 X	201 F 14109 X
80	201 A 23139 X	201 F 23139 X
100	201 A 23239 X	201 F 23239 X

TWO ROW – STRAIGHT – PIN LENGTH 19.8 MM		
Number of positions	gold plated	tin plated
10	201 A 14579 X	201 F 14579 X
20	201 A 14629 X	201 F 14629 X
40	201 A 14729 X	201 F 14729 X
60	201 A 14829 X	201 F 14829 X
80	201 A 23419 X	201 F 23419 X
100	201 A 23519 X	201 F 23519 X

TWO ROW – STRAIGHT – PIN LENGTH 21.6 MM		
Number of positions	gold plated	tin plated
10	201 A 15299 X	201 F 15299 X
20	201 A 15349 X	201 F 15349 X
40	201 A 15449 X	201 F 15449 X
60	201 A 15549 X	201 F 15549 X
80	201 A 23699 X	201 F 23699 X
100	201 A 23799 X	201 F 23799 X

TWO ROW – STRAIGHT – PIN LENGTH 24.9 MM		
Number of positions	gold plated	tin plated
10	201 A 16019 X	201 F 16019 X
20	201 A 16069 X	201 F 16069 X
40	201 A 16169 X	201 F 16169 X
60	201 A 16269 X	201 F 16269 X
80	201 A 23979 X	201 F 23979 X
100	201 A 24079 X	201 F 24079 X

CSU - PIN HEADER

Angled version – one and two row

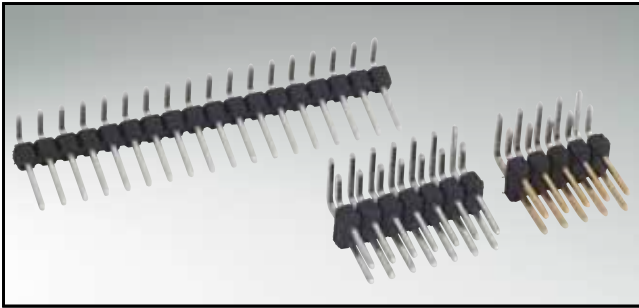

RoHS compliant

DESCRIPTION

- Solder pin
- Contact spacing 2.54 mm
- One row: 5, 10, 20, 30, 40 and 50 positions
- Two row: 10, 20, 40, 60, 80 and 100 positions
- Further positions on request
- Contact plating:
 - gold plated in mating area and tin in solder area
 - completely tin plated
- Other platings on request

PRODUCT DRAWING

One row angled

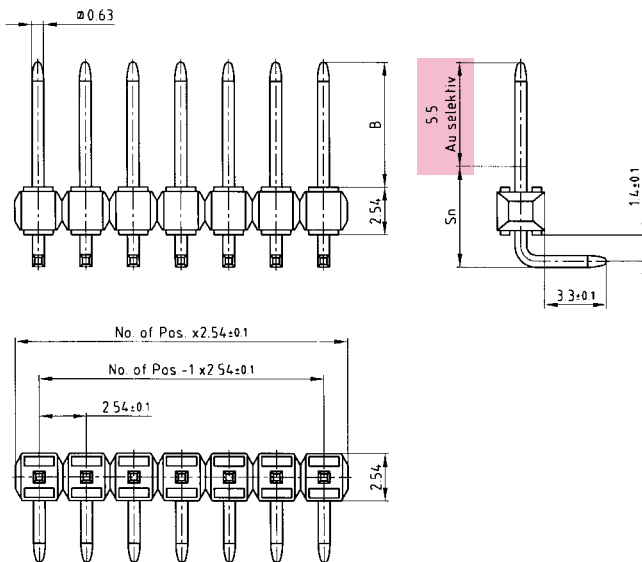

One row angled	
Pin length	B ± 0.1
12.6 mm	04.5
14.7 mm	06.6
17.7 mm	09.6
19.8 mm	11.7
21.6 mm	13.5
24.9 mm	16.8

Two row angled

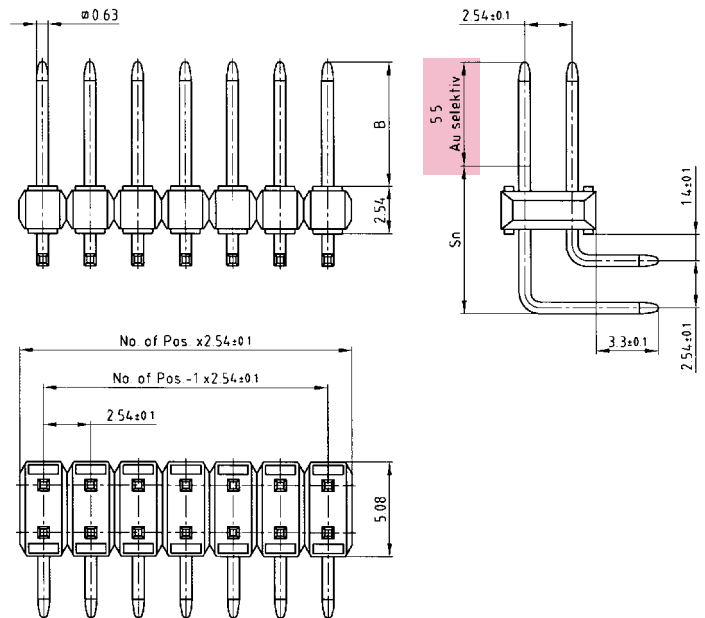

Two row angled		
Pin length inner row	Pin length outer row	B ± 0.1
12.6 mm	17.7 mm	4.5
14.7 mm	19.8 mm	6.6

(Dim. = mm)

CSU - PIN HEADER

Angled version – one and two row

ORDER DATA

ONE ROW – ANGLED – PIN LENGTH 12.6 MM		
Number of positions	gold plated	tin plated
5	201 A 16379 X	201 F 16379 X
10	201 A 16429 X	201 F 16429 X
20	201 A 16529 X	201 F 16529 X
30	201 A 16629 X	201 F 16629 X
40	201 A 24119 X	201 F 24119 X
50	201 A 24219 X	201 F 24219 X

ONE ROW – ANGLED – PIN LENGTH 14.7 MM		
Number of positions	gold plated	tin plated
5	201 A 10779 X	201 F 10779 X
10	201 A 10829 X	201 F 10829 X
20	201 A 10929 X	201 F 10929 X
30	201 A 11029 X	201 F 11029 X
40	201 A 24399 X	201 F 24399 X
50	201 A 24499 X	201 F 24499 X

ONE ROW – ANGLED – PIN LENGTH 17.7 MM		
Number of positions	gold plated	tin plated
5	201 A 17099 X	201 F 17099 X
10	201 A 17149 X	201 F 17149 X
20	201 A 17249 X	201 F 17249 X
30	201 A 17349 X	201 F 17349 X
40	201 A 24679 X	201 F 24679 X
50	201 A 24779 X	201 F 24779 X

ONE ROW – ANGLED – PIN LENGTH 19.8 MM		
Number of positions	gold plated	tin plated
5	201 A 17459 X	201 F 17459 X
10	201 A 17509 X	201 F 17509 X
20	201 A 17609 X	201 F 17609 X
30	201 A 17709 X	201 F 17709 X
40	201 A 24819 X	201 F 24819 X
50	201 A 24919 X	201 F 24919 X

ONE ROW – ANGLED – PIN LENGTH 21.6 MM		
Number of positions	gold plated	tin plated
5	201 A 17819 X	201 F 17819 X
10	201 A 17869 X	201 F 17869 X
20	201 A 17969 X	201 F 17969 X
30	201 A 18069 X	201 F 18069 X
40	201 A 24959 X	201 F 24959 X
50	201 A 25059 X	201 F 25059 X

ONE ROW – ANGLED – PIN LENGTH 24.9 MM		
Number of positions	gold plated	tin plated
5	201 A 18179 X	201 F 18179 X
10	201 A 18229 X	201 F 18229 X
20	201 A 18329 X	201 F 18329 X
30	201 A 18429 X	201 F 18429 X
40	201 A 25099 X	201 F 25099 X
50	201 A 25199 X	201 F 25199 X

TWO ROW – ANGLED – PIN LENGTH 12.6/17.7 MM		
Number of positions	gold plated	tin plated
10	201 A 16739 X	201 F 16739 X
20	201 A 16789 X	201 F 16789 X
40	201 A 16889 X	201 F 16889 X
60	201 A 16989 X	201 F 16989 X
80	201 A 24259 X	201 F 24259 X
100	201 A 24359 X	201 F 24359 X

TWO ROW – ANGLED – PIN LENGTH 14.7/19.8 MM		
Number of positions	gold plated	tin plated
10	201 A 11139 X	201 F 11139 X
20	201 A 11189 X	201 F 11189 X
40	201 A 11289 X	201 F 11289 X
60	201 A 11389 X	201 F 11389 X
80	201 A 24539 X	201 F 24539 X
100	201 A 24639 X	201 F 24639 X

CSU - PIN HEADER

Double hood – straight – one and two row

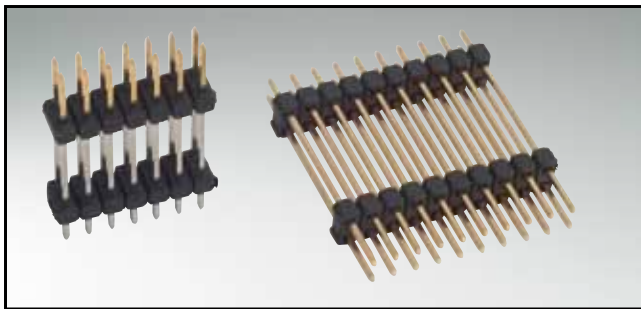

RoHS compliant

DESCRIPTION

- Solder pin
- Contact spacing 2.54 mm
- One row: 5, 10, 20, 30, 40 and 50 positions
- Two row: 10, 20, 40, 60, 80 and 100 positions
- Further positions on request
- Contact plating
 - gold plated in mating area and tin in solder area
 - completely tin plated
- Other platings on request

PRODUCT DRAWING

One row straight

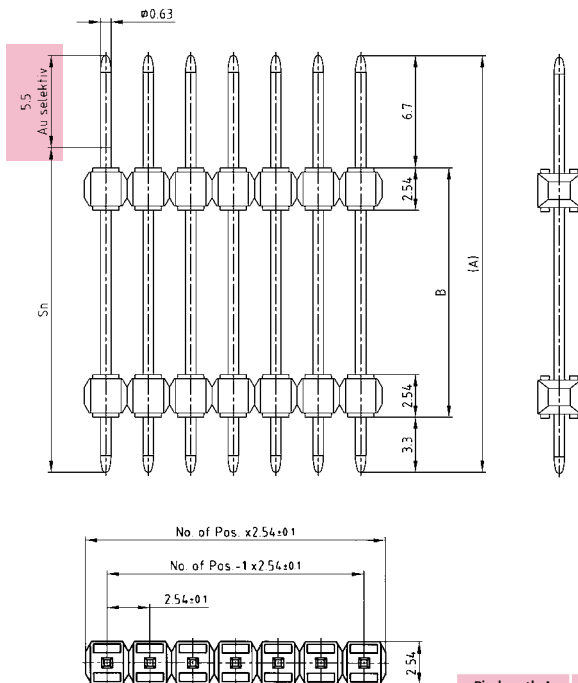

Two row straight

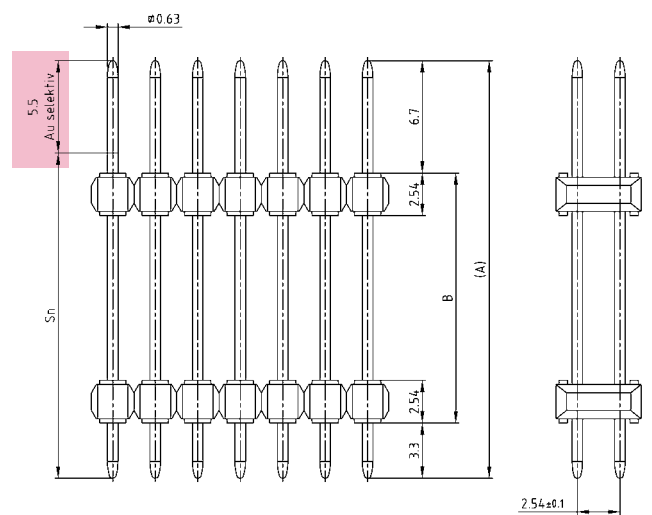

Pin length A	B ^{+0.1}
24.9	14.9
29.0	19.0

ORDER DATA

(Dim. = mm)

ONE ROW – STRAIGHT – PIN LENGTH 24.9 MM		
Number of positions	gold plated	tin plated
5	201 A 18539 X	201 F 18539 X
10	201 A 18589 X	201 F 18589 X
20	201 A 18689 X	201 F 18689 X
30	201 A 18789 X	201 F 18789 X
40	201 A 25239 X	201 F 25239 X
50	201 A 25339 X	201 F 25339 X

TWO ROW – STRAIGHT – PIN LENGTH 24.9 MM		
Number of positions	gold plated	tin plated
10	201 A 18899 X	201 F 18899 X
20	201 A 18949 X	201 F 18949 X
40	201 A 19049 X	201 F 19049 X
60	201 A 19149 X	201 F 19149 X
80	201 A 25379 X	201 F 25379 X
100	201 A 25479 X	201 F 25479 X

ONE ROW – STRAIGHT – PIN LENGTH 29.0 MM		
Number of positions	gold plated	tin plated
5	201 A 19259 X	201 F 19259 X
10	201 A 19309 X	201 F 19309 X
20	201 A 19409 X	201 F 19409 X
30	201 A 19509 X	201 F 19509 X
40	201 A 25519 X	201 F 25519 X
50	201 A 25619 X	201 F 25619 X

TWO ROW – STRAIGHT – PIN LENGTH 29.0 MM		
Number of positions	gold plated	tin plated
10	201 A 19619 X	201 F 19619 X
20	201 A 19669 X	201 F 19669 X
40	201 A 19769 X	201 F 19769 X
60	201 A 19869 X	201 F 19869 X
80	201 A 25659 X	201 F 25659 X
100	201 A 25759 X	201 F 25759 X

SHORT CIRCUIT PLUG

Open and closed version

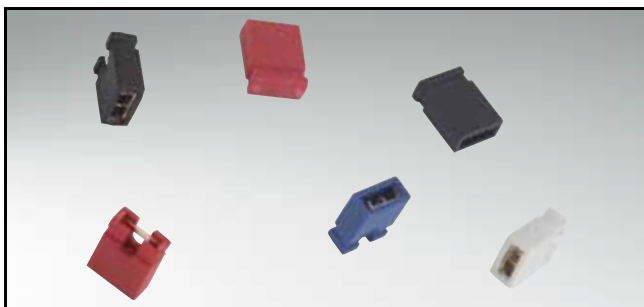

RoHS compliant

DESCRIPTION

- Gold plated contacts
- Contact spacing 2.54 mm
- Several colors

PRODUCT DRAWING

Closed version

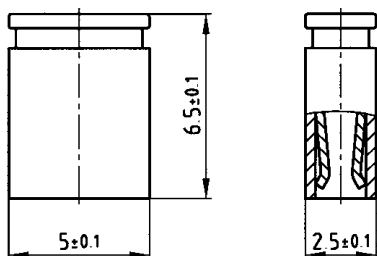

Open version

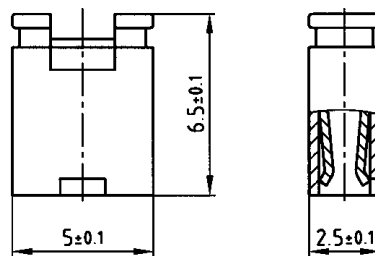

Technical Data

Contacts:	Phosphorbronze
Insulator:	PA 6,6 UL 94 V-0
Contact resistance:	≤ 7 mΩ
Current rating:	2.5 A
Insulation resistance:	10 ¹² Ω
Withdrawal force:	≤ 3 N
Insertion force:	≤ 6 N
Temperature range:	-65°C to +150°C
Contact surface:	Gold over nickel
Contact spacing:	2.54 mm

ORDER DATA

(Dim. = mm)

Color	closed version	Color	open version
grey	200 A 10069 X	grey	200 A 10019 X
black	200 A 10079 X	black	200 A 10029 X
blue	200 A 10089 X	blue	200 A 10039 X
red	200 A 10099 X	red	200 A 10049 X
green	200 A 10109 X	green	200 A 10059 X

CBL - SOCKET CONNECTOR

Straight and angled – one and two row – installation height 5.7 mm

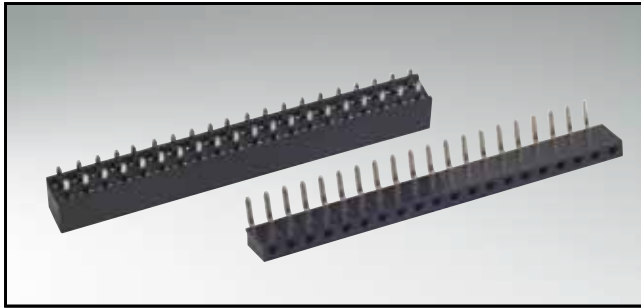

RoHS compliant

DESCRIPTION

- Solder pin
- Contact spacing 2.54 mm
- One row: 5, 10 and 20 positions
- Two row: 10, 20 and 40 positions
- Further positions on request
- Contact plating: gold or tin plated
- Suitable for CSU pin headers

PRODUCT DRAWING

One row straight

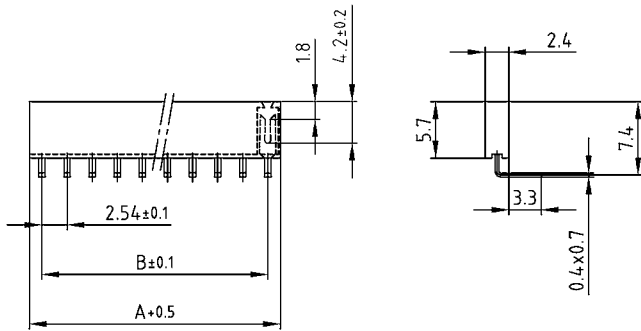

Two row straight

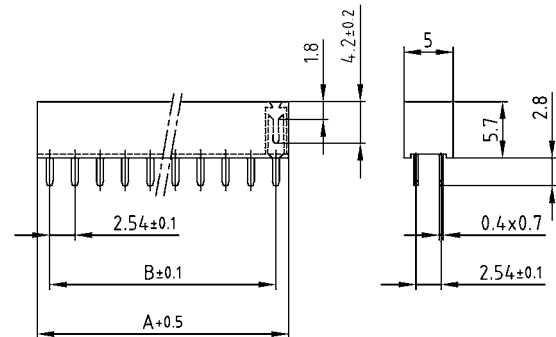

One row angled

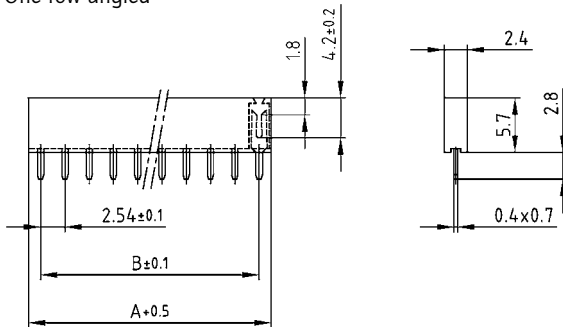

No. of Pos.		A ±0.5	B ±0.1
One row	Two row		
5	10	12.7	4x2.54=10.16
10	20	25.4	9x2.54=22.86
20	40	50.8	19x2.54=48.26

ORDER DATA

(Dim. = mm)

ONE ROW – STRAIGHT		
No. of Pos.	gold plated	tin plated
5	202 A 10019 X	202 F 10019 X
10	202 A 10029 X	202 F 10029 X
20	202 A 10039 X	202 F 10039 X

TWO ROW – STRAIGHT		
No. of Pos.	gold plated	tin plated
10	202 A 10079 X	202 F 10079 X
20	202 A 10089 X	202 F 10089 X
40	202 A 10099 X	202 F 10099 X

ONE ROW – ANGLED		
No. of Pos.	gold plated	tin plated
5	202 A 10049 X	202 F 10049 X
10	202 A 10059 X	202 F 10059 X
20	202 A 10069 X	202 F 10069 X

CBL SOCKET CONNECTOR

Straight – one and two row – installation height 8.5 mm

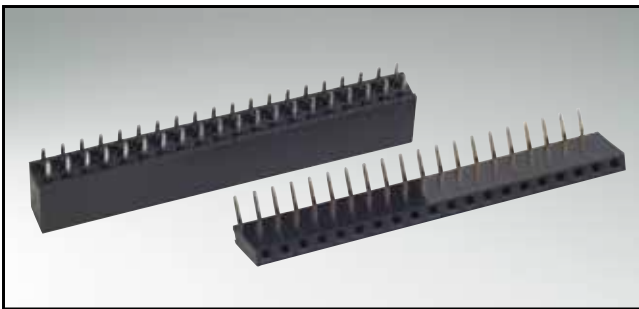

RoHS compliant

DESCRIPTION

- Solder pin
- Contact spacing 2.54 mm
- One row: 5, 10 and 20 positions
- Two row: 10, 20 and 40 positions
- Further positions on request
- Contact plating: gold plated or tin plated
- Suitable for CSU pin headers

PRODUCT DRAWING

One row straight

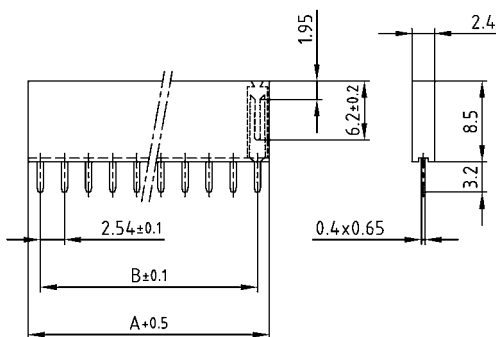

Two row straight

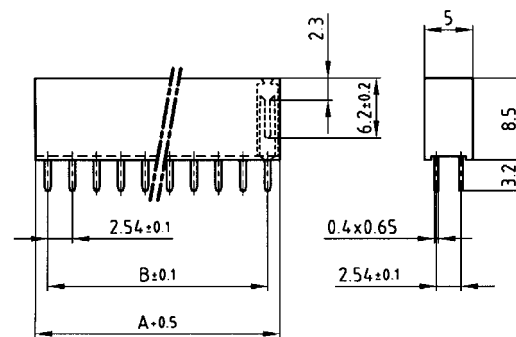

One row angled

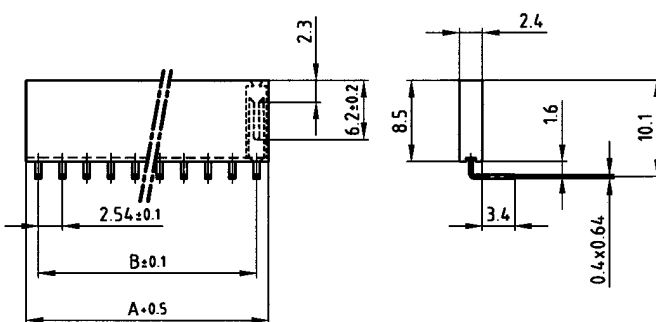

No. of Pos.		A + 0.5	B ± 0.1
one row	two row		
5	10	12.7	4 x 2.54 = 10.16
10	20	25.4	9 x 2.54 = 22.86
20	40	50.8	19 x 2.54 = 48.26

ORDER DATA

(Dim. = mm)

ONE ROW – STRAIGHT		
No. of Pos.	gold plated	tin plated
5	202 A 10109 X	202 F 10109 X
10	202 A 10119 X	202 F 10119 X
20	202 A 10129 X	202 F 10129 X

TWO ROW – STRAIGHT		
No. of Pos.	gold plated	tin plated
10	202 A 10169 X	202 F 10169 X
20	202 A 10179 X	202 F 10179 X
40	202 A 10189 X	202 F 10189 X

ONE ROW – ANGLED		
No. of Pos.	gold plated	tin plated
5	202 A 10139 X	202 F 10139 X
10	202 A 10149 X	202 F 10149 X
20	202 A 10159 X	202 F 10159 X

SECTION 9

INSTALLATION AND ASSEMBLY TOOLS



CONEC offers a variety of special tools to facilitate the reliable, rational assembly of contacts and connectors in its line of flatcable connectors. These tools are practice-proven and ensure the optimal handling of our products.



For technical support and handling technic
please contact the factory.





DESCRIPTION _____

Press in tool
for straight CompactPCI male connector, 38 positions

Part number 360X15129X

Press in tool
for straight CompactPCI male connector, 47 positions

Part number 360X15139X



DESCRIPTION _____

Press in tool
for straight CompactPCI female connector,
38 and 47 positions

Part number 360X15119X

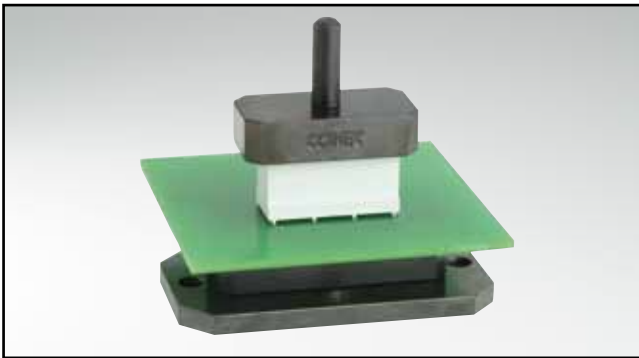

DESCRIPTION _____

Press in tool
for straight AdvancedTCA female connectors

Part number 360X15149X

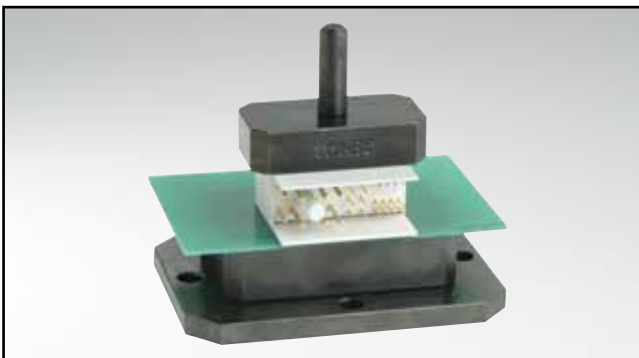

DESCRIPTION _____

Press in tool
for angled AdvancedTCA male connectors

Part number 360X15159X



DESCRIPTION _____

Hand crimp tool
for CompactPCI crimp contacts
(Inserts need to be ordered separately)

Part number 360X21079X



DESCRIPTION _____

Inserts
for above hand crimp tool

Part number 360X21089X

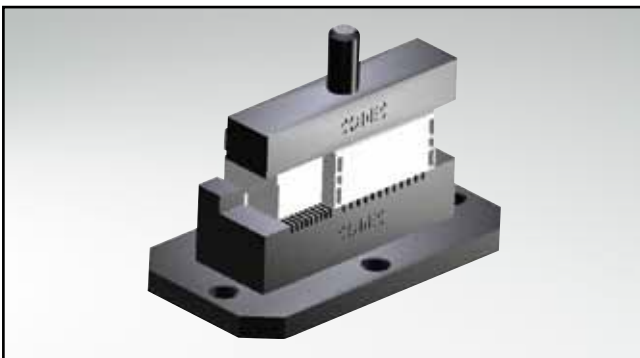

DESCRIPTION _____

Press in tool
for MicroTCA Power Module output connector, angled

Part number 36-000080

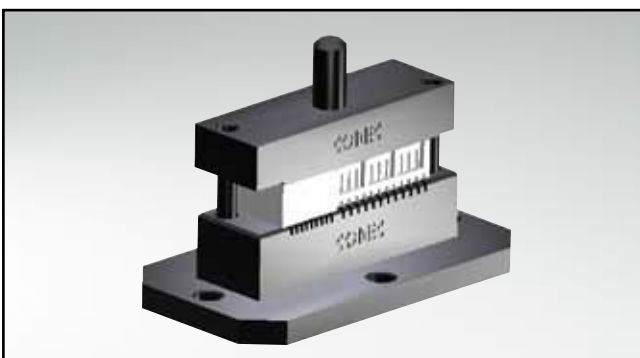

DESCRIPTION _____

Press in tool
for MicroTCA Power Backplane output connector, straight

Part number 36-000070



DESCRIPTION _____

Hand Crimp tool
for high power contacts DIN EN 60603-2

Part number 360 X 10409 X



DESCRIPTION _____

Inserts
for above hand crimp tool

Part number 360 X 20029 X

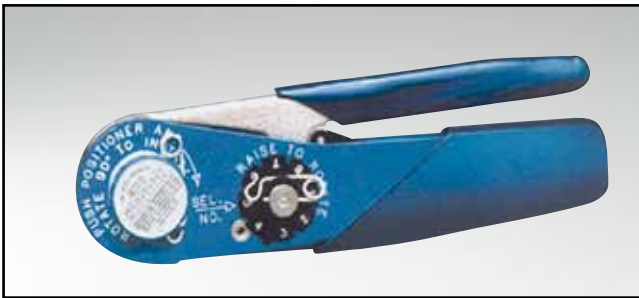

DESCRIPTION _____

Hand Crimp tool
for coaxial contacts (inner conductor) and
D-SUB for Signal Crimp contacts standard and High Density
(Inserts must be ordered separately)

Part number 360 X 10329 X



DESCRIPTION _____

Inserts
for above hand crimp tool

**Inserts for hand crimp tool
for use with hand crimp tool 360X10329X**

Plug Connector	Socket connector	Tool Inserts	Inserts cavity
123 C 21049 X	124 C 21049 X	360 X 11049 X	depends on wire select cavity
123 C 21059 X	124 C 21059 X	360 X 11049 X	
123 C 21069 X	124 C 21069 X	360 X 11049 X	
123 C 23049 X	124 C 23049 X	360 X 11059 X	AWG Cavity
123 C 23059 X	124 C 23059 X	360 X 11059 X	24 → 5
123 C 23069 X	124 C 23069 X	360 X 11059 X	26 → 5
			28 → 4
123 C 33039 X	124 C 33039 X	360 X 11059 X	30 → 3
123 C 33049 X	124 C 33049 X	360 X 11059 X	



DESCRIPTION _____

Hand Crimp tool
for coaxial contacts (outer conductor),
(Inserts must be ordered separately)

Part number 360 X 10519 X

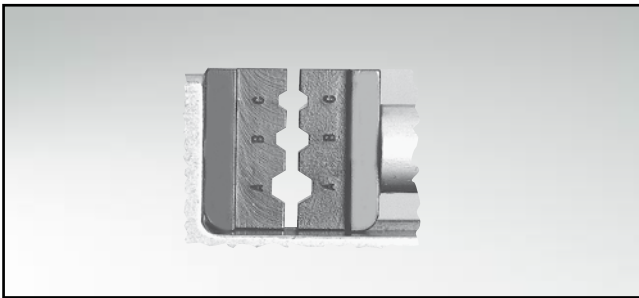

DESCRIPTION _____

Inserts
for above hand crimp tool

**Inserts for hand crimp tool coaxial contacts (outer conductor)
for use with hand crimp tool 360X10519X**

Plug Connector	Socket connector	Tool Inserts	Inserts cavity
123 C 20059 X	124 C 20059 X	360 X 11019 X	C
123 C 20069 X	124 C 20069 X	360 X 11019 X	B
123 C 20079 X	124 C 20079 X	360 X 11039 X	B
123 C 20089 X	124 C 20089 X	360 X 11029 X	A
123 C 21049 X	124 C 21049 X	360 X 11019 X	B
123 C 21059 X	124 C 21059 X	360 X 11029 X	A
123 C 21069 X	124 C 21069 X	360 X 11039 X	B
123 C 22069 X	124 C 22069 X	360 X 11019 X	C
123 C 22079 X	124 C 22079 X	360 X 11019 X	B
123 C 22089 X	124 C 22089 X	360 X 11039 X	B
123 C 22099 X	124 C 22099 X	360 X 11019 X	A
123 C 22109 X	124 C 22109 X	360 X 11029 X	A
123 C 32049 X	124 C 32049 X	360 X 11019 X	C
123 C 32059 X	124 C 32059 X	360 X 11019 X	B
123 C 32069 X	124 C 32069 X	360 X 11019 X	A
123 C 23049 X	124 C 23049 X	360 X 11019 X	B
123 C 23059 X	124 C 23059 X	360 X 11039 X	B
123 C 23069 X	124 C 23069 X	360 X 11029 X	A
123 C 33039 X	124 C 33039 X	360 X 11019 X	B
123 C 33049 X	124 C 33049 X	360 X 11019 X	A



DESCRIPTION _____

Extraction tool
for D-SUB coaxial, high power and high voltage contacts
for DIN EN 60603-2 high power and coaxial contacts

Part number 360 X 10219 X



DESCRIPTION _____

Hand cutting scissors

Part number 360 X 10059 X

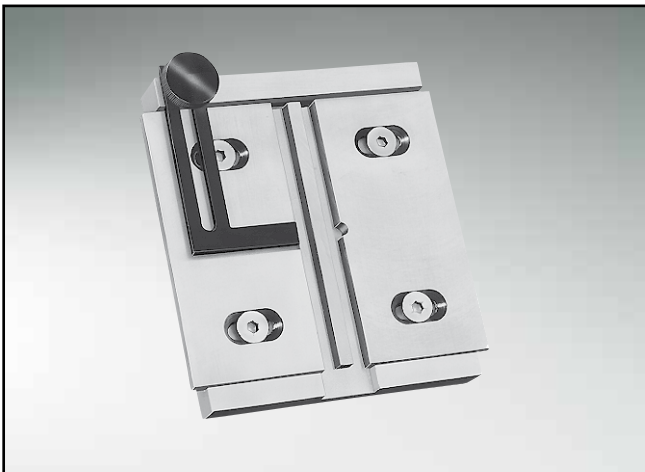

DESCRIPTION _____

Tooling set
for hand lever press (see page 9 | 7)

Part number 360 X 10029 X



DESCRIPTION _____

Manually operated lever press

Part number 360 X 12369 X

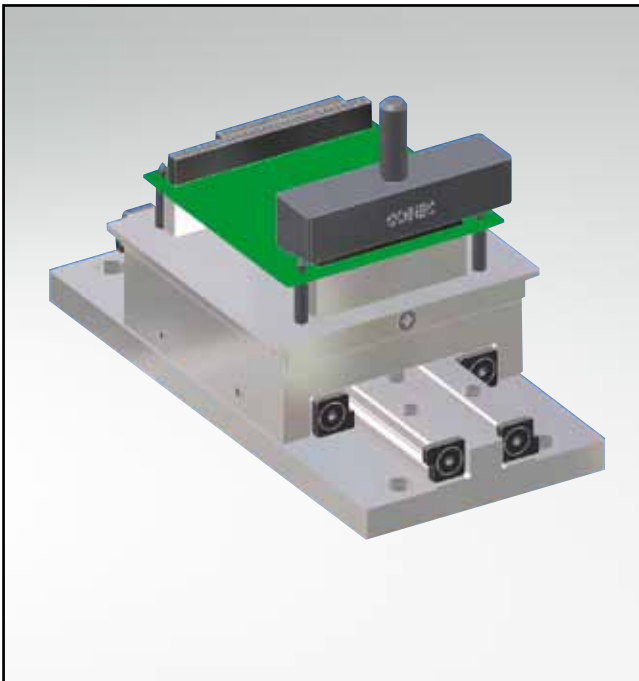

DESCRIPTION _____

Press in tool
for PC104 and PC104plus connectors

Part number 36-000130

SECTION 10

PART NUMBERS



6658

66589



66589B 74

9B 75

66589B 76

B 77

PART NUMBERS

Part Number	Section Page	Part Number	Section Page	Part Number	Section Page
101 A 10019 X	7 4	101 C 10189 X	7 5	102 E 10089 X	7 8
101 A 10029 X	7 4	101 E 10019 X	7 4	102 E 10099 X	7 8
101 A 10039 X	7 4	101 E 10029 X	7 4	120 X 10019 X	4 29
101 A 10049 X	7 5	101 E 10039 X	7 4	120 X 10019 X	4 31
101 A 10059 X	7 5	101 E 10049 X	7 5	120 X 10039 X	4 36
101 A 10069 X	7 5	101 E 10059 X	7 5	120 X 10049 X	4 36
101 A 10079 X	7 6	101 E 10069 X	7 5	120 X 10059 X	4 36
101 A 10089 X	7 6	101 E 10079 X	7 6	120 X 10089 X	4 35
101 A 10099 X	7 6	101 E 10089 X	7 6	120 X 10099 X	4 35
101 A 10109 X	7 6	101 E 10099 X	7 6	120 X 10109 X	4 35
101 A 10119 X	7 6	101 E 10109 X	7 6	120 X 10119 X	4 35
101 A 10129 X	7 6	101 E 10119 X	7 6	120 X 10129 X	4 35
101 A 10139 X	7 3	101 E 10129 X	7 6	120 X 10129 X	4 35
101 A 10149 X	7 3	101 E 10139 X	7 3	120 X 10129 X	4 35
101 A 10159 X	7 3	101 E 10149 X	7 3	120 X 10129 X	4 35
101 A 10169 X	7 5	101 E 10159 X	7 3	120 X 10149 X	4 35
101 A 10179 X	7 5	101 E 10169 X	7 5	120 X 10149 X	4 35
101 A 10189 X	7 5	101 E 10179 X	7 5	120 X 10149 X	4 35
101 B 10019 X	7 4	101 E 10189 X	7 5	120 X 10149 X	4 35
101 B 10029 X	7 4	102 A 10019 X	7 7	120 X 10169 X	4 34
101 B 10039 X	7 4	102 A 10029 X	7 7	120 X 10169 X	8 14
101 B 10049 X	7 5	102 A 10039 X	7 7	120 X 10319 X	4 37
101 B 10059 X	7 5	102 A 10049 X	7 8	120 X 10359 X	4 37
101 B 10069 X	7 5	102 A 10059 X	7 8	120 X 10369 X	4 37
101 B 10079 X	7 6	102 A 10069 X	7 8	120 X 10379 X	4 37
101 B 10089 X	7 6	102 A 10079 X	7 8	121 A 10019 X	4 6
101 B 10099 X	7 6	102 A 10089 X	7 8	121 A 10029 X	4 6
101 B 10109 X	7 6	102 A 10099 X	7 8	121 A 10039 X	4 6
101 B 10119 X	7 6	102 B 10019 X	7 7	121 A 10049 X	4 6
101 B 10129 X	7 6	102 B 10029 X	7 7	121 A 10059 X	4 6
101 B 10139 X	7 3	102 B 10039 X	7 7	121 A 10069 X	4 6
101 B 10149 X	7 3	102 B 10049 X	7 8	121 A 10109 X	4 10
101 B 10159 X	7 3	102 B 10059 X	7 8	121 A 10119 X	4 10
101 B 10169 X	7 5	102 B 10069 X	7 8	121 A 10139 X	4 10
101 B 10179 X	7 5	102 B 10079 X	7 8	121 A 10149 X	4 10
101 B 10189 X	7 5	102 B 10089 X	7 8	121 A 10159 X	4 10
101 C 10019 X	7 4	102 B 10099 X	7 8	121 A 10169 X	4 10
101 C 10029 X	7 4	102 C 10019 X	7 7	121 A 10189 X	4 10
101 C 10039 X	7 4	102 C 10029 X	7 7	121 A 10199 X	4 10
101 C 10049 X	7 5	102 C 10039 X	7 7	121 A 10259 X	4 8
101 C 10059 X	7 5	102 C 10049 X	7 8	121 A 10269 X	4 8
101 C 10069 X	7 5	102 C 10059 X	7 8	121 A 10279 X	4 8
101 C 10079 X	7 6	102 C 10069 X	7 8	121 A 10289 X	4 8
101 C 10089 X	7 6	102 C 10079 X	7 8	121 A 10299 X	4 8
101 C 10099 X	7 6	102 C 10089 X	7 8	121 A 10309 X	4 8
101 C 10109 X	7 6	102 C 10099 X	7 8	121 A 10349 X	4 12
101 C 10119 X	7 6	102 E 10019 X	7 7	121 A 10359 X	4 12
101 C 10129 X	7 6	102 E 10029 X	7 7	121 A 10379 X	4 12
101 C 10139 X	7 3	102 E 10039 X	7 7	121 A 10389 X	4 12
101 C 10149 X	7 3	102 E 10049 X	7 8	121 A 10399 X	4 12
101 C 10159 X	7 3	102 E 10059 X	7 8	121 A 10409 X	4 12
101 C 10169 X	7 5	102 E 10069 X	7 8	121 A 10429 X	4 12
101 C 10179 X	7 5	102 E 10079 X	7 8	121 A 10439 X	4 12

Part Number Section | Page

121 A 10509 X	4 14
121 A 10519 X	4 14
121 A 10529 X	4 14
121 A 10549 X	4 14
121 A 10559 X	4 14
121 A 10569 X	4 14
121 A 10589 X	4 16
121 A 10599 X	4 16
121 A 10619 X	4 16
121 A 10629 X	4 16
121 A 10639 X	4 18
121 A 10649 X	4 18
121 A 10659 X	4 18
121 A 10669 X	4 18
121 A 10699 X	4 23
121 A 10709 X	4 23
121 A 10719 X	4 23
121 A 10789 X	4 26
121 A 10849 X	4 21
121 A 10859 X	4 21
121 A 20779 X	4 21
121 A 20789 X	4 21
121 A 20799 X	4 21
121 A 20809 X	4 21
121 A 20819 X	4 6
121 A 20829 X	4 6
121 A 20839 X	4 6
121 A 20849 X	4 8
121 A 20859 X	4 8
121 A 20869 X	4 8
121 A 20879 X	4 10
121 A 20889 X	4 10
121 A 20909 X	4 10
121 A 20919 X	4 10
121 A 20929 X	4 12
121 A 20939 X	4 12
121 A 20959 X	4 12
121 A 20969 X	4 12
121 A 20979 X	4 18
121 A 20989 X	4 18
121 B 10799 X	4 32
121 E 10949 X	4 30
121 E 10959 X	4 30
121 E 21109 X	4 28
121 E 21119 X	4 28
121 E 21129 X	4 28
122 A 10019 X	4 7
122 A 10029 X	4 7
122 A 10039 X	4 7
122 A 10049 X	4 7
122 A 10059 X	4 7
122 A 10069 X	4 7
122 A 10079 X	4 7

Part Number Section | Page

122 A 10089 X	4 7
122 A 10099 X	4 7
122 A 10109 X	4 7
122 A 10119 X	4 7
122 A 10129 X	4 7
122 A 10139 X	4 7
122 A 10149 X	4 7
122 A 10159 X	4 7
122 A 10169 X	4 11
122 A 10179 X	4 11
122 A 10199 X	4 11
122 A 10209 X	4 11
122 A 10219 X	4 11
122 A 10229 X	4 11
122 A 10249 X	4 11
122 A 10259 X	4 11
122 A 10269 X	4 11
122 A 10279 X	4 11
122 A 10299 X	4 11
122 A 10309 X	4 11
122 A 10319 X	4 11
122 A 10329 X	4 11
122 A 10349 X	4 11
122 A 10359 X	4 11
122 A 10369 X	4 11
122 A 10379 X	4 11
122 A 10399 X	4 11
122 A 10409 X	4 11
122 A 10419 X	4 9
122 A 10429 X	4 9
122 A 10439 X	4 9
122 A 10449 X	4 9
122 A 10459 X	4 9
122 A 10469 X	4 9
122 A 10479 X	4 9
122 A 10489 X	4 9
122 A 10499 X	4 9
122 A 10509 X	4 9
122 A 10519 X	4 9
122 A 10529 X	4 9
122 A 10539 X	4 9
122 A 10559 X	4 9
122 A 10579 X	4 13
122 A 10589 X	4 13
122 A 10609 X	4 13
122 A 10619 X	4 13
122 A 10629 X	4 13
122 A 10639 X	4 13
122 A 10659 X	4 13
122 A 10669 X	4 13
122 A 10679 X	4 13
122 A 10689 X	4 13
122 A 10709 X	4 13

Part Number Section | Page

122 A 10719 X	4 13
122 A 10729 X	4 13
122 A 10739 X	4 13
122 A 10759 X	4 13
122 A 10769 X	4 13
122 A 10779 X	4 13
122 A 10789 X	4 13
122 A 10809 X	4 13
122 A 10819 X	4 13
122 A 10839 X	4 15
122 A 10849 X	4 15
122 A 10859 X	4 15
122 A 10879 X	4 17
122 A 10889 X	4 17
122 A 10919 X	4 19
122 A 10929 X	4 19
122 A 10939 X	4 19
122 A 10949 X	4 19
122 A 10959 X	4 19
122 A 10969 X	4 19
122 A 10979 X	4 24
122 A 10989 X	4 24
122 A 10999 X	4 24
122 A 11039 X	4 24
122 A 11049 X	4 24
122 A 11059 X	4 24
122 A 11069 X	4 24
122 A 11079 X	4 24
122 A 11089 X	4 24
122 A 11099 X	4 24
122 A 11109 X	4 24
122 A 11119 X	4 24
122 A 11129 X	4 27
122 A 11139 X	4 27
122 A 11609 X	4 22
122 A 11619 X	4 22
122 A 11629 X	4 22
122 A 11699 X	4 34
122 A 11699 X	8 14
122 A 13079 X	4 19
122 A 13089 X	4 19
122 A 13099 X	4 22
122 A 13109 X	4 22
122 A 13119 X	4 22
122 A 13129 X	4 22
122 A 13139 X	4 22
122 A 13149 X	4 22
122 A 13159 X	4 22
122 A 13169 X	4 22
122 A 13179 X	4 22
122 A 13189 X	4 7
122 A 13199 X	4 7
122 A 13209 X	4 7

PART NUMBERS

Part Number	Section Page	Part Number	Section Page	Part Number	Section Page
122 A 13219 X	4 9	123 C 11129 X	5 11	123 C 30049 X	5 16
122 A 13229 X	4 9	123 C 11139 X	5 11	123 C 32049 X	5 18
122 A 13239 X	4 9	123 C 11149 X	5 11	123 C 32049 X	9 5
122 A 13249 X	4 11	123 C 12019 X	5 13	123 C 32059 X	5 18
122 A 13259 X	4 11	123 C 12119 X	5 13	123 C 32059 X	9 5
122 A 13279 X	4 11	123 C 13019 X	5 14	123 C 32069 X	5 18
122 A 13289 X	4 11	123 C 13039 X	5 14	123 C 32069 X	9 5
122 A 13299 X	4 13	123 C 13119 X	5 14	123 C 33039 X	5 19
122 A 13309 X	4 13	123 C 13139 X	5 14	123 C 33039 X	9 4
122 A 13329 X	4 13	123 C 14029 X	5 12	123 C 33039 X	9 5
122 A 13339 X	4 13	123 C 14049 X	5 12	123 C 33049 X	5 19
122 A 13349 X	4 19	123 C 14129 X	5 12	123 C 33049 X	9 4
122 A 13359 X	4 19	123 C 14149 X	5 12	123 C 33049 X	9 5
122 B 11159 X	4 33	123 C 20059 X	5 16	123 C 34029 X	5 20
122 B 11739 X	4 25	123 C 20059 X	9 5	123 C 35029 X	5 21
122 B 11749 X	4 25	123 C 20069 X	5 16	124 A 10019 X	5 15
122 B 11759 X	4 25	123 C 20069 X	9 5	124 A 10039 X	5 10
122 C 13019 X	7 9	123 C 20079 X	5 16	124 A 10049 X	5 10
122 C 13069 X	7 9	123 C 20079 X	9 5	124 A 10069 X	5 10
122 E 11609 X	4 29	123 C 20089 X	5 16	124 A 11019 X	5 11
122 E 11619 X	4 29	123 C 20089 X	9 5	124 A 11029 X	5 11
122 E 11629 X	4 29	123 C 21049 X	5 17	124 A 11039 X	5 11
122 E 11639 X	4 29	123 C 21049 X	9 4	124 A 11049 X	5 11
122 E 11649 X	4 29	123 C 21049 X	9 5	124 A 12019 X	5 13
122 E 11659 X	4 29	123 C 21059 X	5 17	124 A 13019 X	5 14
122 E 11709 X	4 31	123 C 21059 X	9 5	124 A 13039 X	5 14
122 E 11719 X	4 31	123 C 21059 X	9 4	124 A 14029 X	5 12
123 A 10019 X	5 15	123 C 21069 X	5 17	124 A 14049 X	5 12
123 A 10039 X	5 10	123 C 21069 X	9 4	124 C 10019 X	5 15
123 A 10049 X	5 10	123 C 21069 X	9 5	124 C 10039 X	5 10
123 A 10069 X	5 10	123 C 22069 X	5 18	124 C 10049 X	5 10
123 A 11019 X	5 11	123 C 22069 X	9 5	124 C 10069 X	5 10
123 A 11029 X	5 11	123 C 22079 X	5 18	124 C 11019 X	5 11
123 A 11039 X	5 11	123 C 22079 X	9 5	124 C 11029 X	5 11
123 A 11049 X	5 11	123 C 22089 X	5 18	124 C 11039 X	5 11
123 A 12019 X	5 13	123 C 22089 X	9 5	124 C 11049 X	5 11
123 A 13019 X	5 14	123 C 22099 X	5 18	124 C 12019 X	5 13
123 A 13039 X	5 14	123 C 22099 X	9 5	124 C 13019 X	5 14
123 A 14029 X	5 12	123 C 22109 X	5 18	124 C 13039 X	5 14
123 A 14049 X	5 12	123 C 22109 X	9 5	124 C 14029 X	5 12
123 C 10019 X	5 15	123 C 23049 X	5 19	124 C 14049 X	5 12
123 C 10029 X	5 15	123 C 23049 X	9 4	124 C 20059 X	5 16
123 C 10039 X	5 10	123 C 23049 X	9 5	124 C 20059 X	9 5
123 C 10049 X	5 10	123 C 23059 X	5 19	124 C 20069 X	5 16
123 C 10069 X	5 10	123 C 23059 X	9 4	124 C 20069 X	9 5
123 C 10139 X	5 10	123 C 23059 X	9 5	124 C 20079 X	5 16
123 C 10149 X	5 10	123 C 23069 X	5 19	124 C 20079 X	9 5
123 C 10169 X	5 10	123 C 23069 X	9 4	124 C 20089 X	5 16
123 C 11019 X	5 11	123 C 23069 X	9 5	124 C 20089 X	9 5
123 C 11029 X	5 11	123 C 24039 X	5 20	124 C 21049 X	5 17
123 C 11039 X	5 11	123 C 24049 X	5 20	124 C 21049 X	9 4
123 C 11049 X	5 11	123 C 25029 X	5 21	124 C 21049 X	9 5
123 C 11119 X	5 11	123 C 30039 X	5 16	124 C 21059 X	5 17

Part Number Section | Page

124 C 21059 X	9 4
124 C 21059 X	9 5
124 C 21069 X	5 17
124 C 21069 X	9 4
124 C 21069 X	9 5
124 C 22069 X	5 18
124 C 22069 X	9 5
124 C 22079 X	5 18
124 C 22079 X	9 5
124 C 22089 X	5 18
124 C 22089 X	9 5
124 C 22099 X	5 18
124 C 22099 X	9 5
124 C 22109 X	5 18
124 C 22109 X	9 5
124 C 23049 X	5 19
124 C 23049 X	9 4
124 C 23049 X	9 5
124 C 23059 X	5 19
124 C 23059 X	9 4
124 C 23059 X	9 5
124 C 23069 X	5 19
124 C 23069 X	9 4
124 C 23069 X	9 5
124 C 24039 X	5 20
124 C 24049 X	5 20
124 C 25029 X	5 21
124 C 30039 X	5 16
124 C 30049 X	5 16
124 C 32049 X	5 18
124 C 32049 X	9 5
124 C 32059 X	5 18
124 C 32059 X	9 5
124 C 32069 X	5 18
124 C 32069 X	9 5
124 C 33039 X	5 19
124 C 33039 X	9 4
124 C 33039 X	9 5
124 C 33049 X	5 19
124 C 33049 X	9 4
124 C 33049 X	9 5
124 C 34029 X	5 20
124 C 35029 X	5 21
12-500590	4 20
12-500600	4 20
13-000011	2 8
13-000021	2 8
13-000051	2 9
13-000061	2 9
13-000131	2 10
13-000141	2 10
13-000151	2 10
13-000161	2 10

Part Number Section | Page

13-000171	2 10
13-000181	2 10
13-000190	2 10
13-000201	2 10
13-000210	2 12
13-000220	2 12
13-000231	2 12
13-000241	2 12
13-000291	2 11
13-000301	2 11
13-000311	2 11
13-000321	2 11
13-000370	2 12
13-000380	2 12
13-000391	2 12
13-000401	2 12
132 C 11019 X	2 11
132 C 11029 X	2 11
132 C 11039 X	2 11
132 C 15019 X	2 11
140 X 10059 X	8 3
140 X 10069 X	8 3
140 X 10079 X	8 3
140 X 10099 X	8 3
140 X 10109 X	8 3
140 X 10119 X	8 3
140 X 10129 X	8 3
140 X 10139 X	8 3
140 X 10159 X	8 3
141 A 10019 X	8 4
141 A 10029 X	8 4
141 A 10039 X	8 4
141 A 10049 X	8 4
141 A 10059 X	8 4
141 A 10069 X	8 4
141 A 10079 X	8 4
141 A 10089 X	8 4
141 A 10099 X	8 4
141 A 10109 X	8 4
141 A 10119 X	8 4
141 A 10129 X	8 4
141 A 10139 X	8 4
141 A 10149 X	8 4
141 A 10159 X	8 4
141 A 10169 X	8 4
141 A 10179 X	8 4
141 A 10189 X	8 4
141 A 10199 X	8 4
141 A 10209 X	8 4
141 A 10219 X	8 4
141 A 10229 X	8 4
141 A 10239 X	8 4
141 A 10239 X	8 4

Part Number Section | Page

141 A 10249 X	8 4
141 A 10259 X	8 4
141 A 10269 X	8 4
141 A 10279 X	8 4
141 A 10289 X	8 4
141 A 10299 X	8 4
141 A 10309 X	8 4
141 A 10319 X	8 4
141 A 10329 X	8 4
141 A 10349 X	8 4
141 A 10359 X	8 4
141 A 10369 X	8 4
141 A 10379 X	8 4
141 A 10389 X	8 4
141 A 10399 X	8 4
141 A 10409 X	8 4
141 A 10419 X	8 4
141 A 10429 X	8 4
141 A 10439 X	8 4
141 A 10449 X	8 4
141 A 10459 X	8 4
141 A 10469 X	8 4
141 A 10479 X	8 4
141 A 10489 X	8 4
141 A 10499 X	8 4
141 A 10509 X	8 4
141 A 10519 X	8 4
141 A 10529 X	8 4
141 A 10539 X	8 4
141 A 10549 X	8 4
141 A 10559 X	8 5
141 A 10569 X	8 5
141 A 10579 X	8 5
141 A 10589 X	8 5
141 A 10599 X	8 5
141 A 10609 X	8 5
141 A 10619 X	8 5
141 A 10629 X	8 5
141 A 10639 X	8 5
141 A 10649 X	8 5
141 A 10659 X	8 5
141 A 10669 X	8 5
141 A 10679 X	8 5
141 A 10689 X	8 5
141 A 10699 X	8 5
141 A 10709 X	8 5
141 A 10719 X	8 5
141 A 10729 X	8 5
141 A 10739 X	8 5
141 A 10749 X	8 5
141 A 10759 X	8 5
141 A 10769 X	8 5
141 A 10779 X	8 5

PART NUMBERS

Part Number	Section Page	Part Number	Section Page	Part Number	Section Page
141 A 10789 X	8 5	141 A 11969 X	8 7	145 X 10279 X	8 15
141 A 10799 X	8 5	141 A 11979 X	8 7	145 X 10289 X	8 15
141 A 10809 X	8 5	141 A 11999 X	8 7	145 X 10309 X	8 15
141 A 10819 X	8 5	141 A 12009 X	8 7	160 X 10019 X	8 12
141 A 10829 X	8 5	141 A 12019 X	8 7	160 X 10019 X	8 12
141 A 10839 X	8 5	141 A 12029 X	8 7	160 X 10029 X	8 12
141 A 10849 X	8 5	141 A 12039 X	8 7	160 X 10029 X	8 12
141 A 10859 X	8 5	141 A 12049 X	8 7	160 X 10039 X	8 12
141 A 10869 X	8 5	141 A 12059 X	8 7	160 X 10039 X	8 12
141 A 10879 X	8 5	141 A 12069 X	8 7	160 X 10049 X	8 12
141 A 10889 X	8 5	141 A 12269 X	8 6	160 X 10049 X	8 12
141 A 10899 X	8 5	141 A 12279 X	8 5	160 X 10059 X	8 13
141 A 10909 X	8 5	141 A 12289 X	8 4	160 X 10059 X	8 13
141 A 10919 X	8 5	141 A 12319 X	8 4	16-000010	2 13
141 A 10929 X	8 5	141 A 12329 X	8 4	161 A 13499 X	8 12
141 A 10939 X	8 5	141 A 12339 X	8 4	161 A 13509 X	8 12
141 A 10949 X	8 5	141 A 12349 X	8 4	161 A 13519 X	8 12
141 A 10959 X	8 5	141 A 12359 X	8 5	161 A 13529 X	8 12
141 A 10969 X	8 5	141 A 12369 X	8 5	161 A 13539 X	8 13
141 A 10979 X	8 5	141 A 12379 X	8 5	162 A 11899 X	8 12
141 A 10989 X	8 5	141 A 12389 X	8 5	162 A 11909 X	8 12
141 A 10999 X	8 5	141 A 12399 X	8 7	162 A 11919 X	8 12
141 A 11009 X	8 5	141 A 12429 X	8 4	162 A 11929 X	8 12
141 A 11019 X	8 5	141 A 12439 X	8 5	162 A 11939 X	8 13
141 A 11029 X	8 5	141 A 12449 X	8 6	162 C 18709 X	2 11
141 A 11039 X	8 5	141 A 12459 X	8 7	200 A 10019 X	8 21
141 A 11049 X	8 5	142 A 10199 X	8 3	200 A 10029 X	8 21
141 A 11059 X	8 5	142 A 10209 X	8 3	200 A 10039 X	8 21
141 A 11069 X	8 5	142 A 10219 X	8 3	200 A 10049 X	8 21
141 A 11079 X	8 5	142 A 10229 X	8 3	200 A 10059 X	8 21
141 A 11089 X	8 5	142 A 10239 X	8 3	200 A 10069 X	8 21
141 A 11639 X	8 6	142 A 10249 X	8 3	200 A 10079 X	8 21
141 A 11649 X	8 6	142 A 10259 X	8 3	200 A 10089 X	8 21
141 A 11659 X	8 6	142 A 10269 X	8 3	200 A 10099 X	8 21
141 A 11669 X	8 6	142 A 10279 X	8 3	200 A 10109 X	8 21
141 A 11679 X	8 6	142 A 10289 X	8 3	201 A 10059 X	8 16
141 A 11689 X	8 6	142 A 10299 X	8 3	201 A 10109 X	8 16
141 A 11699 X	8 6	142 A 10419 X	8 3	201 A 10209 X	8 16
141 A 11709 X	8 6	145 X 10029 X	8 15	201 A 10309 X	8 16
141 A 11729 X	8 6	145 X 10039 X	8 15	201 A 10419 X	8 16
141 A 11739 X	8 6	145 X 10059 X	8 15	201 A 10469 x	8 16
141 A 11749 X	8 6	145 X 10069 X	8 15	201 A 10569 X	8 16
141 A 11759 X	8 6	145 X 10089 X	8 15	201 A 10669 X	8 16
141 A 11769 X	8 6	145 X 10109 X	8 15	201 A 10779 X	8 19
141 A 11779 X	8 6	145 X 10129 X	8 15	201 A 10829 X	8 19
141 A 11789 X	8 6	145 X 10139 X	8 15	201 A 10929 X	8 19
141 A 11799 X	8 6	145 X 10159 X	8 15	201 A 11029 X	8 19
141 A 11909 X	8 7	145 X 10179 X	8 15	201 A 11139 X	8 19
141 A 11919 X	8 7	145 X 10189 X	8 15	201 A 11189 X	8 19
141 A 11929 X	8 7	145 X 10209 X	8 15	201 A 11289 X	8 19
141 A 11939 X	8 7	145 X 10219 X	8 15	201 A 11389 X	8 19
141 A 11949 X	8 7	145 X 10239 X	8 15	201 A 12059 X	8 16
141 A 11959 X	8 7	145 X 10259 X	8 15	201 A 12109 X	8 16

Part Number Section | Page

201 A 12209 X	8 16
201 A 12309 X	8 16
201 A 12419 X	8 16
201 A 12469 X	8 16
201 A 12569 X	8 16
201 A 12669 X	8 16
201 A 12779 X	8 17
201 A 12829 X	8 17
201 A 12929 X	8 17
201 A 13029 X	8 17
201 A 13139 X	8 17
201 A 13189 X	8 17
201 A 13289 X	8 17
201 A 13389 X	8 17
201 A 13499 X	8 17
201 A 13549 X	8 17
201 A 13649 X	8 17
201 A 13749 X	8 17
201 A 13859 X	8 17
201 A 13909 X	8 17
201 A 14009 X	8 17
201 A 14109 X	8 17
201 A 14219 X	8 17
201 A 14269 X	8 17
201 A 14369 X	8 17
201 A 14469 X	8 17
201 A 14579 X	8 17
201 A 14629 X	8 17
201 A 14729 X	8 17
201 A 14829 X	8 17
201 A 14939 X	8 17
201 A 14989 X	8 17
201 A 15089 X	8 17
201 A 15189 X	8 17
201 A 15299 X	8 17
201 A 15349 X	8 17
201 A 15449 X	8 17
201 A 15549 X	8 17
201 A 15659 X	8 17
201 A 15709 X	8 17
201 A 15809 X	8 17
201 A 15909 X	8 17
201 A 16019 X	8 17
201 A 16069 X	8 17
201 A 16169 X	8 17
201 A 16269 X	8 17
201 A 16379 X	8 19
201 A 16429 X	8 19
201 A 16529 X	8 19
201 A 16629 X	8 19
201 A 16739 X	8 19
201 A 16789 X	8 19
201 A 16889 X	8 19

Part Number Section | Page

201 A 16989 X	8 19
201 A 17099 X	8 19
201 A 17149 X	8 19
201 A 17249 X	8 19
201 A 17349 X	8 19
201 A 17459 X	8 19
201 A 17509 X	8 19
201 A 17609 X	8 19
201 A 17709 X	8 19
201 A 17819 X	8 19
201 A 17869 X	8 19
201 A 17969 X	8 19
201 A 18069 X	8 19
201 A 18179 X	8 19
201 A 18229 X	8 19
201 A 18329 X	8 19
201 A 18429 X	8 19
201 A 18539 X	8 20
201 A 18589 X	8 20
201 A 18689 X	8 20
201 A 18789 X	8 20
201 A 18899 X	8 20
201 A 18949 X	8 20
201 A 19049 X	8 20
201 A 19149 X	8 20
201 A 19259 X	8 20
201 A 19309 X	8 20
201 A 19409 X	8 20
201 A 19509 X	8 20
201 A 19619 X	8 20
201 A 19669 X	8 20
201 A 19769 X	8 20
201 A 19869 X	8 20
201 A 22159 X	8 16
201 A 22259 X	8 16
201 A 22299 X	8 16
201 A 22399 X	8 16
201 A 22439 X	8 16
201 A 22539 X	8 16
201 A 22579 X	8 16
201 A 22679 X	8 16
201 A 22719 X	8 17
201 A 22819 X	8 17
201 A 22859 X	8 17
201 A 22959 X	8 17
201 A 22999 X	8 17
201 A 23099 X	8 17
201 A 23139 X	8 17
201 A 23239 X	8 17
201 A 23279 X	8 17
201 A 23379 X	8 17
201 A 23419 X	8 17
201 A 23519 X	8 17

Part Number Section | Page

201 A 23559 X	8 17
201 A 23659 X	8 17
201 A 23699 X	8 17
201 A 23799 X	8 17
201 A 23839 X	8 17
201 A 23979 X	8 17
201 A 24079 X	8 17
201 A 24119 X	8 19
201 A 24219 X	8 19
201 A 24259 X	8 19
201 A 24359 X	8 19
201 A 24399 X	8 19
201 A 24499 X	8 19
201 A 24539 X	8 19
201 A 24639 X	8 19
201 A 24679 X	8 19
201 A 24779 X	8 19
201 A 24819 X	8 19
201 A 24919 X	8 19
201 A 24959 X	8 19
201 A 25059 X	8 19
201 A 25099 X	8 19
201 A 25199 X	8 19
201 A 25239 X	8 20
201 A 25339 X	8 20
201 A 25379 X	8 20
201 A 25479 X	8 20
201 A 25519 X	8 20
201 A 25619 X	8 20
201 A 25659 X	8 20
201 A 25759 X	8 20
201 F 10059 X	8 16
201 F 10109 X	8 16
201 F 10209 X	8 16
201 F 10309 X	8 16
201 F 10419 X	8 16
201 F 10469 X	8 16
201 F 10569 X	8 16
201 F 10669 X	8 16
201 F 10779 X	8 19
201 F 10829 X	8 19
201 F 10929 X	8 19
201 F 11029 X	8 19
201 F 11139 X	8 19
201 F 11189 X	8 19
201 F 11289 X	8 19
201 F 11389 X	8 19
201 F 12059 X	8 16
201 F 12109 X	8 16
201 F 12209 X	8 16
201 F 12309 X	8 16
201 F 12419 X	8 16
201 F 12469 X	8 16

PART NUMBERS

Part Number	Section Page	Part Number	Section Page	Part Number	Section Page
201 F 12569 X	8 16	201 F 17349 X	8 19	201 F 23839 X	8 17
201 F 12669 X	8 16	201 F 17459 X	8 19	201 F 23979 X	8 17
201 F 12779 X	8 17	201 F 17509 X	8 19	201 F 24079 X	8 17
201 F 12829 X	8 17	201 F 17609 X	8 19	201 F 24119 X	8 19
201 F 12929 X	8 17	201 F 17709 X	8 19	201 F 24219 X	8 19
201 F 13029 X	8 17	201 F 17819 X	8 19	201 F 24259 X	8 19
201 F 13139 X	8 17	201 F 17869 X	8 19	201 F 24359 X	8 19
201 F 13189 X	8 17	201 F 17969 X	8 19	201 F 24399 X	8 19
201 F 13289 X	8 17	201 F 18069 X	8 19	201 F 24499 X	8 19
201 F 13389 X	8 17	201 F 18179 X	8 19	201 F 24539 X	8 19
201 F 13499 X	8 17	201 F 18229 X	8 19	201 F 24639 X	8 19
201 F 13549 X	8 17	201 F 18329 X	8 19	201 F 24679 X	8 19
201 F 13649 X	8 17	201 F 18429 X	8 19	201 F 24779 X	8 19
201 F 13749 X	8 17	201 F 18539 X	8 20	201 F 24819 X	8 19
201 F 13859 X	8 17	201 F 18589 X	8 20	201 F 24919 X	8 19
201 F 13909 X	8 17	201 F 18689 X	8 20	201 F 24959 X	8 19
201 F 14009 X	8 17	201 F 18789 X	8 20	201 F 25059 X	8 19
201 F 14109 X	8 17	201 F 18899 X	8 20	201 F 25099 X	8 19
201 F 14219 X	8 17	201 F 18949 X	8 20	201 F 25199 X	8 19
201 F 14269 X	8 17	201 F 19049 X	8 20	201 F 25239 X	8 20
201 F 14369 X	8 17	201 F 19149 X	8 20	201 F 25339 X	8 20
201 F 14469 X	8 17	201 F 19259 X	8 20	201 F 25379 X	8 20
201 F 14579 X	8 17	201 F 19309 X	8 20	201 F 25479 X	8 20
201 F 14629 X	8 17	201 F 19409 X	8 20	201 F 25519 X	8 20
201 F 14729 X	8 17	201 F 19509 X	8 20	201 F 25619 X	8 20
201 F 14829 X	8 17	201 F 19619 X	8 20	201 F 25659 X	8 20
201 F 14939 X	8 17	201 F 19669 X	8 20	201 F 25759 X	8 20
201 F 14989 X	8 17	201 F 19769 X	8 20	202 A 10019 X	8 22
201 F 15089 X	8 17	201 F 19869 X	8 20	202 A 10029 X	8 22
201 F 15189 X	8 17	201 F 22159 X	8 16	202 A 10039 X	8 22
201 F 15299 X	8 17	201 F 22259 X	8 16	202 A 10049 X	8 22
201 F 15349 X	8 17	201 F 22299 X	8 16	202 A 10059 X	8 22
201 F 15449 X	8 17	201 F 22399 X	8 16	202 A 10069 X	8 22
201 F 15549 X	8 17	201 F 22439 X	8 16	202 A 10079 X	8 22
201 F 15659 X	8 17	201 F 22539 X	8 16	202 A 10089 X	8 22
201 F 15709 X	8 17	201 F 22579 X	8 16	202 A 10099 X	8 22
201 F 15809 X	8 17	201 F 22679 X	8 16	202 A 10109 X	8 23
201 F 15909 X	8 17	201 F 22719 X	8 17	202 A 10119 X	8 23
201 F 16019 X	8 17	201 F 22819 X	8 17	202 A 10129 X	8 23
201 F 16069 X	8 17	201 F 22859 X	8 17	202 A 10139 X	8 23
201 F 16169 X	8 17	201 F 22959 X	8 17	202 A 10149 X	8 23
201 F 16269 X	8 17	201 F 22999 X	8 17	202 A 10159 X	8 23
201 F 16379 X	8 19	201 F 23099 X	8 17	202 A 10169 X	8 23
201 F 16429 X	8 19	201 F 23139 X	8 17	202 A 10179 X	8 23
201 F 16529 X	8 19	201 F 23239 X	8 17	202 A 10189 X	8 23
201 F 16629 X	8 19	201 F 23279 X	8 17	202 F 10019 X	8 22
201 F 16739 X	8 19	201 F 23379 X	8 17	202 F 10029 X	8 22
201 F 16789 X	8 19	201 F 23419 X	8 17	202 F 10039 X	8 22
201 F 16889 X	8 19	201 F 23519 X	8 17	202 F 10049 X	8 22
201 F 16989 X	8 19	201 F 23559 X	8 17	202 F 10059 X	8 22
201 F 17099 X	8 19	201 F 23659 X	8 17	202 F 10069 X	8 22
201 F 17149 X	8 19	201 F 23699 X	8 17	202 F 10079 X	8 22
201 F 17249 X	8 19	201 F 23799 X	8 17	202 F 10089 X	8 22

Part Number Section | Page

202 F 10099 X	8 22
202 F 10109 X	8 23
202 F 10119 X	8 23
202 F 10129 X	8 23
202 F 10139 X	8 23
202 F 10149 X	8 23
202 F 10159 X	8 23
202 F 10169 X	8 23
202 F 10179 X	8 23
202 F 10189 X	8 23
220 A 10019 X	8 8
220 A 10029 X	8 8
220 A 10039 X	8 8
220 A 10049 X	8 8
220 A 10059 X	8 8
220 A 10069 X	8 8
220 A 10079 X	8 8
220 A 10089 X	8 8
220 A 10099 X	8 8
220 A 10109 X	8 8
220 A 10119 X	8 8
220 A 10129 X	8 8
220 A 10139 X	8 8
220 A 10149 X	8 8
220 A 10159 X	8 8
220 F 10019 X	8 8
220 F 10029 X	8 8
220 F 10039 X	8 8
220 F 10049 X	8 8
220 F 10059 X	8 8
220 F 10069 X	8 8
220 F 10079 X	8 8
220 F 10089 X	8 8
220 F 10099 X	8 8
220 F 10109 X	8 8
220 F 10119 X	8 8
220 F 10129 X	8 8
220 F 10139 X	8 8
220 F 10149 X	8 8
220 F 10159 X	8 8
220 F 10169 X	8 9
220 F 10179 X	8 9
220 F 10189 X	8 9
220 F 10199 X	8 9
220 F 10209 X	8 9
220 F 10219 X	8 9
220 F 10229 X	8 9
220 F 10239 X	8 9
220 F 10249 X	8 9
220 F 10259 X	8 9
301 A 10089 X	8 10
301 A 10099 X	8 10
301 A 10109 X	8 10

Part Number Section | Page

301 A 10119 X	8 10
302 A 10089 X	8 10
302 A 10099 X	8 10
302 A 10109 X	8 10
302 A 10119 X	8 10
360 X 10029 X	9 6
360 X 10059 X	9 6
360 X 10219 X	9 6
360 X 10329 X	9 4
360 X 10409 X	9 4
360 X 10519 X	9 5
360 X 11019 X	9 5
360 X 11029 X	9 5
360 X 11039 X	9 5
360 X 11049 X	9 4
360 X 11049 X	9 4
360 X 11049 X	9 4
360 X 11059 X	9 4
360 X 11059 X	9 4
360 X 11059 X	9 4
360 X 11059 X	9 4
360 X 11059 X	9 4
360 X 11059 X	9 4
360 X 12369 X	9 7
360 X 20029 X	9 4
36-000070	9 3
36-000080	9 3
36-000130	9 7
360X15119X	9 2
360X15129X	9 2
360X15139X	9 2
360X15149X	9 2
360X15159X	9 2
360X21079X	9 3
360X21089X	9 3
45-000101	3 34
45-000103	3 34
45-000121	3 42
45-000123	3 42
45-000131	3 43
45-000133	3 43
45-000141	3 32
45-000143	3 32
45-000151	3 33
45-000153	3 33
46-000011	1 8
46-000013	1 8
46-000021	1 8
46-000023	1 8
46-000031	1 8
46-000033	1 8
47-100001	2 5
47-100011	2 6
49-000012	6 6

Part Number Section | Page

49-000013	6 6
49-000022	6 4
49-000023	6 4
49-000032	6 5
49-000033	6 5
49-000042	6 7
49-000043	6 7
49-000092	6 6
49-000093	6 6
49-000102	6 4
49-000103	6 4
49-000112	6 5
49-000113	6 5
49-000122	6 7
49-000123	6 7
49-000132	6 6
49-000133	6 6
49-000142	6 4
49-000143	6 4
49-000152	6 5
49-000153	6 5
49-000162	6 7
49-000163	6 7
49-100002	6 10
49-100003	6 10
49-100012	6 9
49-100013	6 9
49-100022	6 8
49-100023	6 8
49-100030	6 11
49-100040	6 11
49-100050	6 11
49-100060	6 11
49-100080	6 11
ATC22 W08 FGE1S5 X	1 5
ATC22 W08 FGE3S5 X	1 5
ATC22 W08 FGRAS5 X	1 7
ATC22 W08 MAE1S5 X	1 4
ATC22 W08 MAE3S5 X	1 4
ATC22 W08 MARAS5 X	1 6
ATC22 W08 MARCS5 X	1 6
ATC22 W08FGRC5 X	1 7
ATC30 W08 FGE1S5 X	1 5
ATC30 W08 FGE3S5 X	1 5
ATC30 W08 FGRAS5 X	1 7
ATC30 W08 MAE1S5 X	1 4
ATC30 W08 MAE3S5 X	1 4
ATC30 W08 MARAS5 X	1 6
ATC30 W08 MARCS5 X	1 6
ATC30 W08FGRC5 X	1 7
ATC34 W08 FGE1S5 X	1 5
ATC34 W08 FGE3S5 X	1 5
ATC34 W08 FGRAS5 X	1 7

PART NUMBERS

Part Number Section | Page

ATC34 W08 MAE1S5 X	1 4
ATC34 W08 MAE3S5 X	1 4
ATC34 W08 MARAS5 X	1 6
ATC34 W08 MARCS5 X	1 6
ATC34 W08 FGRC5 X	1 7
CPD24 W09 MARASK9 X	3 38
CPD24 W09 MARCSK9 X	3 38
CPD24 W09 MGRASK9 X	3 40
CPD24 W09 MGRCSK9 X	3 40
CPD26 W11 MARASK9 X	3 39
CPD26 W11 MARCSK9 X	3 39
CPD26 W11 MGRASK9 X	3 41
CPD26 W11 MGRCSK9 X	3 41
CPH38 W23 FARARK9 X	3 13
CPH38 W23 FARASK9 X	3 12
CPH38 W23 FARCRK9 X	3 13
CPH38 W23 FARCSK9 X	3 12
CPH38 W23 FGE1SH9 X	3 29
CPH38 W23 FGE1SK9 X	3 27
CPH38 W23 FGE1SN9 X	3 28
CPH38 W23 FGE3SH9 X	3 29
CPH38 W23 FGE3SK9 X	3 27
CPH38 W23 FGE3SN9 X	3 28
CPH38 W23 FGRASH9 X	3 22
CPH38 W23 FGRASK9 X	3 20
CPH38 W23 FGRASN9 X	3 21
CPH38 W23 FGRC5H9 X	3 22
CPH38 W23 FGRC5K9 X	3 20
CPH38 W23 FGRC5N9 X	3 21
CPH38 W23 MARARK9 X	3 9
CPH38 W23 MARASK9 X	3 8
CPH38 W23 MARCRK9 X	3 9
CPH38 W23 MARCSK9 X	3 8
CPH38 W23 MGE1SK9 X	3 25
CPH38 W23 MGE3SK9 X	3 25
CPH38 W23 MGRASK9 X	3 18
CPH38 W23 MGRCSK9 X	3 18
CPH47 W23 FARARK9 X	3 15
CPH47 W23 FARARN9 X	3 17
CPH47 W23 FARASK9 X	3 14
CPH47 W23 FARASN9 X	3 16
CPH47 W23 FARCRK9 X	3 15
CPH47 W23 FARCRN9 X	3 17
CPH47 W23 FARCSK9 X	3 14
CPH47 W23 FARCSN9 X	3 16
CPH47 W23 FGE1SK9 X	3 30
CPH47 W23 FGE1SN9 X	3 31
CPH47 W23 FGE3SK9 X	3 30
CPH47 W23 FGE3SN9 X	3 31
CPH47 W23 FGRASK9 X	3 23
CPH47 W23 FGRASN9 X	3 24
CPH47 W23 FGRC5K9 X	3 23

Part Number Section | Page

CPH47 W23 FGRC5N9 X	3 24
CPH47 W23 FXXXSH9 X	3 35
CPH47 W23 MARARK9 X	3 11
CPH47 W23 MARASK9 X	3 10
CPH47 W23 MARCRK9 X	3 11
CPH47 W23 MARCSK9 X	3 10
CPH47 W23 MGE1SK9 X	3 26
CPH47 W23 MGE3SK9 X	3 26
CPH47 W23 MGRASK9 X	3 19
CPH47 W23 MGRCSK9 X	3 19
CPZC 0822FA X	3 36
CPZC 0822FC X	3 36
CPZC 1612FA X	3 36
CPZC 1612FC X	3 36
CPZC 1614FA X	3 36
CPZC 1614FC X	3 36
CPZC 1616FA X	3 36
CPZC 1616FC X	3 36
CPZC 1620FA X	3 36
CPZC 1620FC X	3 36
CPZS 0170 X	3 37
CPZS 0270 X	3 37
CPZS 0370 X	3 37
CPZS 0470 X	3 37
CPZS 5170 X	3 37
CPZS 5270 X	3 37
CPZS 5370 X	3 37
CPZS 5470 X	3 37
DLS 1XPSAG04 X	8 11
DLS 1XSSAG04 X	8 11
DLS 2XPSAG04 X	8 11
DLS 2XSSAG04 X	8 11
DLS 3XPSAG04 X	8 11
DLS 3XSSAG04 X	8 11
DLS 4XPSAG04 X	8 11
DLS 4XSSAG04 X	8 11



Internet www.conec.com

Use the fastest connection to reach us. Behind this address you'll find a company with an international well-known name.

Our web side will support you to find all information about us and our product range.

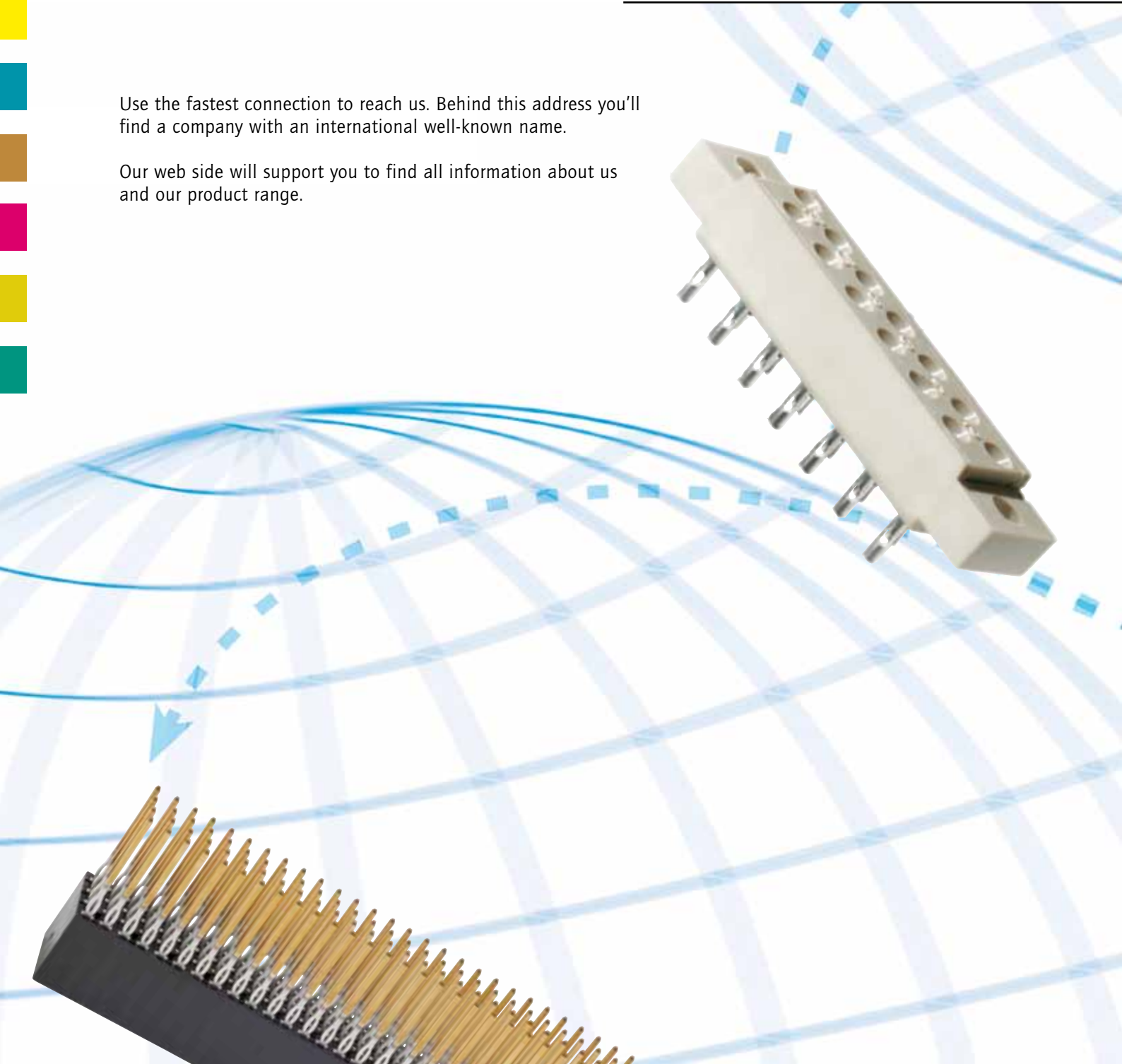
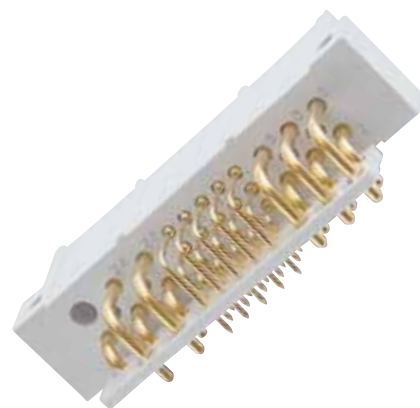

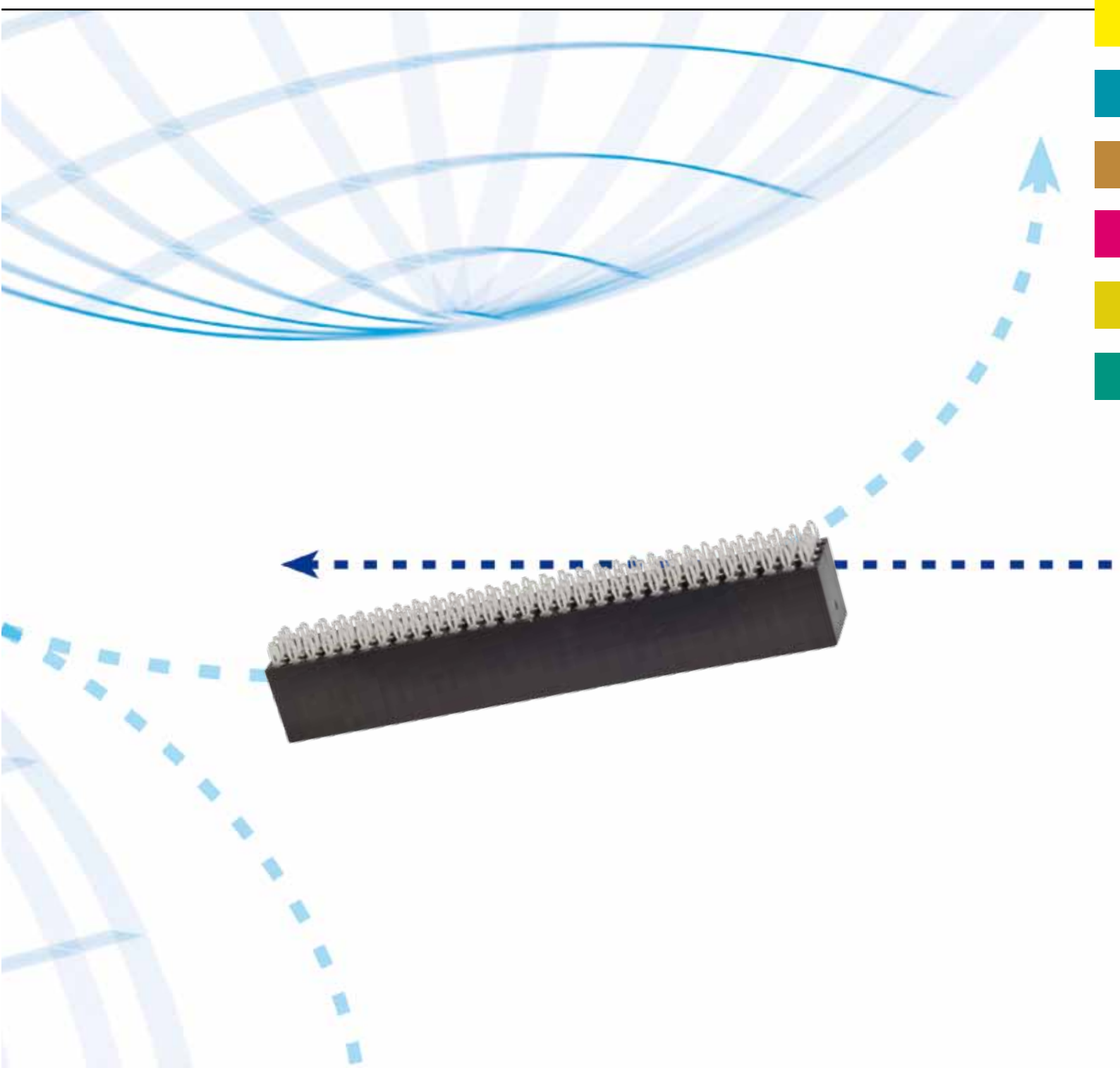

CONEC

Elektronische Bauelemente GmbH
Ostenfeldmark 16
59557 Lippstadt
Germany

Tel. +49 2941 765-0
Fax +49 2941 76565
E-Mail info@conec.de
www.conec.com

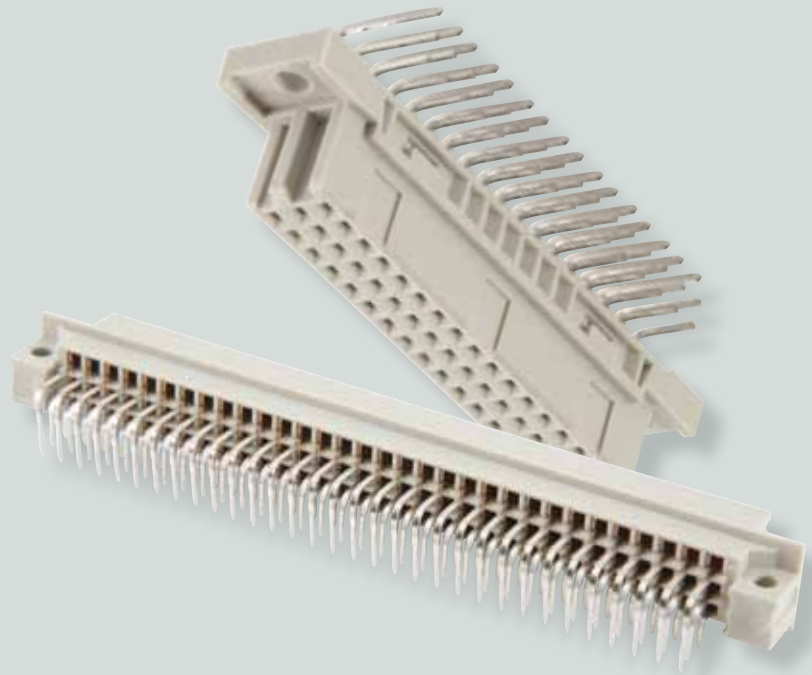

CONEC Corporation

125 Sun Pac Blvd.
Brampton Ontario
Canada L6S 5Z6
Tel. +1 905 790 2200
Fax +1 905 790 2201
E-Mail info@conec.com

CONEC

343 Technology Drive
Garner, NC, USA 27529
Tel. +1 919 460 8800
Fax +1 919 460 0141
E-Mail info@conec.com

CONEC (UK) Limited

Ringway House East
Kelvin Road
Newbury, Berkshire
RG14 2DB
Tel. +44 1635 36929
Fax +44 1635 36925
E-Mail info@conec.co.uk

CONEC Polska Sp. zo.o

ul.Szmaragdowa 10
52-215 Wrocław
Tel. +48 713744045
Fax +48 713744049
E-Mail info@conec.pl

CONEC s.r.o.

Loucka 119
76325 Ujezd
Czech Republic
Tel. +42 0577 350132
Fax +42 0577 350134
E-Mail info@conec.cz

CONEC France SARL

202 Rue des Chevreuils
30320 Poulx
Tel. +33 9 75267217
Fax +33 4 66570916
E-Mail info@conec.fr

CONEC (Shanghai)

Int. Trading Co., Ltd.
Rm. 715 Yongding Bldg.
No. 3388 Gong He Xin Rd.
200436 Shanghai
Tel. +86 21 66300930
Fax +86 21 66300911
E-Mail info@conec.cn

CONEC GmbH Schatz Electronic

Schubertstr. 14a
99096 Erfurt
Tel. +49 361 340110
Fax +49 361 340111
E-Mail info@schatz-electronic.de