

REVISIONS					
REV	ECO	DESCRIPTION	DATE	BY	APPR
A3	-	RELEASE NEW DWG FORMAT	18/SEP/13	DRP	
A4	-	UPDATE DRAWING	10/MAY/19	JOE	TOMMY
A5	C1437S	INCREASE LIMIT RIBS	22/SEP/21	RONALD	TOMMY

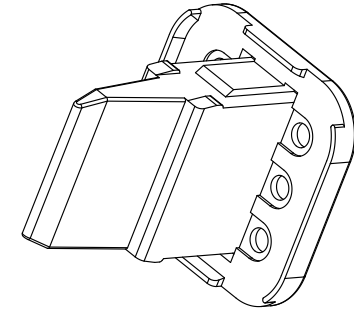
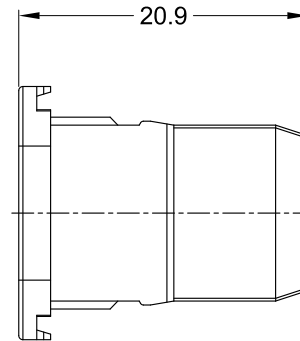
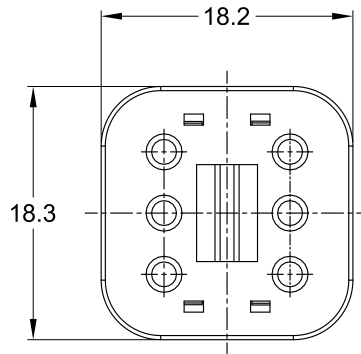
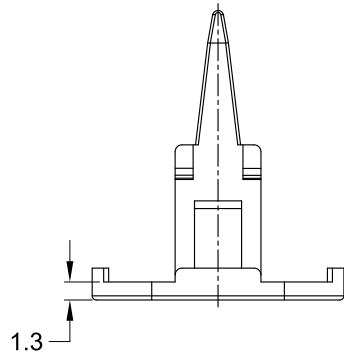

TITLE: S-WEDGELOCK, 6 POSITION, AT SERIES
 DWG NO.: AW6S
 REV: A5
 SH: 1
 OF: 1

NOTES: UNLESS OTHERWISE SPECIFIED

1. MATERIAL: THERMOPLASTIC; COLOR: GREEN
2. RoHS COMPLIANT
3. CAVITIES: 6
4. KEYED: N/A
5. USE WITH CONNECTORS AT06-6S*
(* = MODIFICATIONS AND COLORS)
6. ALL DIMENSIONS ARE FOR REFERENCE USE ONLY.

QUANTITY	AW6S	DESCRIPTION	ITEM																		
MATERIALS LIST																					
UNLESS OTHERWISE SPECIFIED: 1) All dimensions are in metric (mm). 2) Tolerances are as follows: 1 PL DEC ±0.30 Fractions ±1/64 2 PL DEC ±0.15 Angles ±1° 3 PL DEC ±0.08 3) Note reference =		<table border="1"> <tr> <th>SIGNATURES</th> <th>DATE</th> </tr> <tr> <td>DRAWN: RONALD</td> <td>22/SEP/21</td> </tr> <tr> <td>CHECKED: ORION</td> <td>23/SEP/21</td> </tr> <tr> <td>ENGINEER:</td> <td></td> </tr> <tr> <td>APPROVAL: TOMMY</td> <td>24/SEP/21</td> </tr> <tr> <td>CUSTOMER:</td> <td></td> </tr> </table>		SIGNATURES	DATE	DRAWN: RONALD	22/SEP/21	CHECKED: ORION	23/SEP/21	ENGINEER:		APPROVAL: TOMMY	24/SEP/21	CUSTOMER:							
SIGNATURES	DATE																				
DRAWN: RONALD	22/SEP/21																				
CHECKED: ORION	23/SEP/21																				
ENGINEER:																					
APPROVAL: TOMMY	24/SEP/21																				
CUSTOMER:																					
MATERIAL SPECIFICATIONS: PROCESS SPECIFICATIONS: NEXT ASSY:		<table border="1"> <tr> <td colspan="2" style="text-align: center;">Amphenol</td> </tr> <tr> <td colspan="2" style="text-align: center;">Sine Systems - www.amphenol-sine.com 44724 Morley Drive Clinton Township, MI 48036</td> </tr> <tr> <td colspan="2" style="text-align: center;">S-WEDGELOCK, 6 POS ITION, AT SERIES</td> </tr> <tr> <td>SIZE</td> <td>TYPE</td> <td>DWG NO.</td> <td>REVISION</td> </tr> <tr> <td>B</td> <td>C-</td> <td>AW6S</td> <td>A5</td> </tr> <tr> <td>SCALE</td> <td colspan="2">NONE</td> <td>SHEET 1 OF 1</td> </tr> </table>		Amphenol		Sine Systems - www.amphenol-sine.com 44724 Morley Drive Clinton Township, MI 48036		S-WEDGELOCK, 6 POS ITION, AT SERIES		SIZE	TYPE	DWG NO.	REVISION	B	C-	AW6S	A5	SCALE	NONE		SHEET 1 OF 1
Amphenol																					
Sine Systems - www.amphenol-sine.com 44724 Morley Drive Clinton Township, MI 48036																					
S-WEDGELOCK, 6 POS ITION, AT SERIES																					
SIZE	TYPE	DWG NO.	REVISION																		
B	C-	AW6S	A5																		
SCALE	NONE		SHEET 1 OF 1																		