

VMMK-1225

0.5 to 26 GHz Low Noise E-PHEMT in a Wafer Scale Package



Data Sheet



Description

Avago Technologies has combined its industry leading E-pHEMT technology with a revolutionary chip scale package. The VMMK-1225 can produce an LNA with high dynamic range, high gain and low noise figure that operates off of a single position DC power supply. The GaAsCap wafer scale sub-miniature leadless package is small and ultra thin, yet can be handled and placed with standard 0402 pick and place assembly.

The use of 0.25 micron gates allow a ultra low noise figure (below 1dB from 500 MHz to 12 GHz) with respectable associated gain. With a flat transconductance over bias and frequency the VMMK-1225 provides excellent linearity of over 22 dBm and power over 10 dBm at one dB compression. This product is easy to use since it requires only positive DC voltages for bias and low matching coefficients for simple impedance matching to 50 Ω systems. The VMMK-1225 is intended for any 500MHz to 26.5GHz application including 802.11abgn WLAN, WiMax, BWA 802.16 & 802.20 and military applications.

WLP 0402, 1mm x 0.5mm x 0.25 mm

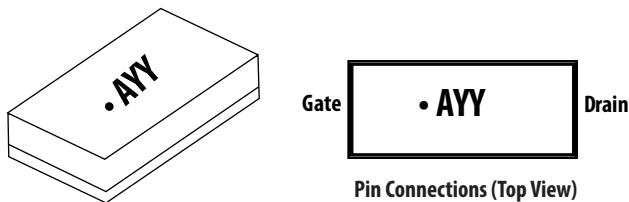

Notes: Top view package marking provides orientation

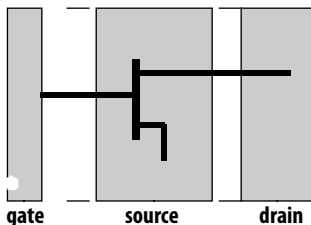

Notes:
"A" = Device Code
"YY" = Year Code

Features

- Sub-miniature 0402 (1mm x 0.5mm) Surface Mount Leadless Package
- Low height (0.25mm)
- Frequency Range DC to 26.5 GHz
- Enhancement Mode^[1]
- 0.25 micron gate length
- Tape and Reel packaging option available

Specifications

- 0.87dB Fmin
- 11dB Ga
- +23 dBm output 3rd order intercept
- +8 dBm output power

Applications

- 2.4 GHz, 3.5GHz, 5-6GHz WLAN and WiMax notebook computer, access point and mobile wireless applications
- DBS 10 to 13 GHz receivers
- VSAT and SATCOM 13 to 18 GHz systems
- 802.16 & 802.20 BWA systems
- WLL and MMDS Transceivers
- General purpose discrete E-pHEMT for other ultra low noise applications

Notes:

1. The Avago enhancement mode pHEMT devices do not require a negative gate bias voltage as they are "normally off". They can help simplify the design and reduce the cost of receivers and transmitters in many applications from 500 MHz to 18 GHz



Attention: Observe precautions for handling electrostatic sensitive devices.

ESD Machine Model = 20 V (class A)
ESD Human Body Model = 100 V (Class 0)
Refer to Avago Application Note A004R:
Electrostatic Discharge, Damage and Control.

VMMK-1225 Absolute Maximum Ratings

Sym	Parameters/Condition	Unit	Max
Vds	Drain-Source Voltage ^[2]	V	5
Vgs	Gate-Source Voltage ^[2]	V	-5 to 1
Vgd	Gate-Drain Voltage ^[2]	V	-5 to 1
I _{ds}	Drain Current ^[2]	mA	50
I _{gs}	Gate Current	mA	0.8
P _{dn}	Total Power Dissipation ^[3]	mW	250
P _{in}	RF CW Input Power Max	dBm	10
T _{ch}	Max channel temperature	C	+150
θ _{jc}	Thermal Resistance ^[4]	C/W	200

Notes:

1. Operation in excess of any of these conditions may result in permanent damage to this device.
2. Assumes DC quiescent conditions
3. Ambient operational temperature T_A=25 °C unless otherwise noted.
4. Thermal resistance measured using 150 °C Liquid Crystal Measurement Method
5. The device can handle + 10 dBm RF input power provided I_{gs} is limited to 1 mA

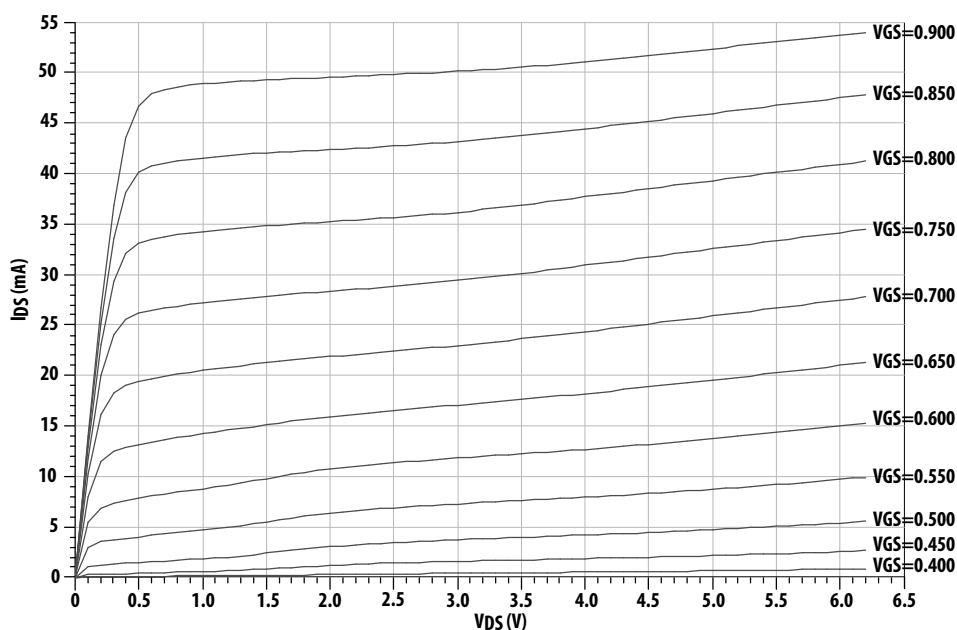

Figure 1. Typical I-V Curves. (V_{GS}=0.05 V per step)

VMMK-1225 RF Specifications (on board) [6,7]

T_A = 25°C, Freq = 12 GHz, V_{ds} = 2V & I_{ds} = 20mA (unless otherwise specified)

Sym	Parameters/Condition	Units	Min	Typ.	Max
V _{gs}	Gate Voltage	V	0.58	0.68	0.78
I _{gs}	Gate Current	uA		2.0	
G _m	Transconductance	mS		120	
G _a	Associated Gain	dB	8.7	11	12.2
NF	Noise Figure	dB		1.0	2.3
F _{min}	Noise Figure min	dB		0.87	
P-1dB	1dB Compressed Output Power	dBm		+8	
OIP3	Output 3rd Order Intercept Point	dBm		+23	

Notes:

6. Specifications are derived from measurements in a test circuit.
7. All tested parameters guaranteed with measurement accuracy ± 0.5 dB for gain.

Product Consistency Distribution Charts [1]

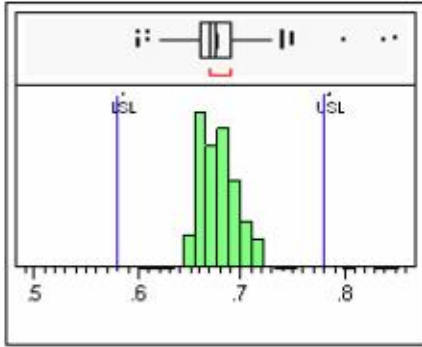

Figure 2. Gate Voltage @ $V_{ds} = 2V$ & $I_{ds} = 20mA$, LSL=0.58, Nominal=0.67, USL=0.78, CPK=1.957

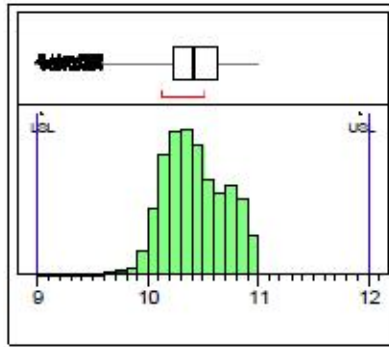

Figure 3. Gain @ 12 GHz, LSL=8.7, Nominal=10.4, USL=12.2, CPK=1.7

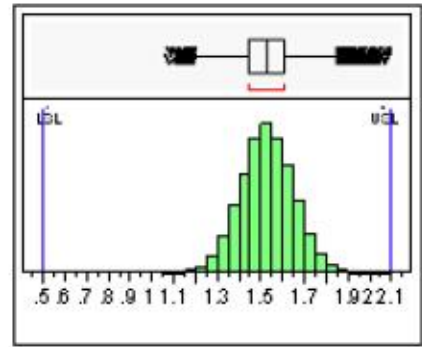

Figure 4. NF @ 12 GHz, Nominal=1.52, USL=2.3, CPK=1.55

Note:

1. Distribution data based at least 500 part sample size from two wafers during initial characterization of this product. Future wafers allocated to this product may have nominal values anywhere between upper and lower limits.

VMMK-1225 Typical Performance Curve

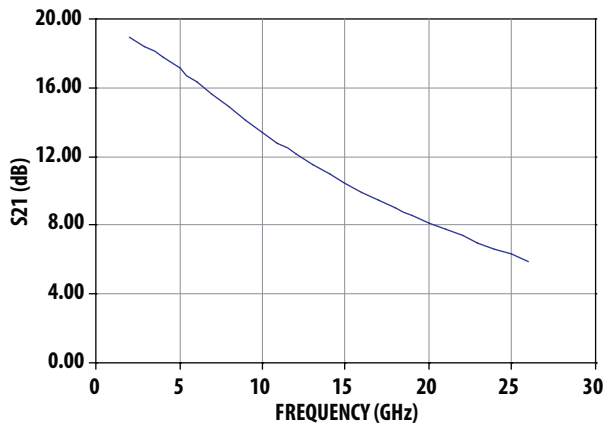

Figure 5. S21 vs. Frequency at 2V, 20mA

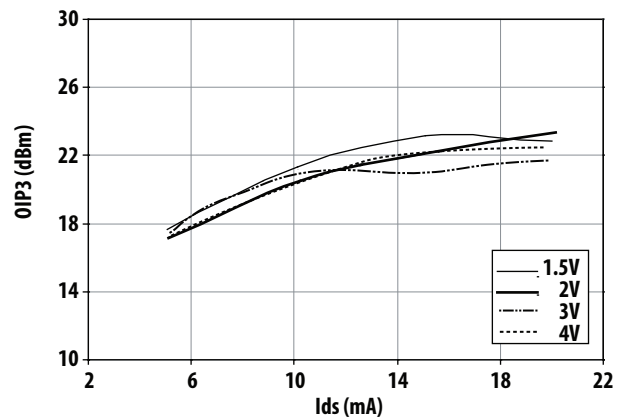

Figure 6. OIP3 and I_{ds} at 12 GHz

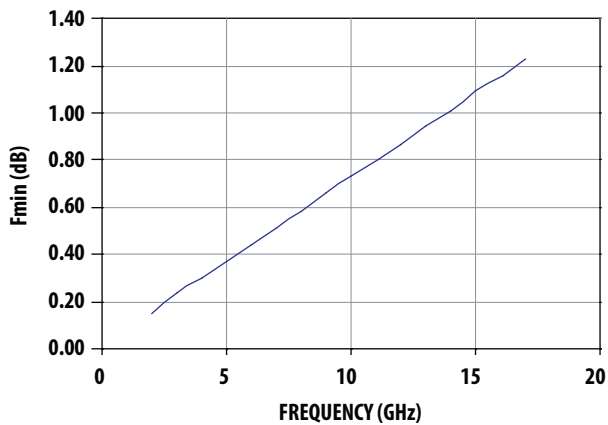

Figure 7. Fmin vs. Frequency at 2V, 20mA

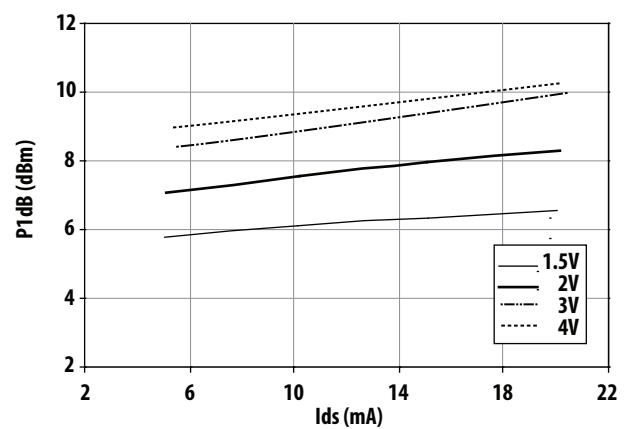

Figure 8. P1dB vs. I_{ds} at 12 GHz

VMMK-1225 Typical Performance Curve

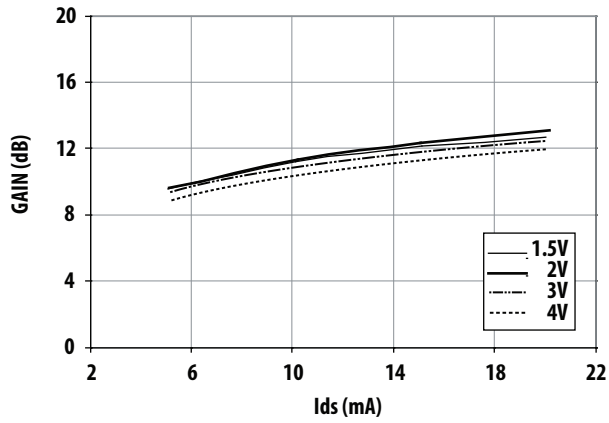

Figure 9. Gain vs. Ids at 12 GHz

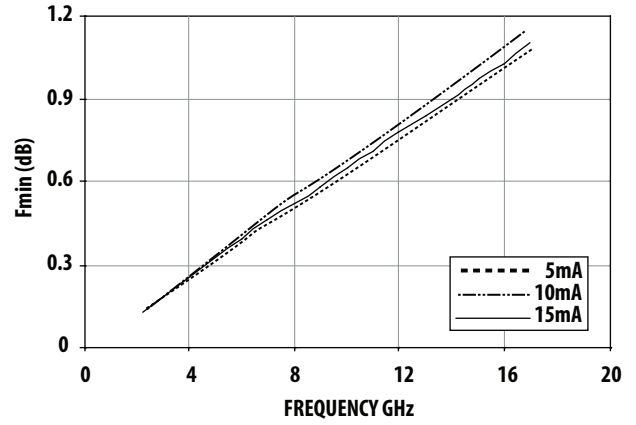

Figure 10. NFmin vs. Frequency at 2V

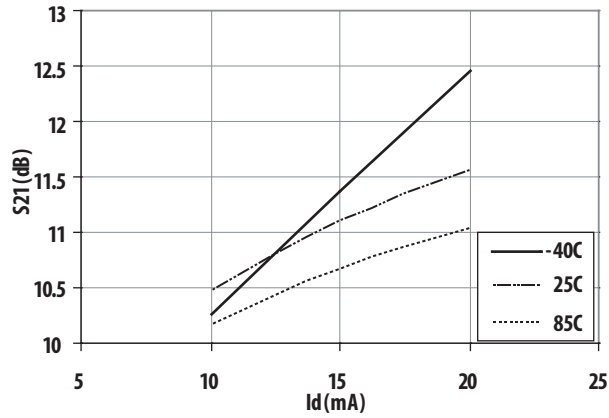

Figure 11. S21 vs. Ids at 12 GHz over temp at 2V

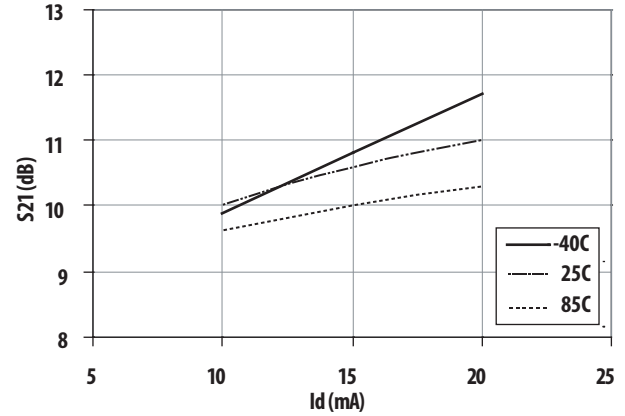

Figure 12. S21 vs. Ids at 12 GHz over temp at 3V

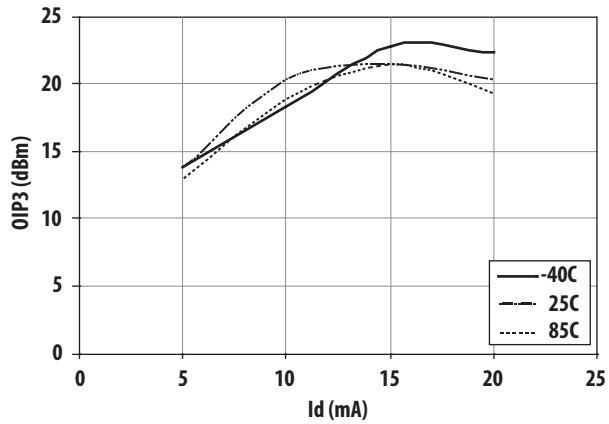

Figure 13. OIP3 vs. Ids at 12 GHz over temp at 2V

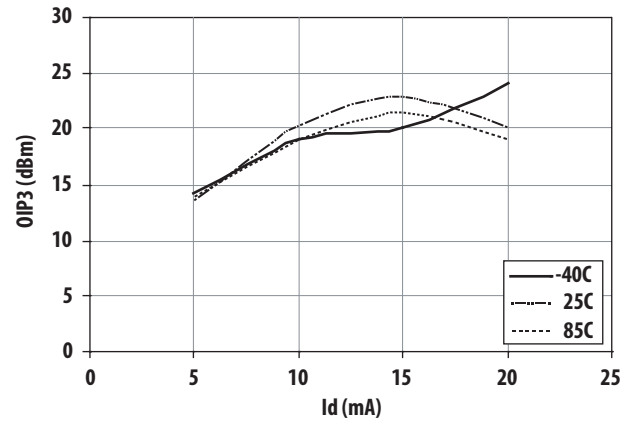

Figure 14. OIP3 vs. Ids at 12 GHz over temp at 3V

VMMK-1225 Typical Scattering Parameters and Noise Parameters, $T_A=25^\circ\text{C}$, $V_{ds}=2\text{V}$, $I_{ds}=20\text{mA}$ [1]

Freq GHz	S11		S21		S12		S22		MSG/MAG dB	
	Mag.	Ang.	dB	Mag.	Ang.	Mag.	Ang.	Mag.		Ang.
2	0.95	-42.72	19.01	8.92	148.51	0.03	62.56	0.78	-22.76	33.45
3	0.92	-62.66	18.46	8.38	134.49	0.05	50.55	0.74	-33.18	30.07
4	0.88	-81.48	17.82	7.78	121.19	0.06	39.47	0.69	-42.88	27.08
5	0.85	-98.49	17.11	7.17	109.28	0.07	29.48	0.65	-51.36	24.89
6	0.81	-114.47	16.36	6.58	98.09	0.07	20.68	0.60	-59.27	23.06
7	0.79	-129.09	15.64	6.05	87.68	0.08	12.23	0.56	-66.63	21.51
8	0.77	-142.63	14.91	5.56	77.86	0.08	4.59	0.53	-73.61	20.20
9	0.75	-155.20	14.16	5.11	68.55	0.08	-2.42	0.50	-80.46	19.02
10	0.74	-166.71	13.47	4.71	59.82	0.08	-8.97	0.47	-86.77	18.01
11	0.73	-177.38	12.81	4.37	51.64	0.08	-15.21	0.45	-92.81	17.11
12	0.73	172.73	12.17	4.06	43.68	0.08	-20.51	0.43	-98.99	16.34
13	0.73	163.36	11.58	3.79	36.07	0.08	-25.92	0.42	-104.88	15.64
14	0.72	154.49	11.00	3.55	28.75	0.08	-31.20	0.40	-110.71	15.00
15	0.72	146.17	10.48	3.34	21.67	0.07	-35.48	0.40	-116.24	14.43
16	0.73	137.93	9.99	3.16	14.53	0.07	-39.63	0.39	-121.82	13.96
17	0.73	129.96	9.52	2.99	7.56	0.07	-43.76	0.38	-127.93	13.52
18	0.73	122.52	9.05	2.83	0.89	0.07	-47.66	0.38	-133.93	13.09
19	0.74	114.96	8.61	2.69	-5.89	0.07	-51.22	0.38	-139.67	12.70
20	0.74	107.64	8.19	2.57	-12.53	0.07	-54.78	0.38	-145.51	12.36
21	0.75	100.69	7.77	2.44	-19.05	0.06	-58.37	0.38	-151.20	12.05
22	0.76	93.20	7.38	2.34	-25.66	0.06	-62.24	0.37	-156.42	11.72
23	0.76	86.08	7.01	2.24	-32.37	0.06	-65.41	0.37	-162.46	11.42
24	0.77	79.35	6.66	2.15	-38.72	0.06	-69.57	0.38	-168.85	11.26
25	0.78	72.88	6.31	2.07	-45.30	0.06	-72.63	0.38	-175.43	10.99
26	0.78	66.18	5.94	1.98	-51.81	0.06	-76.40	0.38	178.40	10.70

Typical Noise Parameters

Freq GHz	Fmin dB	Γ opt Mag.	Γ opt Ang.	Rn/50	Ga dB
2	0.15	0.78	16.80	0.19	21.31
3	0.23	0.707	24	0.19	19.92
4	0.3	0.637	31.7	0.18	18.63
5	0.37	0.573	40	0.17	17.45
6	0.44	0.515	48.8	0.16	16.37
7	0.51	0.462	58.2	0.15	15.41
8	0.58	0.415	68.1	0.14	14.55
9	0.66	0.373	78.6	0.13	13.79
10	0.73	0.338	89.7	0.12	13.15
11	0.8	0.308	101.3	0.11	12.61
12	0.87	0.284	113.5	0.1	12.17
13	0.94	0.265	126.2	0.09	11.85
14	1.01	0.252	139.5	0.09	11.63
15	1.09	0.245	153.4	0.08	11.52
16	1.16	0.244	167.8	0.08	11.51
17	1.23	0.248	-177.3	0.08	11.62

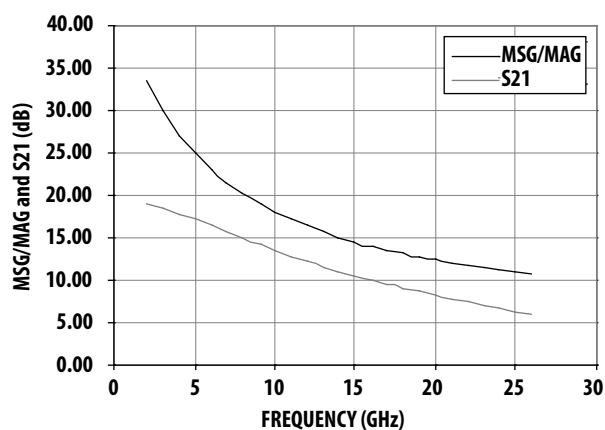

Figure 15. MSG/MAG and S21 vs Frequency at 2V 20mA

Note:

1. S-parameters are measured in 50 Ohm test environment.

VMMK-1225 Typical Scattering Parameters and Noise Parameters, $T_A=25^\circ\text{C}$, $V_{ds}=1.5\text{V}$, $I_{ds}=20\text{mA}$ [1]

Freq GHz	S11			S21		S12		S22		MSG/MAG dB
	Mag.	Ang.	dB	Mag.	Ang.	Mag.	Ang.	Mag.	Ang.	
2	0.95	-41.45	19.16	9.07	149.23	0.04	63.03	0.75	-25.07	35.71
3	0.92	-60.81	18.64	8.55	135.54	0.05	51.14	0.71	-36.68	32.36
4	0.88	-79.22	18.03	7.97	122.51	0.06	40.08	0.66	-47.70	29.32
5	0.85	-95.99	17.35	7.37	110.76	0.07	30.08	0.62	-57.44	27.04
6	0.82	-111.80	16.64	6.80	99.69	0.08	20.91	0.57	-66.62	25.10
7	0.79	-126.35	15.94	6.26	89.35	0.09	12.49	0.53	-75.19	23.45
8	0.77	-139.88	15.23	5.77	79.62	0.09	4.67	0.49	-83.31	22.05
9	0.75	-152.58	14.50	5.31	70.33	0.09	-2.71	0.46	-91.35	20.76
10	0.74	-164.13	13.82	4.91	61.64	0.09	-9.42	0.43	-98.74	19.66
11	0.73	-174.92	13.16	4.55	53.54	0.09	-15.86	0.41	-105.72	18.68
12	0.72	175.03	12.54	4.24	45.64	0.09	-21.52	0.38	-112.70	17.84
13	0.72	165.58	11.95	3.96	38.11	0.09	-27.32	0.37	-119.39	17.08
14	0.72	156.60	11.38	3.71	30.88	0.09	-32.92	0.35	-125.81	16.37
15	0.71	148.19	10.86	3.49	23.83	0.09	-37.75	0.34	-131.85	15.76
16	0.72	139.78	10.37	3.30	16.76	0.09	-42.36	0.33	-138.18	15.26
17	0.72	131.83	9.89	3.12	9.84	0.08	-47.16	0.33	-144.56	14.79
18	0.72	124.31	9.42	2.96	3.32	0.08	-51.18	0.32	-150.78	14.34
19	0.73	116.48	8.97	2.81	-3.41	0.08	-55.89	0.32	-157.20	13.95
20	0.73	109.16	8.55	2.68	-9.91	0.08	-60.43	0.32	-163.11	13.60
21	0.74	102.09	8.15	2.55	-16.35	0.08	-64.86	0.32	-169.12	13.28
22	0.75	94.51	7.76	2.44	-22.84	0.08	-69.11	0.31	-174.70	12.90
23	0.75	87.43	7.38	2.34	-29.48	0.07	-73.28	0.31	-178.98	12.59
24	0.76	80.52	7.03	2.25	-35.76	0.07	-77.84	0.31	-172.70	12.42
25	0.76	74.22	6.67	2.16	-42.19	0.07	-82.02	0.32	166.48	12.14
26	0.77	67.45	6.31	2.07	-48.60	0.07	-86.38	0.32	159.81	11.88

Typical Noise Parameters

Freq GHz	Fmin dB	Γ_{opt} Mag.	Γ_{opt} Ang.	Rn/50	Ga dB
2	0.15	0.81	16.80	0.18	21.28
3	0.21	0.734	24	0.18	19.91
4	0.28	0.665	31.8	0.17	18.65
5	0.34	0.601	40	0.17	17.49
6	0.41	0.543	48.8	0.16	16.43
7	0.47	0.49	58.2	0.15	15.48
8	0.54	0.442	68	0.14	14.64
9	0.6	0.4	78.4	0.13	13.9
10	0.67	0.363	89.3	0.12	13.27
11	0.73	0.332	100.7	0.11	12.74
12	0.8	0.307	112.6	0.1	12.32
13	0.86	0.286	125.1	0.09	12
14	0.93	0.272	138.1	0.08	11.79
15	0.99	0.262	151.6	0.08	11.68
16	1.06	0.259	165.6	0.08	11.68
17	1.12	0.26	-179.8	0.08	11.79

Note:

1. S-parameters are measured in 50 Ohm test environment.

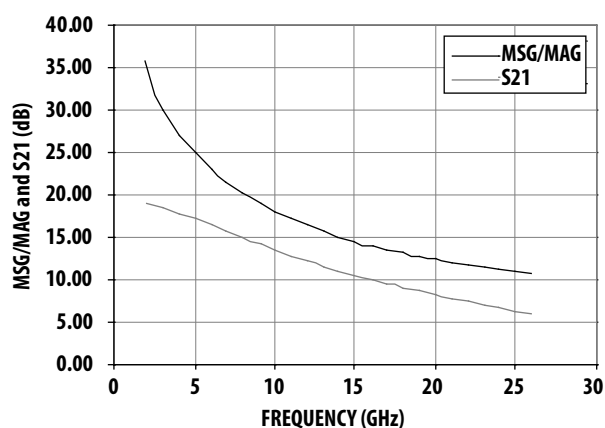

Figure 16. MSG/MAG and S21 vs Frequency at 1.5V 20mA

VMMK-1225 Typical Scattering Parameters and Noise Parameters, $T_A=25^\circ\text{C}$, $V_{ds}=3\text{V}$, $I_{ds}=20\text{mA}$ [1]

Freq GHz	S11			S21		S12		S22		MSG/MAG
	Mag.	Ang.	dB	Mag.	Ang.	Mag.	Ang.	Mag.	Ang.	dB
2	0.95	-44.16	18.65	8.56	147.52	0.03	62.38	0.80	-20.48	33.25
3	0.92	-64.98	18.10	8.03	132.99	0.04	49.96	0.76	-29.83	29.80
4	0.87	-84.86	17.43	7.44	119.11	0.05	38.25	0.71	-38.52	26.77
5	0.84	-103.02	16.69	6.83	106.61	0.06	28.18	0.67	-46.15	24.51
6	0.81	-119.88	15.89	6.23	94.91	0.06	19.19	0.63	-53.21	22.66
7	0.78	-135.19	15.11	5.69	84.12	0.07	10.75	0.59	-59.80	21.11
8	0.76	-149.25	14.32	5.20	74.00	0.07	3.23	0.56	-66.03	19.78
9	0.75	-161.91	13.51	4.74	64.50	0.07	-3.86	0.53	-72.27	18.59
10	0.74	-173.16	12.77	4.35	55.73	0.07	-9.95	0.52	-78.27	17.60
11	0.74	176.55	12.05	4.01	47.51	0.07	-15.58	0.50	-84.02	16.71
12	0.74	167.27	11.39	3.71	39.54	0.06	-20.57	0.49	-90.13	15.98
13	0.74	158.74	10.77	3.46	32.00	0.06	-25.46	0.48	-96.11	15.29
14	0.74	150.81	10.19	3.23	24.84	0.06	-29.82	0.47	-101.79	14.67
15	0.73	143.18	9.66	3.04	17.76	0.06	-33.52	0.47	-107.60	14.12
16	0.74	135.70	9.16	2.87	10.68	0.06	-36.60	0.47	-113.31	13.64
17	0.74	128.49	8.71	2.73	3.81	0.06	-39.53	0.47	-118.80	13.23
18	0.74	121.25	8.27	2.59	-2.90	0.05	-42.17	0.47	-124.55	12.80
19	0.74	113.89	7.85	2.47	-9.79	0.05	-44.68	0.48	-130.27	12.44
20	0.75	106.67	7.46	2.36	-16.52	0.05	-47.26	0.48	-136.04	12.11
21	0.75	99.29	7.07	2.26	-23.30	0.05	-50.61	0.48	-141.26	11.78
22	0.75	91.51	6.72	2.17	-30.13	0.05	-52.95	0.49	-146.30	11.46
23	0.75	83.74	6.37	2.08	-37.20	0.05	-55.09	0.49	-151.70	11.13
24	0.76	75.90	6.04	2.00	-43.95	0.05	-58.00	0.49	-157.00	10.91
25	0.76	68.74	5.69	1.93	-50.88	0.05	-60.53	0.49	-163.41	10.67
26	0.77	61.14	5.33	1.85	-57.76	0.05	-63.55	0.49	-168.90	10.37

Typical Noise Parameters

Freq GHz	Fmin dB	Γ opt Mag.	Γ opt Ang.	Rn/50	Ga dB
2	0.14	0.783	16.4	0.19	20.73
3	0.21	0.704	23.4	0.18	19.33
4	0.29	0.632	30.9	0.18	18.03
5	0.37	0.565	39.1	0.17	16.85
6	0.45	0.505	48	0.16	15.77
7	0.53	0.45	57.4	0.15	14.81
8	0.61	0.402	67.6	0.14	13.95
9	0.68	0.359	78.3	0.13	13.21
10	0.76	0.322	89.7	0.12	12.57
11	0.84	0.291	101.7	0.11	12.04
12	0.92	0.266	114.3	0.11	11.62
13	1	0.247	127.6	0.1	11.31
14	1.08	0.234	141.5	0.09	11.12
15	1.15	0.227	156	0.09	11.03
16	1.23	0.226	171.2	0.09	11.05
17	1.31	0.231	-173	0.09	11.18

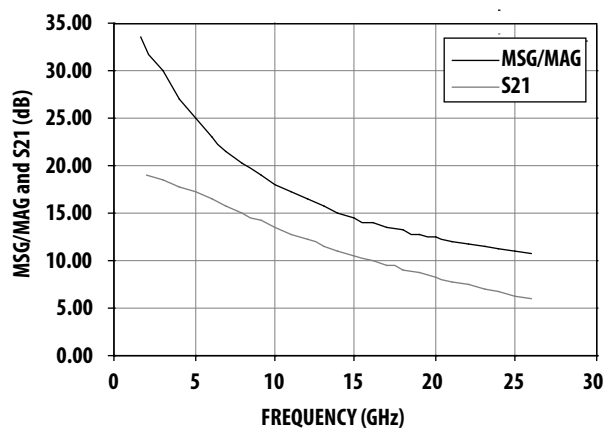

Figure 17. MSG/MAG and S21 vs Frequency at 3V 20mA

Note:

1. S-parameters are measured in 50 Ohm test environment.

VMMK-1225 Typical Scattering Parameters and Noise Parameters, $T_A=25^\circ\text{C}$, $V_{ds}=4\text{V}$, $I_{ds}=20\text{mA}$ [1]

Freq GHz	S11			S21		S12		S22		MSG/MAG
	Mag.	Ang.	dB	Mag.	Ang.	Mag.	Ang.	Mag.	Ang.	dB
2	0.95	-45.53	18.45	8.37	146.63	0.03	61.48	0.81	-19.63	33.11
3	0.91	-66.85	17.86	7.82	131.81	0.04	49.37	0.77	-28.48	29.56
4	0.87	-87.06	17.16	7.21	117.72	0.05	37.71	0.73	-36.59	26.53
5	0.83	-105.43	16.37	6.59	105.08	0.05	27.63	0.69	-43.74	24.25
6	0.80	-122.38	15.55	5.99	93.35	0.06	18.64	0.65	-50.37	22.41
7	0.78	-137.72	14.73	5.45	82.50	0.06	10.37	0.62	-56.59	20.86
8	0.76	-151.66	13.93	4.97	72.41	0.06	3.27	0.59	-62.52	19.54
9	0.75	-164.20	13.11	4.52	62.92	0.06	-3.88	0.56	-68.53	18.35
10	0.74	-175.38	12.36	4.15	54.12	0.06	-9.86	0.55	-74.35	17.39
11	0.74	174.53	11.64	3.82	45.87	0.06	-14.98	0.53	-80.07	16.51
12	0.74	165.32	10.97	3.54	37.88	0.06	-19.88	0.52	-86.09	15.78
13	0.74	156.90	10.34	3.29	30.28	0.06	-23.98	0.52	-92.05	15.09
14	0.74	149.09	9.76	3.08	23.07	0.06	-28.30	0.51	-97.69	14.48
15	0.74	141.52	9.23	2.89	15.94	0.05	-31.31	0.51	-103.56	13.94
16	0.74	134.12	8.72	2.73	8.83	0.05	-34.13	0.51	-109.35	13.46
17	0.74	126.90	8.27	2.59	1.87	0.05	-35.42	0.51	-114.79	13.05
18	0.74	119.69	7.82	2.46	-4.91	0.05	-38.50	0.51	-120.61	12.65
19	0.74	112.42	7.40	2.34	-11.91	0.05	-40.30	0.52	-126.46	12.27
20	0.75	105.25	7.00	2.24	-18.68	0.05	-42.50	0.52	-132.13	11.94
21	0.75	97.82	6.61	2.14	-25.52	0.05	-43.80	0.53	-137.49	11.61
22	0.75	90.09	6.24	2.05	-32.42	0.05	-46.17	0.53	-142.61	11.28
23	0.75	82.38	5.88	1.97	-39.51	0.05	-48.45	0.53	-148.08	10.95
24	0.76	74.56	5.55	1.89	-46.30	0.05	-50.37	0.53	-153.35	10.73
25	0.77	67.45	5.20	1.82	-53.32	0.04	-52.43	0.53	-159.71	10.48
26	0.77	59.93	4.83	1.74	-60.23	0.05	-55.25	0.53	-165.19	10.18

Typical Noise Parameters

Freq GHz	Fmin dB	Γ opt Mag.	Γ opt Ang.	Rn/50	Ga dB
2	0.14	0.78	16.40	0.20	20.28
3	0.22	0.697	23.2	0.19	18.95
4	0.3	0.625	30.7	0.19	17.71
5	0.37	0.558	38.9	0.18	16.58
6	0.45	0.498	47.7	0.17	15.55
7	0.53	0.443	57.3	0.16	14.63
8	0.6	0.395	67.5	0.15	13.81
9	0.68	0.352	78.4	0.14	13.09
10	0.75	0.316	89.9	0.13	12.47
11	0.83	0.286	102.1	0.12	11.96
12	0.91	0.261	115	0.11	11.55
13	0.98	0.243	128.6	0.1	11.24
14	1.06	0.231	142.9	0.1	11.03
15	1.14	0.224	157.8	0.09	10.93
16	1.21	0.224	173.4	0.09	10.94
17	1.29	0.23	-170.3	0.09	11.04

Note:

1. S-parameters are measured in 50 Ohm test environment.

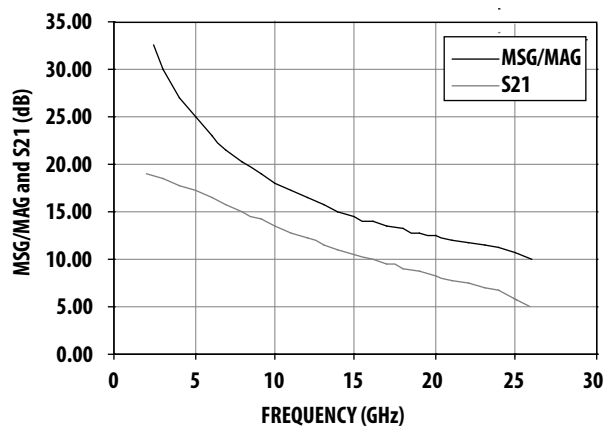

Figure 18. MSG/MAG and S21 vs Frequency at 4V 20mA

Small Signal Model Parameters

Parameter	Value	Parameter	Value	Parameter	Value	Parameter	Value
Vd (V)	1.5	Vd (V)	1.5	Vd (V)	1.5	Vd (V)	1.5
Id (mA)	5	Id (mA)	10	Id (mA)	15	Id (mA)	20
Gm	0.07549	Gm	0.10852	Gm	0.1276	Gm	0.128
Tau	0.001914	Tau	0.00212	tau	0.002061	tau	0.001952
Cgs	0.3008	Cgs	0.3596	Cgs	0.393	Cgs	0.3943
Rgs	0	Rgs	0.05267	Rgs	1.682	Rgs	1.989
Cgd	0.04174	Cgd	0.0376	Cgd	0.0337	Cgd	0.03377
Cds	0.1093	Cds	0.10984	Cds	0.109	Cds	0.1082
Rds	540.40	Rds	374.20	Rds	348.00	Rds	341.90

Parameter	Value	Parameter	Value	Parameter	Value	Parameter	Value
Vd (V)	2	Vd (V)	2	Vd (V)	2	Vd (V)	2
Id (mA)	5	Id (mA)	10	Id (mA)	15	Id (mA)	20
Gm	0.07357	Gm	0.1063	Gm	0.1243	Gm	0.1357
Tau	0.00206	Tau	0.00206	tau	0.002	tau	0.002034
Cgs	0.3266	Cgs	0.3973	Cgs	0.4458	Cgs	0.4758
Rgs	0.4454	Rgs	1.598	Rgs	1.9394	Rgs	2.282
Cgd	0.03642	Cgd	0.0323	Cgd	0.0289	Cgd	0.0256
Cds	0.1081	Cds	0.1075	Cds	0.1075	Cds	0.1072
Rds	631.10	Rds	444.90	Rds	408.90	Rds	418.70

Parameter	Value	Parameter	Value	Parameter	Value	Parameter	Value
Vd (V)	3	Vd (V)	3	Vd (V)	3	Vd (V)	3
Id (mA)	5	Id (mA)	10	Id (mA)	15	Id (mA)	20
Gm	0.0718	Gm	0.1023	Gm	0.1196	Gm	0.1305
tau	0.002319	tau	0.00224	tau	0.00226	tau	0.002248
Cgs	0.3761	Cgs	0.4662	Cgs	0.5227	Cgs	0.555
Rgs	1.106	Rgs	1.801	Rgs	2.023	Rgs	2.15
Cgd	0.0293	Cgd	0.02623	Cgd	0.02397	Cgd	0.022
Cds	0.1071	Cds	0.1065	Cds	0.1067	Cds	0.1064
Rds	785.70	Rds	556.80	Rds	494.10	Rds	479.90

Parameter	Value	Parameter	Value	Parameter	Value	Parameter	Value
Vd (V)	3	Vd (V)	3	Vd (V)	3	Vd (V)	3
Id (mA)	5	Id (mA)	10	Id (mA)	15	Id (mA)	20
Gm	0.06983	Gm	0.1005	Gm	0.5649	Gm	0.1269
tau	0.002544	tau	0.002389	tau	0.002383	tau	0.002368
Cgs	0.4077	Cgs	0.51068	Cgs	0.5649	Cgs	0.595
Rgs	1.341	Rgs	1.879	Rgs	1.912	Rgs	1.883
Cgd	0.02604	Cgd	0.02355	Cgd	0.02197	Cgd	0.0208
Cds	0.1062	Cds	0.10589	Cds	0.1057	Cds	0.1058
Rds	887.00	Rds	627.00	Rds	552.20	Rds	517.10

S Parameter Measurements

The S-parameters are measured on a .016 inch thick RO4003 printed circuit test board, using G-S-G (ground signal ground) probes. Coplanar waveguide is used to provide a smooth transition from the probes to the device under test. The presence of the ground plane on top of the test board results in excellent grounding at the device under test. A combination of SOLT (Short - Open - Load - Thru) and TRL (Thru - Reflect - Line) calibration techniques are used to correct for the effects of the test board, resulting in accurate device S-parameters. The reference plane for the S Parameters is at the edge of the package.

VMMK-1225 ADS Model

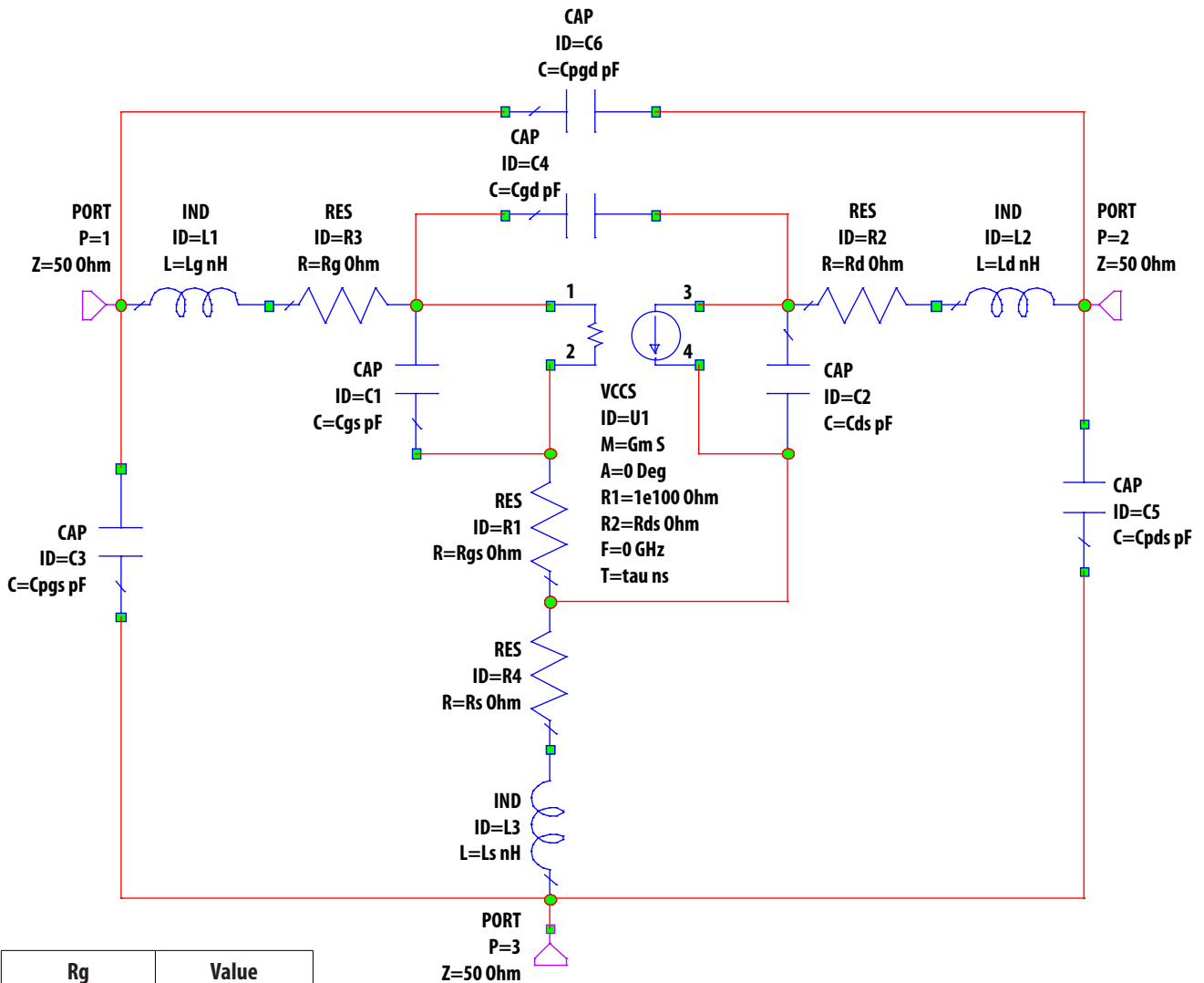

Component	Value
Rg	4.532
Rd	1.9
RsG	1.72
C pgs	0.0475
C pds	0.0392
C pgd	0.003935
Ls	0.000303
Lg	0.3492
Ld	0.2772

Part Number Ordering Information

Part Number	No. of Devices	Container
VMMK-1225-BLKG	100	antistatic bag
VMMK-1225-TR1G	5000	7" Reel

Package Dimension Outline

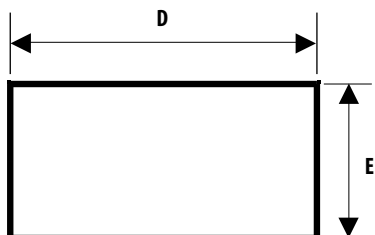

Symbol	Min (mm)	Max (mm)
D	1.004	1.085
E	0.500	0.585
A	0.225	0.275



Notes:
All dimensions are in mm

Device Orientation

REEL

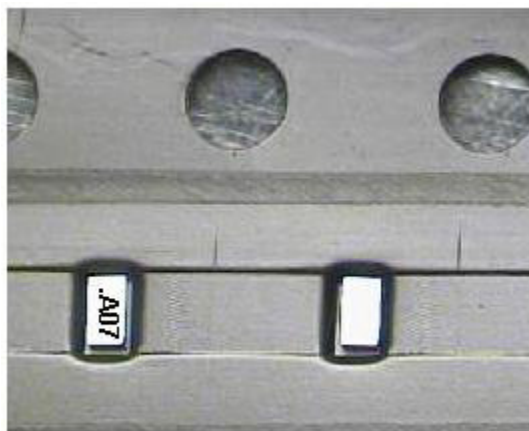
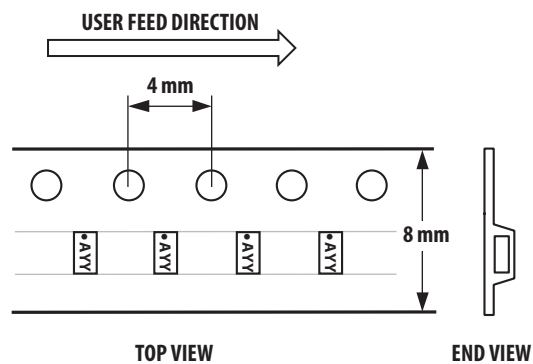
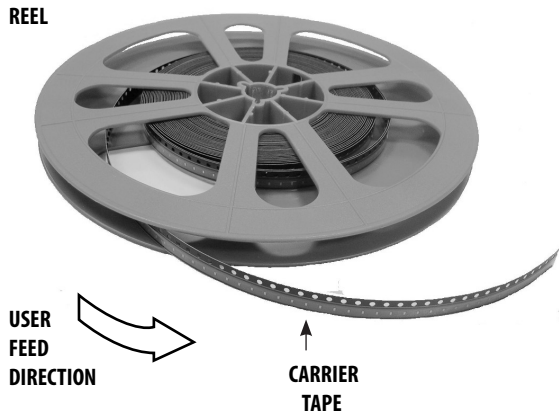

Notes:
"A" = Device Code
"YY" = Month Code

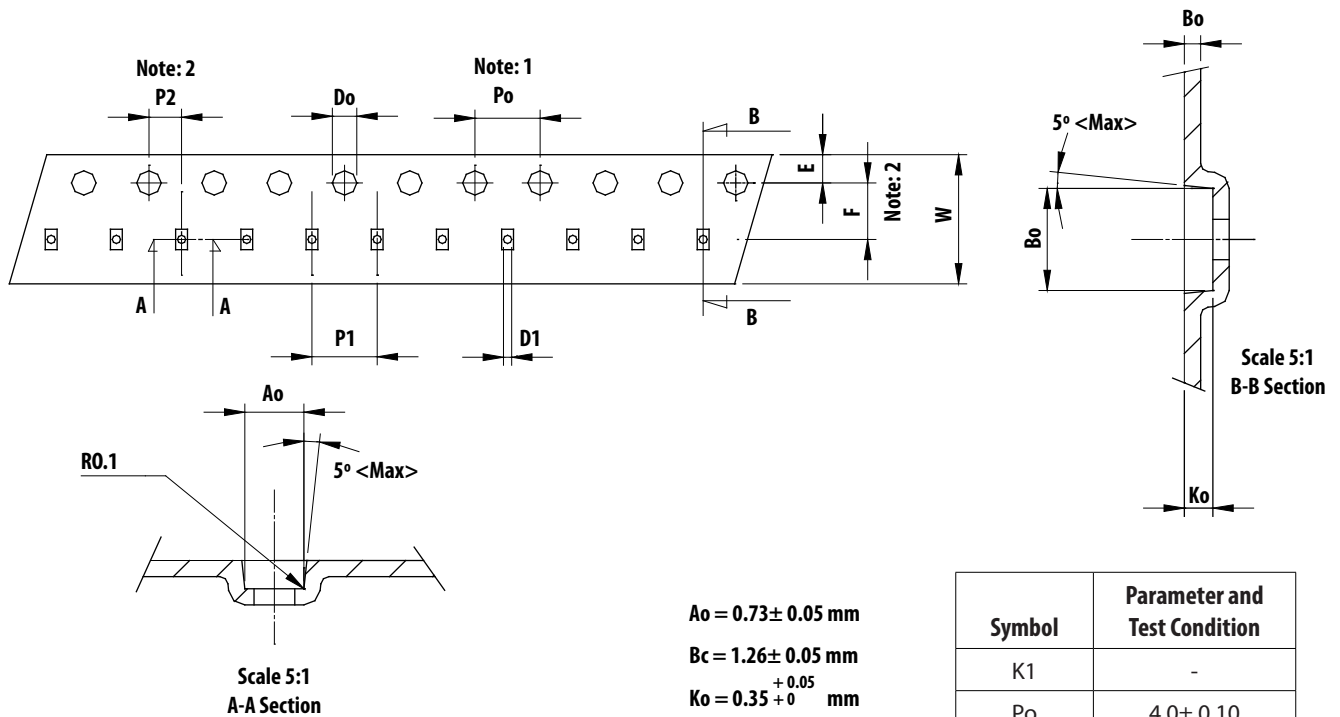

Notice:

1. 10 sprocket hole pitch cumulative tolerance is ± 0.1 mm
2. Pocket position relative to sprocket hole measured as true position of pocket not pocket hole
3. A_o & B_o measured on a plane 0.3mm above the bottom of the pocket to top surface of the carrier
4. K_o measured from a plane on the inside bottom of the pocket to the top surface of the carrier
5. Carrier camber shall be not than 1mm per 100mm through a length of 250mm

Symbol	Parameter and Test Condition
K1	-
Po	4.0 ± 0.10
P1	4.0 ± 0.10
P2	2.0 ± 0.05
Do	1.55 ± 0.05
D1	0.5 ± 0.05
E	1.75 ± 0.10
F	3.50 ± 0.05
Po	40.0 ± 0.10
W	8.0 ± 0.20
T	0.20 ± 0.02

Unit: mm

For product information and a complete list of distributors, please go to our web site: www.avagotech.com

Avago, Avago Technologies, and the A logo are trademarks of Avago Technologies Limited in the United States and other countries. Data subject to change. Copyright © 2005-2014 Avago Technologies Limited. All rights reserved. AV02-1082EN - January 9, 2014

AVAGO
TECHNOLOGIES