

# Xinger®

## Ultra Low Profile 0805 Balun 50Ω to 100Ω Balanced

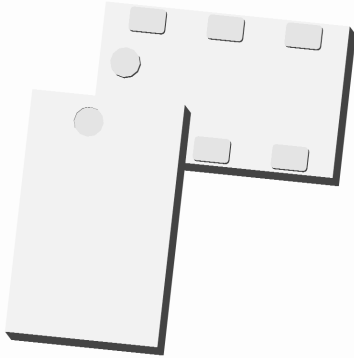

### Description

The B0430J50100AHF is a low cost, low profile sub-miniature unbalanced to balanced transformer designed specifically for differential inputs and output locations on next generation A to D and D to A Converter IC's in an easy to use surface mount package, covering 400 MHz–3000 MHz. The B0430J50100AHF is ideal for high volume manufacturing and delivers higher performance than traditional wire wound baluns. The B0430J50100AHF has an unbalanced port impedance of 50Ω and a 100Ω balanced port impedance. This transformation enables single ended signals to be applied to differential ports. The output ports have equal amplitude (-3dB) with 180 degree phase differential. The B0430J50100AHF is available on tape and reel for pick and place high volume manufacturing. Note that for optimal performance, the B0430J50100AHF should be used with a 10 pF series capacitor on the unbalanced port as shown in p. 2 & 3.

### Detailed Electrical Specifications: Specifications subject to change without notice.

Features:	Parameter	ROOM (25°C)			ROOM (25°C)			Unit
		Min.	Typ.	Max	Min.	Typ.	Max	
<ul style="list-style-type: none"> <li>• 400 – 3000 MHz</li> <li>• 0.7mm Height Profile</li> <li>• 50 Ohm to 2 x 50 Ohm</li> <li>• Low Insertion Loss</li> <li>• Designed for A-D and D-A Converters</li> <li>• Surface Mountable</li> <li>• Tape &amp; Reel</li> <li>• Non-conductive Surface</li> <li>• RoHS Compliant</li> <li>• Halogen Free</li> </ul>	Frequency	400		2500	2501		3000	MHz
	Unbalanced Port Impedance		50			50		Ω
	Balanced Port Impedance		100			100		Ω
	Return Loss	8.4	10.3		7	7.3		dB
	Insertion Loss*		1.7	3.0		2.6	4.0	dB
	Amplitude Balance		0.7	1.4		0.7	1.4	dB
	Phase Balance		7	12		7	12	Degrees
	CMRR		25			25		dB
	Power Handling @85C			0.4			0.4	Watts
	Operating Temperature		-55		+105	-55		+105

\* Insertion Loss stated at room temperature (Insertion Loss is approximately 0.1 dB higher at +85 °C)

### Outline Drawing

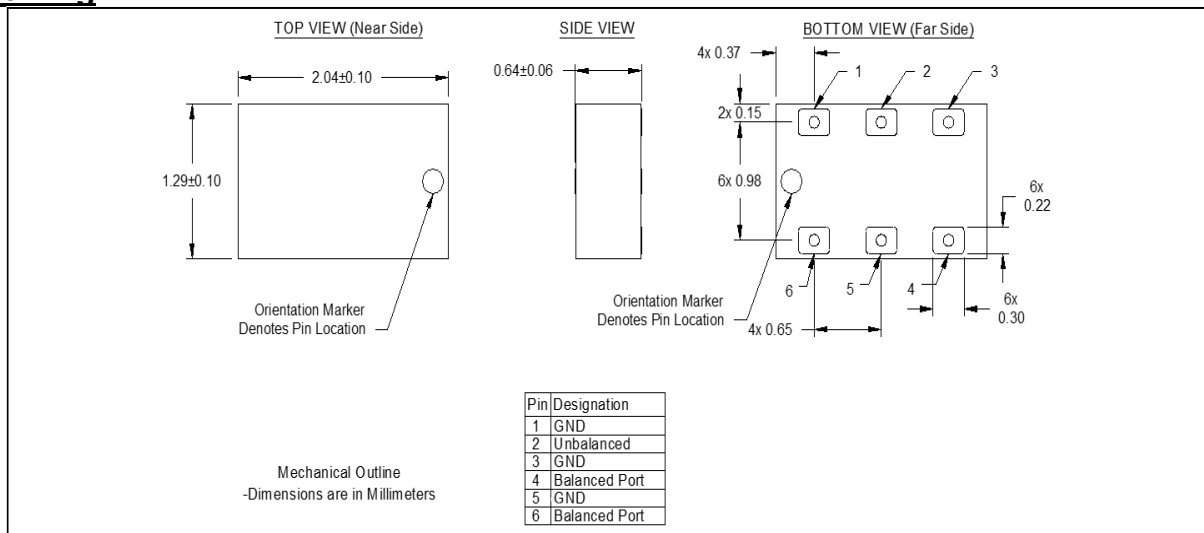

## Typical Performance: 300 MHz. to 3100 MHz. with an external 10 pF capacitor on pin 2

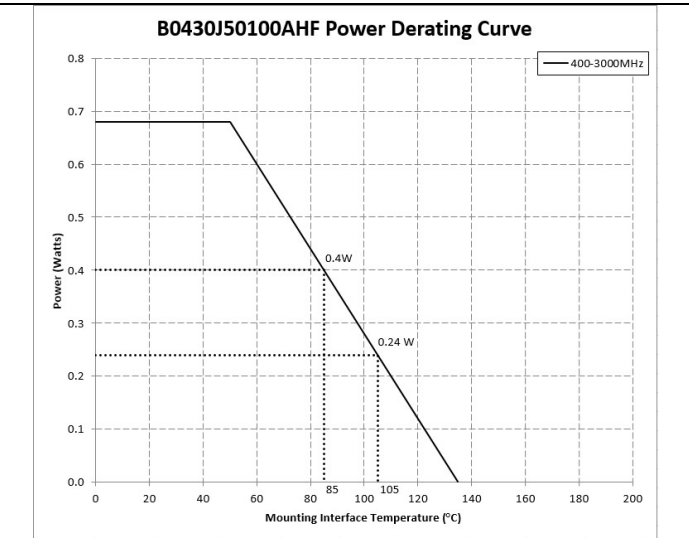
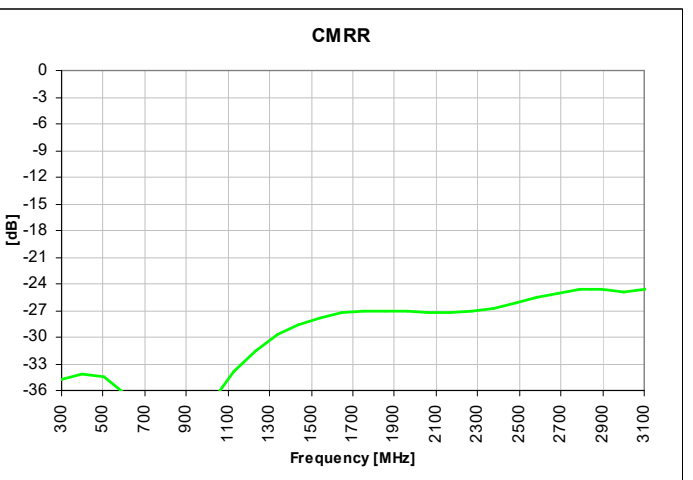
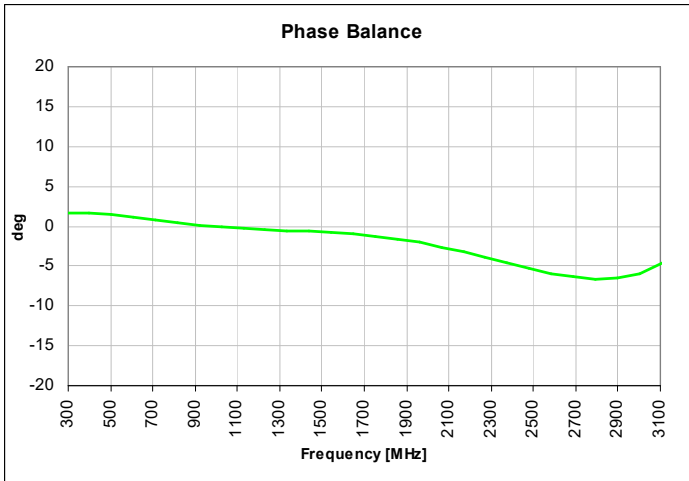
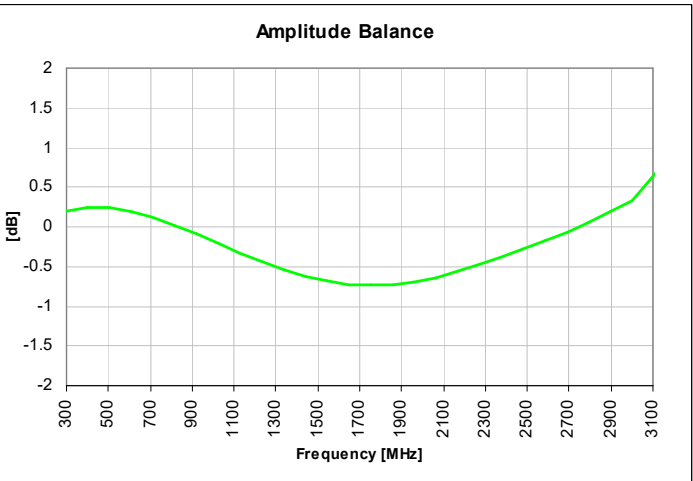
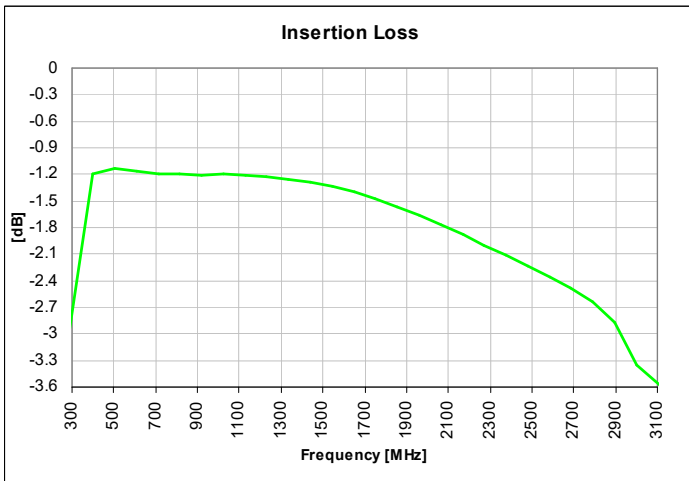
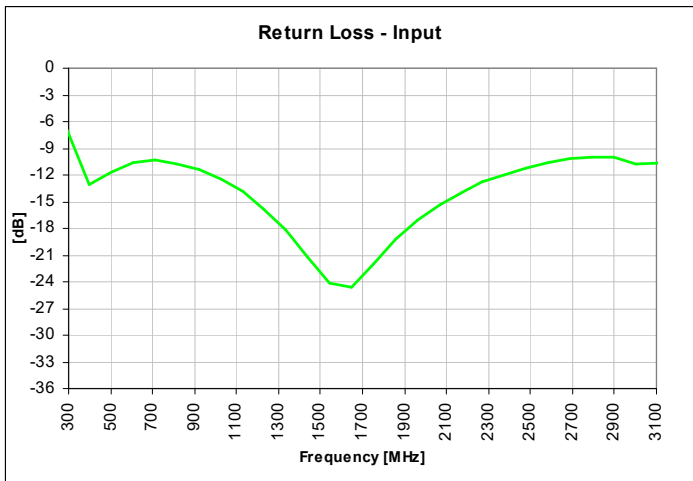

### Mounting Configuration:

In order for Xinger surface mount components to work optimally, the proper impedance transmission lines must be used to connect to the RF ports. If this condition is not satisfied, insertion loss, Isolation and VSWR may not meet published specifications.

All of the Xinger components are constructed from organic PTFE based composites which possess excellent electrical and mechanical stability. Xinger components are compliant to a variety of ROHS and Green standards and ready for Pb-free soldering processes. Pads are Gold plated with a Nickel barrier.

This component requires a 10 pF capacitor to be mounted in front of the unbalanced port (Pin 2) of the balun as shown in the drawing below for optimum performance. The capacitor should be placed as close as possible to the balun to minimize transmission line effects as shown in the suggested PCB footprint below.

An example of the PCB footprint used in the testing of these parts is shown below. In specific designs, the transmission line widths need to be adjusted to the unique dielectric coefficients and thicknesses as well as varying pick and place equipment tolerances.

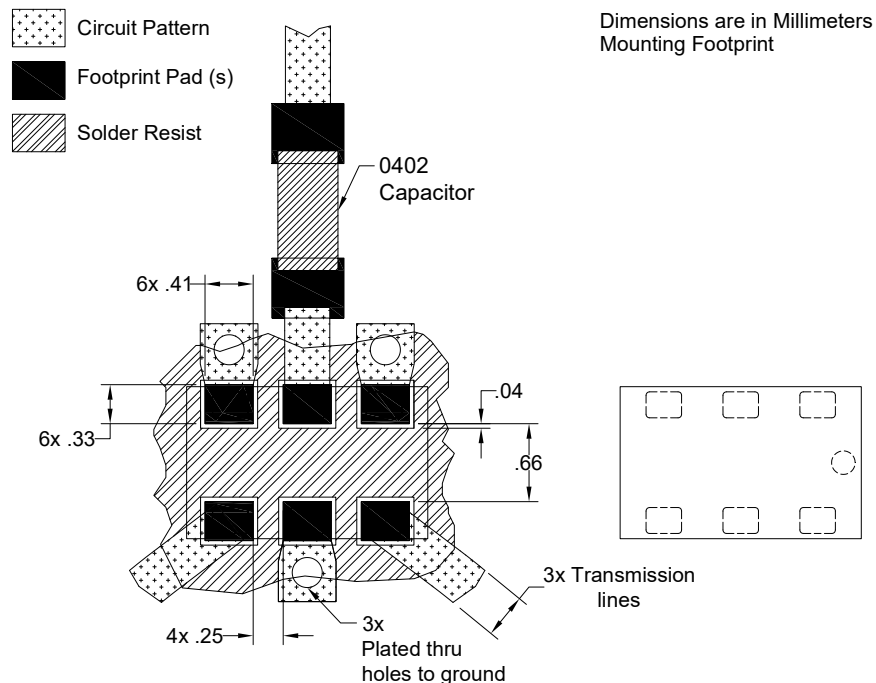

## Packaging and Ordering Information

Parts are available in reel and are packaged per EIA 481-D. Parts are oriented in tape and reel as shown below. Minimum order quantities are 4000 per reel.

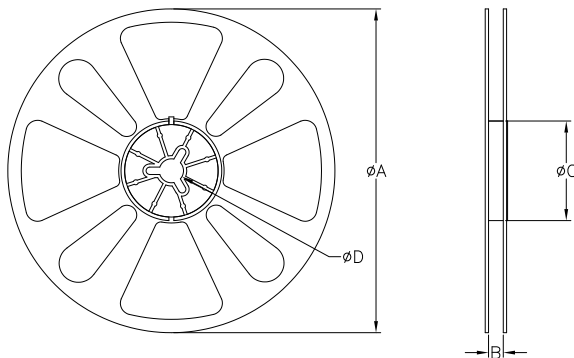
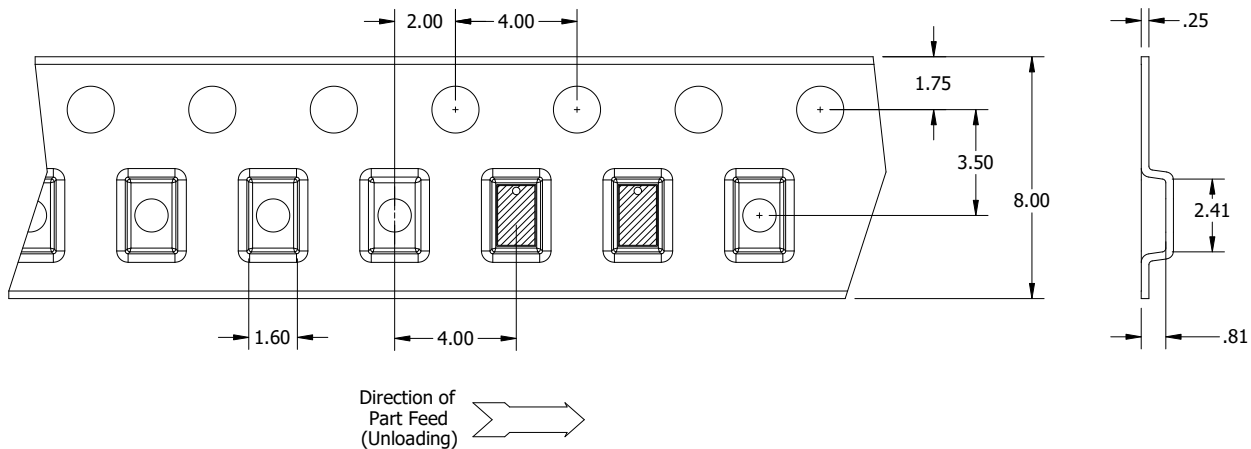

TABLE 1		
QUANTITY/REEL	REEL DIMENSIONS mm	
4000	$\phi A$	177.80
	B	8.00
	$\phi C$	50.80
	$\phi D$	13.00