

**SERIES:** CP60H | **DESCRIPTION:** PELTIER MODULE**FEATURES**

- arcTEC™ structure on select models
- enhanced reliability for high thermal cycling
- superior thermal performance
- silicon sealed
- wide  $\Delta T$  max
- low profile
- precise temperature control
- solid state construction



| MODEL                     | input voltage <sup>1</sup> | input current <sup>2</sup> | internal resistance <sup>3</sup> | output Qmax <sup>4</sup>     |                              | output $\Delta T$ max <sup>5</sup>            |   |
|---------------------------|----------------------------|----------------------------|----------------------------------|------------------------------|------------------------------|---|---|
|                           | max (Vdc)                  | max (A)                    | typ ( $\Omega \pm 10\%$ )        | $T_h = 27^\circ\text{C}$ (W) | $T_h = 50^\circ\text{C}$ (W) | $T_h = 27^\circ\text{C}$ ( $^\circ\text{C}$ ) | $T_h = 50^\circ\text{C}$ ( $^\circ\text{C}$ ) |
| CP60131H                  | 3.8                        | 6.0                        | 0.45                             | 13                           | 14.3                         | 70  | 77  |
| CP60139H                  | 2.1                        | 6.0                        | 0.30                             | 7.4                          | 8.2                          | 70  | 77  |
| CP60231H                  | 8.8                        | 6.0                        | 1.05                             | 29.7                         | 32.7                         | 70  | 77  |
| CP60239H                  | 3.8                        | 6.0                        | 0.55                             | 13.6                         | 14.9                         | 70  | 77  |
| CP602040395H <sup>6</sup> | 7.6                        | 6.0                        | 1.09                             | 27.5                         | 30.2                         | 70  | 77  |
| CP60301233H               | 5.6                        | 6.0                        | 0.76                             | 19.7                         | 21.7                         | 70  | 77  |
| CP60301531H               | 7.6                        | 6.0                        | 0.93                             | 26.3                         | 28.9                         | 70  | 77  |
| CP60302031H               | 13.0                       | 6.0                        | 1.51                             | 49.5                         | 54.5                         | 68  | 75  |
| CP603315H <sup>6</sup>    | 15.7                       | 6.0                        | 1.90                             | 53.1                         | 59.1                         | 70  | 77  |
| CP6030395 <sup>6</sup>    | 11.8                       | 6.0                        | 1.65                             | 41.5                         | 45.6                         | 70  | 77  |
| CP603395H <sup>6</sup>    | 8.8                        | 6.0                        | 1.25                             | 31.1                         | 34.2                         | 70  | 77  |
| CP604020395H <sup>6</sup> | 7.6                        | 6.0                        | 1.09                             | 27.5                         | 30.2                         | 70  | 77  |
| CP60433H <sup>6</sup>     | 19.5                       | 6.0                        | 2.54                             | 67.6                         | 74.3                         | 68  | 75  |
| CP604395H <sup>6</sup>    | 15.7                       | 6.0                        | 2.2                              | 55.6                         | 61.0                         | 70  | 77  |
| CP604040 <sup>6</sup>     | 24.1                       | 6.0                        | 3.21                             | 83.5                         | 91.9                         | 68  | 75  |
| CP60546241 <sup>6</sup>   | 41.3                       | 6.0                        | 5.78                             | 147                          | 161                          | 70  | 77  |
| CP6055354 <sup>6</sup>    | 35.4                       | 6.0                        | 4.95                             | 126                          | 138                          | 70  | 77  |
| CP60555542 <sup>6</sup>   | 29.8                       | 6.0                        | 4.15                             | 106                          | 116                          | 70  | 77  |
| CP604060395 <sup>6</sup>  | 23.6                       | 6.0                        | 3.3                              | 80.2                         | 88.2                         | 70  | 77  |

- Notes:
1. Maximum voltage at  $\Delta T$  max and  $T_h = 27^\circ\text{C}$
  2. Maximum current to achieve  $\Delta T$  max
  3. Measured by AC 4-terminal method at  $25^\circ\text{C}$
  4. Maximum heat absorbed at cold side occurs at  $I_{max}$ ,  $V_{max}$ , and  $\Delta T = 0^\circ\text{C}$
  5. Maximum temperature difference occurs at  $I_{max}$ ,  $V_{max}$ , and  $Q = 0\text{W}$  ( $\Delta T$  max measured in a vacuum at 1.3 Pa)
  6. Designed with arcTEC™ structure.

## SPECIFICATIONS

| parameter                  | conditions/description                  | min | typ | max | units |
|----------------------------|---|-----|-----|-----|-------|
| solder melting temperature | connection between thermoelectric pairs | 235 |     |     | °C    |
| assembly compression       |   |     |     | 1   | MPa   |
| RoHS                       | yes                                     |     |     |     |       |

## MECHANICAL DRAWING

units: mm

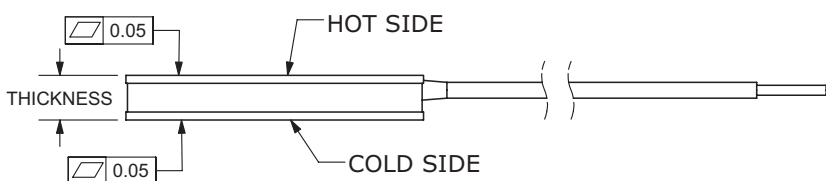

|   | MATERIAL  | PLATING |
|---|---|---------|
| ceramic plate   | 96% AL <sub>2</sub> O <sub>3</sub>                        |         |
| wire leads (CP60131H, CP60231H, CP60302031H, CP60301233H, CP60301531H, CP603315H) | 22 AWG  | tin     |
| wire leads (all other models)   | 20 AWG  | tin     |
| sealer  | silicon rubber 703 RTV (between cold and hot side plates) |         |
| joint cover   | silicon rubber 703 RTV                                    |         |
| marking   | P/N & S/N printed on cold side surface                    |         |

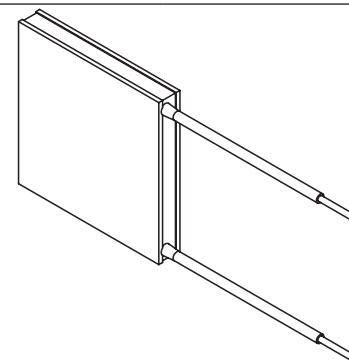
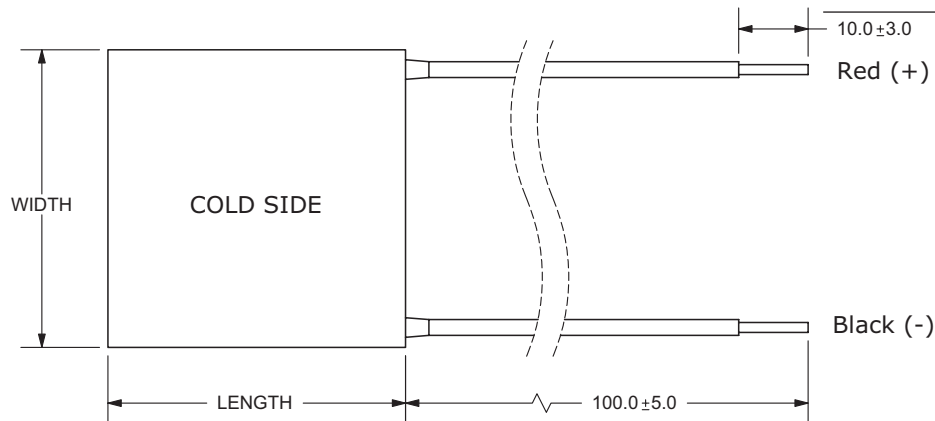

| MODEL NO.    | LENGTH (mm) | WIDTH (mm) | THICKNESS (mm) | MODEL NO.    | LENGTH (mm) | WIDTH (mm) | THICKNESS (mm) |
|--------------|-------------|------------|----------------|--------------|-------------|------------|----------------|
| CP60131H     | 15 ± 0.3    | 15 ± 0.3   | 3.1 ± 0.025    | CP603395H    | 30 ± 0.3    | 30 ± 0.3   | 3.95 ± 0.025   |
| CP60139H     | 15 ± 0.3    | 15 ± 0.3   | 3.9 ± 0.025    | CP604020395H | 40 ± 0.3    | 20 ± 0.3   | 3.95 ± 0.025   |
| CP60231H     | 20 ± 0.3    | 20 ± 0.3   | 3.1 ± 0.025    | CP60433H     | 40 ± 0.3    | 40 ± 0.3   | 3.3 ± 0.03     |
| CP60239H     | 20 ± 0.3    | 20 ± 0.3   | 3.9 ± 0.025    | CP604395H    | 40 ± 0.3    | 40 ± 0.3   | 3.95 ± 0.025   |
| CP602040395H | 20 ± 0.3    | 40 ± 0.3   | 3.95 ± 0.025   | CP604040     | 40 ± 0.3    | 40 ± 0.3   | 4.0 ± 0.1      |
| CP60301233H  | 30 ± 0.1    | 12 ± 0.1   | 3.3 ± 0.1      | CP60546241   | 62.5 ± 0.3  | 54 ± 0.3   | 4.1 ± 0.1      |
| CP60301531H  | 30 ± 0.3    | 15 ± 0.3   | 3.1 ± 0.025    | CP6055354    | 55 ± 0.3    | 55 ± 0.3   | 4.1 ± 0.1      |
| CP60302031H  | 30 ± 0.3    | 20 ± 0.3   | 3.1 ± 0.1      | CP6055542    | 55 ± 0.3    | 55 ± 0.3   | 4.2 ± 0.1      |
| CP603315H    | 30 ± 0.3    | 30 ± 0.3   | 3.15 ± 0.025   | CP604060395  | 40 ± 0.3    | 60 ± 0.3   | 3.95 ± 0.025   |
| CP6030395    | 30 ± 0.3    | 30 ± 0.3   | 3.95 ± 0.025   |              |             |            |                |

### CP60131H PERFORMANCE (Th=27°C)

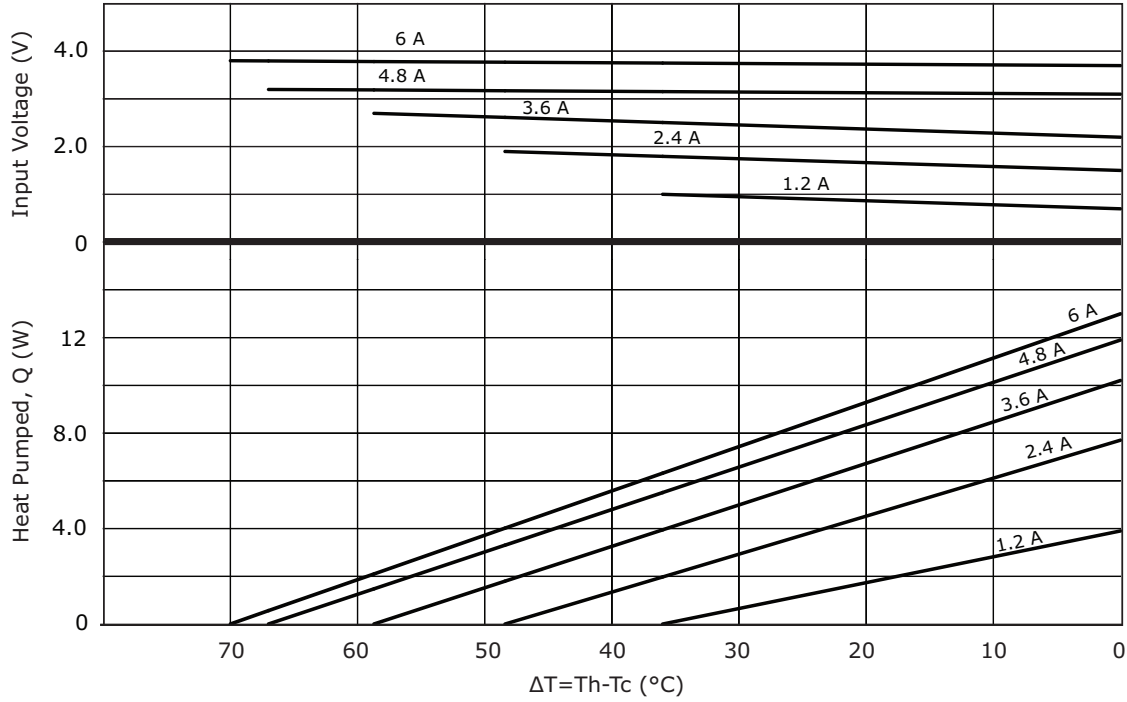

### CP60131H PERFORMANCE (Th=50°C)



### CP60139H PERFORMANCE (Th=27°C)

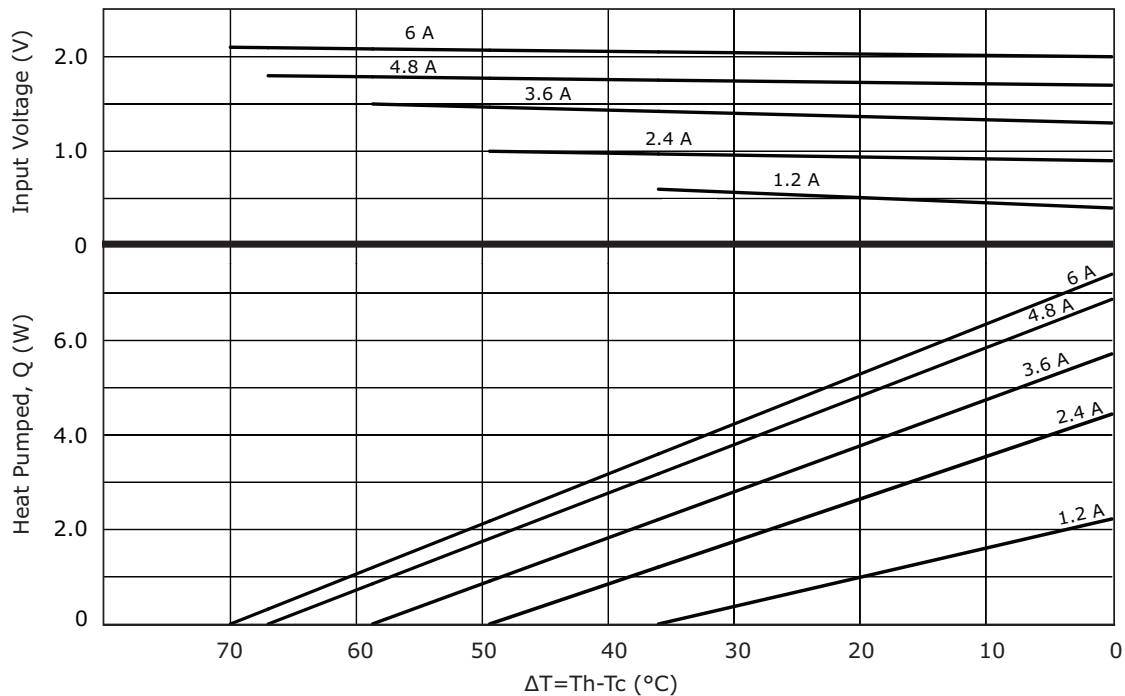

### CP60139H PERFORMANCE (Th=50°C)

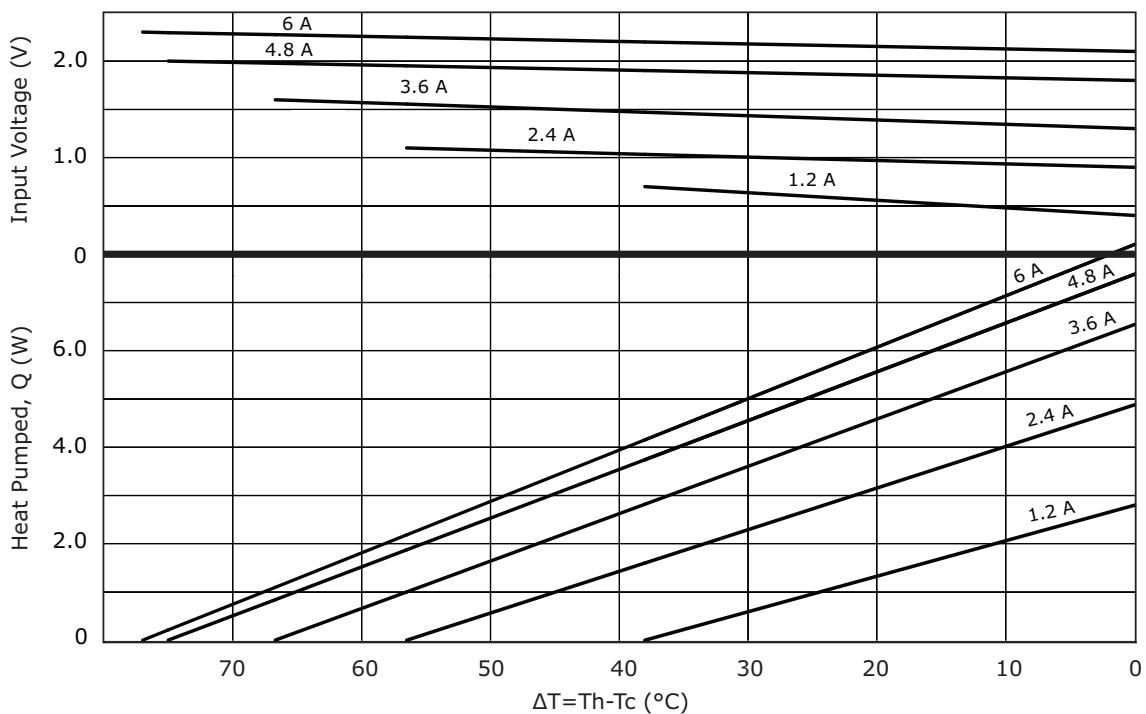

### CP60231H PERFORMANCE (Th=27°C)

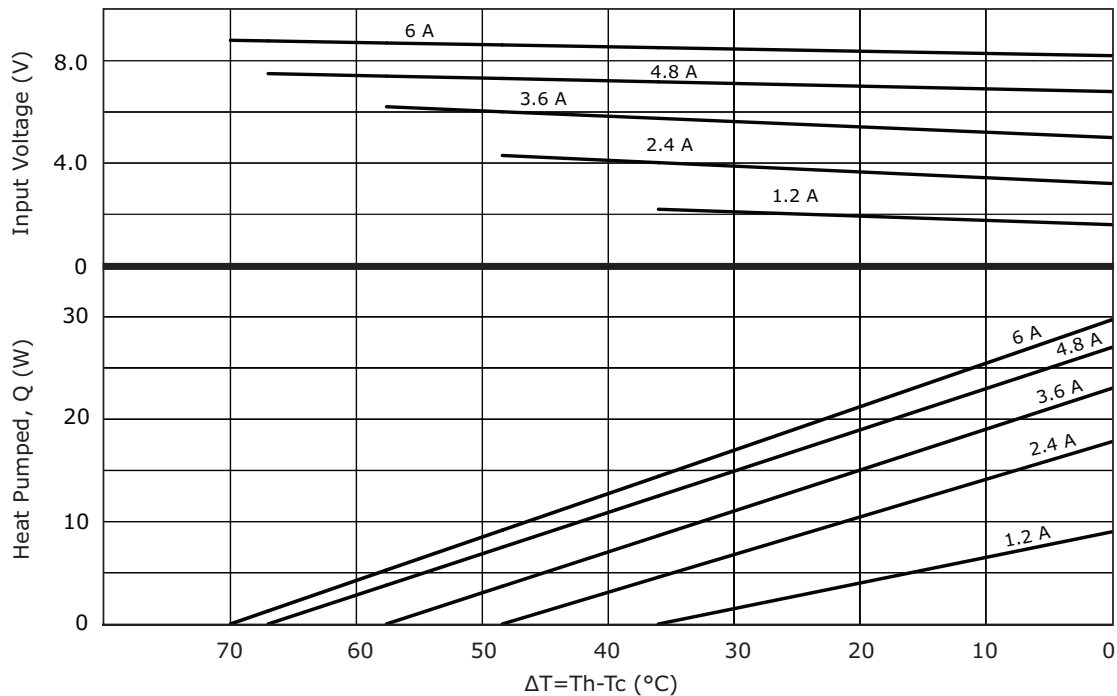

### CP60231H PERFORMANCE (Th=50°C)

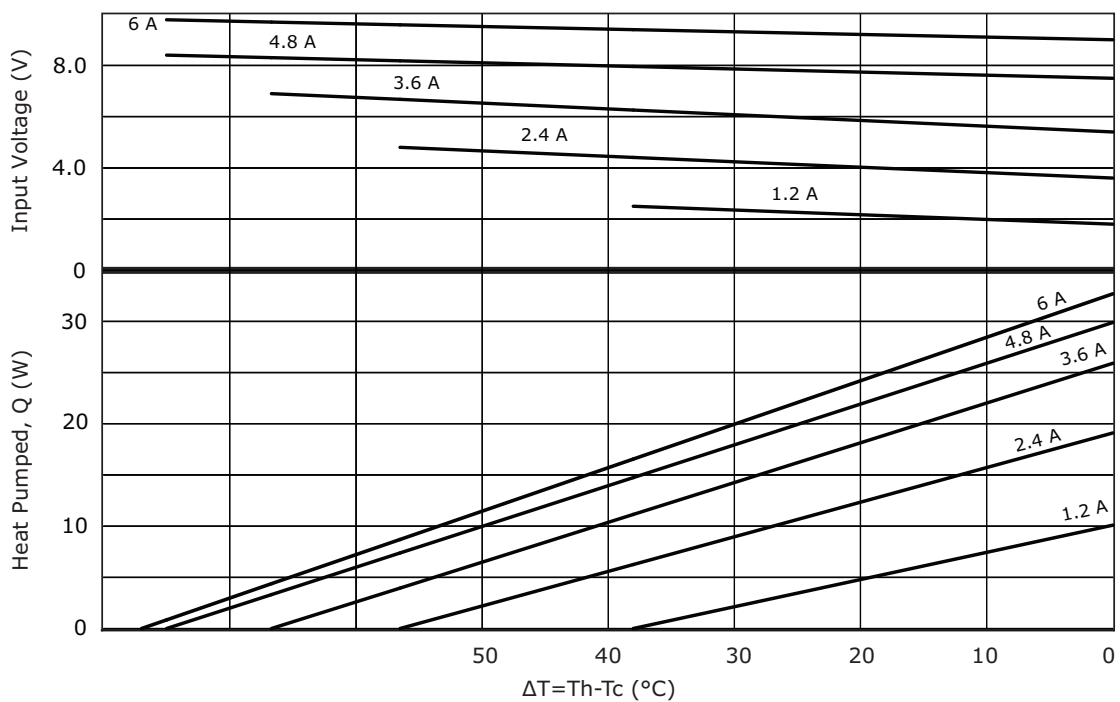

### CP60239H PERFORMANCE (Th=27°C)

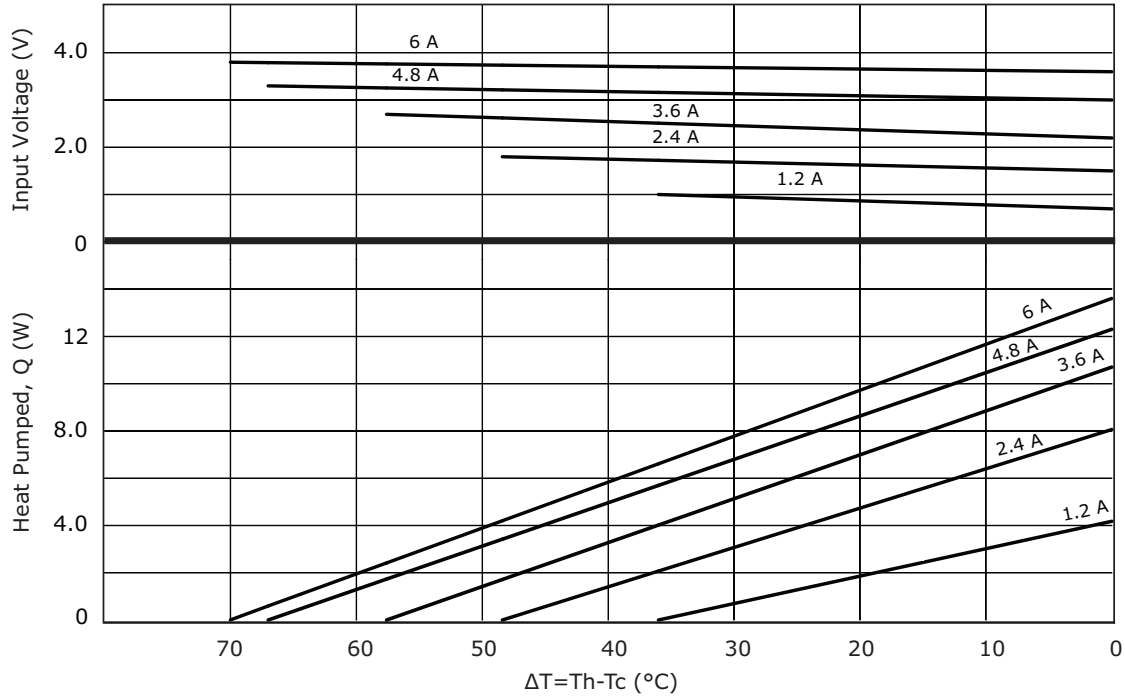

### CP60239H PERFORMANCE (Th=50°C)

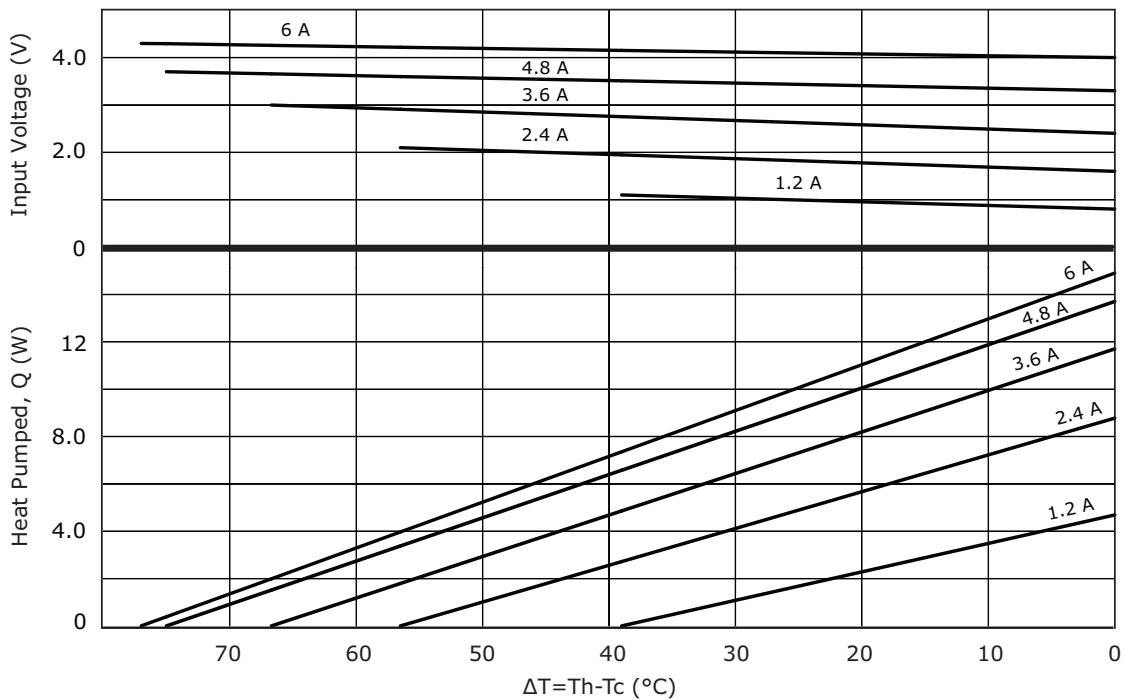

### CP602040395H PERFORMANCE (Th=27°C)



### CP602040395H PERFORMANCE (Th=50°C)

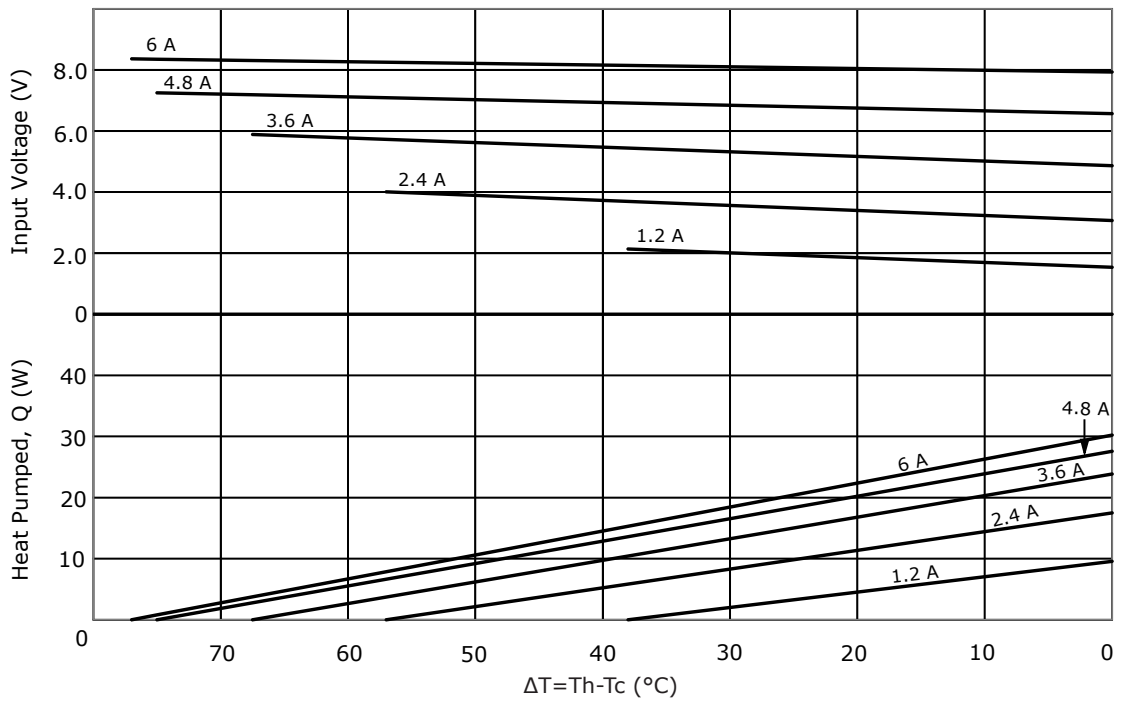

### CP60301233H PERFORMANCE (Th=27°C)

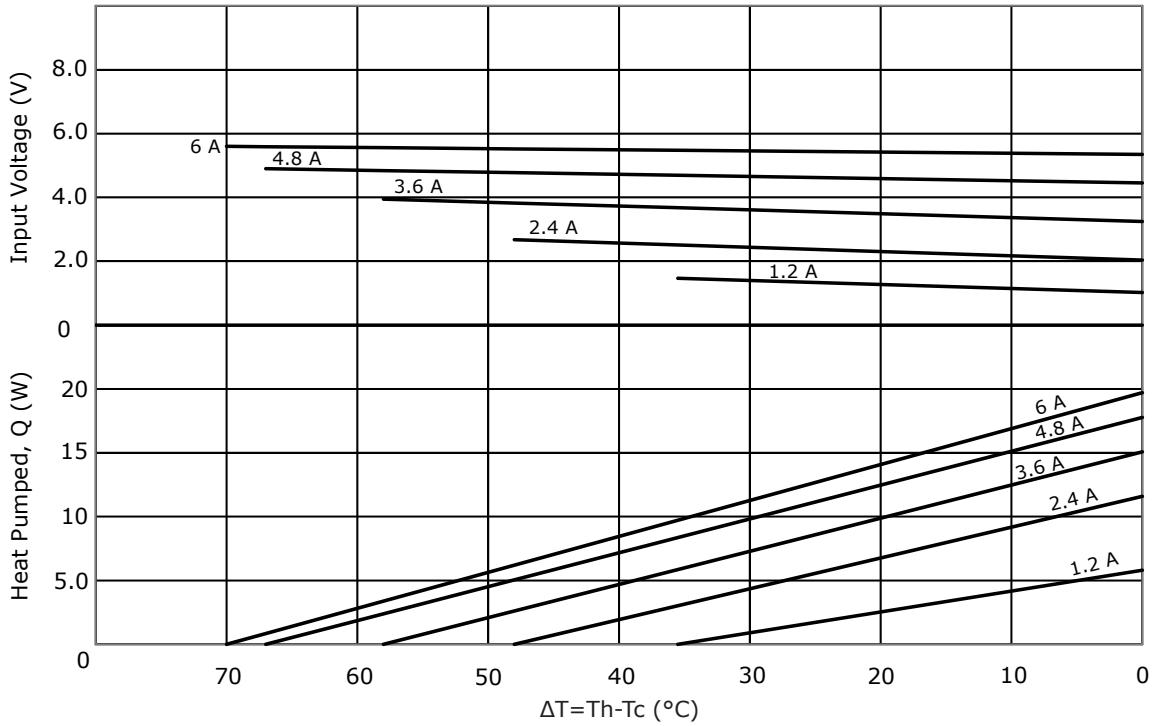

### CP60301233H PERFORMANCE (Th=50°C)

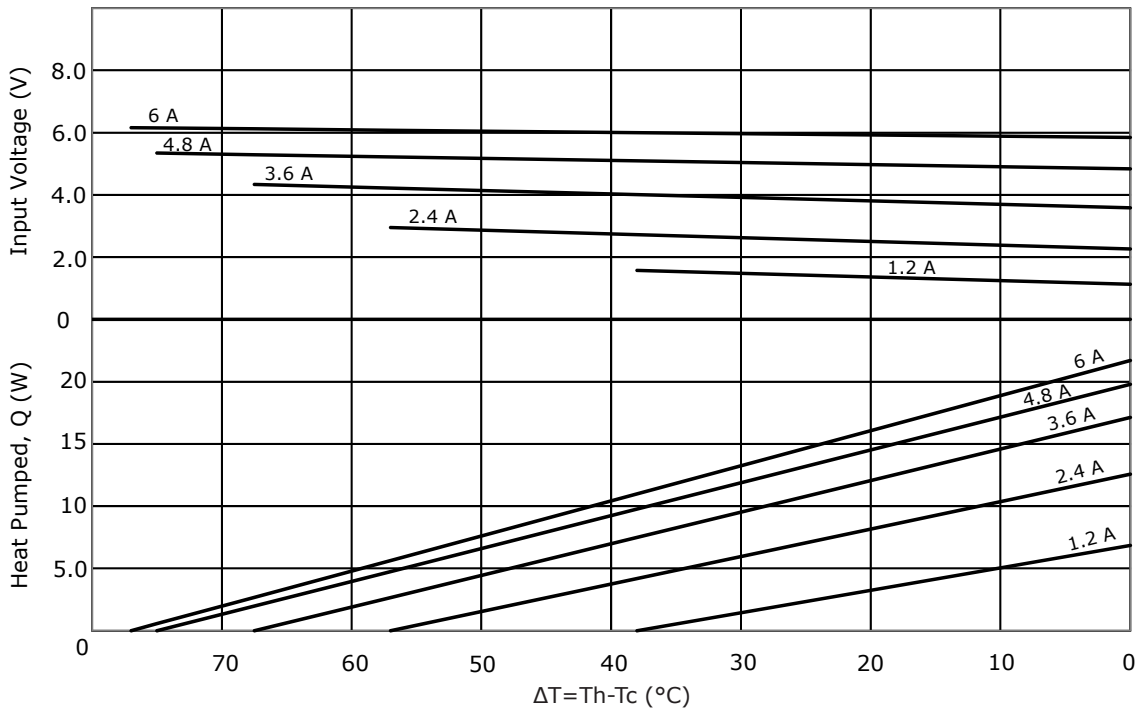



### CP60301531H PERFORMANCE (Th=27°C)

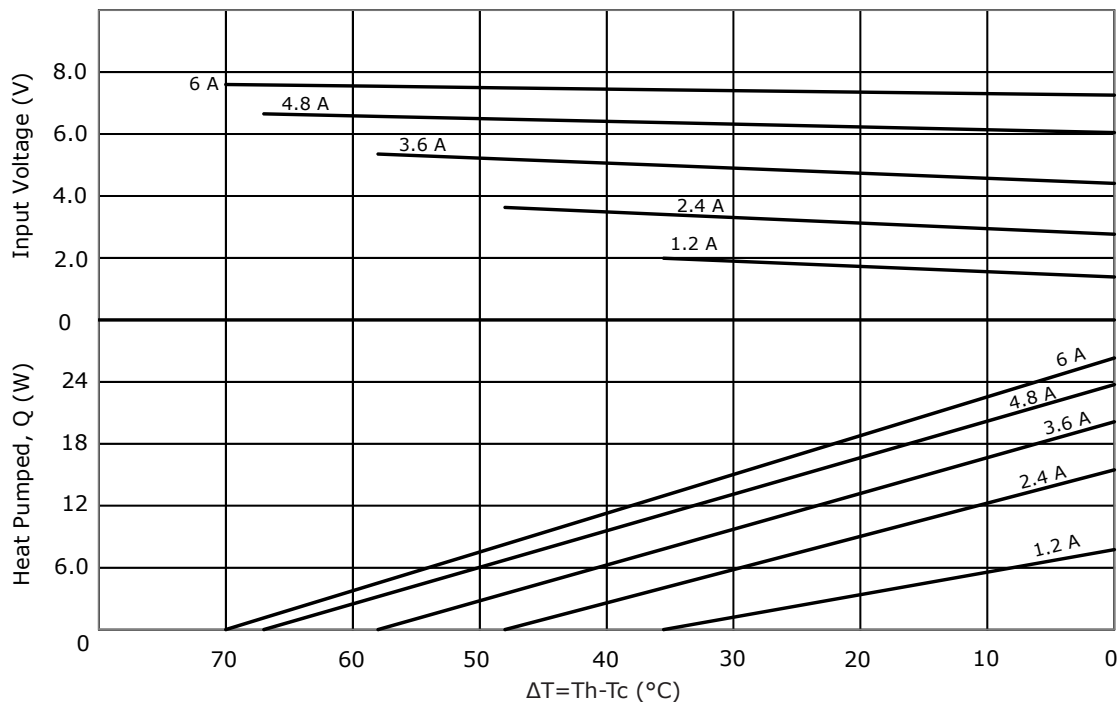

### CP60301531H PERFORMANCE (Th=50°C)



### CP60302031H PERFORMANCE (Th=27°C)

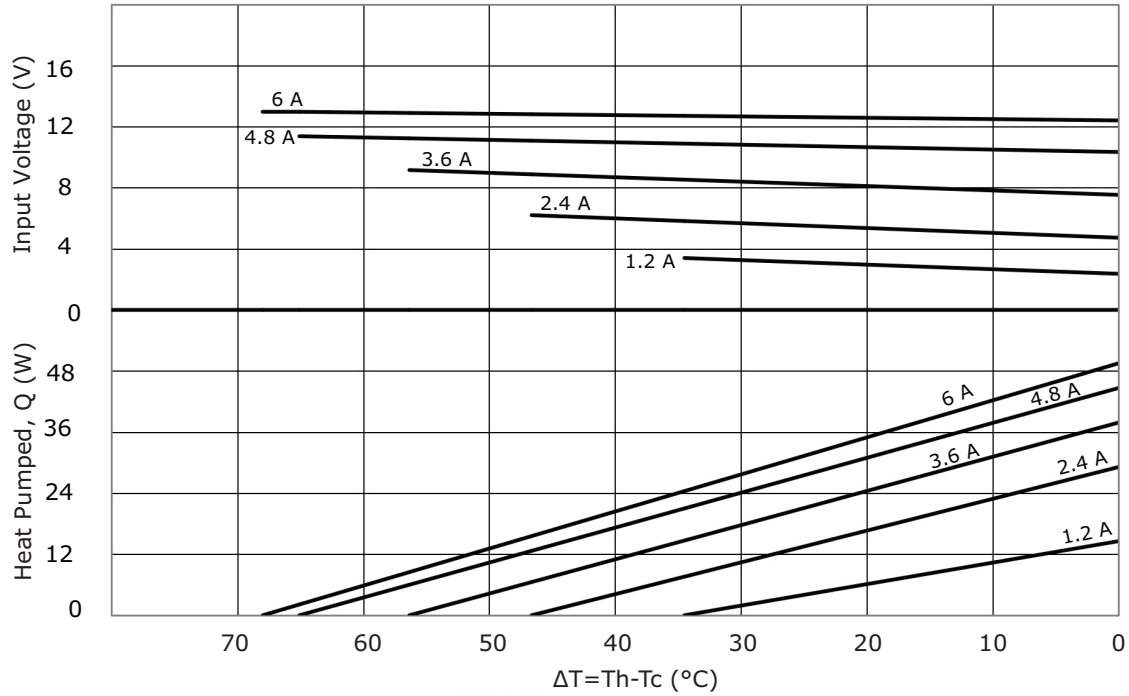

### CP60302031H PERFORMANCE (Th=50°C)

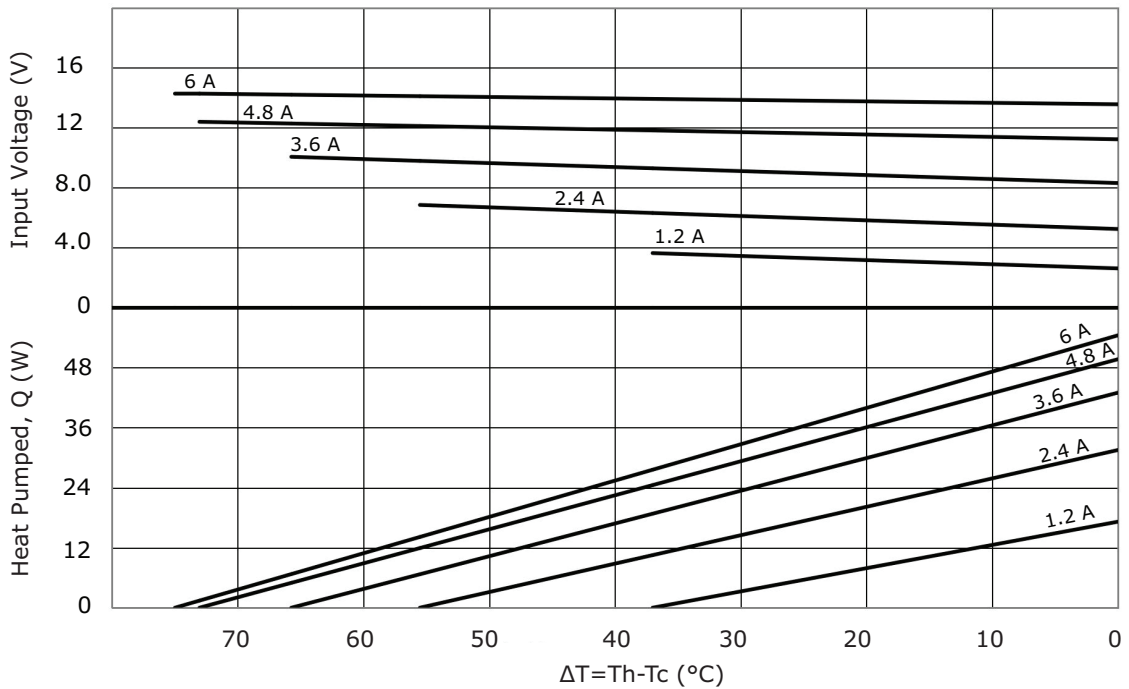

### CP603315H PERFORMANCE (Th=27°C)

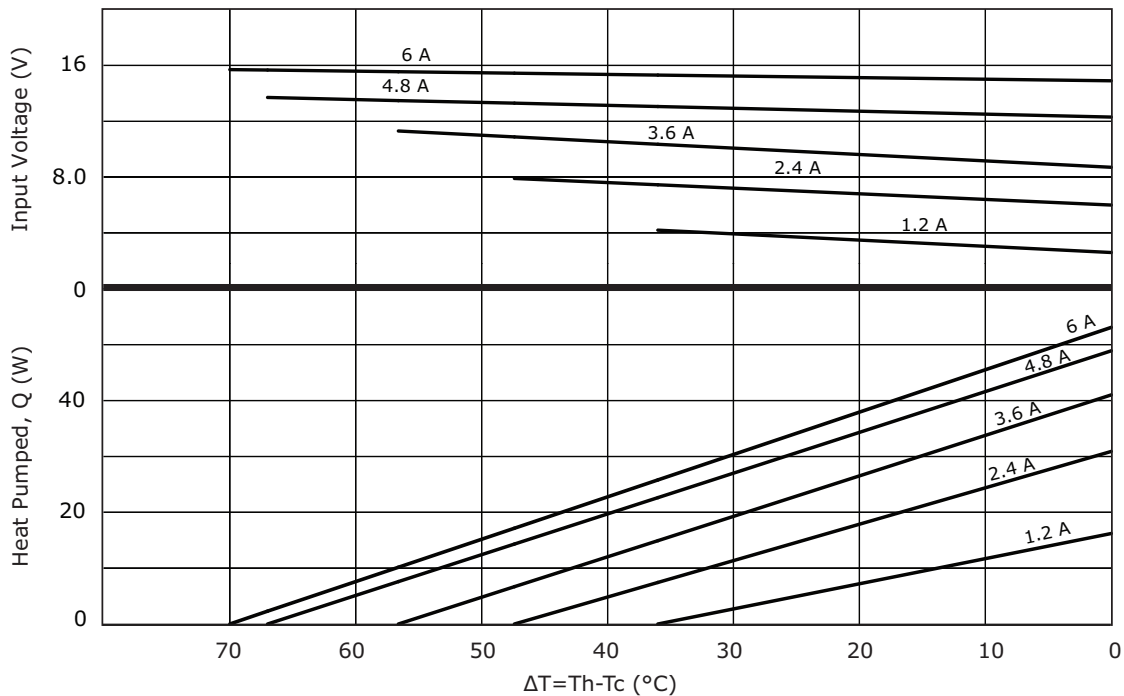

### CP603315H PERFORMANCE (Th=50°C)

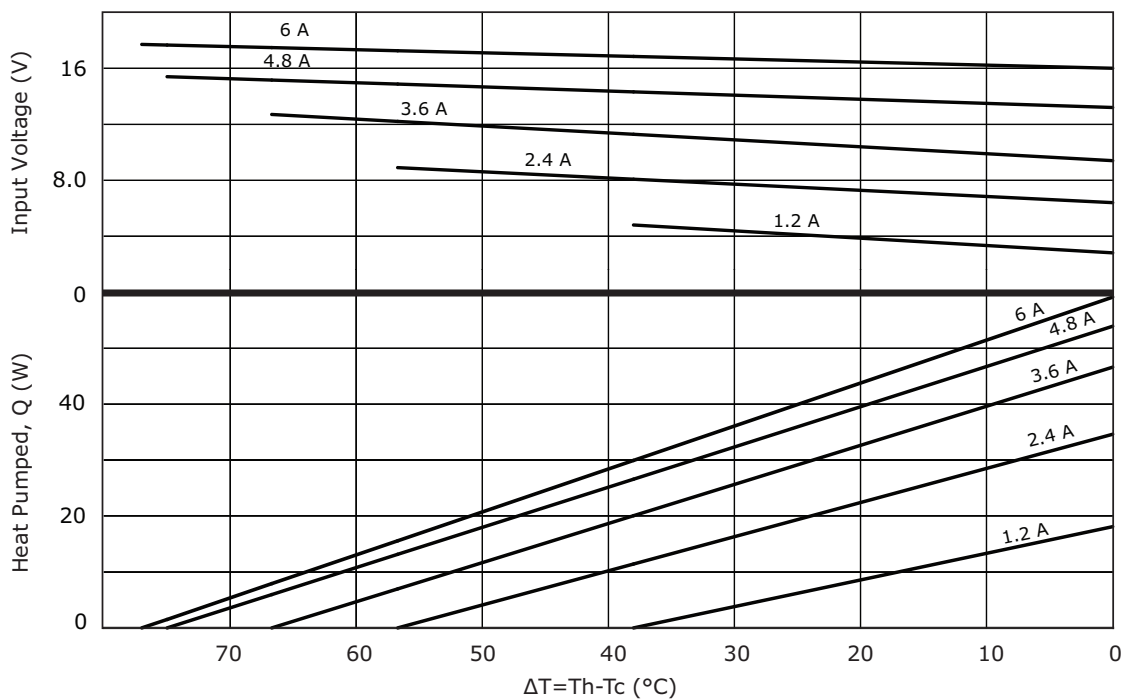

### CP6030395 PERFORMANCE (Th=27°C)

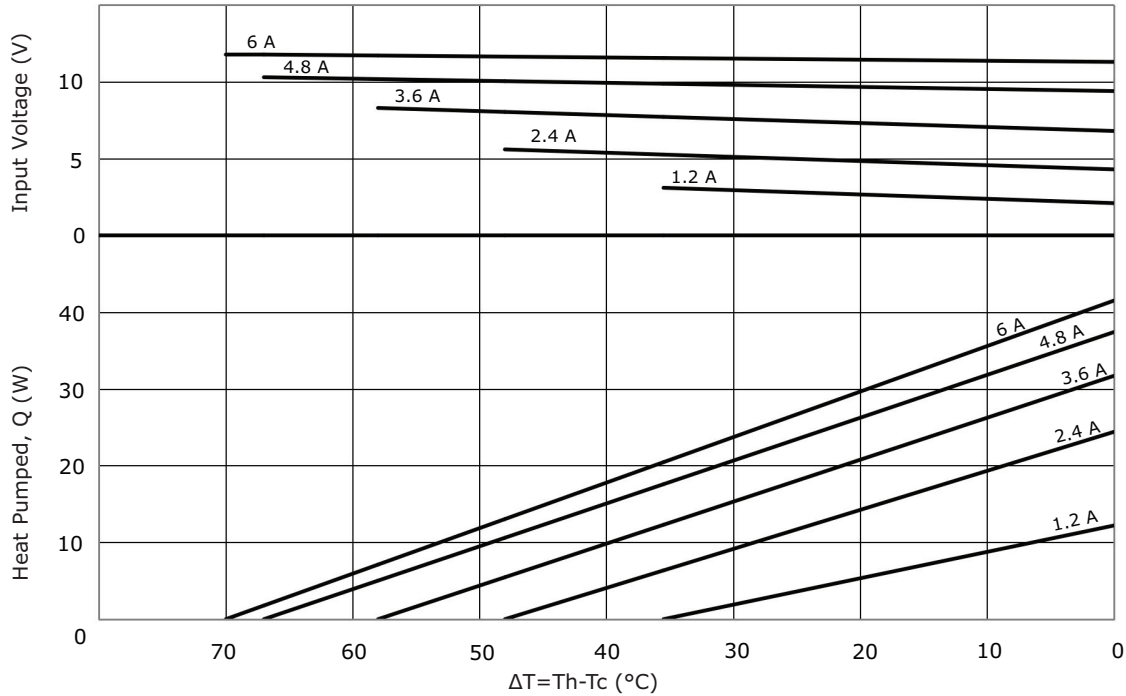

### CP6030395 PERFORMANCE (Th=50°C)

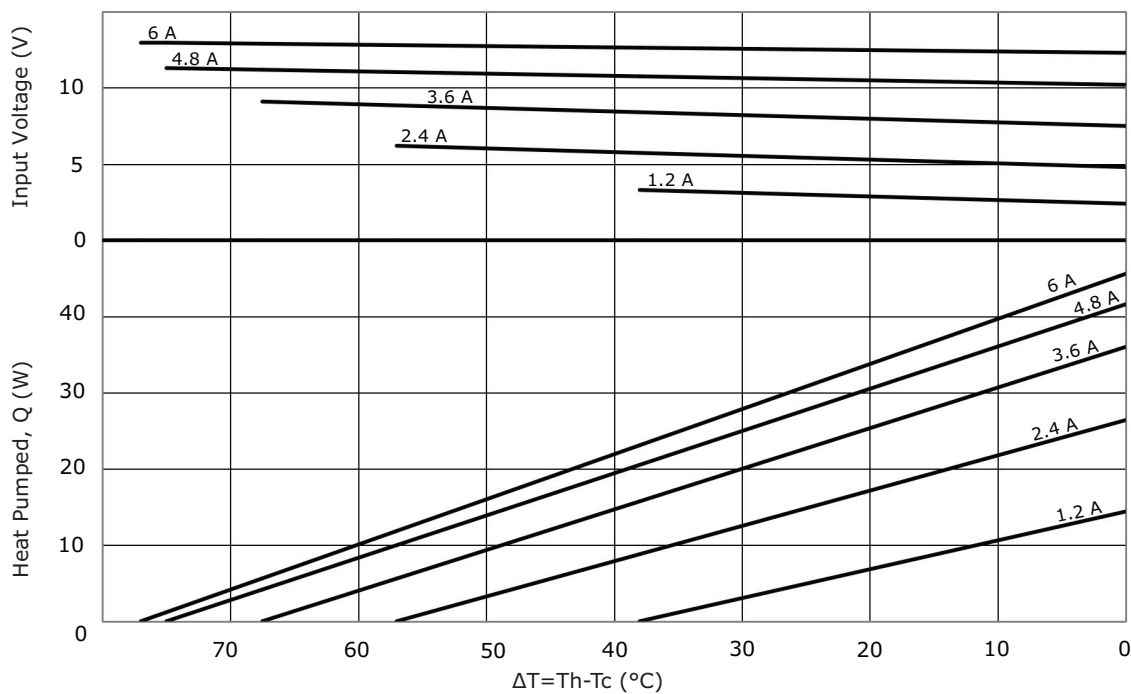

### CP603395H PERFORMANCE (Th=27°C)

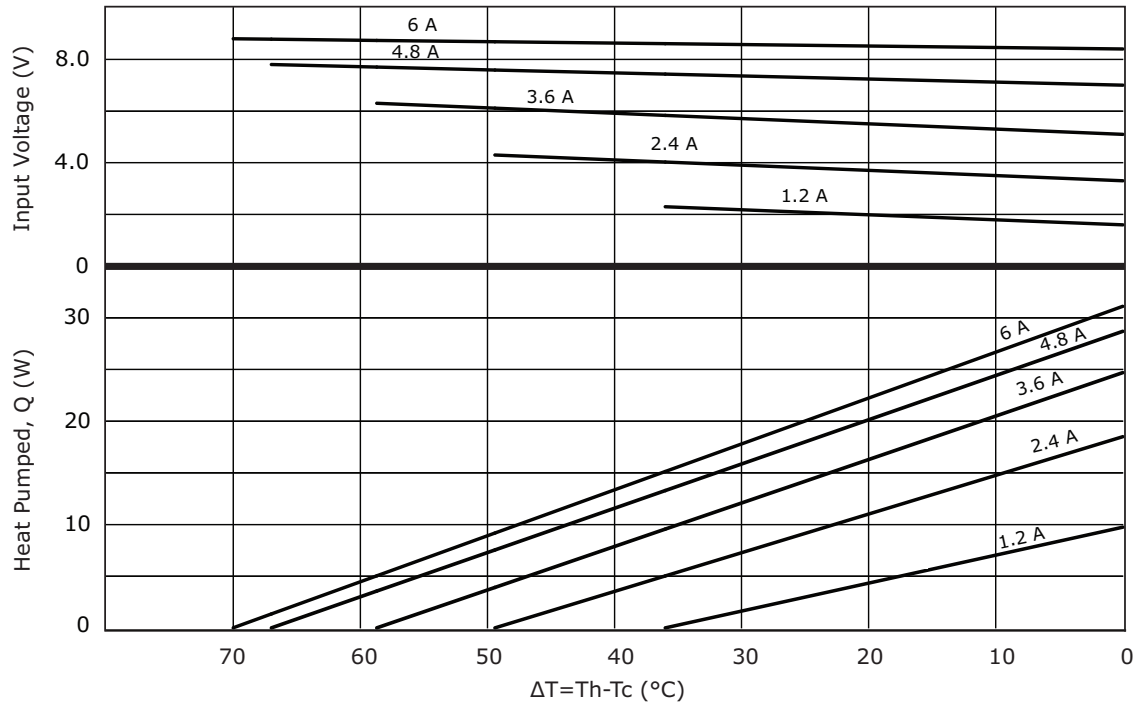

### CP603395H PERFORMANCE (Th=50°C)

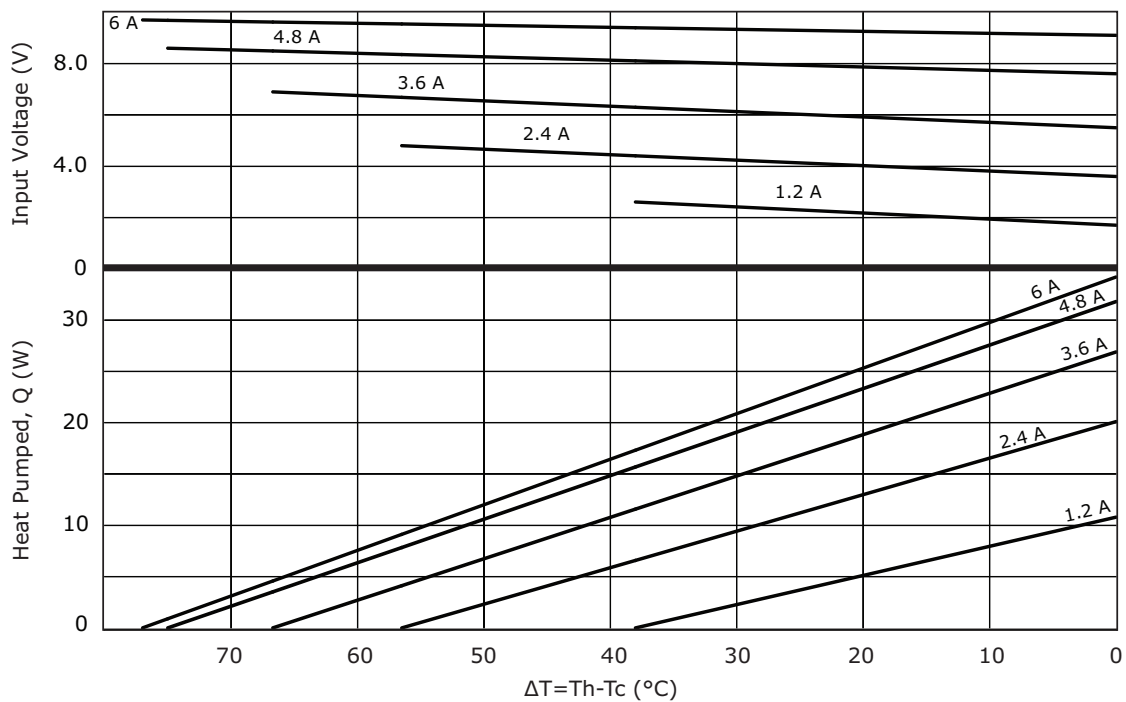

### CP604020395H PERFORMANCE (Th=27°C)

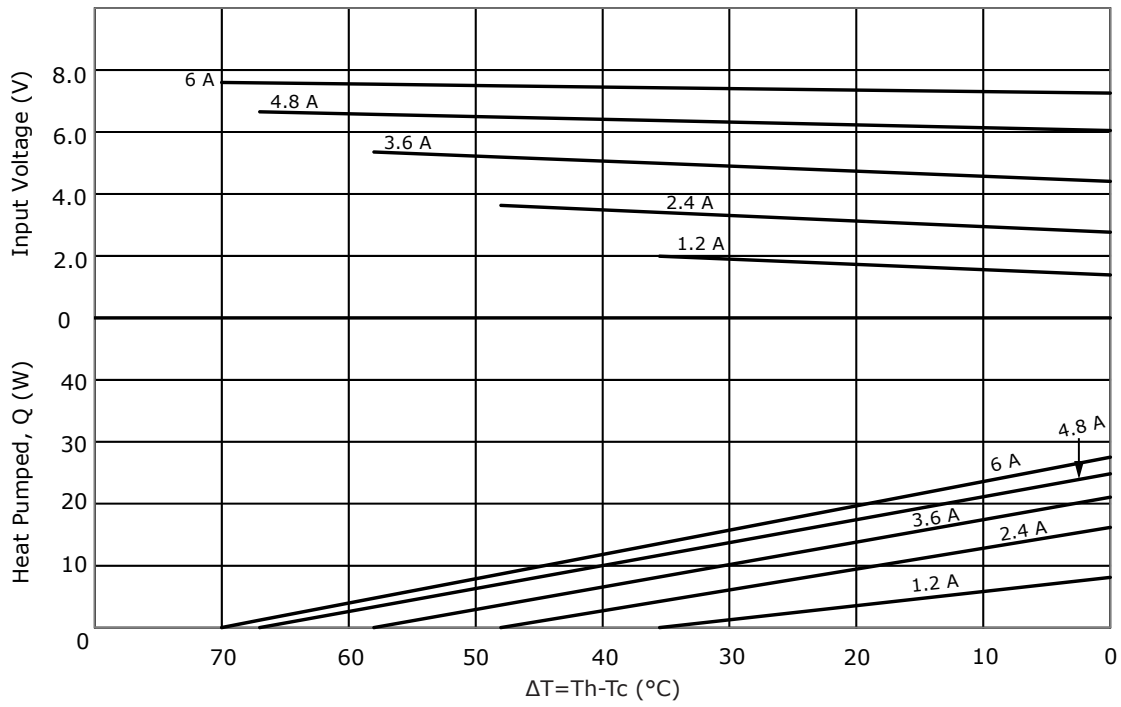

### CP604020395H PERFORMANCE (Th=50°C)

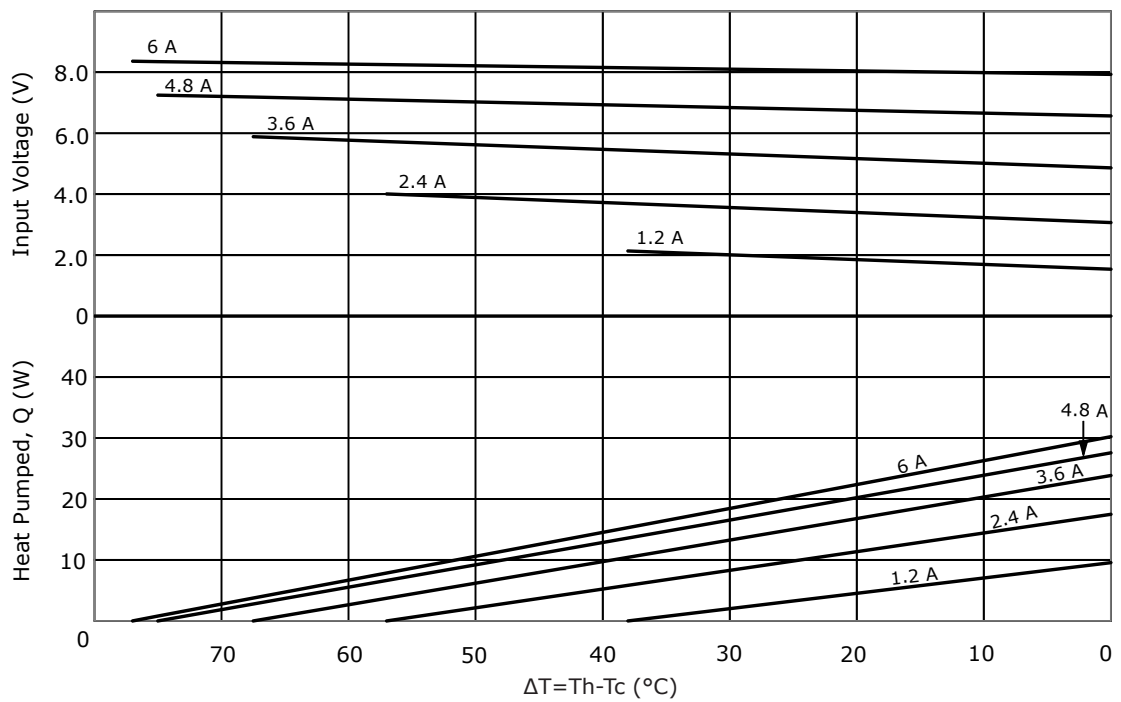

### CP60433H PERFORMANCE (Th=27°C)

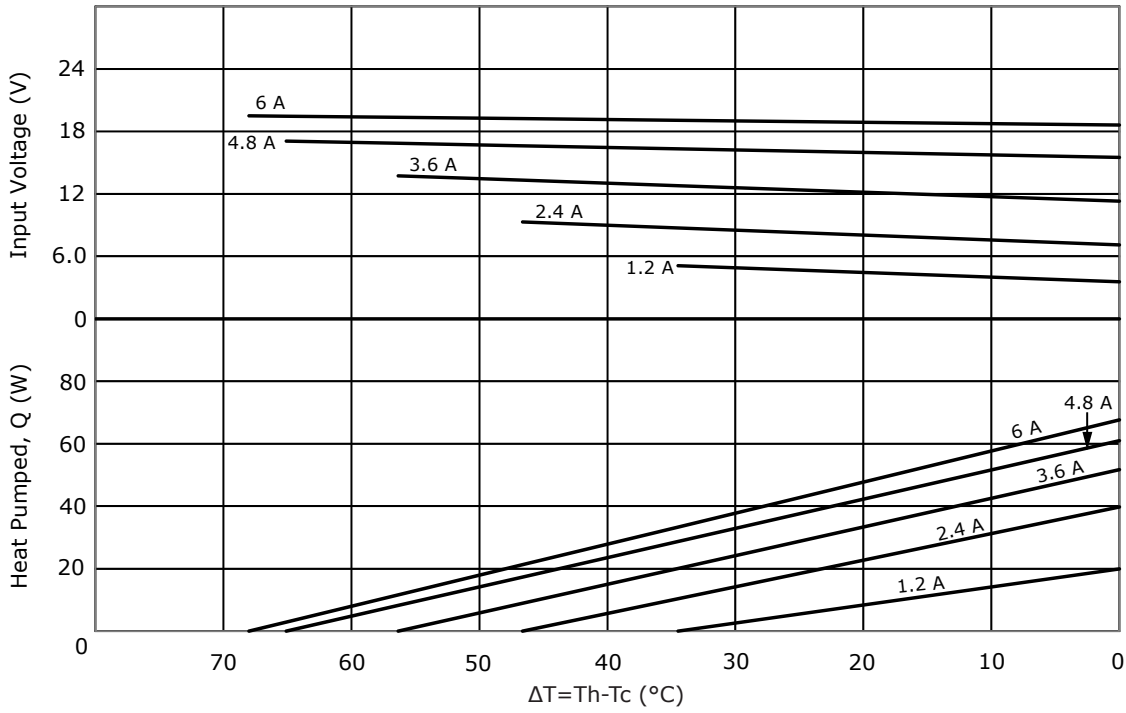

### CP60433H PERFORMANCE (Th=50°C)

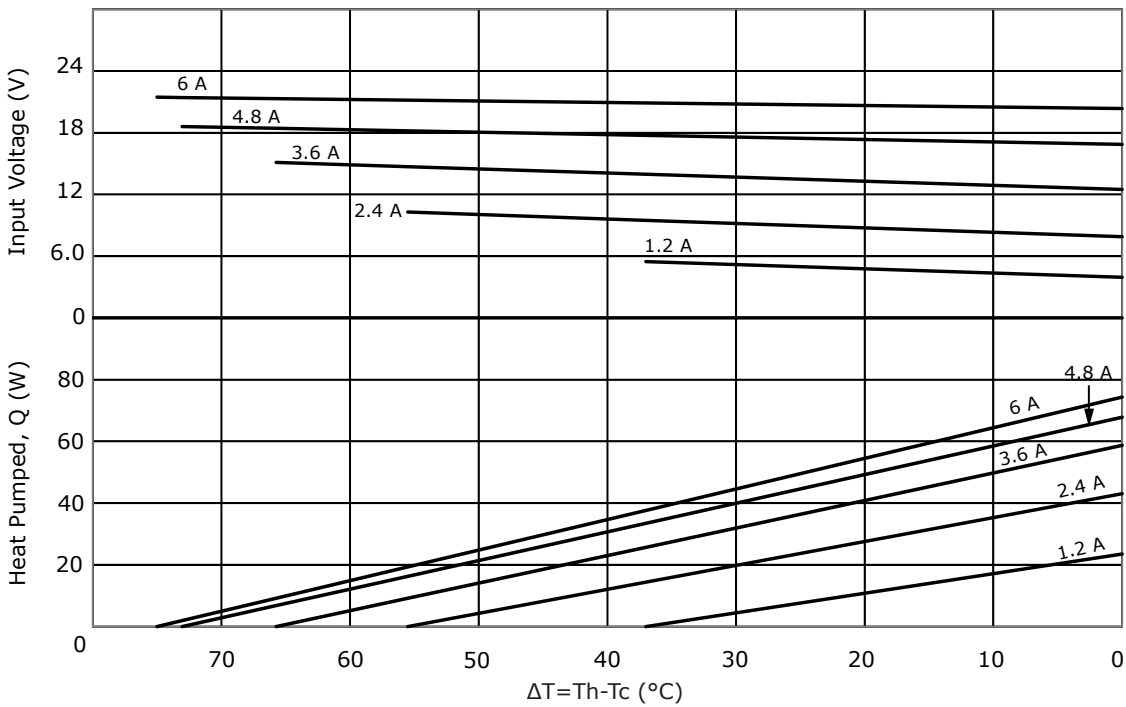

### CP604395H PERFORMANCE (Th=27°C)

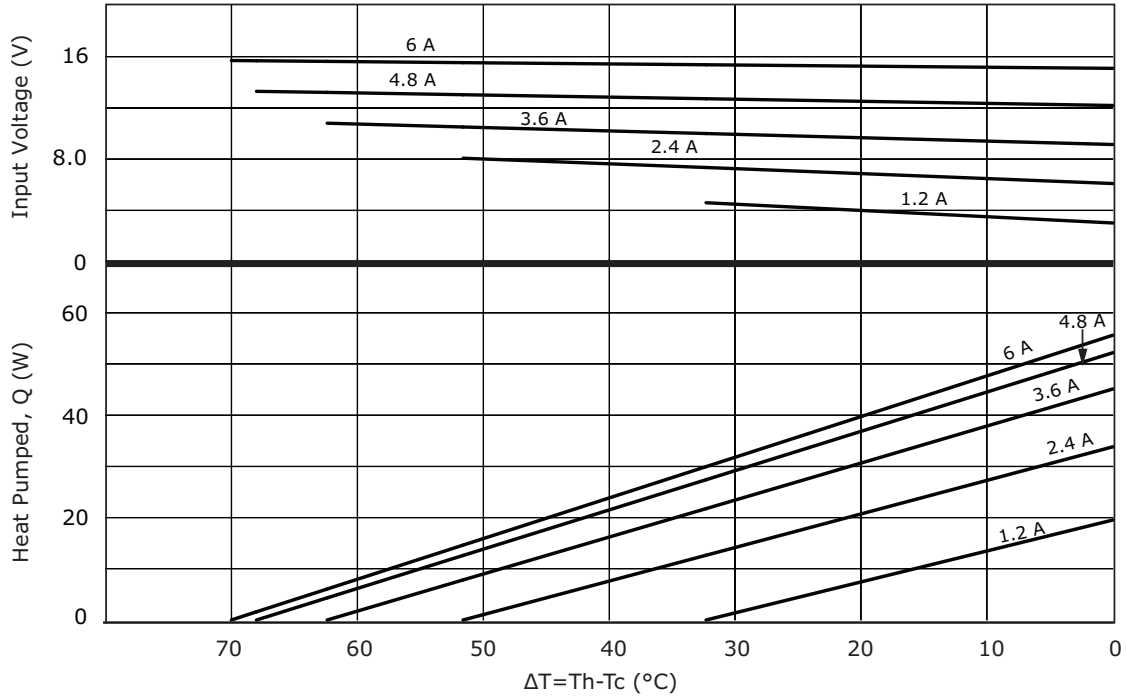

### CP604395H PERFORMANCE (Th=50°C)

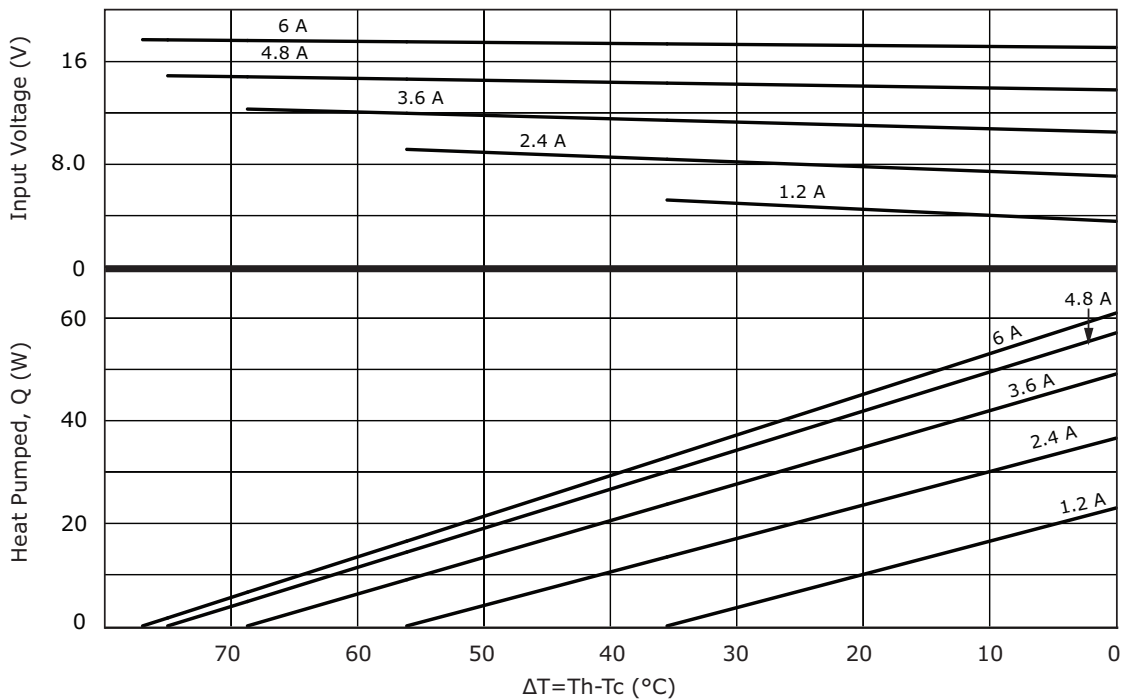



### CP604040 PERFORMANCE (Th=27°C)

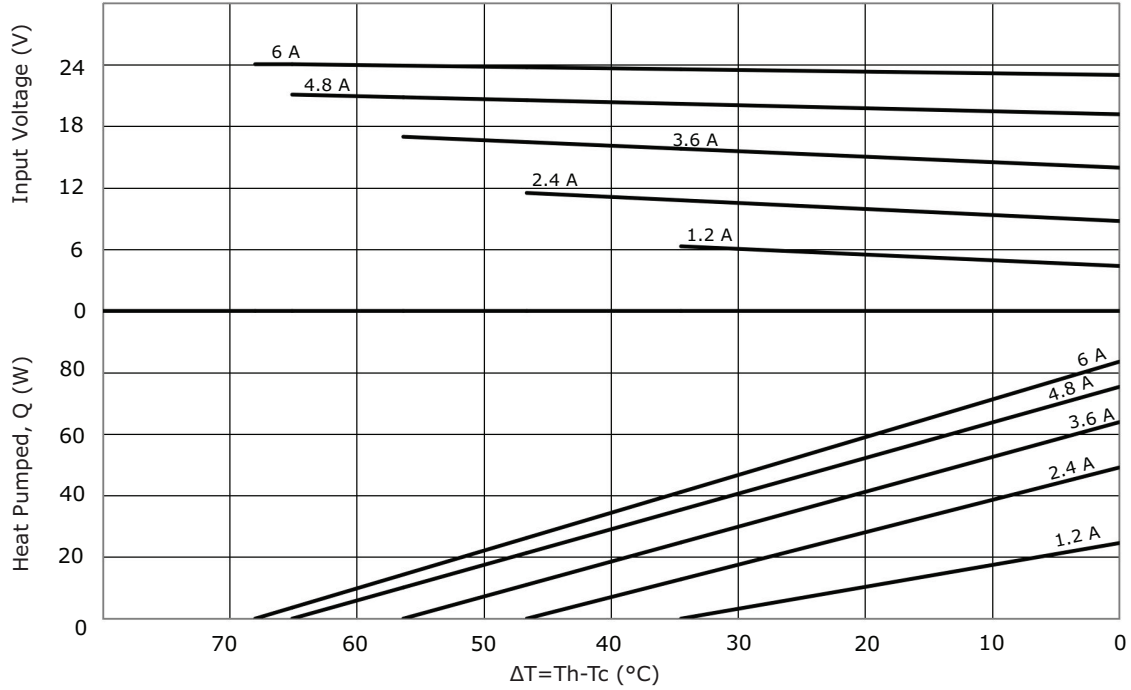

### CP604040 PERFORMANCE (Th=50°C)

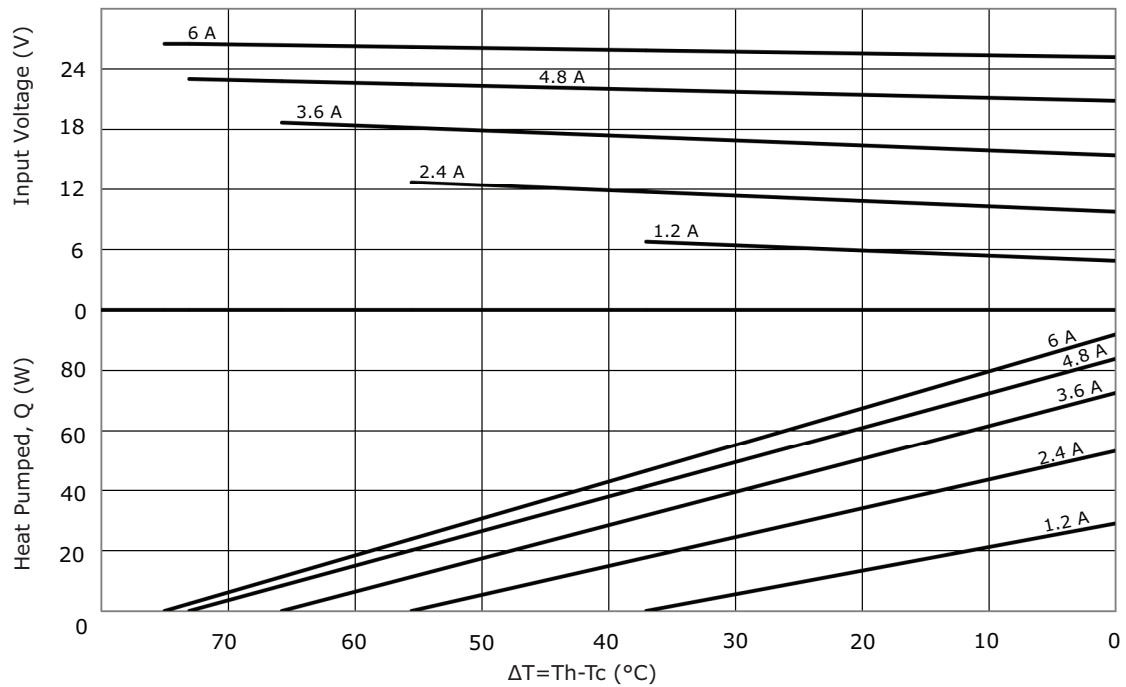

### CP60546241 PERFORMANCE (Th=27°C)

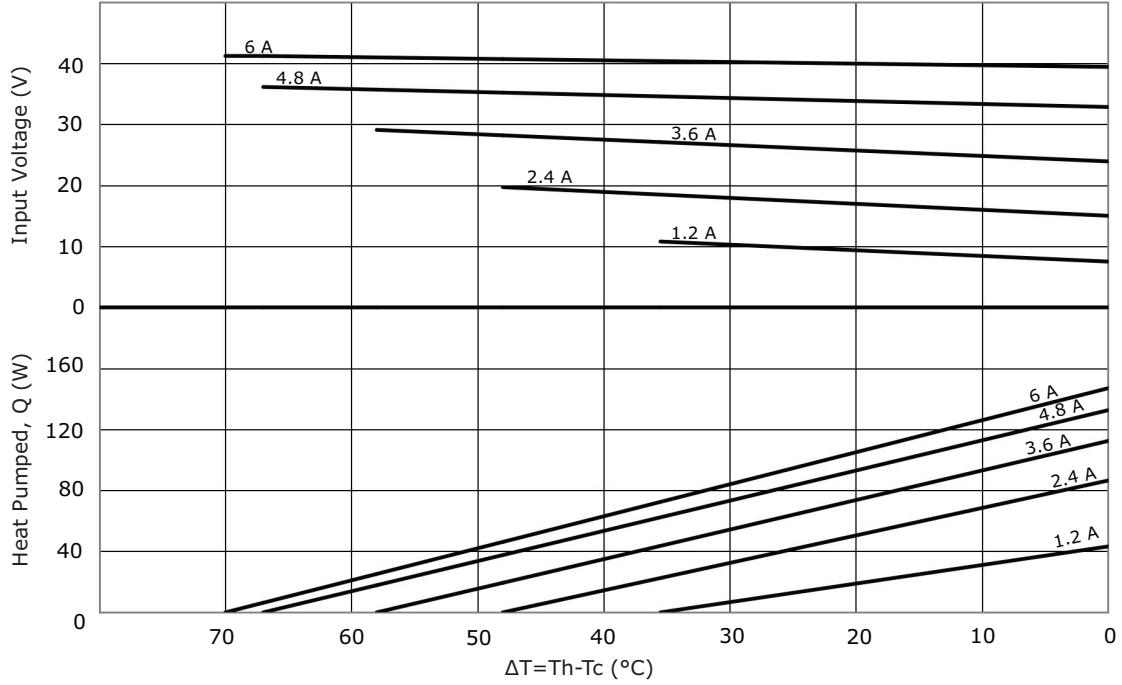

### CP60546241 PERFORMANCE (Th=50°C)

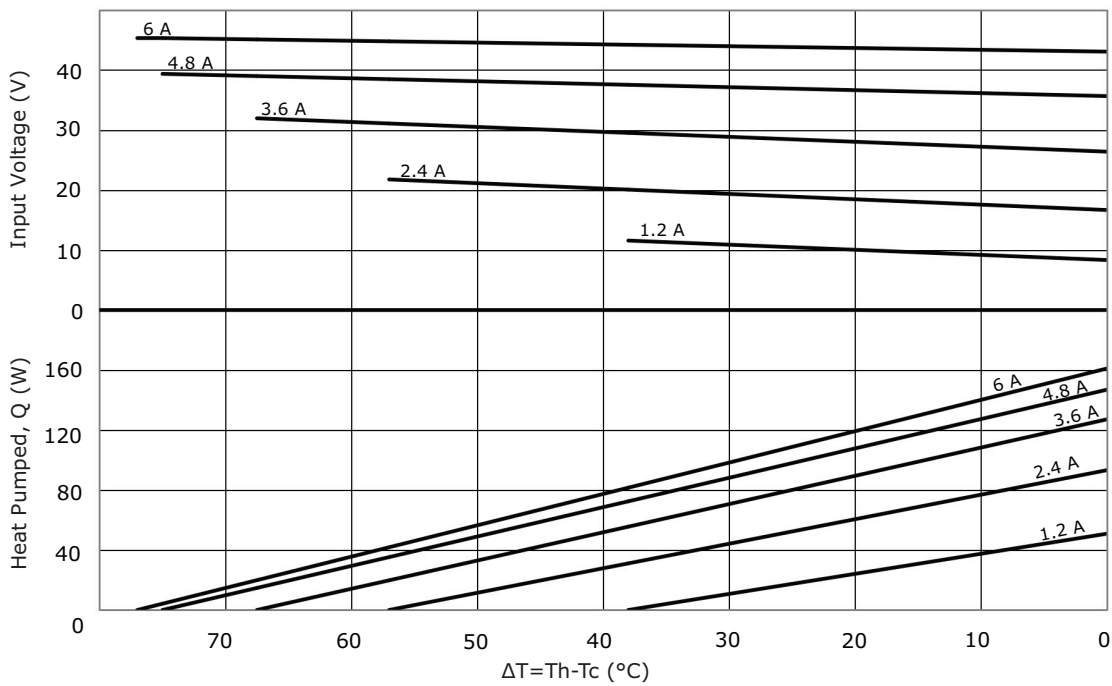

### CP6055354 PERFORMANCE (Th=27°C)

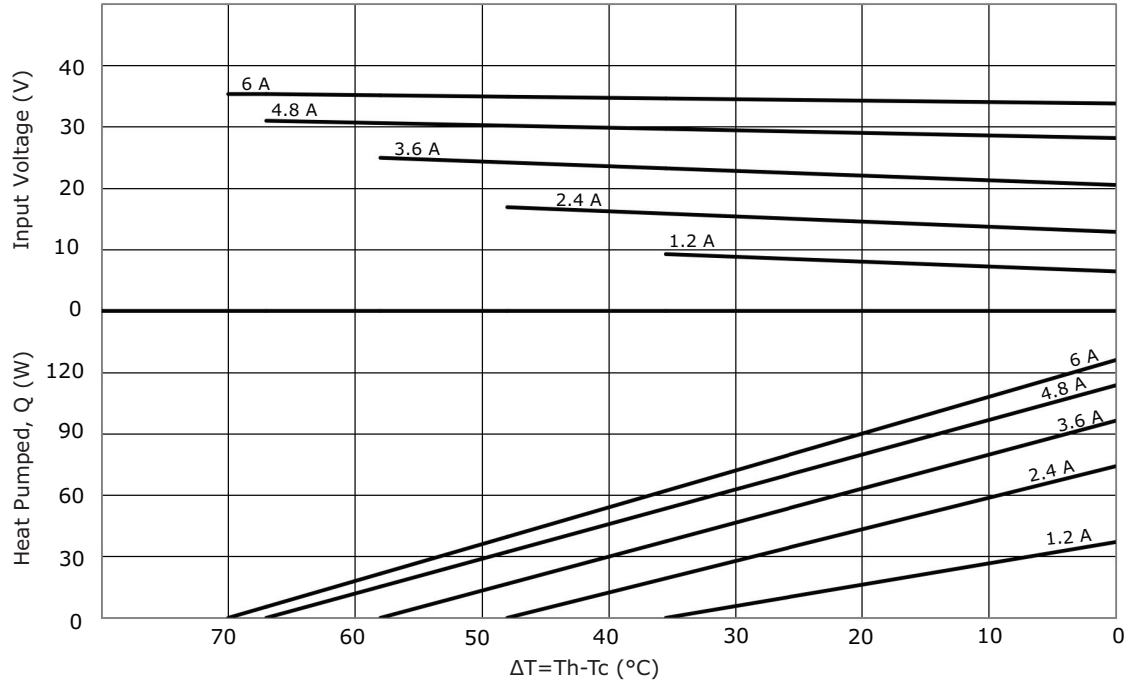

### CP6055354 PERFORMANCE (Th=50°C)

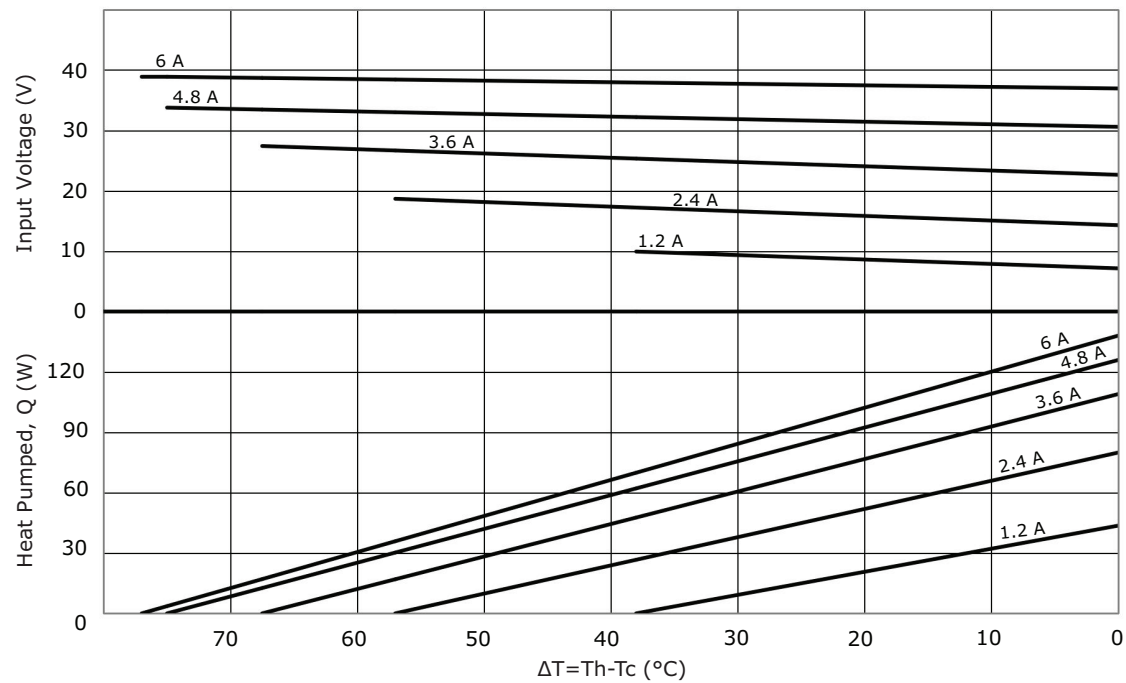

### CP6055542 PERFORMANCE (Th=27°C)

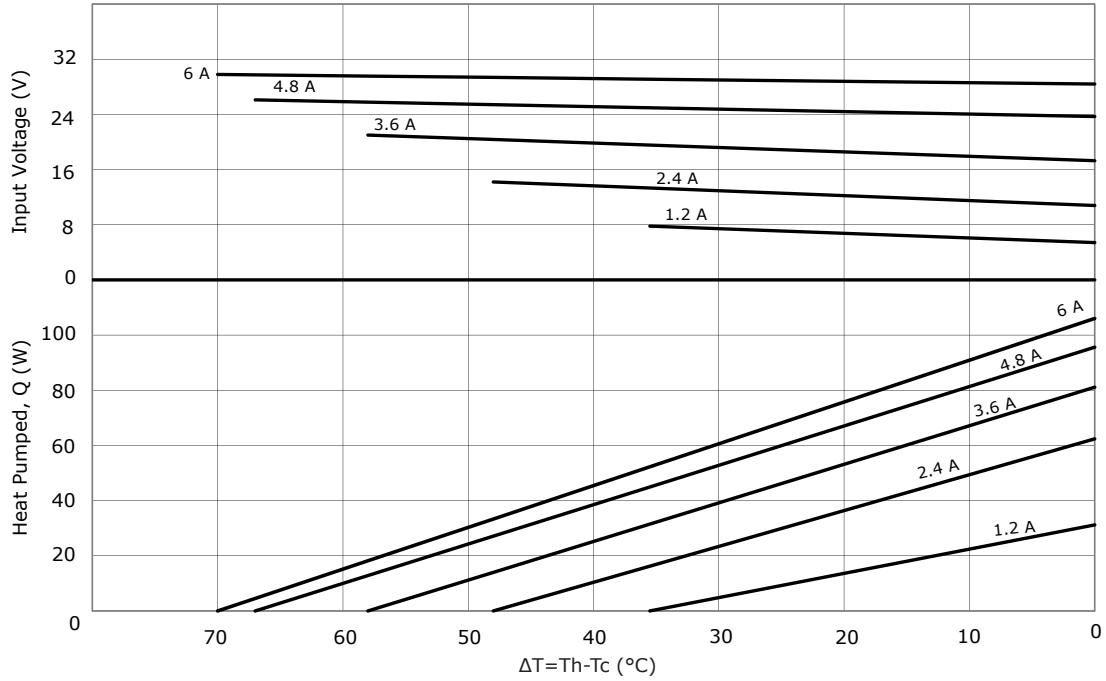

### CP6055542 PERFORMANCE (Th=50°C)

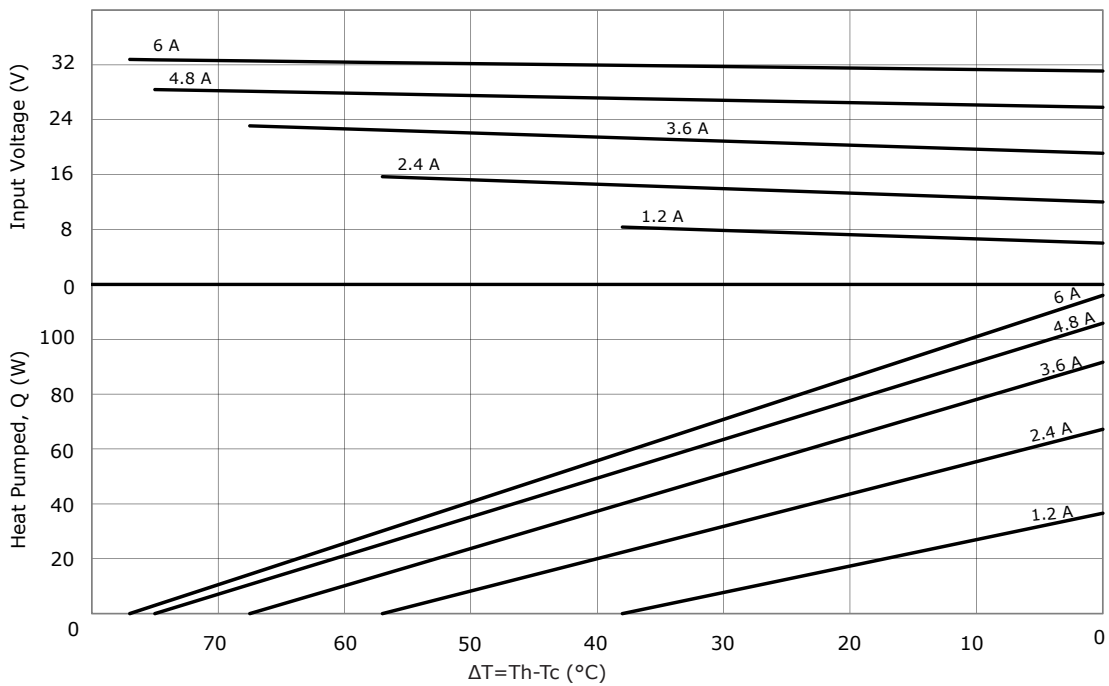

### CP604060395 PERFORMANCE (Th=27°C)

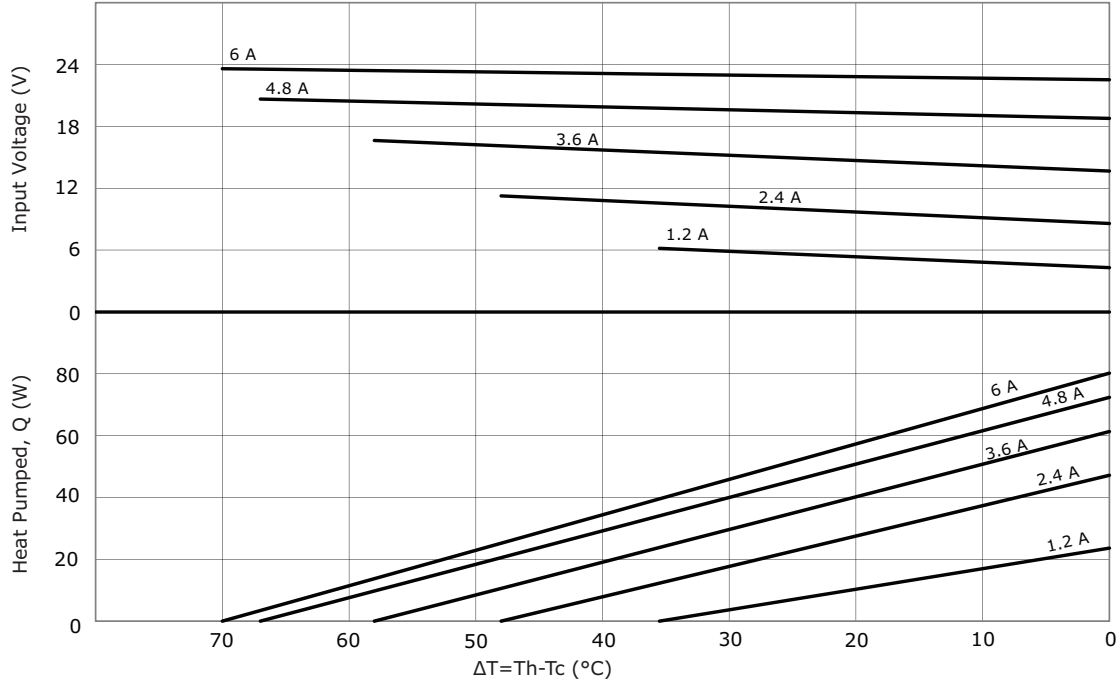

### CP604060395 PERFORMANCE (Th=50°C)

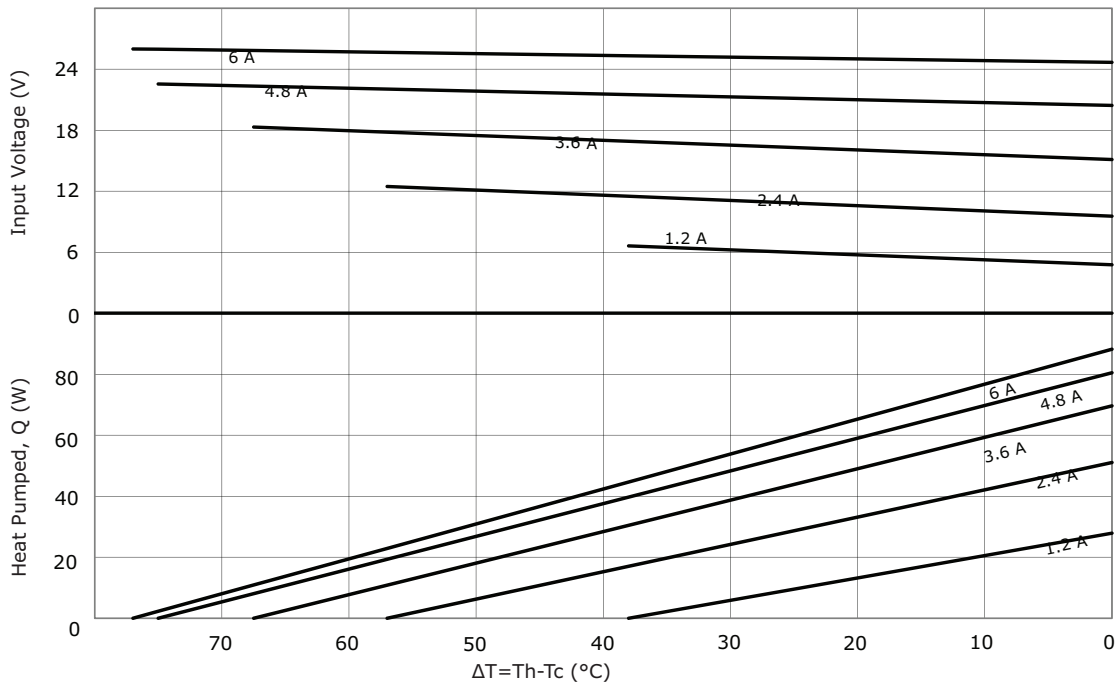

## REVISION HISTORY

---

| rev. | description  | date       |
|------|--|------------|
| 1.0  | initial release  | 09/08/2016 |
| 1.01 | updated datasheet  | 09/25/2017 |
| 1.02 | added new models   | 05/21/2018 |
| 1.03 | added models CP604060395, CP60555542, CP6030395, CP604040, CP6055354, CP60546241, brand update | 10/22/2019 |
| 1.04 | added model CP60302031H  | 11/12/2020 |

The revision history provided is for informational purposes only and is believed to be accurate.

---

# CUI DEVICES

CUI Devices offers a one (1) year limited warranty. Complete warranty information is listed on our website.

CUI Devices reserves the right to make changes to the product at any time without notice. Information provided by CUI Devices is believed to be accurate and reliable. However, no responsibility is assumed by CUI Devices for its use, nor for any infringements of patents or other rights of third parties which may result from its use.

CUI Devices products are not authorized or warranted for use as critical components in equipment that requires an extremely high level of reliability. A critical component is any component of a life support device or system whose failure to perform can be reasonably expected to cause the failure of the life support device or system, or to affect its safety or effectiveness.