

Features

- High speed
 - $t_{AA} = 10 \text{ ns}$
- Low active power
 - $I_{CC} = 90 \text{ mA}$ at 100 MHz
- Low complementary metal oxide semiconductor (CMOS) standby power
 - $I_{SB2} = 20 \text{ mA}$ (typical)
- Operating voltages of 2.2 V to 3.6 V
- 1.0 V data retention
- Automatic power-down when deselected
- Transistor-transistor logic (TTL) compatible inputs and outputs
- Easy memory expansion with \overline{CE}_1 and CE_2 features
- Available in Pb-free 54-pin thin small outline package (TSOP) Type II and 48-ball very fine-pitch ball grid array (VFBGA) packages.

Functional Description

The CY7C1069GN is a high performance CMOS Static RAM organized as 2,097,152 words by 8 bits.

To write to the device, take Chip Enables (\overline{CE}_1 LOW and CE_2 HIGH) and Write Enable (\overline{WE}) input LOW. Data on the eight I/O pins (I/O_0 through I/O_7) is then written into the location specified on the address pins (A_0 through A_{20}).

To read from the device, take Chip Enables (\overline{CE}_1 LOW and CE_2 HIGH) and Output Enable (\overline{OE}) LOW while forcing the Write Enable (\overline{WE}) HIGH. Under these conditions, the contents of the memory location specified by the address pins will appear on the I/O pins. See Truth Table on page 10 for a complete description of Read and Write modes.

The input and output pins (I/O_0 through I/O_7) are placed in a high impedance state when the device is deselected (\overline{CE}_1 HIGH or CE_2 LOW), the outputs are disabled (\overline{OE} HIGH), or during a write operation (\overline{CE}_1 LOW, CE_2 HIGH, and \overline{WE} LOW).

The CY7C1069GN is available in a 54-pin TSOP II and a 48-ball very fine-pitch ball grid array (VFBGA) package.

Logic Block Diagram

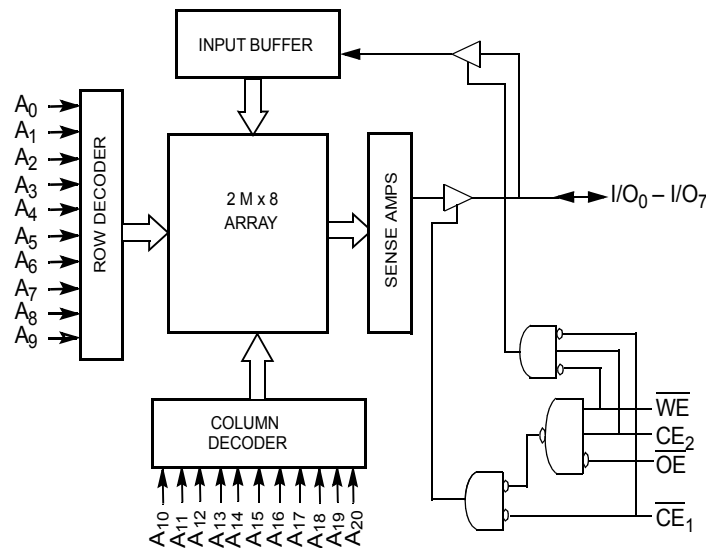

Contents

Selection Guide	3	Ordering Information	10
Pin Configurations	3	Ordering Code Definitions	10
Maximum Ratings	4	Package Diagrams	11
Operating Range	4	Acronyms	13
DC Electrical Characteristics	4	Document Conventions	13
Capacitance	5	Units of Measure	13
Thermal Resistance	5	Document History Page	14
AC Test Loads and Waveforms	5	Sales, Solutions, and Legal Information	15
Data Retention Characteristics	6	Worldwide Sales and Design Support	15
Data Retention Waveform	6	Products	15
AC Switching Characteristics	7	PSoC® Solutions	15
Switching Waveforms	8	Cypress Developer Community	15
Truth Table	10	Technical Support	15

Selection Guide

Description	-10	Unit
Maximum access time	10	ns
Maximum operating current	110	mA
Maximum CMOS standby current	30	mA

Pin Configurations

Figure 1. 54-pin TSOP II pinout (Top View) [1]

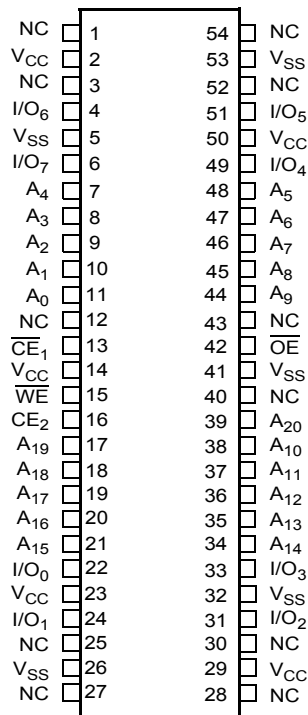
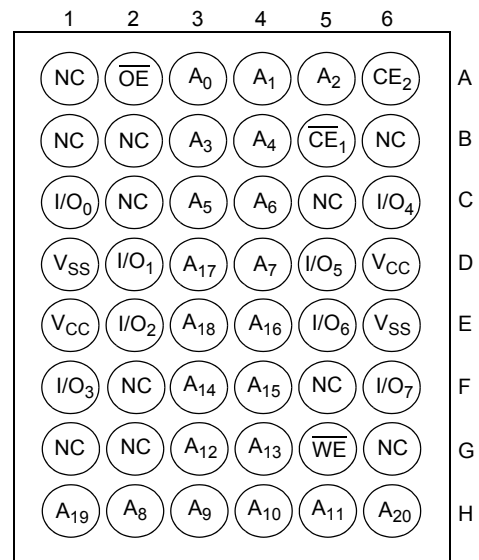

Figure 2. 48-ball VFBGA pinout (Top View) [1]



Note

1. NC pins are not connected on the die.

Maximum Ratings

Exceeding maximum ratings may shorten the useful life of the device. These user guidelines are not tested.

Storage temperature -65 °C to +150 °C

Ambient temperature
with power applied -55 °C to +125 °C

Supply voltage
on V_{CC} relative to GND ^[2] -0.5 V to $V_{CC} + 0.5$ V

DC voltage applied to outputs
in High Z state ^[2] -0.5 V to $V_{CC} + 0.5$ V

DC input voltage ^[2] -0.5 V to $V_{CC} + 0.5$ V

Current into outputs (LOW) 20 mA

Static discharge voltage
(MIL-STD-883, method 3015) > 2001 V

Latch-up current > 140 mA

Operating Range

Range	Ambient Temperature	V_{CC}
Industrial	-40 °C to +85 °C	3.3 V \pm 0.3 V

DC Electrical Characteristics

Over the Operating Range

Parameter	Description	Test Conditions	-10ns			Unit	
			Min	Typ ^[3]	Max		
V_{OH}	Output HIGH voltage	2.2 V to 2.7 V	Min V_{CC} , $I_{OH} = -1.0$ mA	2.0	-	-	V
		2.7 V to 3.0 V	Min V_{CC} , $I_{OH} = -4.0$ mA	2.2	-	-	
		3.0 V to 3.6 V	Min V_{CC} , $I_{OH} = -4.0$ mA	2.4	-	-	
V_{OL}	Output LOW voltage	2.2 V to 2.7 V	Min V_{CC} , $I_{OL} = 2.0$ mA	-	-	0.4	V
		2.7 V to 3.6 V	Min V_{CC} , $I_{OL} = 8.0$ mA	-	-	0.4	
V_{IH}	Input HIGH voltage	2.2 V to 2.7 V	-	2.0	-	$V_{CC} + 0.3$	V
		2.7 V to 3.6 V	-	2.0	-	$V_{CC} + 0.3$	
V_{IL}	Input LOW voltage ^[2]	2.2 V to 2.7 V	-	-0.3	-	0.6	V
		2.7 V to 3.6 V	-	-0.3	-	0.8	
I_{IX}	Input leakage current	$GND \leq V_{IN} \leq V_{CC}$	-1		+1	μ A	
I_{OZ}	Output leakage current	$GND \leq V_{OUT} \leq V_{CC}$, Output disabled	-1		+1	μ A	
I_{CC}	V_{CC} operating supply current	$V_{CC} = \text{Max}$, $f = f_{MAX} = 1/t_{RC}$, $I_{OUT} = 0$ mA, CMOS levels	-	90	110	mA	
I_{SB1}	Automatic CE power-down current – TTL inputs	Max V_{CC} , $\overline{CE}_1 \geq V_{IH}$, $CE_2 \leq V_{IL}$, $V_{IN} \geq V_{IH}$ or $V_{IN} \leq V_{IL}$, $f = f_{MAX}$	-	-	40	mA	
I_{SB2}	Automatic CE power-down current – CMOS inputs	Max V_{CC} , $CE_1 \geq V_{CC} - 0.3$ V, $CE_2 \leq 0.3$ V, $V_{IN} \geq V_{CC} - 0.3$ V or $V_{IN} \leq 0.3$ V, $f = 0$	-	20	30	mA	

Notes

2. $V_{IL(min)} = -2.0$ V and $V_{IH(max)} = V_{CC} + 2$ V for pulse durations of less than 20 ns.

3. Typical values are included for reference only and are not guaranteed or tested. Typical values are measured at $V_{CC} = 3$ V (for V_{CC} range of 2.2 V–3.6 V)

Capacitance

Parameter ^[4]	Description	Test Conditions	TSOP II	VFBGA	Unit
C _{IN}	Input capacitance	T _A = 25 °C, f = 1 MHz, V _{CC} = 3.3 V	10	10	pF
C _{OUT}	IO capacitance		10	10	pF

Thermal Resistance

Parameter ^[4]	Description	Test Conditions	TSOP II	VFBGA	Unit
Θ _{JA}	Thermal resistance (junction to ambient)	Still air, soldered on a 3 × 4.5 inch, four layer printed circuit board	93.63	31.50	°C/W
Θ _{JC}	Thermal resistance (junction to case)		21.58	15.75	°C/W

AC Test Loads and Waveforms

Figure 3. AC Test Loads and Waveforms ^[5]

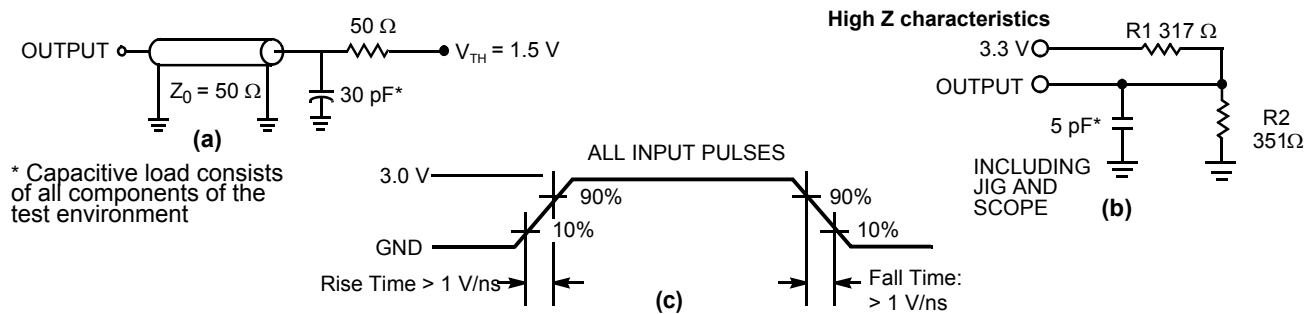

Notes

- 4. Tested initially and after any design or process changes that may affect these parameters.
- 5. Full device AC operation assumes a 100-μs ramp time from 0 to V_{CC(min)} and 100-μs wait time after V_{CC} stabilization.

Data Retention Characteristics

Over the Operating Range

Parameter	Description	Conditions	Min	Max	Unit
V_{DR}	V_{CC} for data retention	–	1.0	–	V
I_{CCDR}	Data retention current	$V_{CC} = V_{DR}$, $\overline{CE}_1 \geq V_{CC} - 0.2\text{ V}$, $CE_2 \leq 0.2\text{ V}$, $V_{IN} \geq V_{CC} - 0.2\text{ V}$ or $V_{IN} \leq 0.2\text{ V}$	–	30	mA
$t_{CDR}^{[6]}$	Chip deselect to data retention time	–	0	–	ns
$t_R^{[7]}$	Operation recovery time	–	10	–	ns

Data Retention Waveform

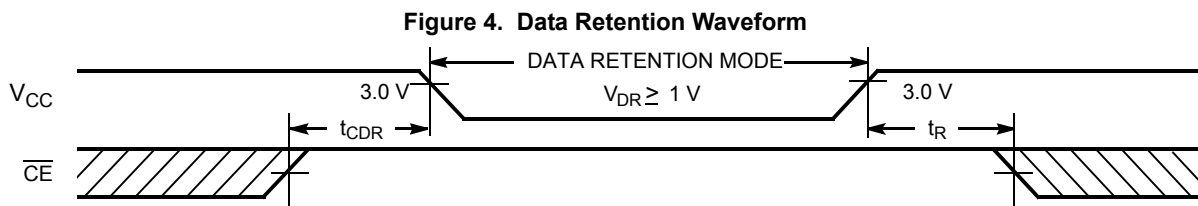

Notes

6. Tested initially and after any design or process changes that may affect these parameters.
7. Full device operation requires linear V_{CC} ramp from V_{DR} to $V_{CC(min.)} > 100\ \mu\text{s}$ or stable at $V_{CC(min.)} > 100\ \mu\text{s}$.

AC Switching Characteristics

Over the Operating Range

Parameter [8]	Description	-10		Unit
		Min	Max	
Read Cycle				
t_{power}	V_{CC} (typical) to the first access [9, 10]	100	–	μs
t_{RC}	Read cycle time	10	–	ns
t_{AA}	Address to data valid	–	10	ns
t_{OHA}	Data hold from address change	3	–	ns
t_{ACE}	$\overline{\text{CE}}_1$ LOW/ CE_2 HIGH to data valid	–	10	ns
t_{DOE}	$\overline{\text{OE}}$ LOW to data valid	–	5	ns
t_{LZOE}	$\overline{\text{OE}}$ LOW to low Z [11, 12, 13]	0	–	ns
t_{HZOE}	$\overline{\text{OE}}$ HIGH to high Z [11, 12, 13]	–	5	ns
t_{LZCE}	$\overline{\text{CE}}_1$ LOW/ CE_2 HIGH to low Z [11, 12, 13]	3	–	ns
t_{HZCE}	$\overline{\text{CE}}_1$ HIGH/ CE_2 LOW to high Z [11, 12, 13]	–	5	ns
t_{PU}	$\overline{\text{CE}}_1$ LOW/ CE_2 HIGH to power-up [10]	0	–	ns
t_{PD}	$\overline{\text{CE}}_1$ HIGH/ CE_2 LOW to power-down [10]	–	10	ns
Write Cycle [14, 15]				
t_{WC}	Write cycle time	10	–	ns
t_{SCE}	$\overline{\text{CE}}_1$ LOW/ CE_2 HIGH to write end	7	–	ns
t_{AW}	Address setup to write end	7	–	ns
t_{HA}	Address hold from write end	0	–	ns
t_{SA}	Address setup to write start	0	–	ns
t_{PWE}	$\overline{\text{WE}}$ pulse width	7	–	ns
t_{SD}	Data setup to write end	5	–	ns
t_{HD}	Data hold from write end	0	–	ns
t_{LZWE}	$\overline{\text{WE}}$ HIGH to low Z [11, 12, 13]	3	–	ns
t_{HZWE}	$\overline{\text{WE}}$ LOW to high Z [11, 12, 13]	–	5	ns

Notes

8. Test conditions assume signal transition time of 3 ns or less, timing reference levels of 1.5 V, and input pulse levels of 0 to 3.0 V. Test conditions for the read cycle use output loading shown in (a) of [Figure 3 on page 5](#), unless specified otherwise.
9. t_{POWER} gives the minimum amount of time that the power supply is at typical V_{CC} values until the first memory access is performed.
10. These parameters are guaranteed by design and are not tested.
11. t_{HZOE} , t_{HZCE} , t_{HZWE} , t_{LZOE} , t_{LZCE} , and t_{LZWE} are specified with a load capacitance of 5 pF as in (b) of [Figure 3 on page 5](#). Transition is measured ± 200 mV from steady state voltage.
12. At any temperature and voltage condition, t_{HZCE} is less than t_{LZCE} , t_{HZBE} is less than t_{LZBE} , t_{HZOE} is less than t_{LZOE} , and t_{HZWE} is less than t_{LZWE} for any device. These parameters are guaranteed by design and are not tested.
13. Tested initially and after any design or process changes that may affect these parameters.
14. The internal write time of the memory is defined by the overlap of $\overline{\text{WE}}$, $\overline{\text{CE}}_1 = V_{\text{IL}}$, and $\text{CE}_2 = V_{\text{IH}}$. $\overline{\text{CE}}_1$ and $\overline{\text{WE}}$ are LOW along with CE_2 HIGH to initiate a write, and the transition of any of these signals can terminate. The input data setup and hold timing should be referenced to the edge of the signal that terminates the write.
15. The minimum write cycle time for Write Cycle No. 2 ($\overline{\text{WE}}$ Controlled, $\overline{\text{OE}}$ LOW) is the sum of t_{HZWE} and t_{SD} .

Switching Waveforms

Figure 5. Read Cycle No. 1 (Address Transition Controlled) [16, 17]

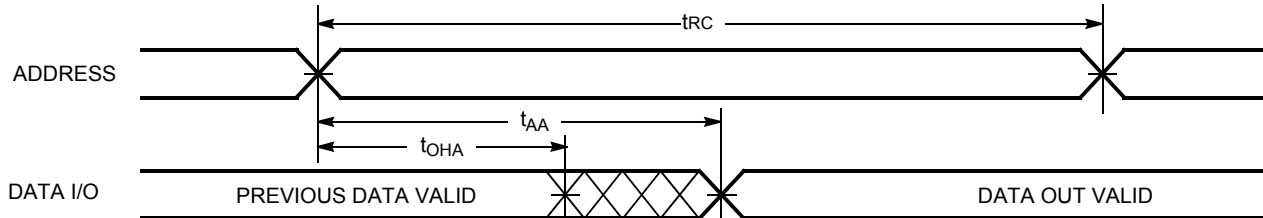
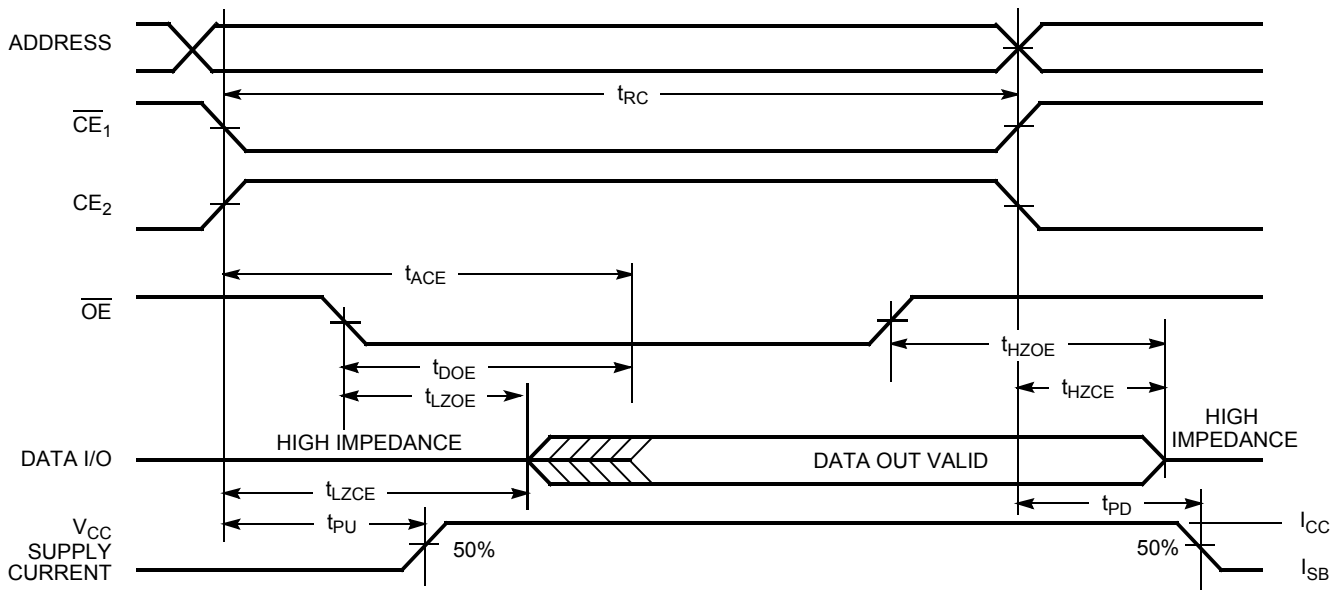

Figure 6. Read Cycle No. 2 ($\overline{\text{OE}}$ Controlled) [17, 18]



Notes

16. The device is continuously selected. $\overline{\text{CE}}_1 = V_{IL}$, and $\text{CE}_2 = V_{IH}$.
17. $\overline{\text{WE}}$ is HIGH for read cycle.
18. Address valid before or similar to $\overline{\text{CE}}_1$ transition LOW and CE_2 transition HIGH.

Switching Waveforms (continued)

Figure 7. Write Cycle No. 1 (\overline{CE} Controlled) [19, 20, 21, 22]

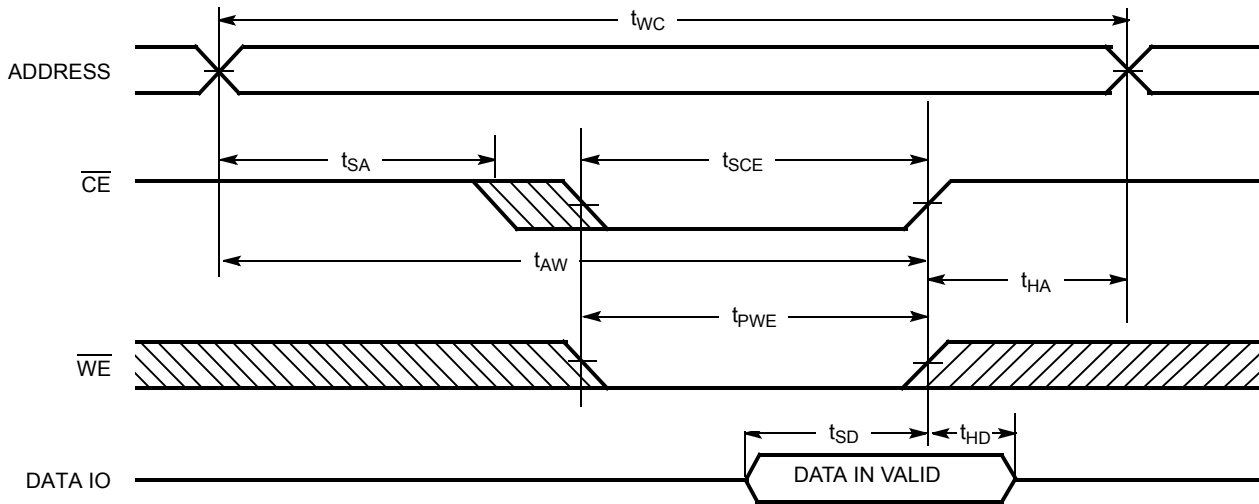
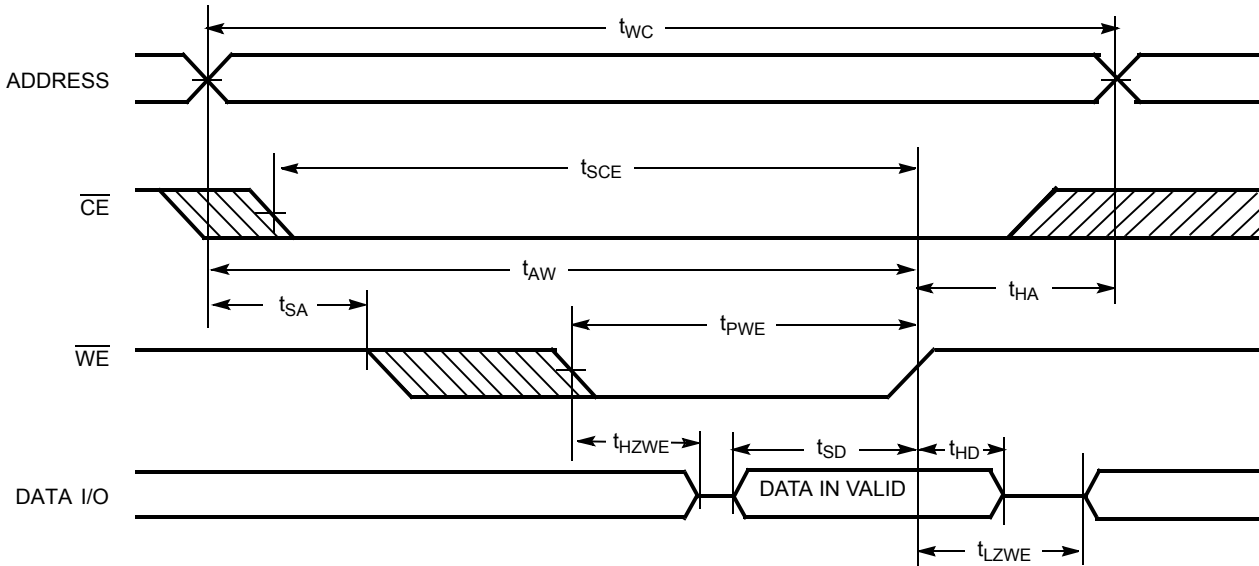

Figure 8. Write Cycle No. 2 (\overline{WE} Controlled, \overline{OE} LOW) [19, 20, 21, 22]



Notes

- 19. \overline{CE} is a shorthand combination of both \overline{CE}_1 and CE_2 combined. It is active LOW.
- 20. Data I/O is high impedance if $\overline{OE} = V_{IH}$.
- 21. If \overline{CE} goes HIGH simultaneously with \overline{WE} going HIGH, the output remains in a high impedance state.
- 22. The internal write time of the memory is defined by the overlap of $WE = V_{IL}$, $CE = V_{IL}$. These signals must be LOW to initiate a write, and the HIGH transition of any of these signals can terminate the operation. The input data setup and hold timing should be referenced to the edge of the signal that terminates the write.

Truth Table

\overline{CE}_1	\overline{CE}_2	\overline{OE}	\overline{WE}	I/O ₀ –I/O ₇	Mode	Power
H	X	X	X	High Z	Power-down	Standby (I _{SB})
X	L	X	X	High Z	Power-down	Standby (I _{SB})
L	H	L	H	Data out	Read all bits	Active (I _{CC})
L	H	X	L	Data in	Write all bits	Active (I _{CC})
L	H	H	H	High Z	Selected, outputs disabled	Active (I _{CC})

Ordering Information

Speed (ns)	Ordering Code	Package Diagram	Package Type	Operating Range
10	CY7C1069GN30-10ZSXI	51-85160	54-pin TSOP II (Pb-free)	Industrial
	CY7C1069GN30-10ZSXIT	51-85160	54-pin TSOP II (Pb-free), Tape and Reel	
	CY7C1069GN30-10BVXI	51-85150	48-ball VFBGA (Pb-free)	
	CY7C1069GN30-10BVXIT	51-85150	48-ball VFBGA (Pb-free), Tape and Reel	

Ordering Code Definitions

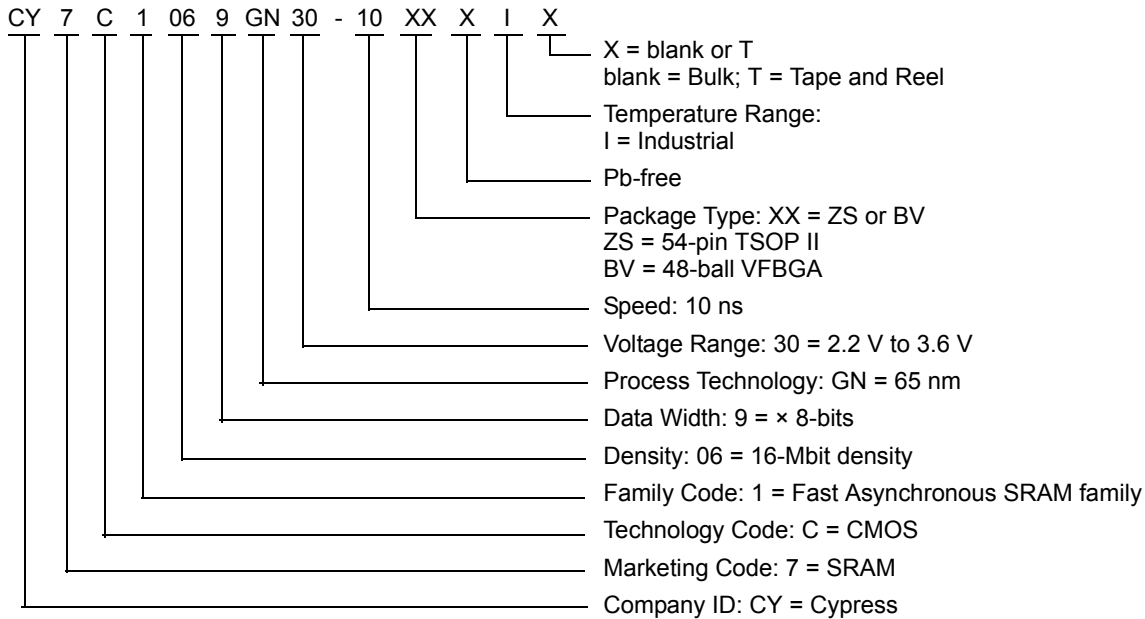

Package Diagrams

Figure 9. 54-pin TSOP II (22.4 × 11.84 × 1.0 mm) Z54-II Package Outline, 51-85160

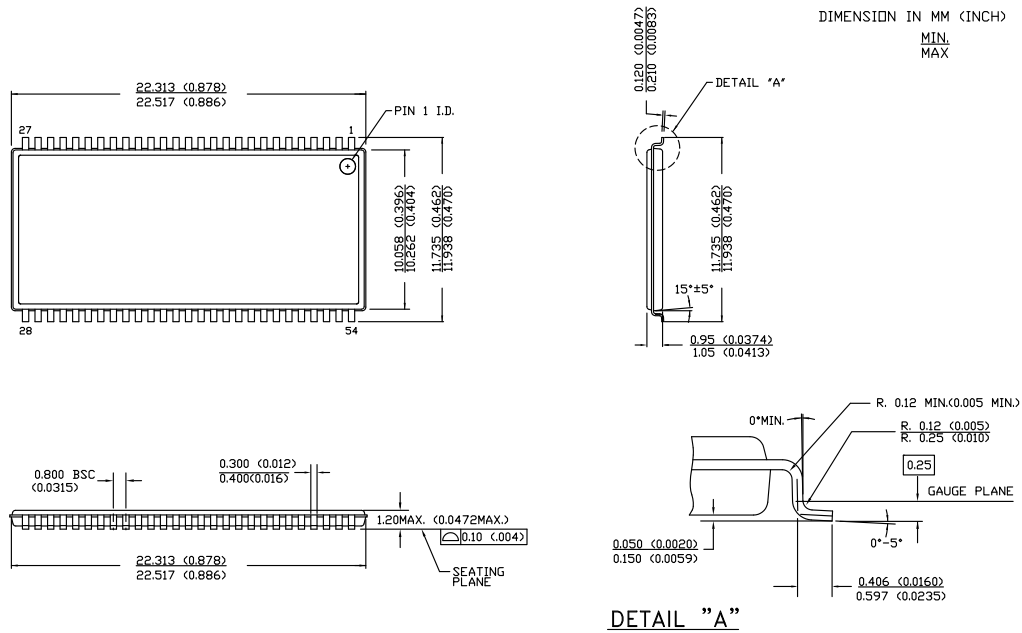

51-85160 *E

Package Diagrams (continued)

Figure 10. 48-ball VFBGA (6 × 8 × 1.0 mm) BV48/BZ48 Package Outline, 51-85150

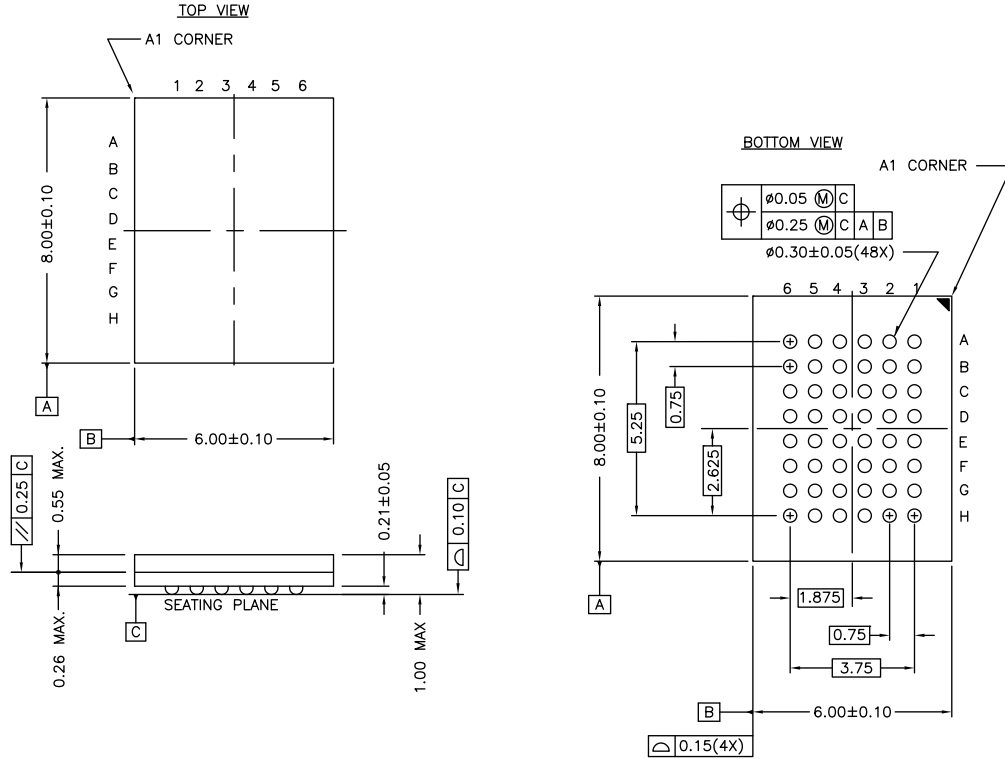

NOTE:
 PACKAGE WEIGHT: See Cypress Package Material Declaration Datasheet (PMDD)
 posted on the Cypress web.

51-85150 *H

Acronyms

Acronym	Description
\overline{CE}	chip enable
CMOS	complementary metal oxide semiconductor
I/O	input/output
\overline{OE}	output enable
SRAM	static random access memory
VFBGA	very fine-pitch ball grid array
TSOP	thin small outline package
TTL	transistor-transistor logic
\overline{WE}	write enable

Document Conventions

Units of Measure

Symbol	Unit of Measure
°C	degree Celsius
MHz	megahertz
μA	microampere
μs	microsecond
mA	milliampere
ns	nanosecond
Ω	ohm
%	percent
pF	picofarad
V	volt
W	watt

Document History Page

Document Title: CY7C1069GN, 16-Mbit (2M × 8) Static RAM Document Number: 002-00046				
Rev.	ECN No.	Orig. of Change	Submission Date	Description of Change
**	4948206	NILE	10/13/2015	New data sheet
*A	5437942	NILE	09/15/2016	Updated DC Electrical Characteristics : Removed Operating Range “2.7 V to 3.6 V” and all values corresponding to V _{OH} parameter. Included Operating Ranges “2.7 V to 3.0 V” and “3.0 V to 3.6 V” and all values corresponding to V _{OH} parameter. Updated Ordering Information : Updated part numbers. Updated Ordering Code Definitions . Updated to new template. Completing Sunset Review.
*B	5999403	AESATMP8	12/19/2017	Updated logo and Copyright.

Sales, Solutions, and Legal Information

Worldwide Sales and Design Support

Cypress maintains a worldwide network of offices, solution centers, manufacturer's representatives, and distributors. To find the office closest to you, visit us at [Cypress Locations](#).

Products

Arm [®] Cortex [®] Microcontrollers	cypress.com/arm
Automotive	cypress.com/automotive
Clocks & Buffers	cypress.com/clocks
Interface	cypress.com/interface
Internet of Things	cypress.com/iot
Memory	cypress.com/memory
Microcontrollers	cypress.com/mcu
PSoC	cypress.com/psoc
Power Management ICs	cypress.com/pmic
Touch Sensing	cypress.com/touch
USB Controllers	cypress.com/usb
Wireless Connectivity	cypress.com/wireless

PSoC[®] Solutions

[PSoC 1](#) | [PSoC 3](#) | [PSoC 4](#) | [PSoC 5LP](#) | [PSoC 6 MCU](#)

Cypress Developer Community

[Community](#) | [Projects](#) | [Video](#) | [Blogs](#) | [Training](#) | [Components](#)

Technical Support

cypress.com/support

© Cypress Semiconductor Corporation, 2015-2017. This document is the property of Cypress Semiconductor Corporation and its subsidiaries, including Spansion LLC ("Cypress"). This document, including any software or firmware included or referenced in this document ("Software"), is owned by Cypress under the intellectual property laws and treaties of the United States and other countries worldwide. Cypress reserves all rights under such laws and treaties and does not, except as specifically stated in this paragraph, grant any license under its patents, copyrights, trademarks, or other intellectual property rights. If the Software is not accompanied by a license agreement and you do not otherwise have a written agreement with Cypress governing the use of the Software, then Cypress hereby grants you a personal, non-exclusive, nontransferable license (without the right to sublicense) (1) under its copyright rights in the Software (a) for Software provided in source code form, to modify and reproduce the Software solely for use with Cypress hardware products, only internally within your organization, and (b) to distribute the Software in binary code form externally to end users (either directly or indirectly through resellers and distributors), solely for use on Cypress hardware product units, and (2) under those claims of Cypress's patents that are infringed by the Software (as provided by Cypress, unmodified) to make, use, distribute, and import the Software solely for use with Cypress hardware products. Any other use, reproduction, modification, translation, or compilation of the Software is prohibited.

TO THE EXTENT PERMITTED BY APPLICABLE LAW, CYPRESS MAKES NO WARRANTY OF ANY KIND, EXPRESS OR IMPLIED, WITH REGARD TO THIS DOCUMENT OR ANY SOFTWARE OR ACCOMPANYING HARDWARE, INCLUDING, BUT NOT LIMITED TO, THE IMPLIED WARRANTIES OF MERCHANTABILITY AND FITNESS FOR A PARTICULAR PURPOSE. No computing device can be absolutely secure. Therefore, despite security measures implemented in Cypress hardware or software products, Cypress does not assume any liability arising out of any security breach, such as unauthorized access to or use of a Cypress product. In addition, the products described in these materials may contain design defects or errors known as errata which may cause the product to deviate from published specifications. To the extent permitted by applicable law, Cypress reserves the right to make changes to this document without further notice. Cypress does not assume any liability arising out of the application or use of any product or circuit described in this document. Any information provided in this document, including any sample design information or programming code, is provided only for reference purposes. It is the responsibility of the user of this document to properly design, program, and test the functionality and safety of any application made of this information and any resulting product. Cypress products are not designed, intended, or authorized for use as critical components in systems designed or intended for the operation of weapons, weapons systems, nuclear installations, life-support devices or systems, other medical devices or systems (including resuscitation equipment and surgical implants), pollution control or hazardous substances management, or other uses where the failure of the device or system could cause personal injury, death, or property damage ("Unintended Uses"). A critical component is any component of a device or system whose failure to perform can be reasonably expected to cause the failure of the device or system, or to affect its safety or effectiveness. Cypress is not liable, in whole or in part, and you shall and hereby do release Cypress from any claim, damage, or other liability arising from or related to all Unintended Uses of Cypress products. You shall indemnify and hold Cypress harmless from and against all claims, costs, damages, and other liabilities, including claims for personal injury or death, arising from or related to any Unintended Uses of Cypress products.

Cypress, the Cypress logo, Spansion, the Spansion logo, and combinations thereof, WICED, PSoC, CapSense, EZ-USB, F-RAM, and Traveo are trademarks or registered trademarks of Cypress in the United States and other countries. For a more complete list of Cypress trademarks, visit cypress.com. Other names and brands may be claimed as property of their respective owners.