

HLMP-EL55/EG55

T-1³/₄ (5 mm) Precision Optical Performance AllnGaP LED Lamps



Description

These precision optical performance AllnGaP LEDs provide superior light output for excellent readability in sunlight and are extremely reliable. AllnGaP LED technology provides extremely stable light output over long periods of time. Precision optical performance lamps use the aluminum indium gallium phosphide (AllnGaP) technology.

These LED lamps are tinted, diffused, T-1³/₄ packages incorporating second-generation optics producing well-defined radiation patterns at specific viewing cone angles.

The high maximum LED junction temperature limit of +130°C enables high temperature operation in bright sunlight conditions.

These lamps are available in two package options to give the designer flexibility with device mounting.

Benefits

- Viewing angles match traffic management sign requirements
- Colors meet automotive specifications
- Superior performance in outdoor environments
- Suitable for autoinsertion onto PC boards

Features

- Well-defined and smooth spatial radiation patterns
- Wide viewing angle
- Tinted diffused lamp
- High luminous output
- Colors:
 - 590-nm Amber
 - 626-nm Red
- High operating temperature: $T_{JLED} = +130^{\circ}\text{C}$
- Superior resistance to moisture

Applications

- Traffic management:
 - Variable message signs
 - Traffic management signs
- Commercial indoor/outdoor advertising:
 - Signs
 - Marquees
 - Passenger information
- Automotive:
 - Exterior and interior lights

Device Selection Guide for AlInGaP

Part Number	Color and Dominant Wavelength λ_d (nm) Typ. ^a	Luminous Intensity I_v (mcd) at 20 mA Min. ^{b, c}	Luminous Intensity I_v (mcd) at 20 mA Max. ^{b, c}
HLMP-EL55-GK0DD	Amber 590	140	400
HLMP-EL55-LP0xx	Amber 590	400	1150
HLMP-EG55-GK0DD	Red 626	140	400
HLMP-EG55-HJ0xx	Red 626	180	310
HLMP-EG55-JK0xx	Red 626	240	400

- The dominant wavelength, λ_d , is derived from the CIE Chromaticity Diagram and represents the color of the lamp.
- The luminous intensity is measured on the mechanical axis of the lamp package.
- The optical axis is closely aligned with the package mechanical axis.

Package Dimensions

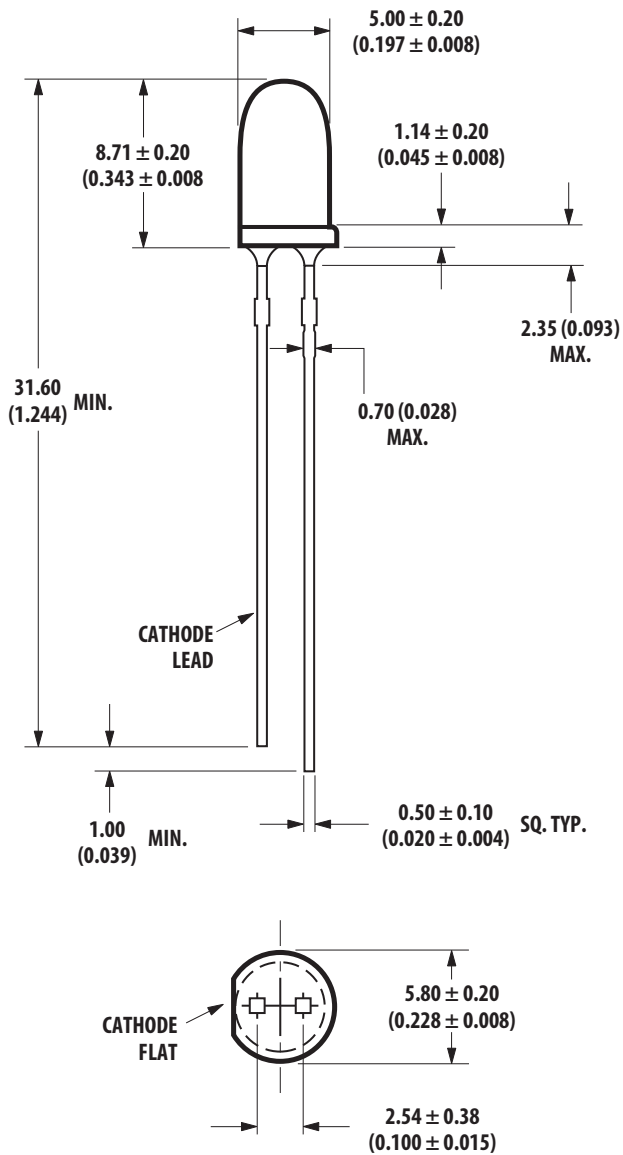

NOTE:

1. All dimensions are in millimeters (inches).
2. Tapers shown at the top of the leads (bottom of the lamp package) indicate an epoxy meniscus that may extend about 1 mm (0.40 in.) down the leads.
3. Recommended PC board hole diameters:
Lamp package without stand-offs: flush mounting at base of the lamp package = 1.143/1.067 (0.044/0.042).

Absolute Maximum Ratings at $T_A = 25^\circ\text{C}$

Parameter	Value
DC Forward Current ^{a, b, c}	50 mA
Peak Pulsed Forward Current ^{b, c}	100 mA
Average Forward Current ^c	30 mA
Reverse Voltage ($I_R = 100 \mu\text{A}$)	5V
LED Junction Temperature	130°C
Operating Temperature	-40°C to +100°C
Storage Temperature	-40°C to +100°C

- Derate linearly as shown in [Figure 4](#).
- For long term performance with minimal light output degradation, drive currents between 10 mA and 30 mA are recommended.
- Contact your Broadcom[®] sales representative about operating currents below 10 mA.

Electrical/Optical Characteristics at $T_A = 25^\circ\text{C}$

Parameter	Symbol	Min.	Typ.	Max.	Units	Test Conditions
Forward Voltage	V_F				V	$I_F = 20 \text{ mA}$
Amber ($\lambda_d = 590 \text{ nm}$)		—	2.02	2.4		
Red ($\lambda_d = 626 \text{ nm}$)		—	1.90	2.4		
Reverse Voltage	V_R	5	20	—	V	$I_R = 100 \mu\text{A}$
Peak Wavelength	λ_{PEAK}				nm	Peak of Wavelength of Spectral Distribution at $I_F = 20 \text{ mA}$
Amber ($\lambda_d = 590 \text{ nm}$)		—	592	—		
Red ($\lambda_d = 626 \text{ nm}$)		—	635	—		
Spectral Halfwidth	$\Delta\lambda_{1/2}$	—	17	—	nm	Wavelength Width at Spectral Distribution 1/2 Power Point at $I_F = 20 \text{ mA}$
Speed of Response	τ_s	—	20	—	ns	Exponential Time Constant, e^{-t/τ_s}
Capacitance	C	—	40	—	pF	$V_F = 0, f = 1 \text{ MHz}$
Thermal Resistance	$R\theta_{\text{J-PIN}}$	—	240	—	°C/W	LED Junction-to-Cathode Lead
Luminous Efficacy ^a	η_v				lm/W	Emitted Luminous Power/Emitted Radiant Power
Amber ($\lambda_d = 590 \text{ nm}$)		—	480	—		
Red ($\lambda_d = 626 \text{ nm}$)		—	150	—		

- The radiant intensity, I_e , in watts per steradian, may be found from the equation $I_e = I_v/\eta_v$, where I_v is the luminous intensity in candelas and η_v is the luminous efficacy in lumens/watt.

Part Numbering System

H L M P -

x ₁	x ₂	x ₃	x ₄
----------------	----------------	----------------	----------------

 -

x ₅	x ₆	x ₇	x ₈	x ₉
----------------	----------------	----------------	----------------	----------------

Code	Description	Option	
x ₁	Package Type	E	5mm AllnGaP Round
x ₂	Color	G	Red 626 nm
		L	Amber 590 nm
x ₃ x ₄	Viewing Angle and Lead Stand-off	55	55° without lead stand-off
x ₅	Minimum Intensity Bin	Refer to Intensity Bin Limits (CAT) table	
x ₆	Maximum Intensity Bin		
x ₇	Color Bin Option	0	Full distribution
x ₈ x ₉	Packing Option	00	Bulk packaging
		DD	Ammopack

Bin Information

Intensity Bin Limits (mcd at 20 mA)

Bin Name	Min.	Max.
G	140	180
H	180	240
J	240	310
K	310	400
L	400	520
M	520	680
N	680	880
P	880	1150

Tolerance for each bin limit is ± 15%.

Amber Color Bin Limits (nm at 20 mA)

Bin Name	Min.	Max.
1	584.5	587.0
2	587.0	589.5
4	589.5	592.0
6	592.0	594.5

Tolerance for each bin limit is ± 0.5 nm.

NOTE: Bin categories are established for classification of products. Products may not be available in all bin categories.

Figure 1: Relative Intensity vs. Peak Wavelength

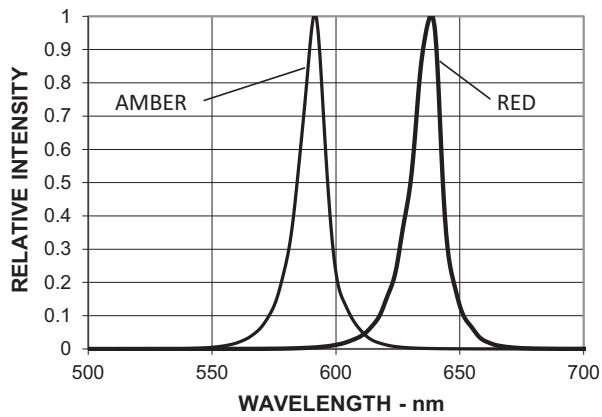

Figure 2: Forward Current vs. Forward Voltage

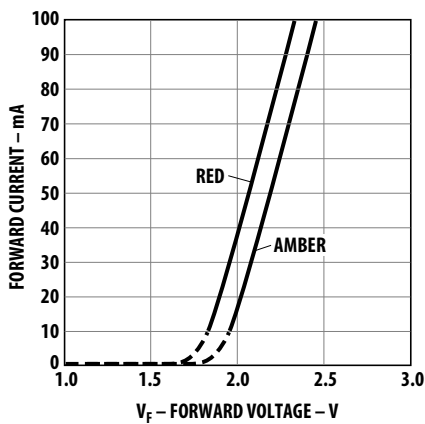

Figure 3: Relative Luminous Intensity vs. Forward Current

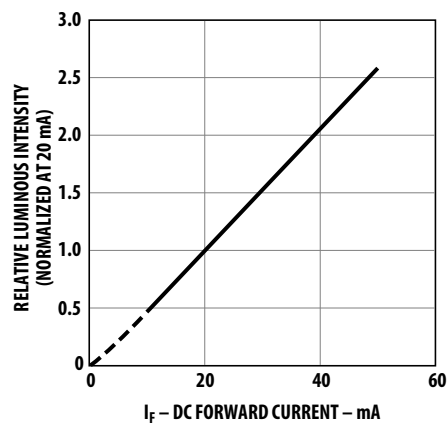

Figure 4: Maximum Forward Current vs. Ambient Temperature. Derating based on $T_{JMAX} = 130^{\circ}C$.

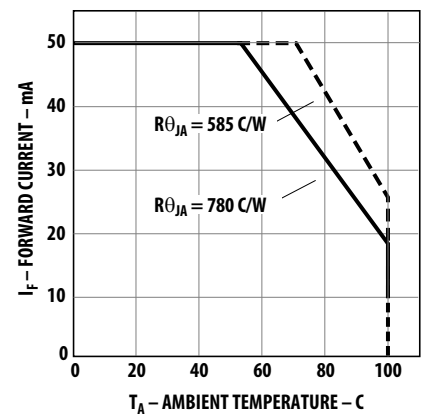
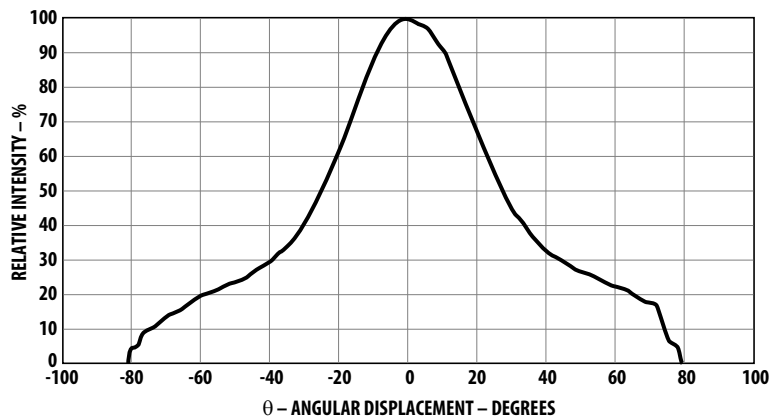

Figure 5: Representative Spatial Radiation Pattern for 55° Viewing Angle Lamps



Precautions

Lead Forming

- The leads of an LED lamp may be preformed or cut to length prior to insertion and soldering on PC board.
- For better control, use the proper tool to precisely form and cut the leads to the applicable length rather than doing it manually.
- If manual lead cutting is necessary, cut the leads after the soldering process. The solder connection forms a mechanical ground that prevents mechanical stress due to lead cutting from traveling into the LED package. Perform this action for the hand solder operation, because the excess lead length also acts as small heat sink.

Soldering and Handling

- Take care during the PCB assembly and soldering process to prevent damage to the LED component.
- LED component may be effectively hand soldered to the PCB; however, do this only under unavoidable circumstances, such as rework. The closest manual soldering distance of the soldering heat source (soldering iron's tip) to the body is 1.59 mm.

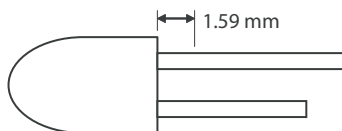

Soldering the LED using a soldering iron tip closer than 1.59 mm might damage the LED.

- Apply ESD precautions on the soldering station and personnel to prevent ESD damage to the LED component, which is ESD sensitive. Refer to Broadcom application note AN 1142 for details. Use a soldering iron used with a grounded tip to ensure that electrostatic charge is properly grounded.
- The following table shows the recommended soldering condition.

	Wave Soldering ^{a, b}	Manual Solder Dipping
Pre-heat temperature	105°C max.	—
Preheat time	60 seconds max.	—
Peak temperature	250°C max.	260°C max.
Dwell time	3 seconds max.	5 seconds max.

a. The preceding conditions refer to measurement with a thermocouple mounted at the bottom of the PCB.

b. Use only bottom preheaters to reduce thermal stress experienced by the LED.

- Set and maintain wave soldering parameters according to the recommended temperature and dwell time. Perform daily checks on the soldering profile to ensure that it always conforms to the recommended soldering conditions.

NOTE:

1. PCBs with different sizes and designs (component density) have different heat mass (heat capacity). This might cause a change in temperature experienced by the board if the same wave soldering setting is used. So, recalibrate the soldering profile again before loading a new type of PCB.
2. The Broadcom high brightness LEDs use high-efficiency LED dies with single wire bond as shown in the following figure. Take extra precautions during wave soldering to ensure that the maximum wave temperature does not exceed 250°C and the solder contact time does not exceed 3 seconds. Overstressing the LED during the soldering process might cause premature failure to the LED due to delamination.

LED Configuration

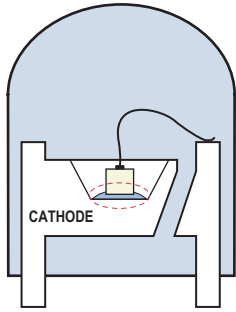

AlInGaP Device

NOTE: The electrical connection between the bottom surface of the LED die and the lead frame is achieved through conductive paste.

- Any alignment fixture that is being applied during wave soldering should be loosely fitted and should not apply weight or force on LED. Use nonmetal material because it absorbs less heat during wave soldering process.
- At elevated temperatures, LED is more susceptible to mechanical stress. Therefore, allow the PCB to cool down to room temperature prior to handling, which includes the removal of the alignment fixture or pallet.

- If PCB board contains both through-hole (TH) LED and other surface mount components, solder the surface mount components on the top side of the PCB. If surface mount must be on the bottom side, solder these components using reflow soldering prior to insertion the TH LED.
- The following table shows the recommended PC board plated through-holes (PTH) size for LED component leads.

LED Component Lead Size	Diagonal	Plated Through-Hole Diameter
0.45 × 0.45 mm (0.018 × 0.018 in.)	0.636 mm (0.025 in.)	0.98 to 1.08 mm (0.039 to 0.043 in.)
0.50 × 0.50 mm (0.020 × 0.020 in.)	0.707 mm (0.028 in.)	1.05 to 1.15 mm (0.041 to 0.045 in.)

- Oversizing the PTH can lead to a twisted LED after clinching. On the other hand, undersizing the PTH can cause difficulty inserting the TH LED.

Refer to application note AN5334 for more information about soldering and handling of high-brightness TH LED lamps.

Figure 6: Example of Wave Soldering Temperature Profile for TH LED

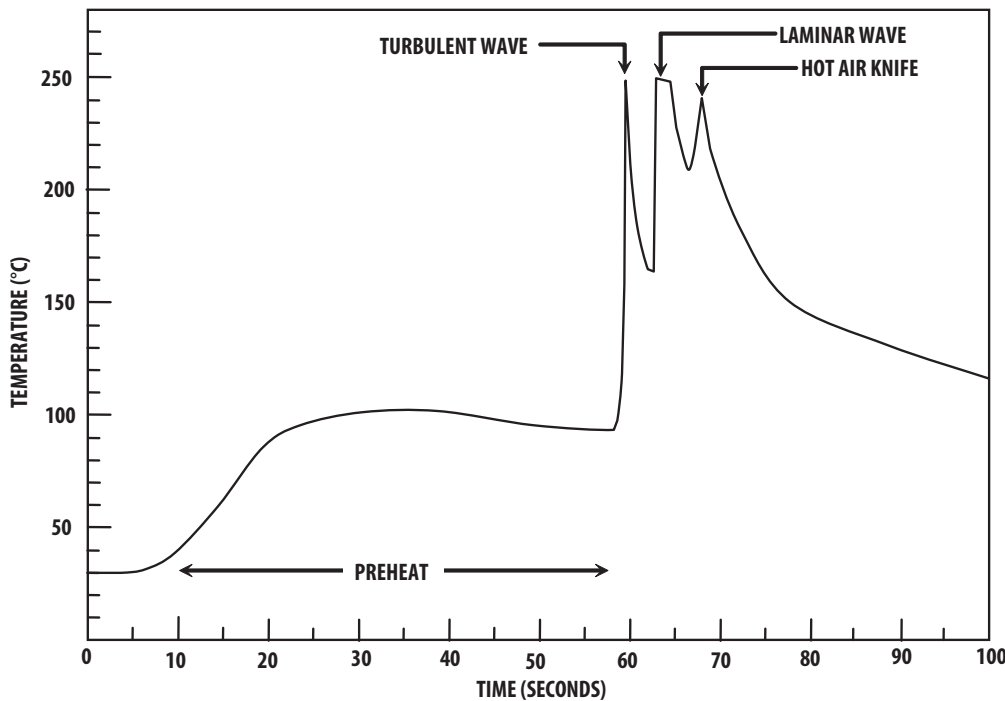

Recommended solder:
Sn63 (Leaded solder alloy)
SAC305 (Lead free solder alloy)

Flux: Rosin flux

Solder bath temperature:
245°C ± 5°C (maximum peak temperature = 250°C)

Dwell time: 1.5 sec - 3.0 sec (maximum = 3sec)

Note: Allow for board to be sufficiently cooled to room temperature before exerting mechanical force.

Ammo Pack Drawing

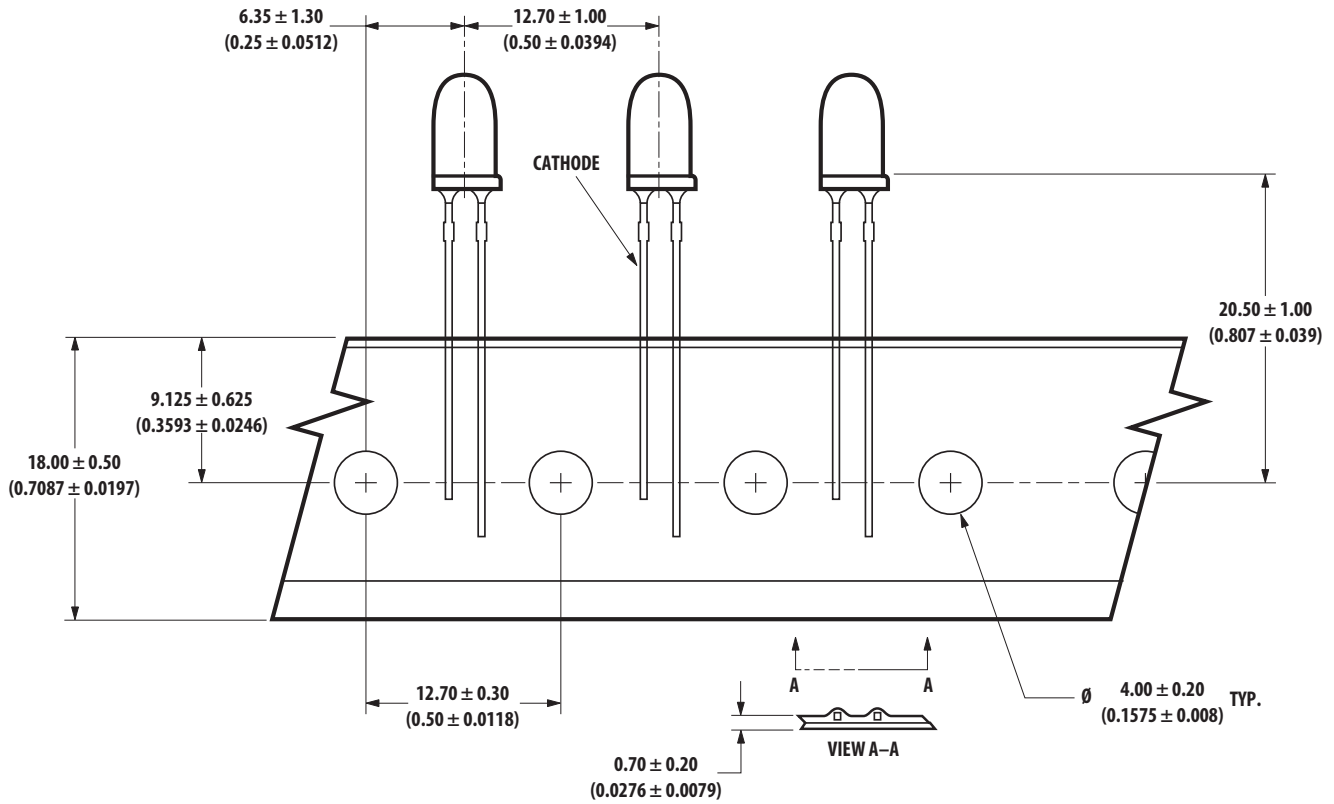

ALL DIMENSIONS IN MILLIMETERS (INCHES).

NOTE: THE AMMO-PACKS DRAWING IS APPLICABLE FOR PACKAGING OPTION -DD & -ZZ AND REGARDLESS OF STANDOFF OR NON-STANDOFF.



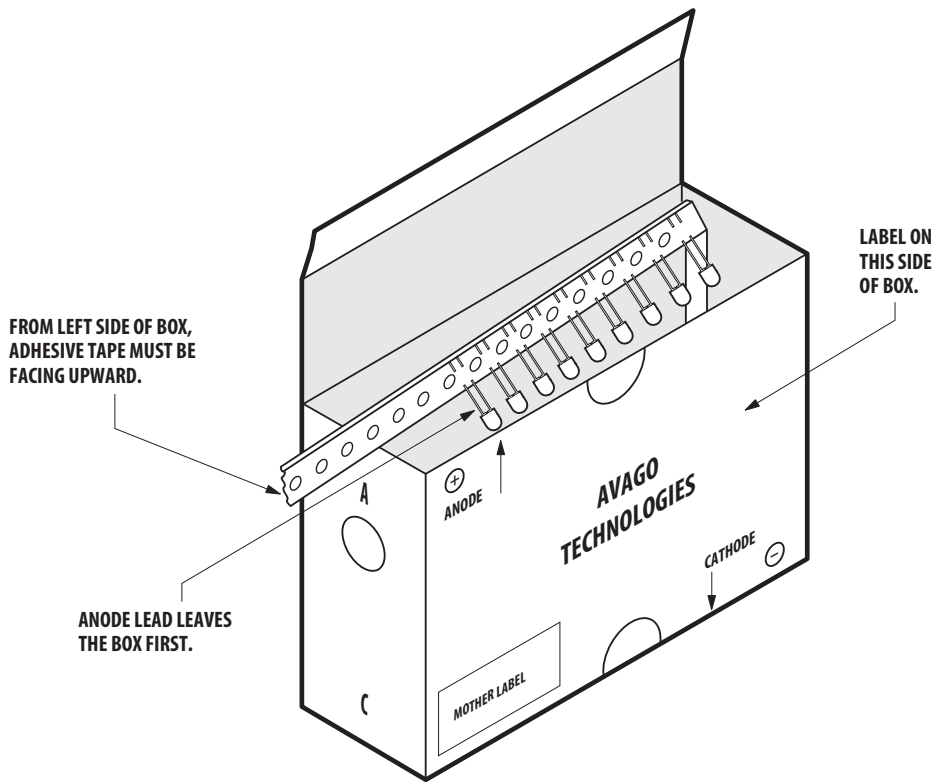







Packaging Box for Ammo Packs



NOTE: THE DIMENSION FOR AMMO PACK IS APPLICABLE FOR THE DEVICE WITH STANDOFF AND WITHOUT STANDOFF.

Packaging Label

(i) Mother Label: (Available on packaging box of ammo pack and shipping box)

AVAGO TECHNOLOGIES	
(1P) Item: Part Number 	STANDARD LABEL LS0002 RoHS Compliant e3 max temp 250C
(1T) Lot: Lot Number 	(Q) QTY: Quantity 
LPN: 	CAT: Intensity Bin 
(9D)MFG Date: Manufacturing Date 	BIN: Refer to below information
<hr/>	
(P) Customer Item: 	
(V) Vendor ID: 	(9D) Date Code: Date Code 
DeptID: 	Made In: Country of Origin 

(ii) Baby Label (Only available on bulk packaging)

AVAGO TECHNOLOGIES	
Lamps Baby Label	
RoHS Compliant e3 max temp 250C	
(1P) PART #: Part Number 	
(1T) LOT #: Lot Number 	
(9D)MFG DATE: Manufacturing Date 	QUANTITY: Packing Quantity 
C/O: Country of Origin	
<hr/>	
Customer P/N: 	CAT: Intensity Bin 
Supplier Code: 	BIN: Refer to below information 
	DATECODE: Date Code 

Acronyms and Definition

BIN:

- (i) Color bin only or VF bin only
(Applicable for part number with color bins but without VF bin OR part number with VF bins and no color bin)

OR

- (ii) Color bin incorporated with VF Bin
(Applicable for part number that have both color bin and VF bin)

Example:

- (i) Color bin only or VF bin only
BIN: 2 (represent color bin 2 only)
BIN: VB (represent VF bin "VB" only)
- (ii) Color bin incorporate with VF Bin
BIN: 2VB
2: Color bin 2 only
VB: VF bin "VB"

Disclaimer

Broadcom products and software are not specifically designed, manufactured, or authorized for sale as parts, components, or assemblies for the planning, construction, maintenance, or direct operation of a nuclear facility or for use in medical devices or applications. The customer is solely responsible, and waives all rights to make claims against Broadcom or its suppliers, for all loss, damage, expense, or liability in connection with such use.

Broadcom, the pulse logo, Connecting everything, Avago Technologies, Avago, and the A logo are among the trademarks of Broadcom and/or its affiliates in the United States, certain other countries, and/or the EU.

Copyright © 2014–2021 Broadcom. All Rights Reserved.

The term “Broadcom” refers to Broadcom Inc. and/or its subsidiaries. For more information, please visit www.broadcom.com.

Broadcom reserves the right to make changes without further notice to any products or data herein to improve reliability, function, or design. Information furnished by Broadcom is believed to be accurate and reliable. However, Broadcom does not assume any liability arising out of the application or use of this information, nor the application or use of any product or circuit described herein, neither does it convey any license under its patent rights nor the rights of others.



Lead (Pb) Free
RoHS Compliant