

**MODEL:** SJ-63023H | **DESCRIPTION:** AUDIO JACK**FEATURES**

- panel mount
- 3 conductor
- 2 isolated switches
- threaded with nut

**SPECIFICATIONS**

parameter	conditions/description	min	typ	max	units
rated input voltage			12		Vdc
rated input current				1	A
contact resistance	between terminal and mating plug			30	mΩ
insulation resistance	at 500 Vdc	100			MΩ
voltage withstand	for 1 minute			500	Vac
insertion/withdrawal force		0.4		3	kg
operating temperature		-25		70	°C
life			5,000		cycles
flammability rating	see material table				
RoHS	yes				

**SOLDERABILITY**

parameter	conditions/description	min	typ	max	units
hand soldering	for 3~5 seconds		360		°C

## MECHANICAL DRAWING

units: mm  
tolerance: ±0.3 mm

ITEM	DESCRIPTION	MATERIAL	PLATING/COLOR
1	transfer terminal	phosphor bronze	silver
2	break terminal	brass	silver
3	tip spring	phosphor bronze	silver
4	transfer terminal	phosphor bronze	silver
5	break terminal	brass	silver
6	ring spring	phosphor bronze	silver
7	housing	POM (UL94HB)	black
8	cover	steel	nickel
9	barrel	brass	nickel
10	insulator	vulcanized fiber	red
11	insulator	POM (UL94HB)	ivory
12	nut	steel	nickel
13	washer	steel	nickel

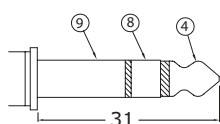
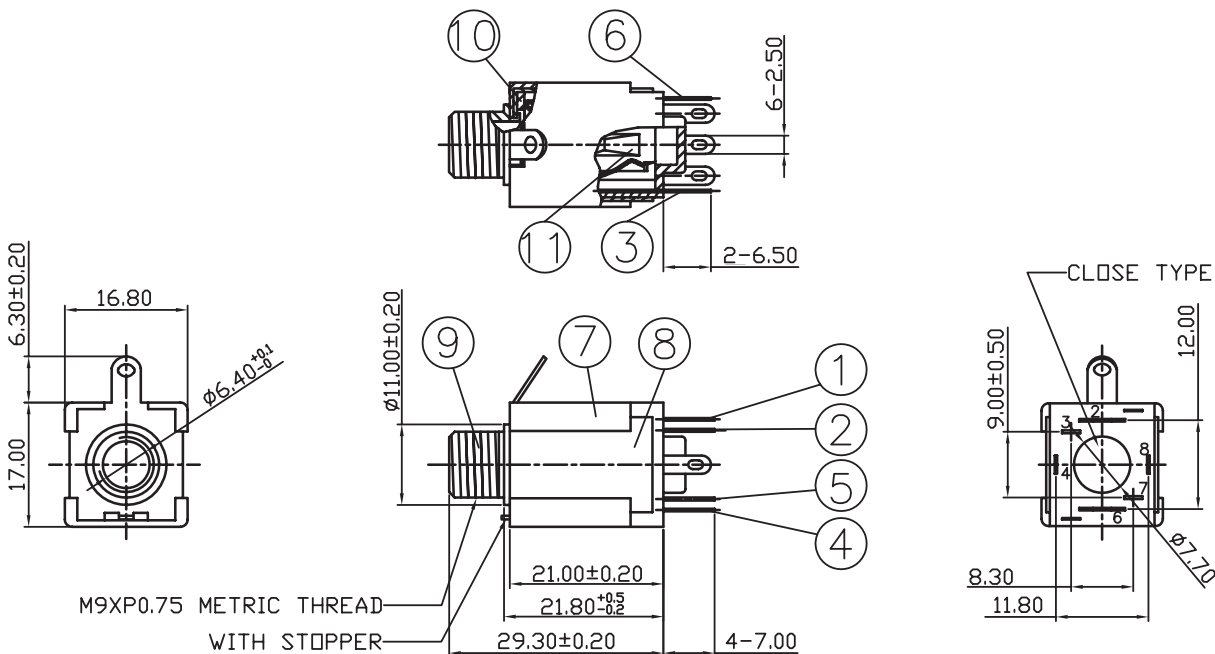

Ø6.3 MATING PLUG

Model No.	SJ-63023H
Schematic	
PIN	
2	isolated transfer terminal 1
3	isolated break terminal 1 (N-C)
4	tip
6	isolated transfer terminal 2
7	isolated break terminal 2 (N-C)
8	ring
9	sleeve

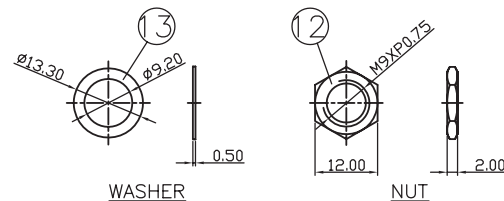

## REVISION HISTORY

---

rev.	description	date
1.0	initial release	07/30/2020

The revision history provided is for informational purposes only and is believed to be accurate.

---

# CUI DEVICES

CUI Devices offers a one (1) year limited warranty. Complete warranty information is listed on our website.

CUI Devices reserves the right to make changes to the product at any time without notice. Information provided by CUI Devices is believed to be accurate and reliable. However, no responsibility is assumed by CUI Devices for its use, nor for any infringements of patents or other rights of third parties which may result from its use.

CUI Devices products are not authorized or warranted for use as critical components in equipment that requires an extremely high level of reliability. A critical component is any component of a life support device or system whose failure to perform can be reasonably expected to cause the failure of the life support device or system, or to affect its safety or effectiveness.