

## ASMT-Jx1x

### 1W Mini Power LED Light Source



### Description

This Broadcom<sup>®</sup> 1W Mini Power LED Light Source is a high-performance energy-efficient device that can handle high thermal and high driving current. An option with an electrically isolated metal slug is also available.

The White Mini Power LED is available in the range of color temperatures from 2700K to 10,000K.

The low-profile package design and ultra small footprint is suitable for a wide variety of applications especially where space and height is a constraint.

The package is compatible with reflow soldering process. To facilitate easy pick-and-place assembly, the LEDs are packed in EIA-compliant tape and reel.

### Features

- Available in red, amber, blue, royal blue, cyan, green, cool white, and neutral white
- Small footprint
- Energy efficient
- Direct heat transfer from metal slug to motherboard
- Compatible with reflow soldering process
- High current operation
- Long operation life
- Wide viewing angle
- Silicone encapsulation
- Non-ESD sensitive (threshold > 16 kV)
- MSL 1 products

### Applications

- Architectural lighting
- Garden lighting
- Decorative lighting
- Sign backlight
- Safety, exit and emergency sign lightings
- Specialty lighting such as task lighting and reading lights
- Retail display
- Commercial lighting
- Accent or marker lightings, strip, or step lightings
- Portable lightings, bicycle head lamp, torch lights
- Pathway lighting
- Street lighting
- Tunnel lighting

**CAUTION!** Keep the LEDs in the MBB when not in use because prolonged exposure to environment might cause the silver plated leads to tarnish, which might cause difficulties in soldering.

Figure 1: ASMT-Jx1x Package Outline Drawing

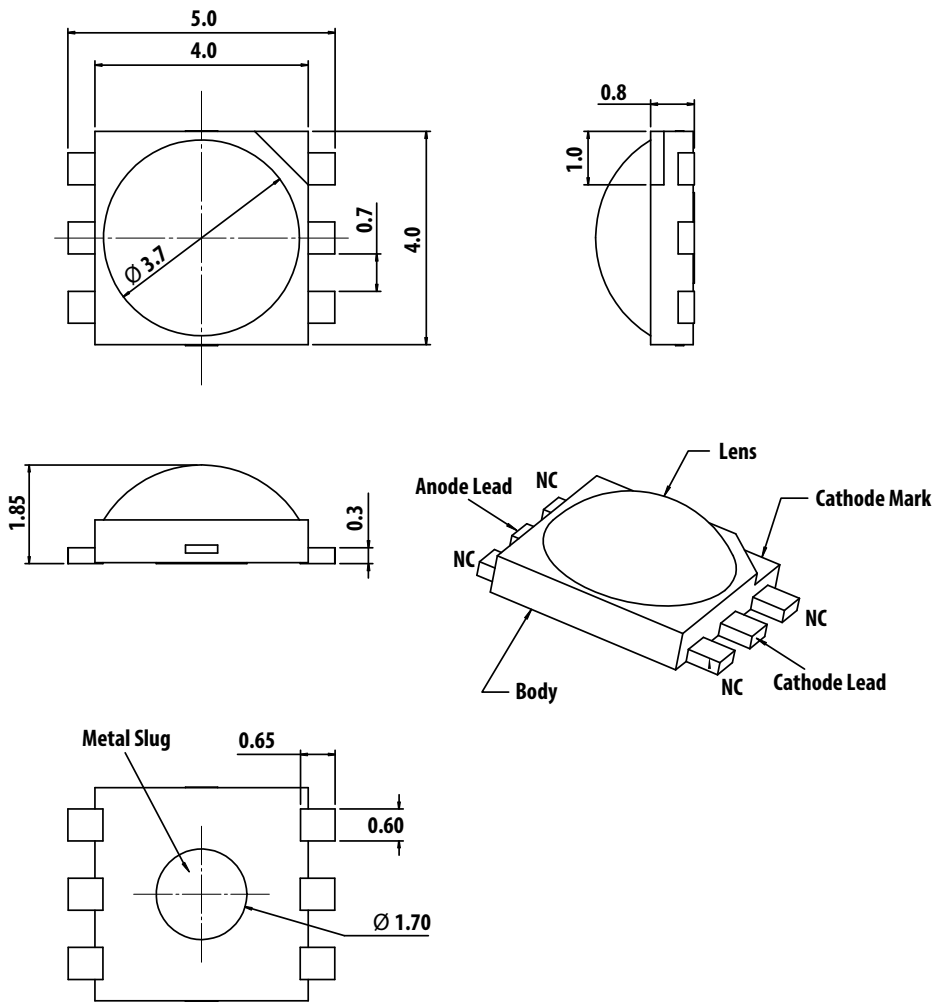
**NOTE:**

1. All dimensions are in millimeters.
2. Metal slug is connected to anode for electrically non-isolated option.
3. Tolerance is  $\pm 0.1$  mm unless otherwise specified.
4. Terminal finish: Ag plating.
5. Corresponding NC (No Connection) leads adjacent to anode and cathode leads can be electrically short.

## Device Selection Guide ( $T_J = 25^\circ\text{C}$ )

Part Number	Color	Luminous Flux (lm) / Radiometric Power (mW), $\Phi_V$ <sup>a, b</sup>			Test Current (mA)	Dice Technology	Electrically Isolated Metal Slug
		Min.	Typ.	Max.			
ASMT-JR10-AST01	Red	51.7	62.0	87.4	350	AllnGaP	No
ASMT-JA10-ARS01	Amber	39.8	48.0	67.2	350	AllnGaP	No
ASMT-JB11-NNQ01	Blue	18.1	24.0	39.8	350	InGaN	Yes
ASMT-JL11-NQS01	Royal Blue	435 mW	550 mW	685 mW	350	InGaN	Yes
ASMT-JC11-NTU01	Cyan	67.2	75.0	99.6	350	InGaN	Yes
ASMT-JG11-NUW01	Green	87.4	110.0	129.5	350	InGaN	Yes
ASMT-JW11-NWX01	Cool White	113.6	120.0	147.7	350	InGaN	Yes
ASMT-JN11-NWX01	Neutral White	113.6	120.0	147.7	350	InGaN	Yes

a.  $\Phi_V$  is the total luminous flux/radiometric power output as measured with an integrating sphere at 25-ms mono pulse condition.

b. Flux tolerance is  $\pm 10\%$ .

## Absolute Maximum Ratings

Parameter	AllnGaP	InGaN	InGaN Cyan	Units
DC Forward Current <sup>a</sup>	500	500	500	mA
Peak Pulsing Current <sup>b</sup>	1000	1000	1000	mA
Power Dissipation	1230	1830	1980	mW
LED Junction Temperature	125	150	150	$^\circ\text{C}$
Operating Metal Slug Temperature Range at 350 mA	-40 to +115	-40 to +135	-40 to +135	$^\circ\text{C}$
Storage Temperature Range	-40 to +120	-40 to +120	-40 to +120	$^\circ\text{C}$
Soldering Temperature	See <a href="#">Figure 28</a>			
Reverse Voltage <sup>c</sup>	Not recommended			

a. Derate linearly based on [Figure 12](#) and [Figure 13](#) for AllnGaP and [Figure 24](#) and [Figure 25](#) for InGaN.

b. Pulse condition duty factor = 10%, frequency = 1 kHz.

c. Not recommended for reverse bias operation.

## Optical Characteristics at 350 mA ( $T_J = 25^\circ\text{C}$ )

Part Number	Color	Peak Wavelength, $\lambda_{\text{PEAK}}$ (nm)	Dominant Wavelength, $\lambda_D^a$ (nm)	Viewing Angle, $2\theta_{1/2}^b$ (°)	Luminous Efficiency (lm/W)
		Typ.	Typ.	Typ.	Typ.
ASMT-JR10-AST01	Red	635	625	165	84
ASMT-JA10-ARS01	Amber	598	590	165	65
ASMT-JG11-NUW01	Green	519	525	165	98
ASMT-JC11-NTU01	Cyan	497	500	165	63
ASMT-JB11-NNQ01	Blue	454	460	165	21
ASMT-JL11-NQS01	Royal Blue	450	455	165	Not applicable

a. The dominant wavelength,  $\lambda_D$ , is derived from the CIE Chromaticity Diagram and represents the color of the device.

b.  $\theta_{1/2}$  is the off-axis angle where the luminous intensity is half of the peak intensity.

Part Number	Color	Correlated Color Temperature, CCT (Kelvin)		Viewing Angle, $2\theta_{1/2}^a$ (°)	Luminous Efficiency (lm/W)
		Min.	Max.	Typ.	Typ.
ASMT-JW11-NWX01	Cool White	4500	10000	140	107
ASMT-JN11-NWX01	Neutral White	3500	4500	140	107

a.  $\theta_{1/2}$  is the off-axis angle where the luminous intensity is half of the peak intensity.

## Electrical Characteristic at 350 mA ( $T_J = 25^\circ\text{C}$ )

Dice Type	Forward Voltage, $V_F$ (Volts)			Thermal Resistance, $R_{\theta j-ms}$ ( $^\circ\text{C}/\text{W}$ ) <sup>a</sup>
	Min.	Typ.	Max.	Typ.
AllnGaP	1.7	2.1	2.3	9
InGaN (non-Cyan Colors)	2.8	3.2	3.5	9
InGaN Cyan	2.6	3.0	3.8	9

a.  $R_{\theta j-ms}$  is thermal resistance from LED junction to metal slug.

## Part Numbering System

A S M T - J x<sub>1</sub> 1 x<sub>2</sub> - x<sub>3</sub> x<sub>4</sub> x<sub>5</sub> x<sub>6</sub> x<sub>7</sub>

Code	Description	Option	
x <sub>1</sub>	Color	R	Red
		A	Amber
		G	Green
		B	Blue
		L	Royal Blue
		W	Cool White
		N	Neutral White
x <sub>2</sub>	Heat sink	0	Electrically Non Isolated
		1	Electrically Isolated
x <sub>3</sub>	Dice Type	N	InGaN
		A	AllnGaP
x <sub>4</sub>	Minimum Flux Bin	See <a href="#">Flux/Power Bin Limit (x<sub>4</sub>, x<sub>5</sub>)</a>	
x <sub>5</sub>	Maximum Flux Bin		
x <sub>6</sub>	Color Bin Selection	See <a href="#">Color Bin Selection (x<sub>6</sub>)</a>	
x <sub>7</sub>	Packaging Option	0	Tube
		1	Tape and Reel

## Bin Information

### Flux/Power Bin Limit (x<sub>4</sub>, x<sub>5</sub>)

Color	Bin ID	Luminous Flux (lm)/Radiometric Power (mW) at 350 mA	
		Min.	Max.
Blue	M	13.9	18.1
	N	18.1	23.5
	P	23.5	30.6
	Q	30.6	39.8
Other Colors	R	39.8	51.7
	S	51.7	67.2
	T	67.2	87.4
	U	87.4	99.6
	V	99.6	113.6
	W	113.6	129.5
	X	129.5	147.7
Royal Blue	M	225.0	275.0
	N	275.0	355.0
	P	355.0	435.0
	Q	435.0	515.0
	R	515.0	595.0
	S	595.0	685.0

Tolerance for each bin limit is  $\pm 10\%$ .

## Color Bin Selection (x<sub>6</sub>)

Individual reel will contain parts from one color bin selection only.

### Cool White

Selection	Bin ID
0	Full Distribution
E	VM, UM, VN, and UN
F	WM, VM, WN, and VN
G	XM, WM, XN, and WN
H	UN, VN, U0, and V0
J	WN, VN, W0, and V0
K	XN, WN, X0, and W0
L	V0, U0, VP, and UP
M	W0, V0, WP, VP, and WQ
N	X0, W0, XP, WP, and WQ
P	Y0
Q	YA

### Neutral White

Selection	Bin ID
0	Full Distribution
E	SM, RM, S1, and R1
F	TM, SM, TN, and S1
G	S1, R1, S0, and R0
H	TN, S1, T0, and S0
J	S0, R0, SA, and RA
K	T0, S0, TP, and SA

### Other Colors

Selection	Bin ID
0	Full Distribution
Z	A and B
Y	B and C
W	C and D
V	D and E
Q	A, B, and C
P	B, C, and D
N	C, D, and E
M	D, E, and F

Figure 2: Color Bin Structure for Cool White

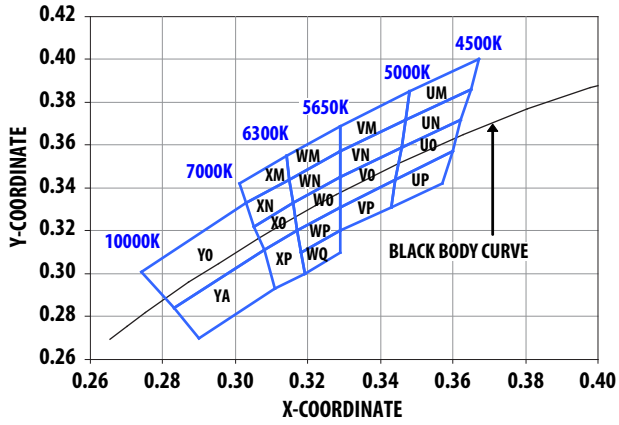
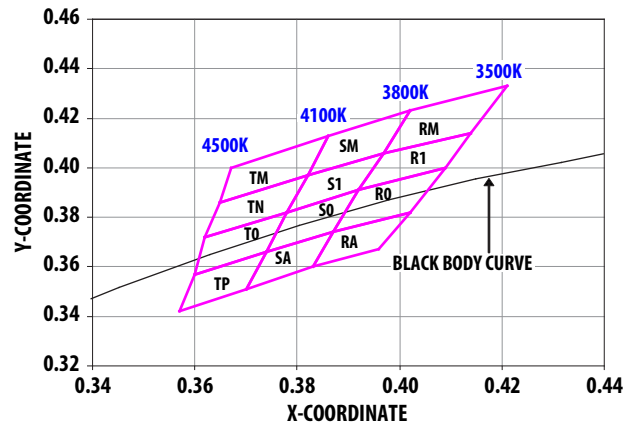

Figure 3: Color Bin Structure for Neutral White



## Color Bin Limits

Cool White	Color Limits (Chromaticity Coordinates)				
Bin UM	x	0.365	0.348	0.347	0.367
	y	0.386	0.385	0.372	0.400
Bin UN	x	0.365	0.362	0.346	0.347
	y	0.386	0.372	0.359	0.372
Bin U0	x	0.362	0.360	0.344	0.346
	y	0.372	0.357	0.344	0.359
Bin UP	x	0.360	0.357	0.343	0.344
	y	0.357	0.342	0.311	0.344
Bin VM	x	0.329	0.329	0.348	0.347
	y	0.357	0.369	0.385	0.372
Bin VN	x	0.329	0.329	0.347	0.346
	y	0.345	0.357	0.372	0.359
Bin V0	x	0.329	0.329	0.346	0.344
	y	0.331	0.345	0.359	0.344
Bin VP	x	0.329	0.344	0.343	0.329
	y	0.331	0.344	0.331	0.320
Bin WM	x	0.329	0.329	0.315	0.314
	y	0.369	0.357	0.344	0.355
Bin WN	x	0.329	0.316	0.315	0.329
	y	0.345	0.333	0.344	0.357
Bin W0	x	0.329	0.329	0.317	0.316
	y	0.345	0.331	0.320	0.333
Bin WP	x	0.329	0.329	0.318	0.317
	y	0.331	0.320	0.310	0.320
Bin WQ	x	0.329	0.329	0.319	0.318
	y	0.320	0.310	0.300	0.310
Bin XM	x	0.301	0.314	0.315	0.303
	y	0.342	0.355	0.344	0.333
Bin XN	x	0.305	0.303	0.315	0.316
	y	0.322	0.333	0.344	0.333
Bin X0	x	0.308	0.305	0.316	0.317
	y	0.311	0.322	0.333	0.320
Bin XP	x	0.308	0.317	0.319	0.311
	y	0.311	0.320	0.300	0.293
Bin Y0	x	0.308	0.283	0.274	0.303
	y	0.311	0.284	0.301	0.333
Bin YA	x	0.308	0.311	0.290	0.283
	y	0.311	0.293	0.270	0.284

Tolerance:  $\pm 0.01$ .

Neutral White	Color Limits (Chromaticity Coordinates)				
Bin RM	x	0.421	0.414	0.397	0.402
	y	0.433	0.414	0.406	0.423
Bin R1	x	0.414	0.409	0.392	0.397
	y	0.414	0.400	0.391	0.406
Bin R0	x	0.392	0.387	0.402	0.409
	y	0.391	0.374	0.382	0.400
Bin RA	x	0.387	0.383	0.396	0.402
	y	0.374	0.360	0.367	0.382
Bin SM	x	0.402	0.397	0.382	0.386
	y	0.423	0.406	0.397	0.413
Bin S1	x	0.397	0.392	0.378	0.382
	y	0.406	0.391	0.382	0.397
Bin S0	x	0.392	0.387	0.374	0.378
	y	0.391	0.374	0.366	0.382
Bin SA	x	0.387	0.383	0.370	0.374
	y	0.374	0.360	0.351	0.366
Bin TM	x	0.386	0.382	0.365	0.367
	y	0.413	0.397	0.386	0.400
Bin TN	x	0.382	0.378	0.362	0.365
	y	0.397	0.382	0.372	0.386
Bin T0	x	0.378	0.374	0.360	0.362
	y	0.382	0.366	0.357	0.372
Bin TP	x	0.374	0.370	0.357	0.360
	y	0.366	0.351	0.342	0.357

Tolerance:  $\pm 0.01$ .



## Packaging Option (x<sub>7</sub>)

Selection	Option
1	Tape and Reel

Color	Bin ID	Dominant Wavelength (nm) at 350 mA	
		Min.	Max.
Red	—	620.0	635.0
Amber	B	587.0	589.5
	C	589.5	592.0
	D	592.0	594.5
	E	594.5	597.0
Blue	A	455.0	460.0
	B	460.0	465.0
	C	465.0	470.0
	D	470.0	475.0
Cyan	C	490.0	495.0
	D	495.0	500.0
	E	500.0	505.0
	F	505.0	510.0
	G	510.0	515.0
	H	515.0	520.0
Green	A	515.0	520.0
	B	520.0	525.0
	C	525.0	530.0
	D	530.0	535.0

Tolerance: ± 1 nm.

Color	Bin ID	Peak Wavelength (nm) at 350 mA	
		Min.	Max.
Royal Blue	C	440.0	445.0
	D	445.0	450.0
	E	450.0	455.0
	F	455.0	460.0

Tolerance: ± 2 nm.

## Example

### ASMT-JW11-NWX01

ASMT-JW11-Nxxxx – Cool White, InGaN, Electrically isolated Heat Sink

- X<sub>4</sub> = W – Minimum Flux Bin W
- X<sub>5</sub> = X – Maximum Flux Bin X
- X<sub>6</sub> = 0 – Full Distribution
- X<sub>7</sub> = 1 – Tape and Reel Option

# AlInGaP

Figure 4: Relative Intensity vs. Wavelength for Red and Amber

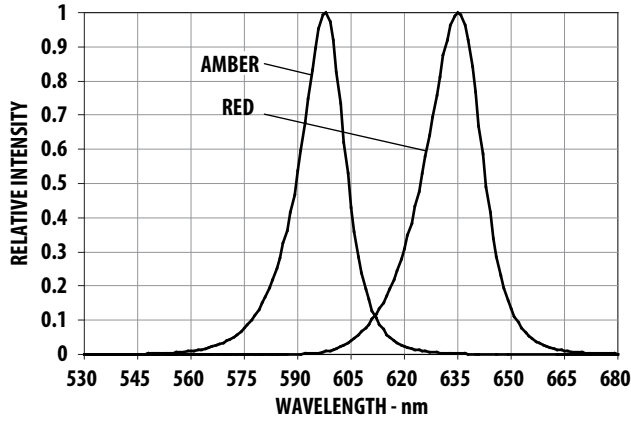

Figure 5: Relative Luminous Flux vs. Mono Pulse Current

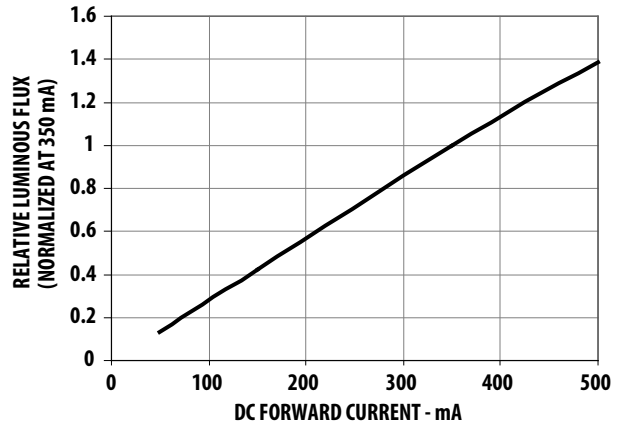

Figure 6: Forward Current vs. Forward Voltage

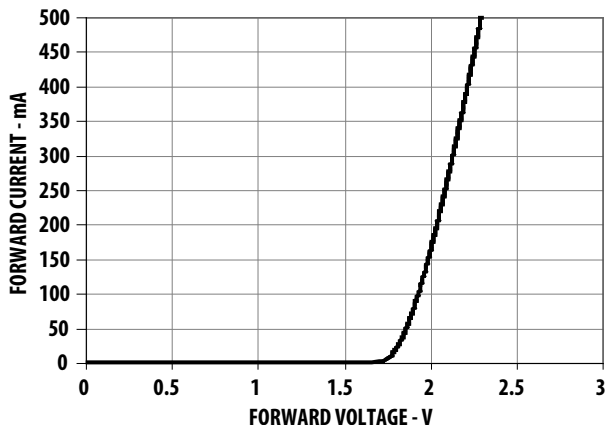

Figure 7: Radiation Pattern for Red and Amber

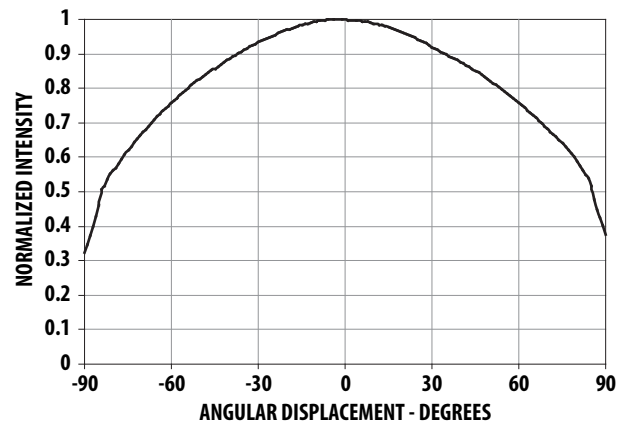

Figure 8: Maximum Pulse Current vs. Ambient Temperature. Derated based on  $T_A = 25^\circ\text{C}$ ,  $R_{\theta J-A} = 50^\circ\text{C/W}$ .

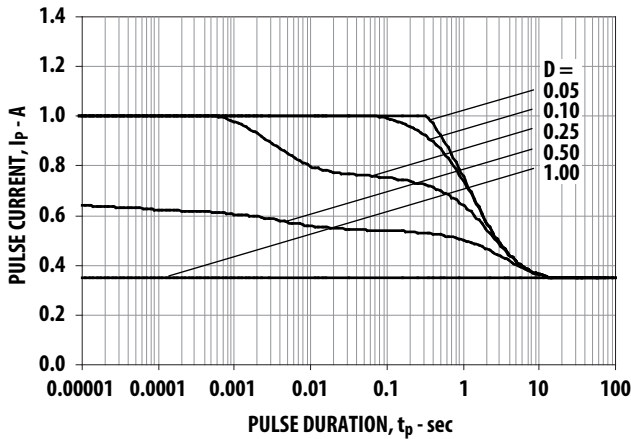
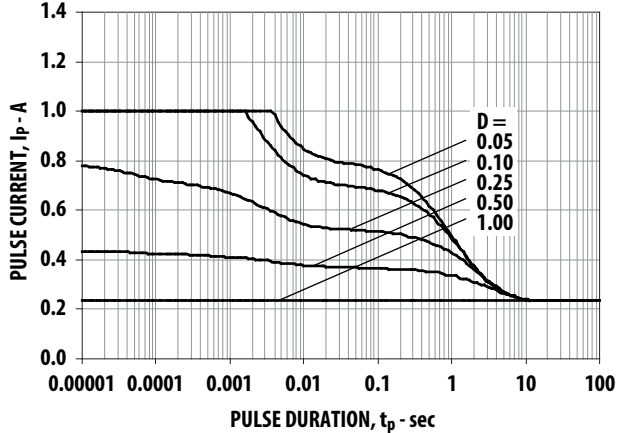

Figure 9: Maximum Pulse Current vs. Ambient Temperature. Derated based on  $T_A = 85^\circ\text{C}$ ,  $R_{\theta J-A} = 50^\circ\text{C/W}$ .



# AlInGaP

Figure 10: Relative Light Output vs. Junction Temperature

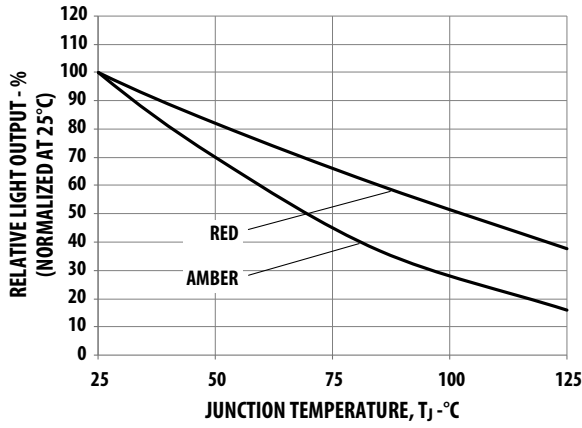

Figure 11: Forward Voltage Shift vs. Junction Temperature

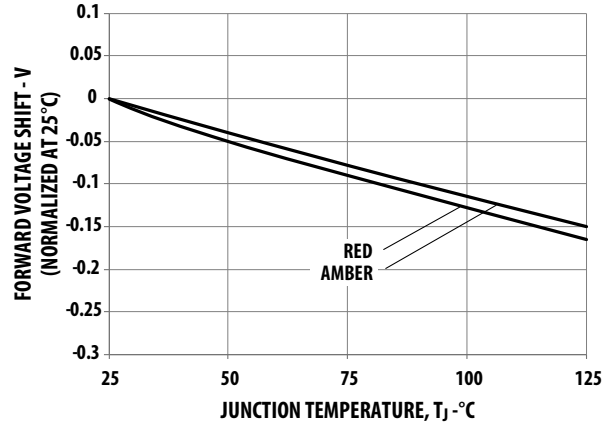

Figure 12: Maximum Forward Current vs. Ambient Temperature. Derated based on  $T_{JMAX} = 125^\circ\text{C}$ ,  $R_{\theta J-A} = 30^\circ\text{C/W}$ ,  $40^\circ\text{C/W}$ , and  $50^\circ\text{C/W}$ .

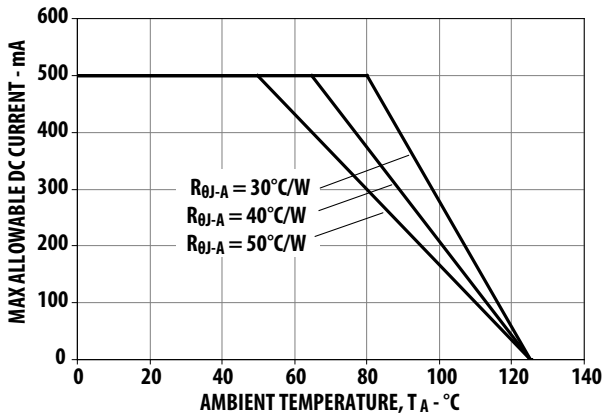
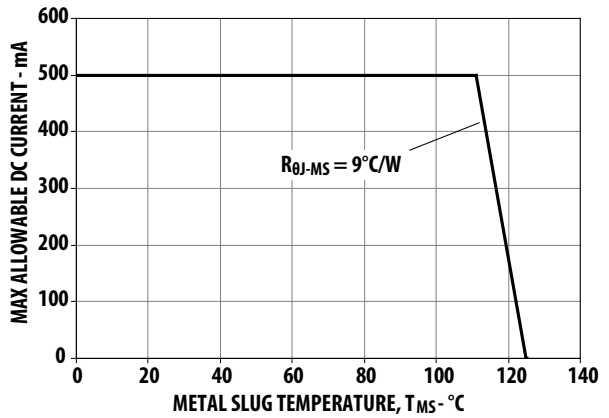

Figure 13: Maximum Forward Current vs. Metal Slug Temperature. Derated based on  $T_{JMAX} = 125^\circ\text{C}$ ,  $R_{\theta J-MS} = 9^\circ\text{C/W}$ .



# InGaN

Figure 14: Relative Intensity vs. Wavelength for Cool and Neutral White

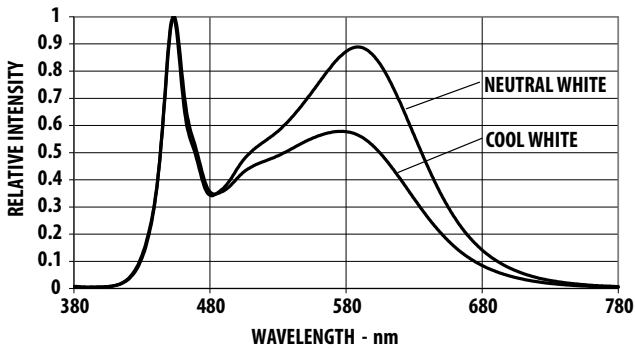

Figure 15: Relative Intensity vs. Wavelength for Blue, Royal Blue, Cyan, and Green

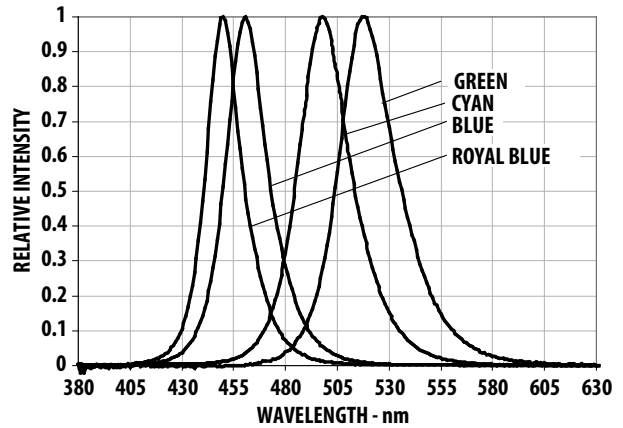

Figure 16: Relative Luminous Flux vs. Mono Pulse Current

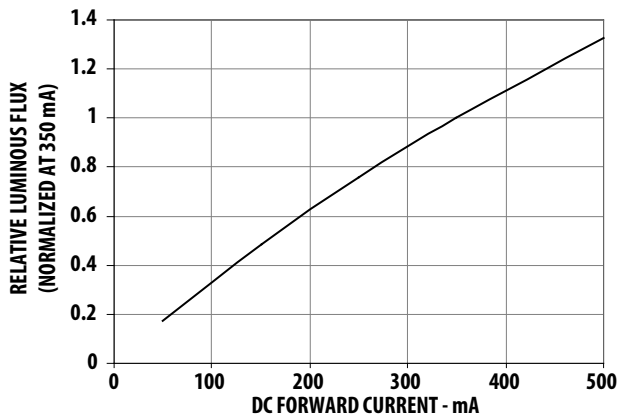

Figure 17: Forward Current vs. Forward Voltage

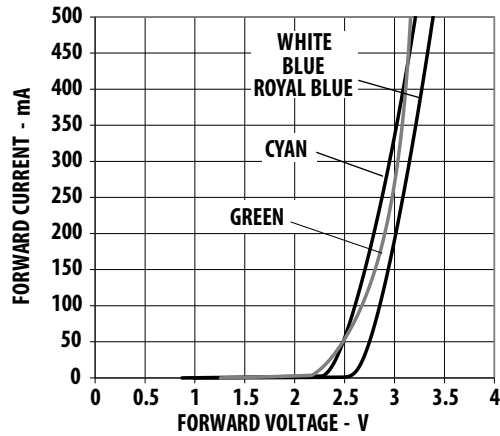

Figure 18: Radiation Pattern for Blue, Royal Blue, Cyan, and Green

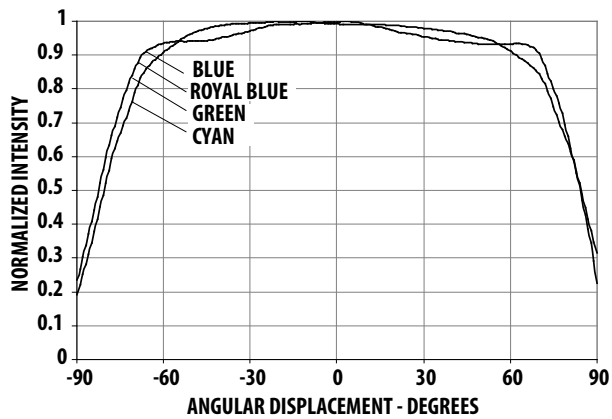
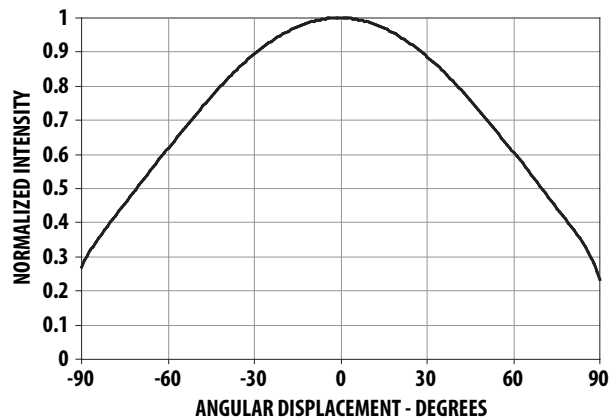

Figure 19: Radiation Pattern for Cool White and Neutral White



# InGaN

Figure 20: Maximum Pulse Current vs. Ambient Temperature. Derated based on  $T_A = 25^\circ\text{C}$ ,  $R_{\theta J-A} = 50^\circ\text{C/W}$ .

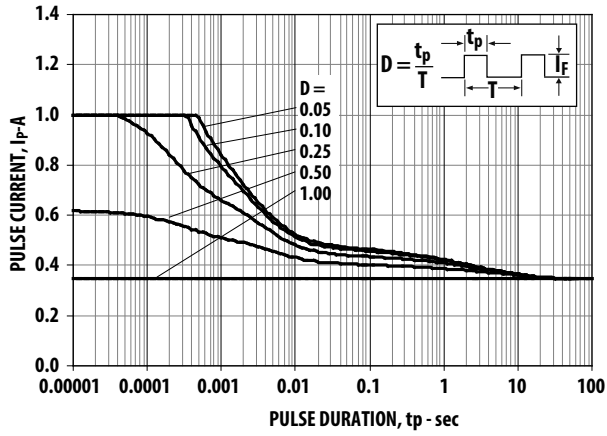

Figure 22: Relative Light Output vs. Junction Temperature

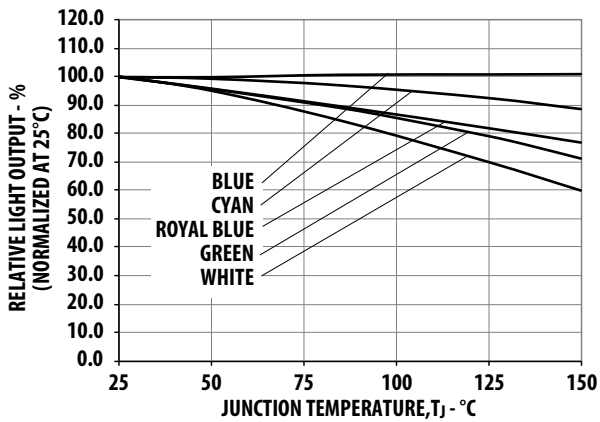

Figure 24: Maximum Forward Current vs. Ambient Temperature. Derated based on  $T_{JMAX} = 150^\circ\text{C}$ ,  $R_{\theta J-A} = 30^\circ\text{C/W}$ ,  $40^\circ\text{C/W}$  and  $50^\circ\text{C/W}$ .

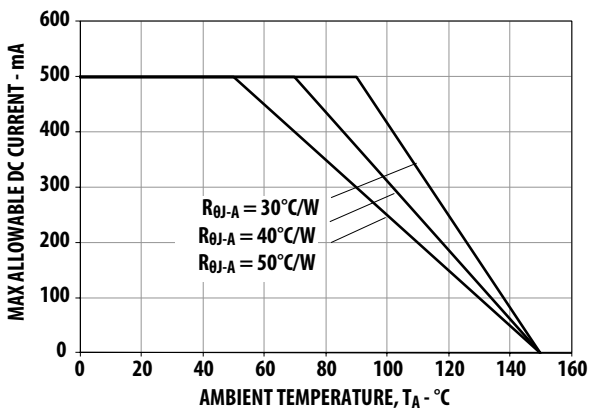

Figure 21: Maximum Pulse Current vs. Ambient Temperature. Derated based on  $T_A = 85^\circ\text{C}$ ,  $R_{\theta J-A} = 50^\circ\text{C/W}$ .

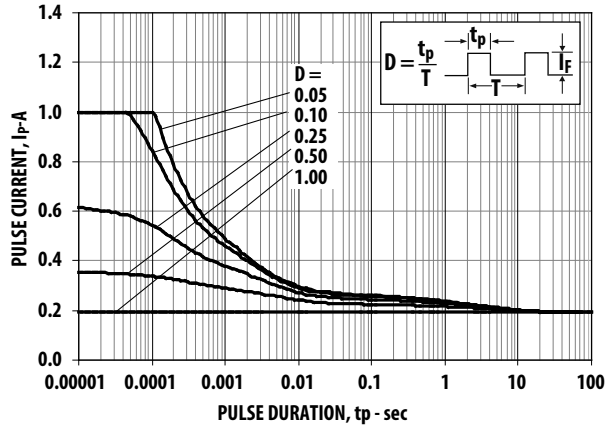

Figure 23: Forward Voltage Shift vs. Junction Temperature

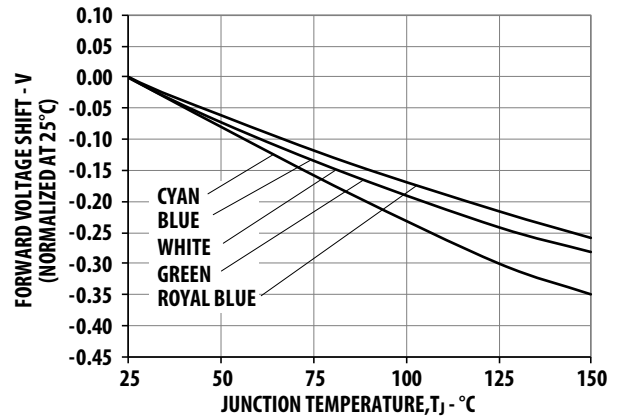
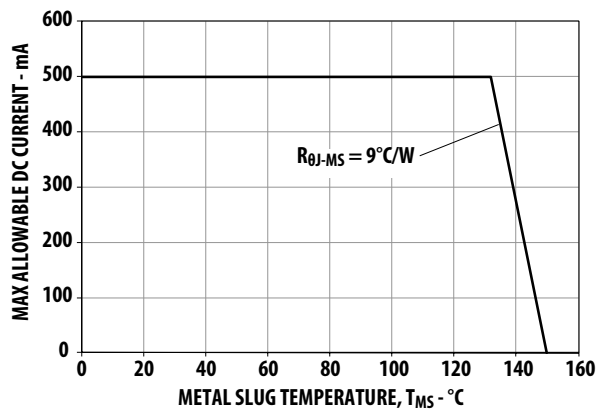
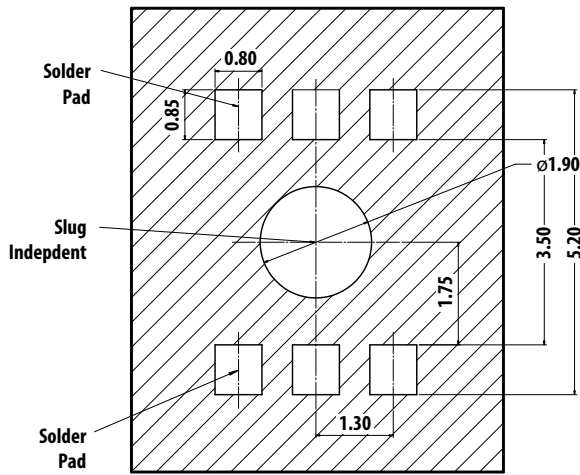

Figure 25: Maximum Forward Current vs. Metal Slug Temperature. Derated based on  $T_{JMAX} = 150^\circ\text{C}$ ,  $R_{\theta J-MS} = 9^\circ\text{C/W}$ .



**Figure 26: Recommended Soldering Land Pattern**



**Figure 27: Recommended Pick and Place Nozzle Tip. Inner diameter = 3.2 mm.**

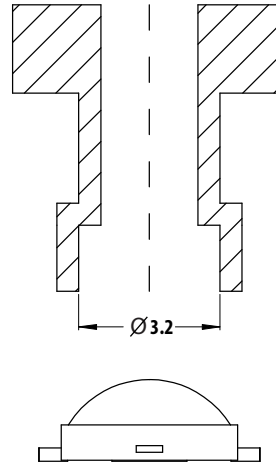

**Figure 28: Recommended Soldering Profile**

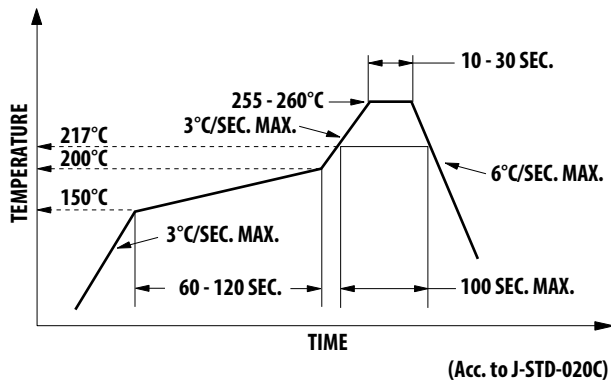

**NOTE:** For detailed information on reflow soldering of Broadcom surface-mount LEDs, refer to Broadcom Application Note AN1060, *Surface Mounting SMT LED Indicator Components*.

# Tape and Reel – Option 1

Figure 29: Carrier Tape Dimensions

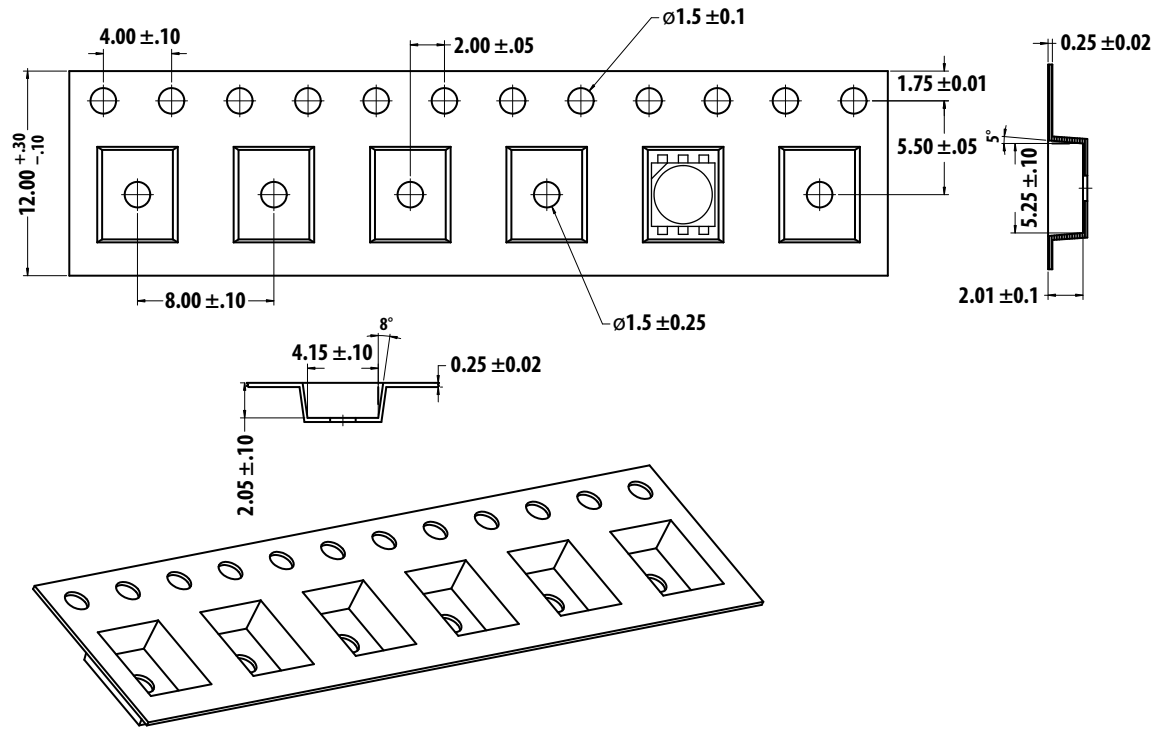

**NOTE:** All dimensions are in millimeters.

Figure 30: Reel Dimensions

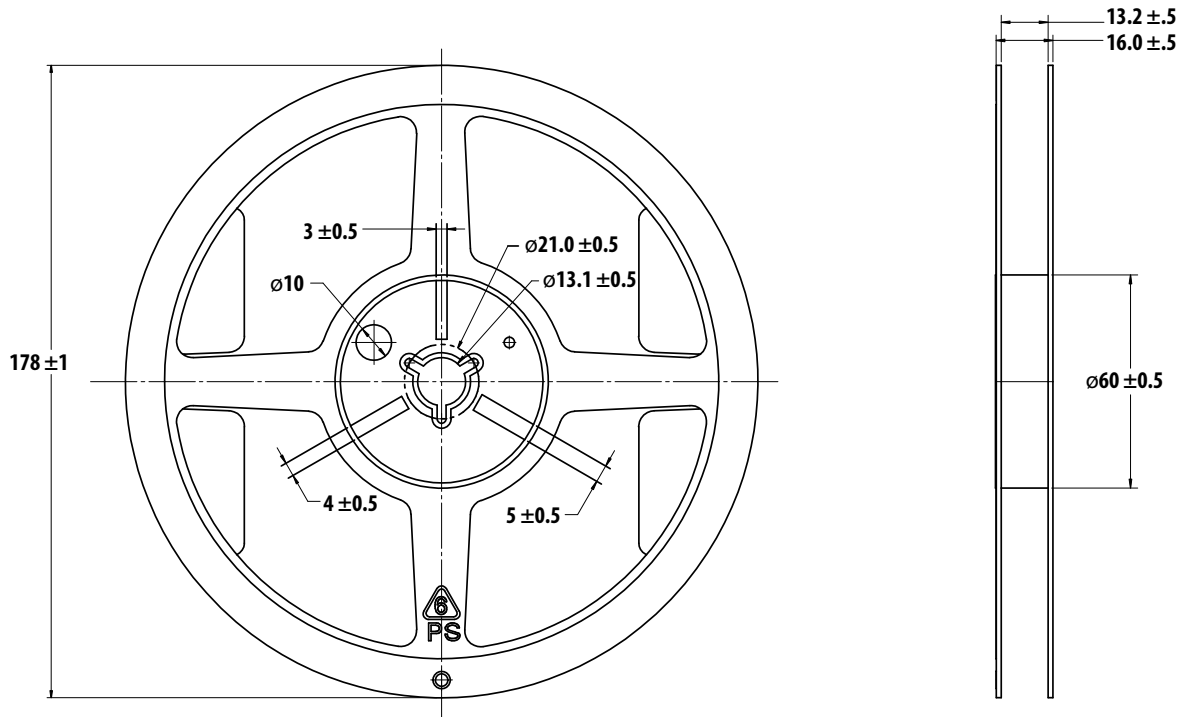

**NOTE:**

1. Empty component pockets sealed with top cover tape.
2. 250 or 500 pieces per reel.
3. Drawing not to scale.
4. All dimensions are in millimeters.

Figure 31: Reeling Orientation

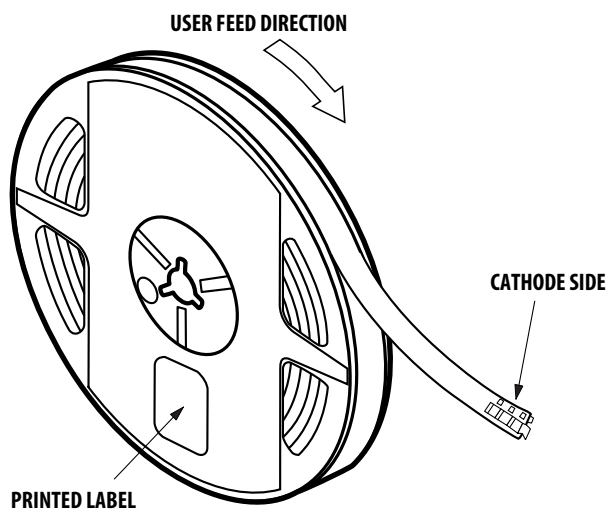



## Disclaimer

Broadcom's products and software are not specifically designed, manufactured, or authorized for sale as parts, components, or assemblies for the planning, construction, maintenance, or direct operation of a nuclear facility or for use in medical devices or applications. The customer is solely responsible, and waives all rights to make claims against Broadcom or its suppliers, for all loss, damage, expense, or liability in connection with such use.

Copyright © 2017–2021 Broadcom. All Rights Reserved. The term “Broadcom” refers to Broadcom Inc. and/or its subsidiaries. For more information, go to [www.broadcom.com](http://www.broadcom.com). All trademarks, trade names, service marks, and logos referenced herein belong to their respective companies.

Broadcom reserves the right to make changes without further notice to any products or data herein to improve reliability, function, or design. Information furnished by Broadcom is believed to be accurate and reliable. However, Broadcom does not assume any liability arising out of the application or use of this information, nor the application or use of any product or circuit described herein, neither does it convey any license under its patent rights nor the rights of others.

