

IP67 Sealed Toggle Switches

Highest quality for the most demanding applications



3300 Series

Standard 15/32" diameter bushing. Standard Bat length is .560".

Current Rating	Catalog No.		Action	Termination
20A -125VAC, 1 HP	3305C	Fig 1	SPST on-none-off	.250" QC
20A -125VAC, 1 HP	3305D	Fig 2	SPST on-none-off	6" Wire Leads, #12 Gauge
20A -125VAC, 1 HP	3301C	Fig 1	SPDT on-none-on	.250" QC
20A -125VAC, 1 HP	3301D	Fig 2	SPDT on-none-on	6" Wire Leads, #12 Gauge
20A -125VAC, 1 HP	3302C	Fig 1	SPDT on-off-on	.250" QC
20A -125VAC, 1 HP	3302D	Fig 2	SPDT on-off-on	6" Wire Leads, #12 Gauge

3300 Series Toggle

Electrical Rating: 20A - 125 VAC , 10A - 250 VAC, 1 HP 125-250 VAC

Life Cycles: 100,000 Electrical 100,000 Mechanical

Operating Temp: -10 °C to +65 °C

Sealing: seal tested per IP67 standards to withstand submersion in water to a depth of 1 meter for 30 minutes, Meets IP68

Dielectric Strength 1000 Volts RMS Minimum

Mounting Means 15/32" Bushing, Keyway .078 - .083 Wide X .037 - .043 Deep, Standard Hardware supplied

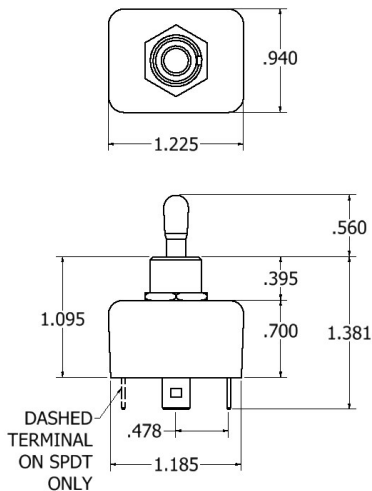

Fig 1

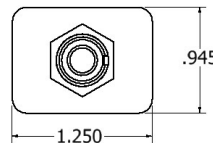
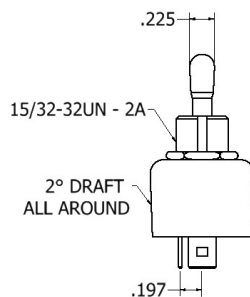
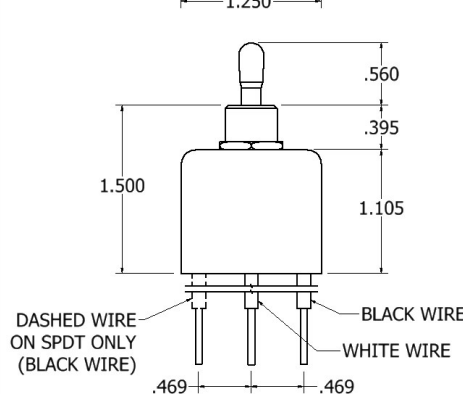

Fig 2



All Information subject to change without notice