

NOTES

- ① 偶数極に適用
APPLY FOR EVEN CKT
- ② 関連製品・書類はSHEET 3を参照ください
REFER TO SHEET 3 ABOUT RELATED PRODUCTS AND DOCUMENTS.
- ③ オーダー番号(製品番号): SHEET 4の製品一覧を参照のこと
ORDER No. (PRODUCT No.) : REFER TO SHEET 4 FOR PRODUCT LIST.

502578 ********

シリーズ番号 極数 色
SERIES NO CIRCUIT SIZE COLOR

CIRCUIT	ハウジングカラー HOUSING COLOR NO.
02~15	00:ナチュラル NATURAL
	01:黒 BLACK
	02:赤 RED
	03:黄 YELLOW
	04:青 BLUE
	05:桃 PINK
	06:緑 GREEN
	07:茶 BROWN
	08:橙 ORANGE
	09:紫 VIOLET
03~05	11:灰 GRAY
	16:黄緑 YELLOWISH GREEN
02~05	14:水 PALE BLUE

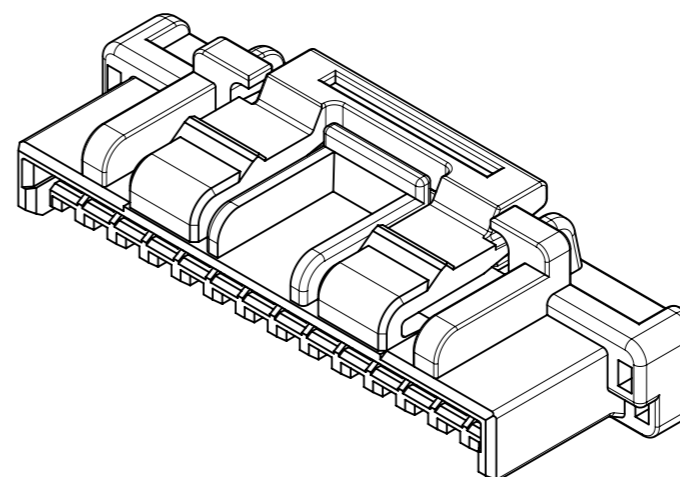

21	26.8	±0.25	15
19.5	25.3		14
18	23.8		13
16.5	22.3		12
15	20.8		11
13.5	19.3		10
12	17.8		9
10.5	16.3		8
9	14.8		7
7.5	13.3		6
6	11.8	±0.20	5
4.5	10.3		4
3	8.8		3
1.5	7.3	2	
B	A		極数 CKT SIZE

④ トレードマーク : Mプラス 2文字の製造工場を示すアルファベットにて表示。
但し、"J"はJAPANを、"L"はMALAYSIAを示す。(例: MXJ, MXL)
金型番号 : アルファベット2文字にて表示。(例: 1A, 12A, 1B, 12B)

部品 PART	材質 MATERIAL
ハウジング HOUSING	ポリエステル(PBT), UL94V-0, 色 : SEE CHART POLYESTER (PBT), UL94V-0, COLOR : SEE CHART

DOCUMENT STATUS	P1	RELEASE DATE	2019/11/20	09:03:13
-----------------	----	--------------	------------	----------

DIMENSION UNITS		SCALE	CURRENT REV DESC:		molex		
mm	NTS				CLIK-MATE 1.5 SINGLE PLUG HSG		
GENERAL TOLERANCES (UNLESS SPECIFIED)			EC NO: 627408		PRODUCT CUSTOMER DRAWING		
ANGULAR TOL	± 3.0 °		DRWN: AISHIKAWA	2018/04/25	DOCUMENT NUMBER		
4 PLACES	± 0.2		CHK'D: SAKIYAMA	2019/11/15	DOC TYPE DOC PART REVISION		
3 PLACES	± 0.2		APPR: KOMURAKAMI	2019/11/20	5025780000-SD PSD 000 A		
2 PLACES	± 0.2		INITIAL REVISION:		MATERIAL NUMBER		
1 PLACE	± 0.2		DRWN: AISHIKAWA	2018/04/25	CUSTOMER		
0 PLACES	± 0.2		APPR: KOMURAKAMI	2019/11/20	SEE CHART		
DRAFT WHERE APPLICABLE MUST REMAIN WITHIN DIMENSIONS		THIRD ANGLE PROJECTION	DRAWING	SERIES	SHEET NUMBER		
		⊕	A3-SIZE	502578	1 OF 4		

極数別ロック形状

LOCK SHAPE AT EACH CKT

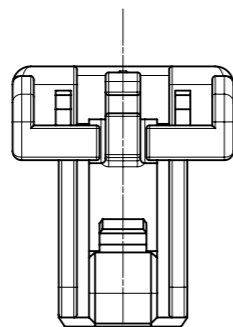
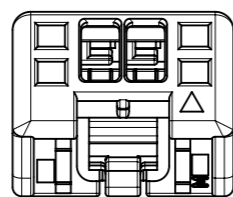

2,3極形状(1ロック)

FIGURE OF 2,3 CIRCUIT (1 LOCK)

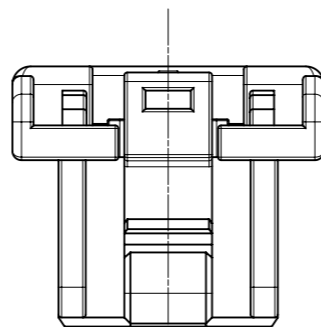
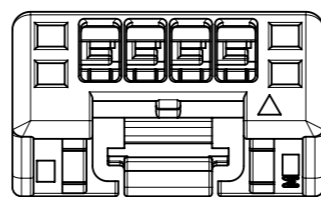

4,5極形状(1ロック)

FIGURE OF 4,5 CIRCUIT (1 LOCK)

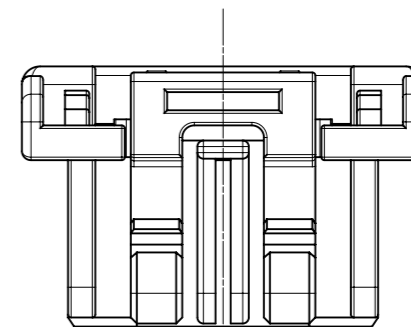
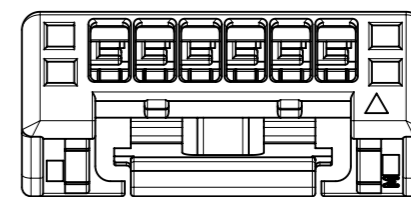

6極形状(2ロック)

FIGURE OF 6 CIRCUIT(2 LOCKS)

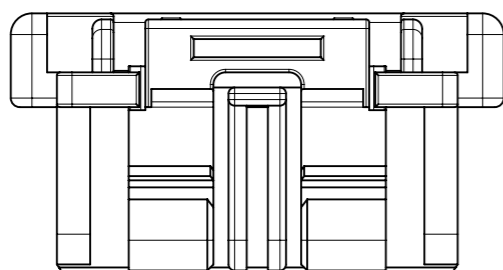
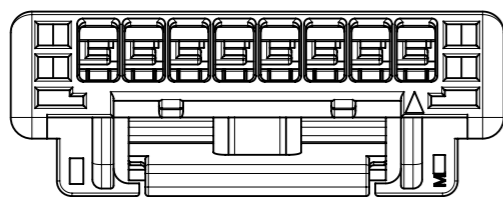

7-11極形状(2ロック)

FIGURE OF 7-11 CIRCUIT (2 LOCKS)

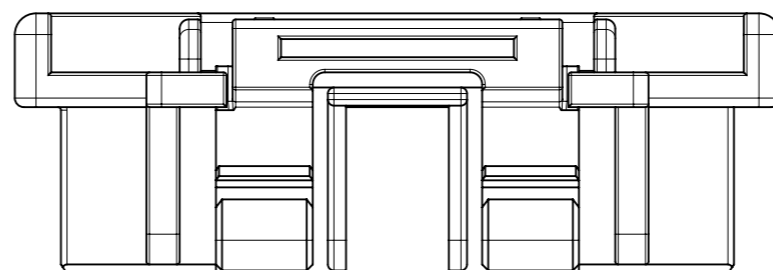
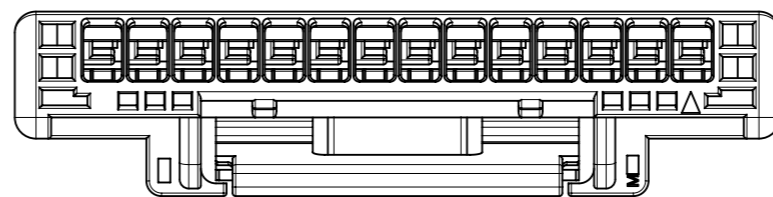

12-15極形状(2ロック)

FIGURE OF 12-15 CIRCUIT (2 LOCKS)

THIS DRAWING CONTAINS INFORMATION THAT IS PROPRIETARY TO MOLEX ELECTRONIC TECHNOLOGIES, LLC AND SHOULD NOT BE USED WITHOUT WRITTEN PERMISSION									
DIMENSION UNITS		SCALE		CURRENT REV DESC:				molex	
mm		NTS							
GENERAL TOLERANCES (UNLESS SPECIFIED)									
ANGULAR TOL		± 3.0 °		EC NO: 627408					
4 PLACES		± 0.2		DRWN: AISHIKAWA		2018/04/25		CLIK-MATE 1.5	
3 PLACES		± 0.2		CHK'D: SAKIYAMA		2019/11/15		SINGLE PLUG HSG	
2 PLACES		± 0.2		APPR: KOMURAKAMI		2019/11/20		PRODUCT CUSTOMER DRAWING	
1 PLACE		± 0.2		INITIAL REVISION:					
0 PLACES		± 0.2		DRWN: AISHIKAWA		2018/04/25		DOCUMENT NUMBER	
				APPR: KOMURAKAMI		2019/11/20		5025780000-SD	
DRAFT WHERE APPLICABLE MUST REMAIN WITHIN DIMENSIONS		THIRD ANGLE PROJECTION		DRAWING		SERIES		MATERIAL NUMBER	
				A3-SIZE		502578		SEE CHART	
								CUSTOMER	
								SHEET NUMBER	
								2 OF 4	

△ 適用製品及び各種仕様書
 APPLICABLE PRODUCTS AND VARIOUS SPECIFICATIONS

梱包仕様書 PACKAGING SPECIFICATION	PART NUMBER	DOCUMENT NUMBER
	502578 ****	SPK-502578-001

適用端子 APPLICABLE TERMINAL	PLATING TYPE	PART NUMBER	WIRE SIZE(AWG)
	TIN	502579 0000	#24 - #28
		503429 0000	#26 - #30
	GOLD	213028 **00	#24 - #26
213029 **00		#26 - #28	

適合レセプタクルコネクタ APPLICABLE REC. CONNECTOR	SMT				THROUGH HOLE	
	TIN PLATING		GOLD PLATING		TIN PLATING	
	VERTICAL	RIGHT ANGLE	VERTICAL	RIGHT ANGLE	VERTICAL	RIGHT ANGLE
シリーズ番号 SERIES No.	502584	502585	213225	213226	503159	503175
製品仕様書 PRODUCT SPECIFICATION	5025780000-PS		5025780004-PS		5025780002-PS	
アプリケーション仕様書 APPLICATION SPECIFICATION	AS-502578-001(JAPANESE)/-002(ENGLISH)					

適合レセプタクルコネクタ APPLICABLE REC. CONNECTOR	BOTTOM ENTRY
	TIN PLATING
	VERTICAL
シリーズ番号 SERIES No.	503395
製品仕様書 PRODUCT SPECIFICATION	5025780003-PS
アプリケーション仕様書 APPLICATION SPECIFICATION	AS-503395-001

THIS DRAWING CONTAINS INFORMATION THAT IS PROPRIETARY TO MOLEX ELECTRONIC TECHNOLOGIES, LLC AND SHOULD NOT BE USED WITHOUT WRITTEN PERMISSION									
DIMENSION UNITS	SCALE	CURRENT REV DESC:				molex			
mm	NTS								
GENERAL TOLERANCES (UNLESS SPECIFIED)		EC NO: 627408				CLIK-MATE 1.5 SINGLE PLUG HSG			
ANGULAR TOL ± 3.0 °		DRWN: AISHIKAWA 2018/04/25							
4 PLACES ± 0.2		CHK'D: SAKIYAMA 2019/11/15				PRODUCT CUSTOMER DRAWING			
3 PLACES ± 0.2		APPR: KOMURAKAMI 2019/11/20							
2 PLACES ± 0.2		INITIAL REVISION:				DOCUMENT NUMBER 5025780000-SD			
1 PLACE ± 0.2		DRWN: AISHIKAWA 2018/04/25							
0 PLACES ± 0.2		APPR: KOMURAKAMI 2019/11/20				DOC TYPE DOC PART REVISION PSD 000 A			
DRAFT WHERE APPLICABLE MUST REMAIN WITHIN DIMENSIONS		THIRD ANGLE PROJECTION	DRAWING	SERIES	MATERIAL NUMBER				
			A3-SIZE	502578	SEE CHART		3 OF 4		

3 製品一覧 PRODUCTS LIST

HOUSING COLOR										
紫 VIOLET	橙 ORANGE	茶 BROWN	緑 GREEN	桃 PINK	青 BLUE	黄 YELLOW	赤 RED	黒 BLACK	ナチュラル NATURAL	
502578 1509	502578 1508	502578 1507	502578 1506	502578 1505	502578 1504	502578 1503	502578 1502	502578 1501	502578 1500	15
502578 1409	502578 1408	502578 1407	502578 1406	502578 1405	502578 1404	502578 1403	502578 1402	502578 1401	502578 1400	14
502578 1309	502578 1308	502578 1307	502578 1306	502578 1305	502578 1304	502578 1303	502578 1302	502578 1301	502578 1300	13
502578 1209	502578 1208	502578 1207	502578 1206	502578 1205	502578 1204	502578 1203	502578 1202	502578 1201	502578 1200	12
502578 1109	502578 1108	502578 1107	502578 1106	502578 1105	502578 1104	502578 1103	502578 1102	502578 1101	502578 1100	11
502578 1009	502578 1008	502578 1007	502578 1006	502578 1005	502578 1004	502578 1003	502578 1002	502578 1001	502578 1000	10
502578 0909	502578 0908	502578 0907	502578 0906	502578 0905	502578 0904	502578 0903	502578 0902	502578 0901	502578 0900	9
502578 0809	502578 0808	502578 0807	502578 0806	502578 0805	502578 0804	502578 0803	502578 0802	502578 0801	502578 0800	8
502578 0709	502578 0708	502578 0707	502578 0706	502578 0705	502578 0704	502578 0703	502578 0702	502578 0701	502578 0700	7
502578 0609	502578 0608	502578 0607	502578 0606	502578 0605	502578 0604	502578 0603	502578 0602	502578 0601	502578 0600	6
502578 0509	502578 0508	502578 0507	502578 0506	502578 0505	502578 0504	502578 0503	502578 0502	502578 0501	502578 0500	5
502578 0409	502578 0408	502578 0407	502578 0406	502578 0405	502578 0404	502578 0403	502578 0402	502578 0401	502578 0400	4
502578 0309	502578 0308	502578 0307	502578 0306	502578 0305	502578 0304	502578 0303	502578 0302	502578 0301	502578 0300	3
502578 0209	502578 0208	502578 0207	502578 0206	502578 0205	502578 0204	502578 0203	502578 0202	502578 0201	502578 0200	2
オーダー番号 ORDER No										極数 CIRCUIT No

HOUSING COLOR			
黄緑 YELLOWISH GREEN	水色 PALE BLUE	灰 GRAY	
-	-	-	15
-	-	-	14
-	-	-	13
-	-	-	12
-	-	-	11
-	-	-	10
-	-	-	9
-	-	-	8
-	-	-	7
-	-	-	6
502578 0516	502578 0514	502578 0511	5
502578 0416	502578 0414	502578 0411	4
502578 0316	502578 0314	502578 0311	3
-	502578 0214	-	2
オーダー番号 ORDER No.			極数 CIRCUIT No.

THIS DRAWING CONTAINS INFORMATION THAT IS PROPRIETARY TO MOLEX ELECTRONIC TECHNOLOGIES, LLC AND SHOULD NOT BE USED WITHOUT WRITTEN PERMISSION									
DIMENSION UNITS mm	SCALE NTS	CURRENT REV DESC:			molex				
GENERAL TOLERANCES (UNLESS SPECIFIED)		EC NO: 627408							
ANGULAR TOL ± 3.0°	4 PLACES ± 0.2	DRWN: AISHIKAWA 2018/04/25			CLIK-MATE 1.5 SINGLE PLUG HSG				
3 PLACES ± 0.2	2 PLACES ± 0.2	CHK'D: SAKIYAMA 2019/11/15			PRODUCT CUSTOMER DRAWING				
1 PLACE ± 0.2	0 PLACES ± 0.2	APPR: KOMURAKAMI 2019/11/20			DOCUMENT NUMBER				
DRAFT WHERE APPLICABLE MUST REMAIN WITHIN DIMENSIONS		INITIAL REVISION:			5025780000-SD				
THIRD ANGLE PROJECTION		DRWN: AISHIKAWA 2018/04/25			DOC TYPE		DOC PART		REVISION
DRAWING		APPR: KOMURAKAMI 2019/11/20			PSD		000		A
SERIES		A3-SIZE 502578			MATERIAL NUMBER		CUSTOMER		SHEET NUMBER
4 OF 4									