

LCA Series Subminiature Snap-acting Switches



Features/Benefits

- Compact design
- Long life and high electrical capacity
- Quick connect, solder terminals, PC terminals
- Wide variety of actuator styles
- RoHS compatible

Typical Applications

- Motorized equipment
- Sump pump
- Thermostatic controls



Specifications

CONTACT RATING: From low level to 10 AMPS @ 125 V AC
 ELECTRICAL LIFE: 6,000 cycles at 10 AMPS @ 125 V AC
 10,000 cycles at 8 AMPS @ 125 V AC
 50,000 cycles at 3 AMPS @ 125 V AC
 INSULATION RESISTANCE: 100 M ohm min.
 DIELECTRIC STRENGTH: 1,500 Vrms min. @ sea level.
 OPERATING TEMPERATURE: -10°C to +125°C
 OPERATING FORCE: 140 grams at actuator button MAX.
 Forces are less at free end of lever actuators; (see ACTUATOR'S option sections).
 MOUNTING: 2-56 screws, torque 2.3 in/lbs max.

Materials

SWITCH HOUSING: Thermoplastic polyester or high temperature thermoplastic (PTS) (UL 94V-0).
 ACTUATOR BUTTON: Thermoplastic polyester.
 SPRING: Copper alloy.
 PIVOT: Copper alloy.
 MOVABLE CONTACTS: Silver Nickel for 10A option
 Gold plate for 00A option
 STATIONARY CONTACTS: Silver nickel on copper alloy.
 TERMINALS: Copper alloy.
 ACTUATOR LEVER: Stainless steel.

NOTE: Specifications and materials listed above are for switches with standard options.
 For information on specific and custom switches, consult Customer Service center.

Build-A-Switch

To order, simply select desired option from each category and place in the appropriate box. Available options are shown and described on pages K-22 thru K-24. For additional options not shown in catalog, consult Customer Service Center.

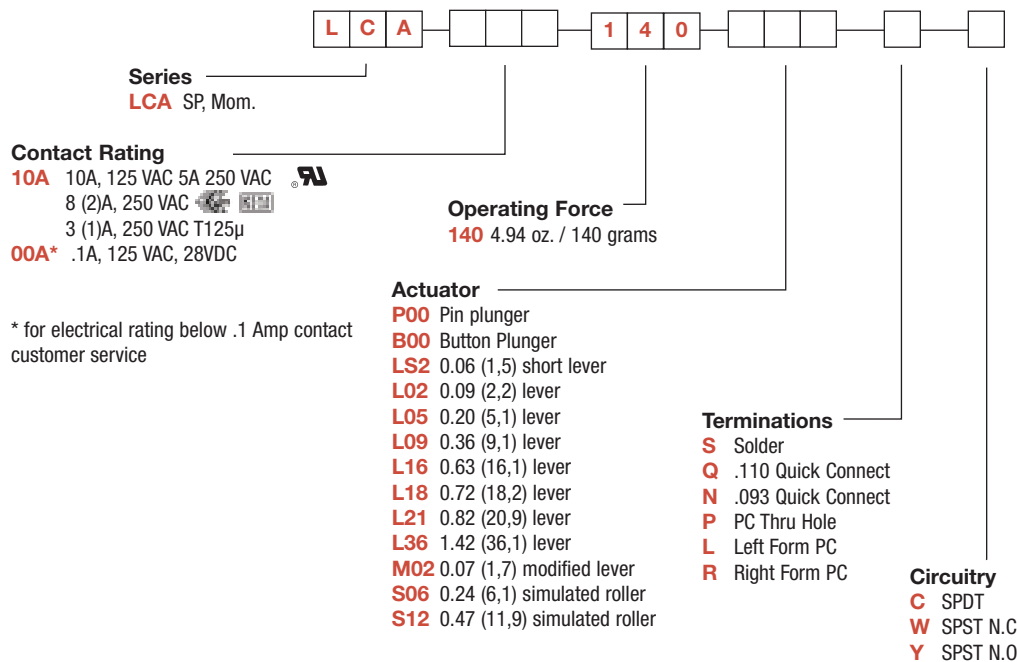

Dimensions are shown: Inch (mm)
 Specifications and dimensions subject to change



LCA Series Subminiature Snap-acting Switches

SERIES

LCA

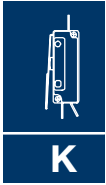
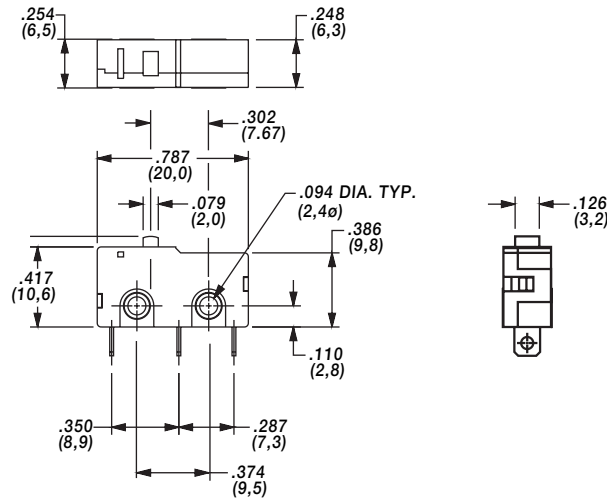

Snap-acting

ELECTRICAL RATING

RoHS COMPLIANT *	RoHS COMPATIBLE *	OPTION CODE	ELECTRICAL RATING	
YES	YES	10A	10A, 125 VAC 5A 250 VAC 8 (2)A, 250 VAC 3 (1)A, 250 VAC T125μ	
YES	YES	00A**	.1A, 125, VAC, 28 V DC	

* Note: See Technical Data section of this catalog for RoHS compliant and compatible definition and specifications.
** For electrical rating below .1 Amp, contact customer service.

OPERATING FORCE

OPTION CODE	OPERATING FORCES (oz/grams)
140	4.94 / 140 grams max.



Dimensions are shown: Inch (mm)
Specifications and dimensions subject to change

LCA Series Subminiature Snap-acting Switches

ACTUATOR 

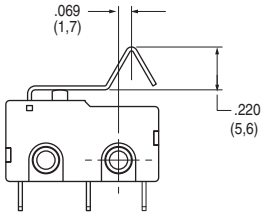
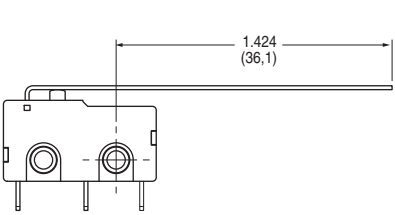
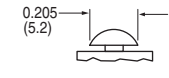
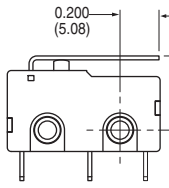
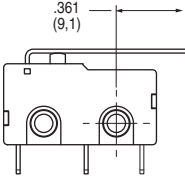
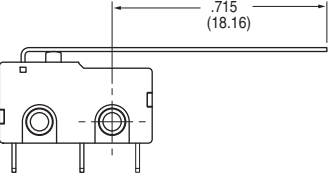
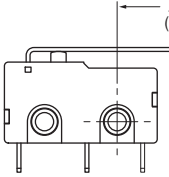
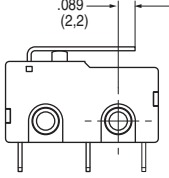
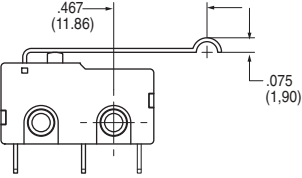
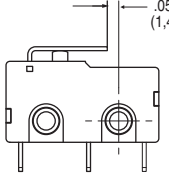
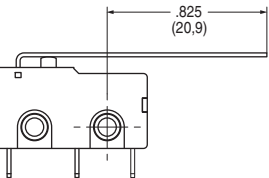
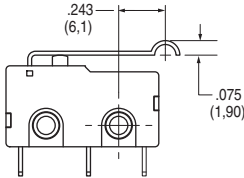
P00	SEE PAGE K-22 FOR DIMENSIONS				
B00		M02*		L36*	
L05*		L09*		L18*	
L16*		L02*		S12*	
LS2*		L21*		* Lever and simulated roller width is 0.158" +/- .003" (Does not apply to P00 and B00 actuator codes)	
S06*					



K

Snap-acting

ACTUATOR CODE	Max Operate Force	
	Grams	oz
P00	140	4.94
B00	140	4.94
LS2	56	1.98
L02	41	1.45
L05	34	1.20
L09	28	0.99
L16	21	0.74
L18	20	0.71
L21	18	0.63
L36	13	0.46
M02	42	1.48
S06	32	1.13
S12	24	0.85



Third Angle
Projection

Dimensions are shown: Inch (mm)
Specifications and dimensions subject to change

LCA Series Subminiature Snap-acting Switches

TERMINATIONS

S SOLDER

Q QUICK CONNECT

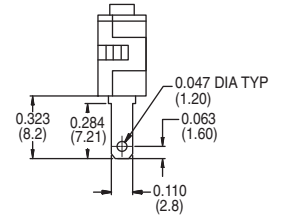
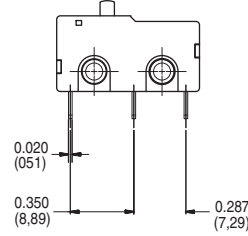
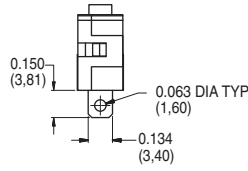
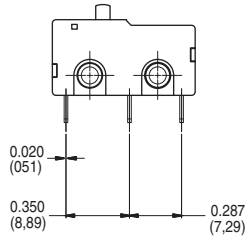

'Q' TERMINAL OPTION

N .093 QUICK CONNECT

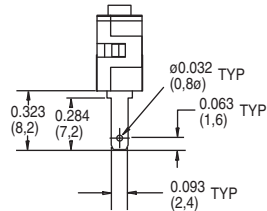
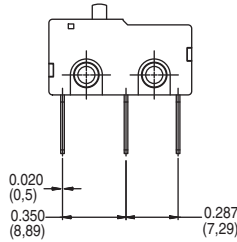

P PC THRU HOLE

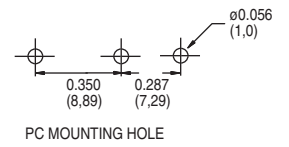
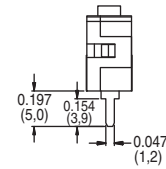
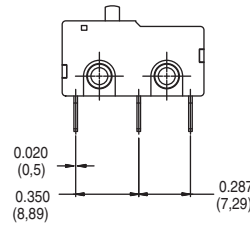

PC MOUNTING HOLE

L LEFT FORM PC

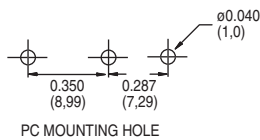
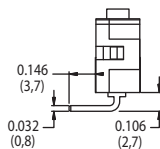
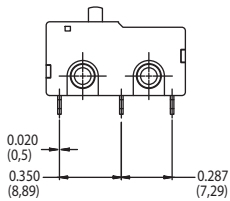

PC MOUNTING HOLE

R RIGHT FORM PC

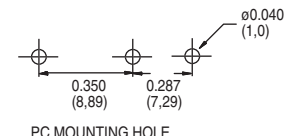
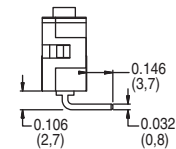
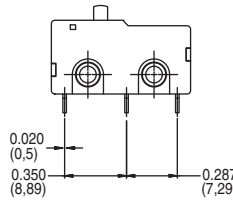

PC MOUNTING HOLE

P00

A	Free position (max):	0.382 in	9,7 mm
B	Operating position:	0.343 in +/- 0.020 in	8,7 mm +/- 0,5 mm
C	Pre-travel (max):	0.031 in	0,8 mm
D	Over-travel (max):	0.020 in	0,5 mm

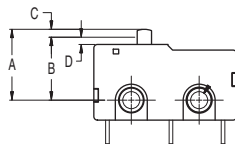

B00

A	Free position (max):	0.433 in	11,0 mm
B	Operating position:	0.394 in +/- 0.020 in	10,0 mm +/- 0,5 mm
C	Pre-travel (max):	0.031 in	0,8 mm
D	Over-travel (max):	0.004 in	0,1 mm



Third Angle
Projection

Dimensions are shown: Inch (mm)
Specifications and dimensions subject to change

G&K

Snap-acting
K

LCA Series Subminiature Snap-acting Switches

CIRCUITRY

- C** SPDT (Single Pole, Double Throw)
- W** SPST N.C. (Single Pole, Single Throw, Normally Closed)
- Y** SPST N.O. (Single Pole, Single Throw, Normally Open)



Snap-acting

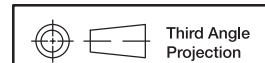

*Dimensions are shown: Inch (mm)
Specifications and dimensions subject to change*