



Datasheet

Part No:
CGGP.35.3.A.02

Description:
3.5mm height GPS/GLONASS/Galileo
Patch Antenna 1575/1610MHz

Features:
Wide-band Operation
35mm*35mm*3.5mm
4dBi Peak Gain (on 50mm*50mm ground-plane)
85% Efficiency (on 50mm*50mm ground-plane)
Pin type
Automotive TS16949 Production and Quality Approved
RoHS & Reach Compliant

1.	Introduction	3
2.	Specifications	4
3.	Antenna Test Setup	5
3.	Antenna Characteristics	6
4.	Antenna Radiation Pattern	8
5.	Axial Ratio	10
6.	Mechanical Drawing	11
7.	PCB Footprint Recommendation	13
8.	Evaluation Board	14
9.	Packaging	15
	Changelog	16

Taoglas makes no warranties based on the accuracy or completeness of the contents of this document and reserves the right to make changes to specifications and product descriptions at any time without notice. Taoglas reserves all rights to this document and the information contained herein. Reproduction, use or disclosure to third parties without express permission is strictly prohibited.



1. Introduction



The Taoglas 35mm ceramic GPS/GLONASS/GALILEO patch antenna, by means of a double resonance design, has unique wide-band operation over the whole operating bands of GPS/GLONASS/Galileo systems spanning from 1575MHz to 1610MHz. It is mounted via pin and double-sided adhesive. This antenna has been tuned for a center position on a 50mm*50mm ground-plane. It is manufactured and tested in a TS16949 first tier automotive approved facility.

For further optimization to customer specific device environments where positioning is off center or on different ground-plane sizes, custom tuned patch antennas can be supplied. Taoglas can also provide different pin lengths for these antennas, subject to potential NRE and MOQ. For more details please contact your regional Taoglas customer support team.

2. Specifications

Electrical		
Application Bands	GPS/Galileo	GLONASS
Operation Frequency	1575.42 ±1.023MHz	1602±5MHz
Bandwidth	22MHz min	
VSWR	1.5	
Peak Gain	4.0dBi typ.	
Gain at Zenith	4.0dBi	
Gain at 10°elevation	1.5dBi typ.	
Axial Ratio	3dB max	
Impedance	50 Ohms	
Efficiency	85% typ.	
Frequency Temperature Coefficient (τf)	0 ± 20ppm / oC	
Mechanical		
Ceramic Dimension	35*35*3.5mm	
Pin Length	2.4mm	
Pin Diameter	0.9mm	
Environmental		
Storage Temperature	-40°C to +85°C	
Operating Temperature	-40°C to +85°C	
Moisture Sensitivity	Level 3	

* Antenna properties were measured with the antenna mounted on 50*50mm Ground Plane

3. Antenna Test Setup

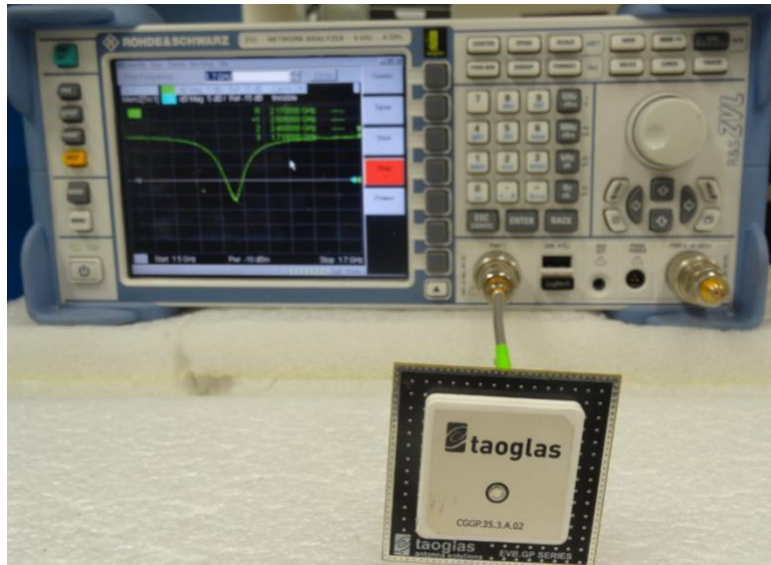

Return Loss measurement of the CGGP.35.3.A.02

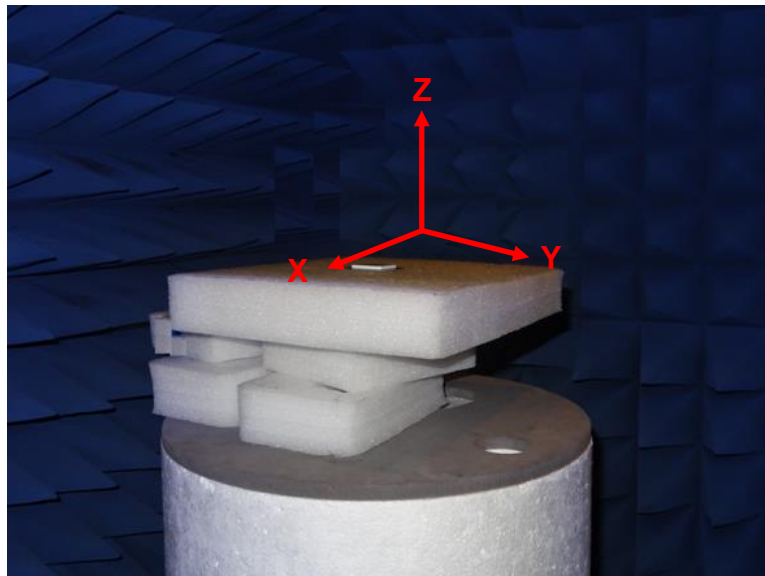

Peak gain, efficiency and radiation pattern measurements of the CGGP.35.3.A.02

4. Antenna Characteristics

4.1 Return Loss

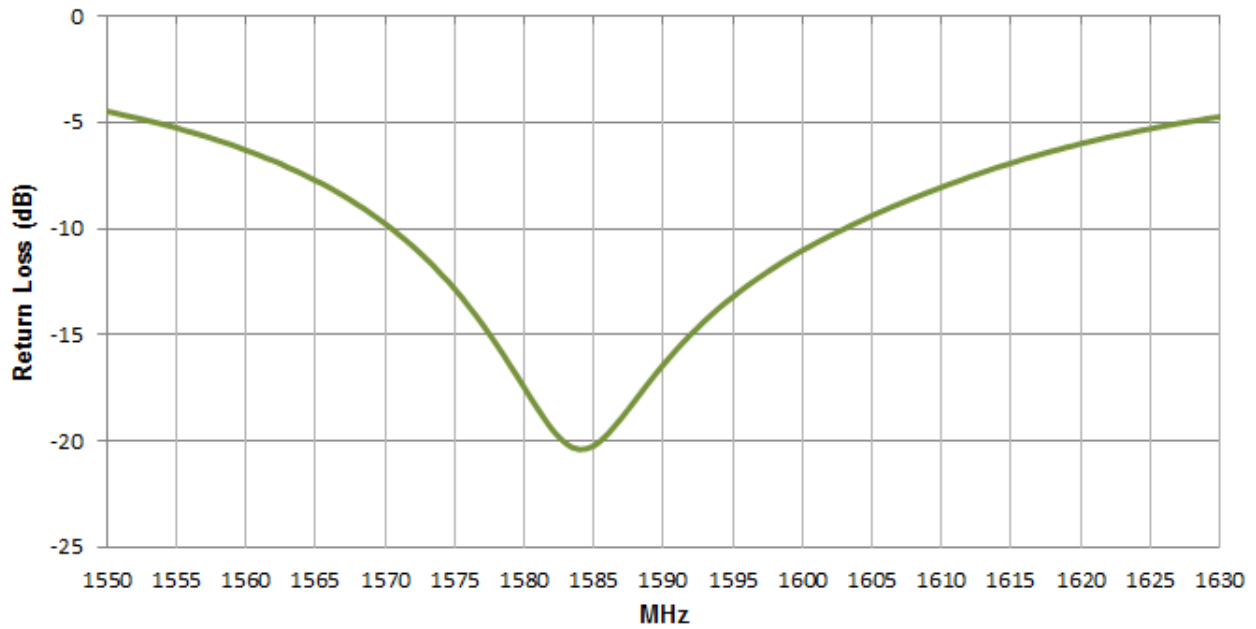

4.2 VSWR

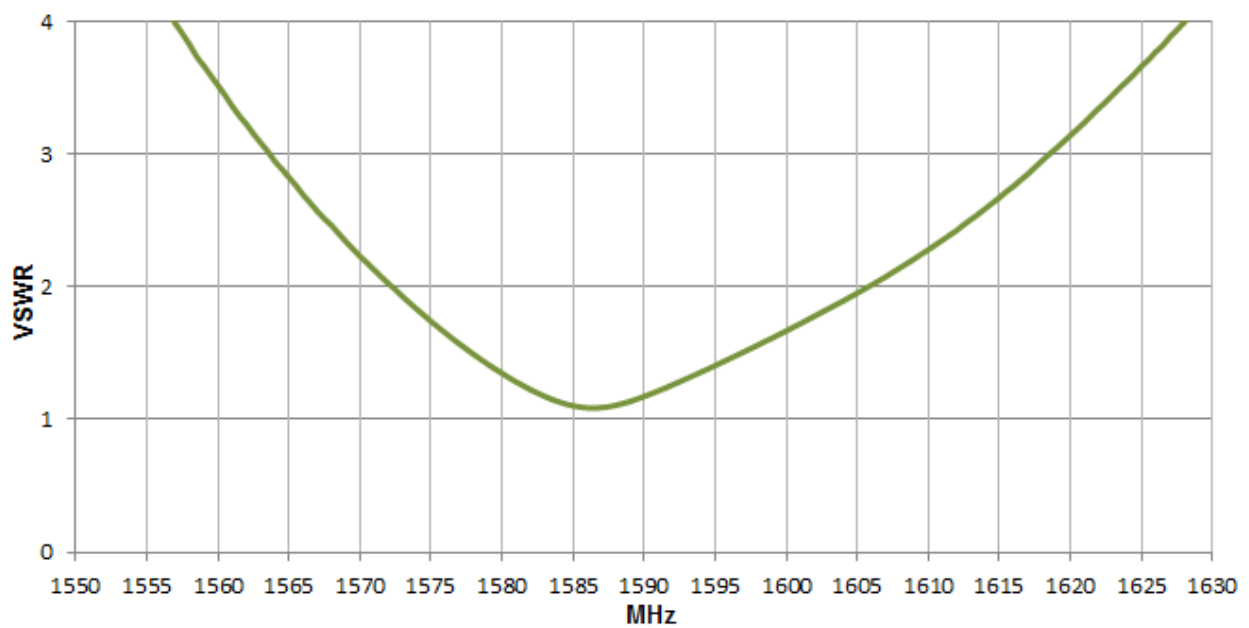

4.3 Efficiency

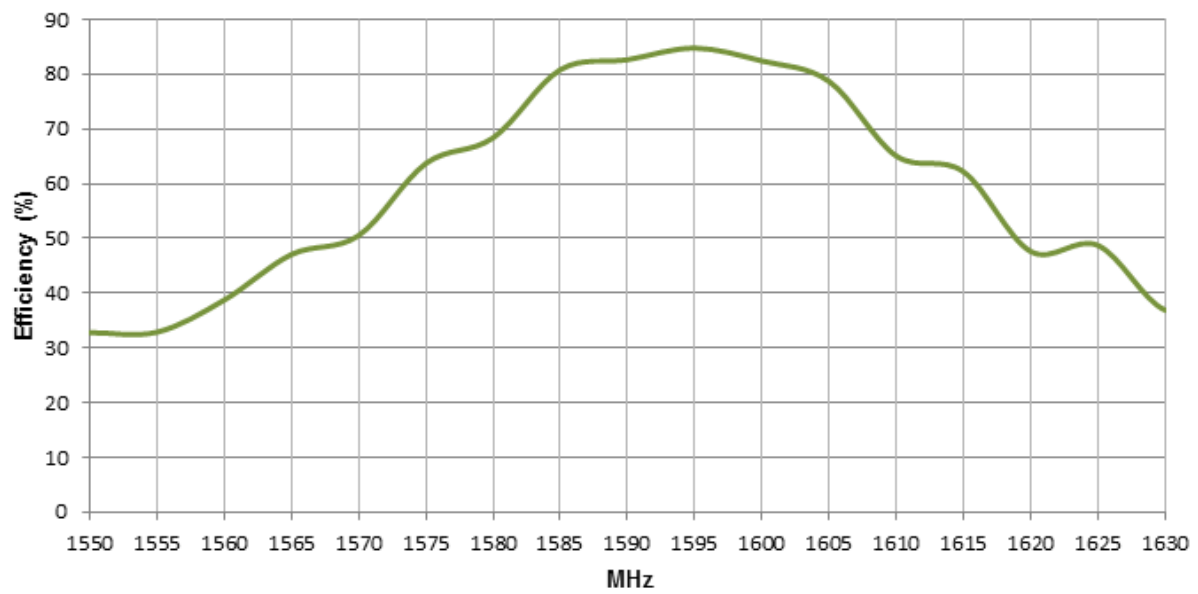

4.4 Peak Gain

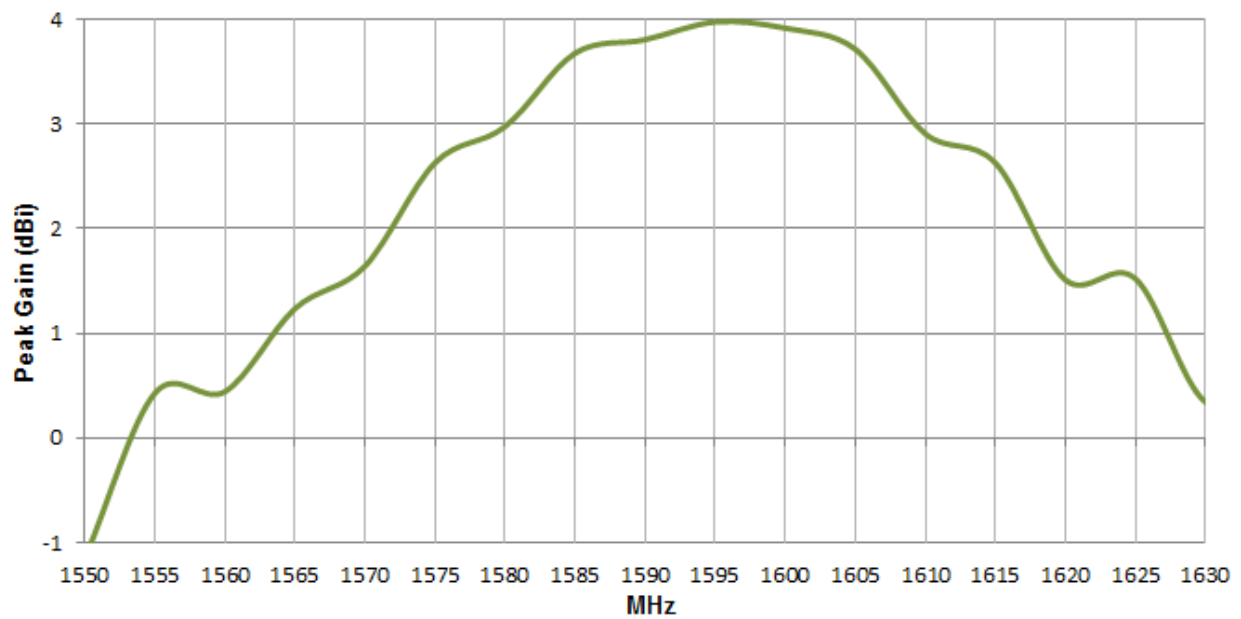

4. Antenna Radiation Pattern

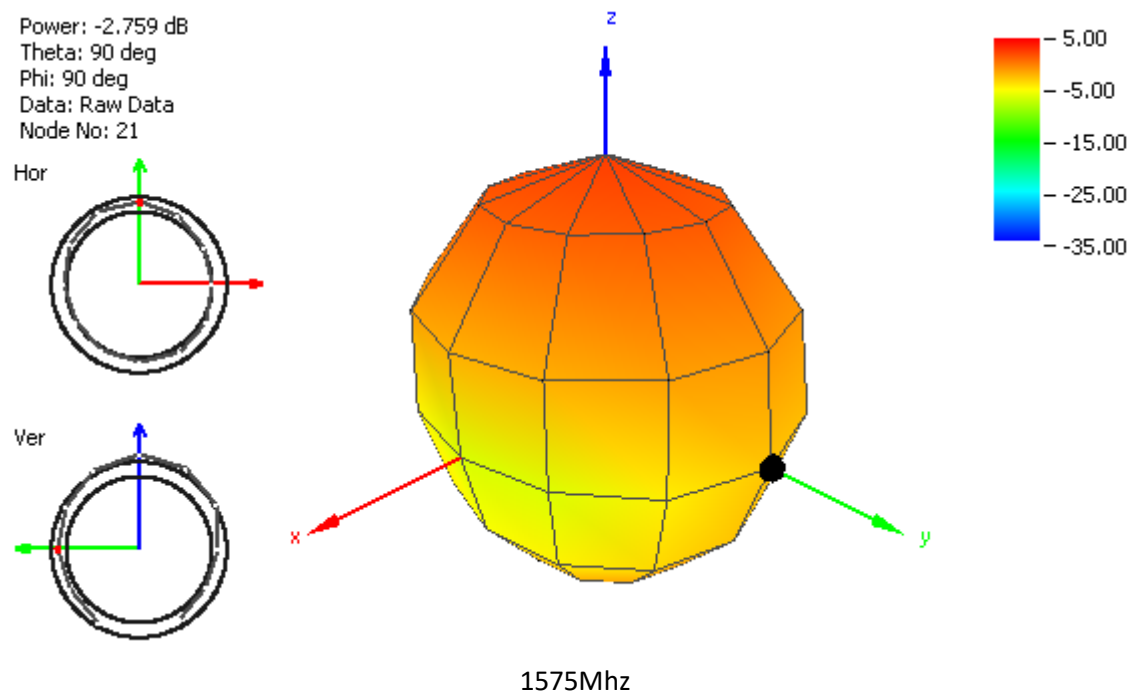
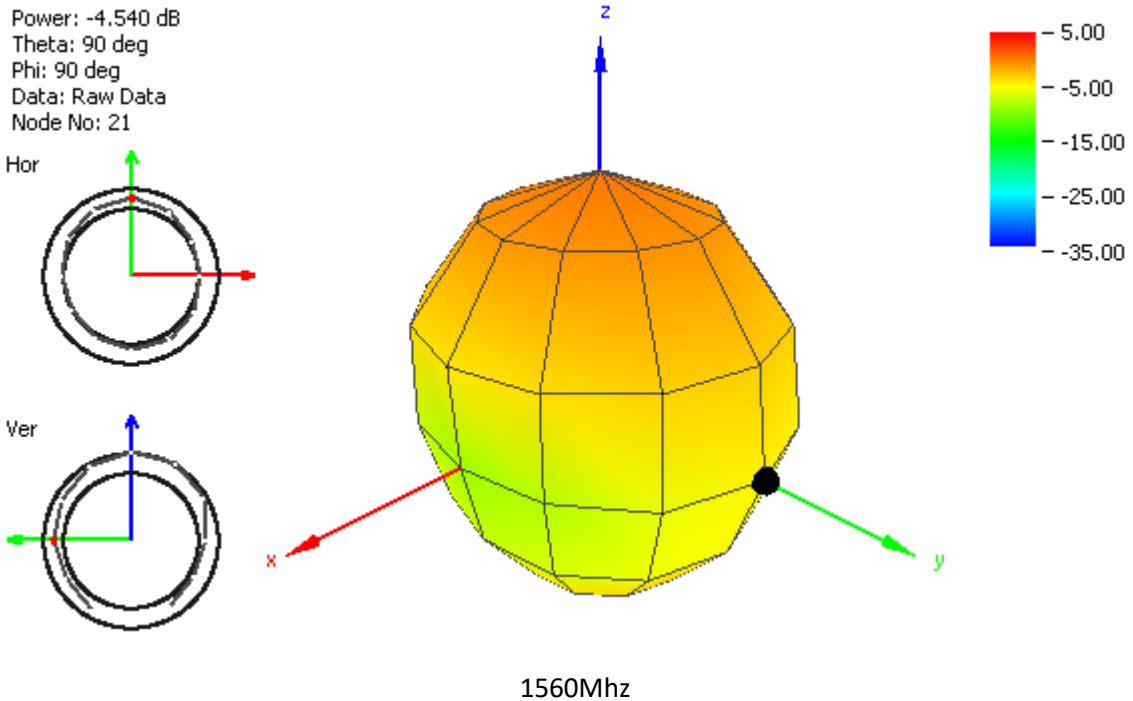

Power: -2.874 dB
 Theta: 90 deg
 Phi: 90 deg
 Data: Raw Data
 Node No: 21

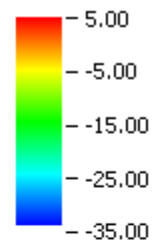
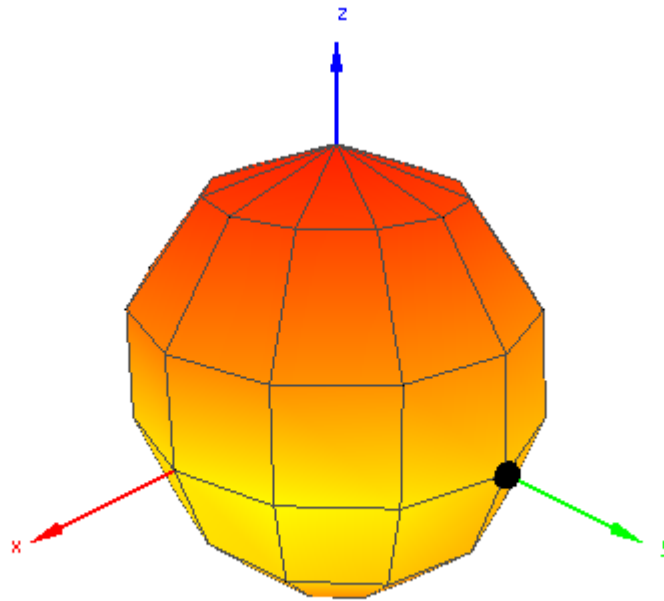
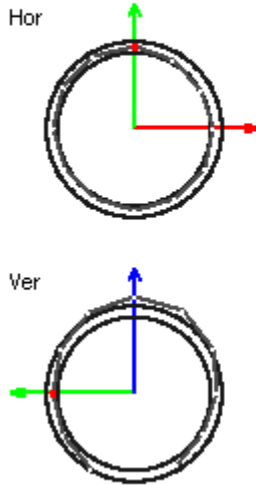

1590Mhz

Power: -4.260 dB
 Theta: 90 deg
 Phi: 90 deg
 Data: Raw Data
 Node No: 21

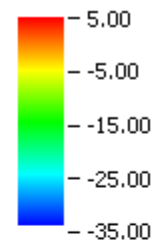
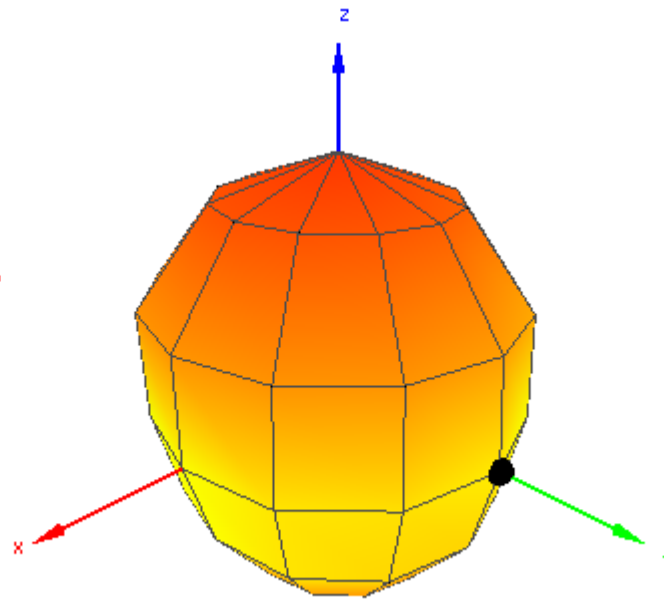
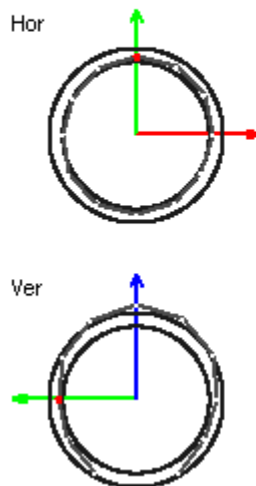

1610Mhz

5. Axial Ratio

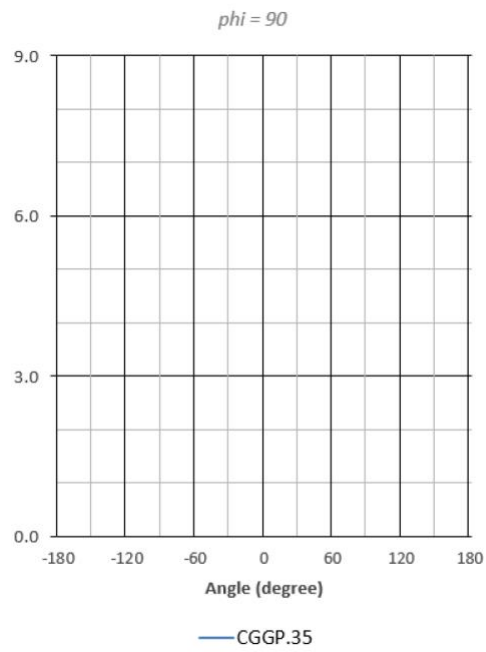
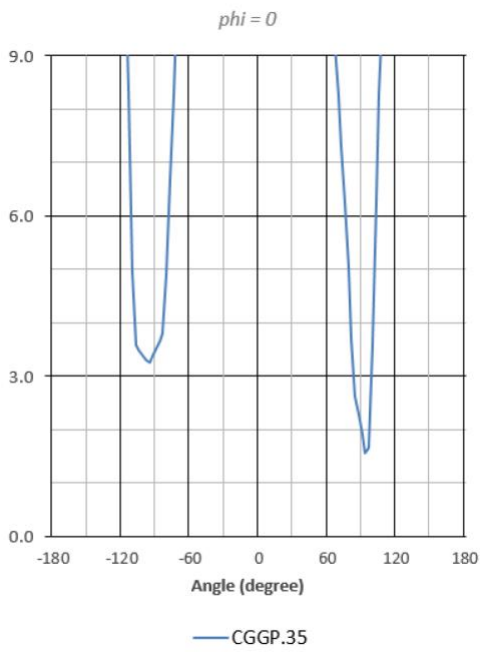

1575.42MHz

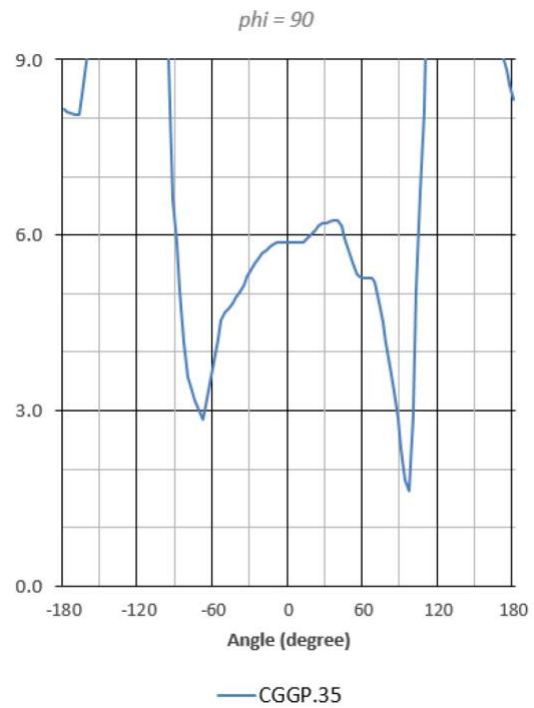
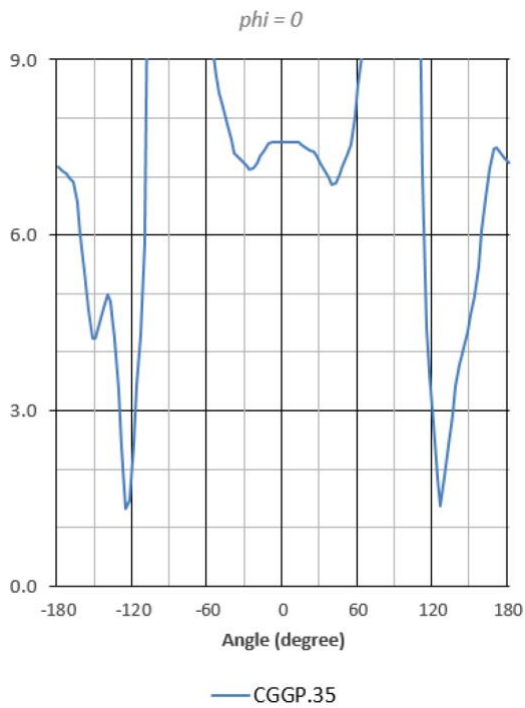

1602MHz

6. Mechanical Drawing (Unit: mm)

ISO NO.: EDW-11-8-387

STATE: Release

NOTES: 1. Double sided adhesive area

REV.	DESCRIPTION	ENG.	APPROVED	DATE
△ A	Initial Design	Kiwi		2011/08/03
△ B	Amend Location of Print	Kiwi		2011/09/01
△ C	Amend Length of Pin, Add P/N.	Kim	Joanna	2015/07/17
△ D	New LOGO (GP-18-8-25) and correct dimension.	Joey	Clack	2019/11/27
△ E	EC-21-08-010	Mickey	Buluto	2021/03/02

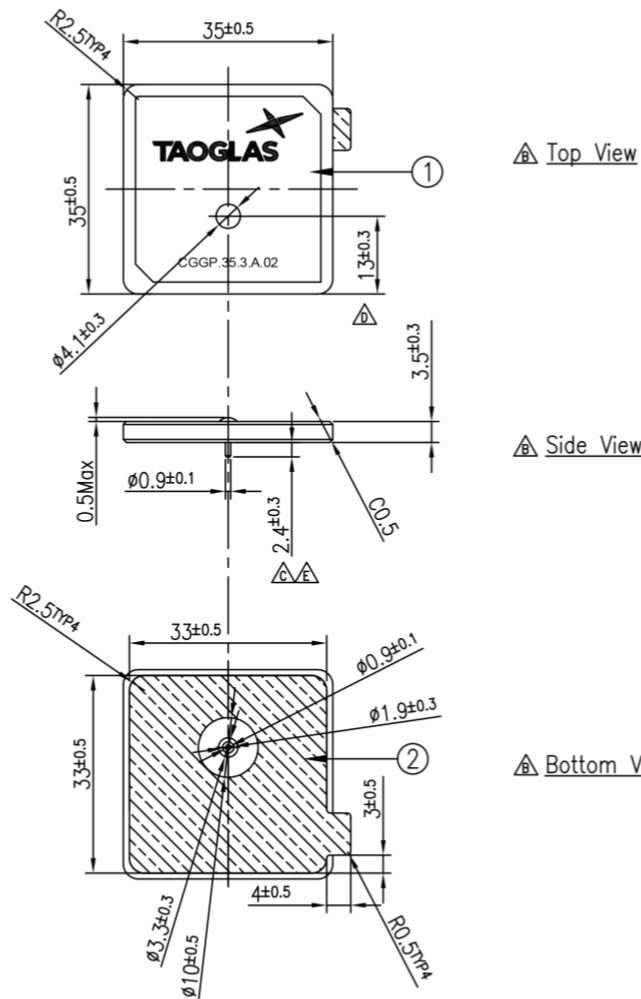

△ Top View

△ Side View

△ Bottom View

APPROVED BY:	TW Design Centre This drawing and its inherent design concepts are property of Taoglas. Not to be copied or given to third parties without the written consent of Taoglas.
CHECK BY:	
DRAWN BY: Kiwi	
DATE: 2011/08/03	
UNLESS OTHERWISE SPECIFIED TOLERANCES ON:	TITLE : 35mm GPS/GLONASS Ceramic Patch
THIRD ANGLE PROJECTION	PART NO. : CGGP.35.3.A.02
	UNIT: mm SCALE: 1:1 PAGES: 1/1 REV: E

	Name	P/N	Material	Finish	QTY
1	CGGP-35 Patch 35x35x0.5	001513CG00007A	Ceramic	Clear	1
2	Double sided Adhesive	001013CG20007A	NI70 5015	White Liner	1

Adhesive Thickness

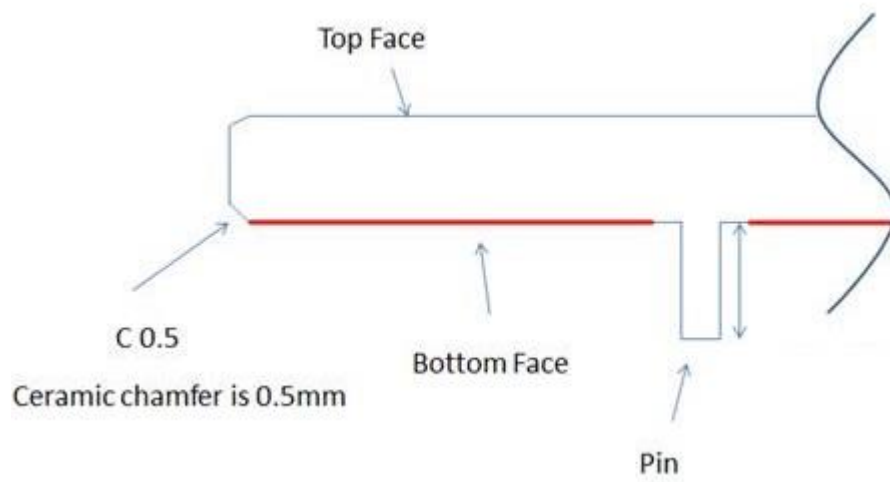

Red Line shows the adhesive without Liner – thickness 0.08~0.1mm

7. PCB Footprint Recommendation

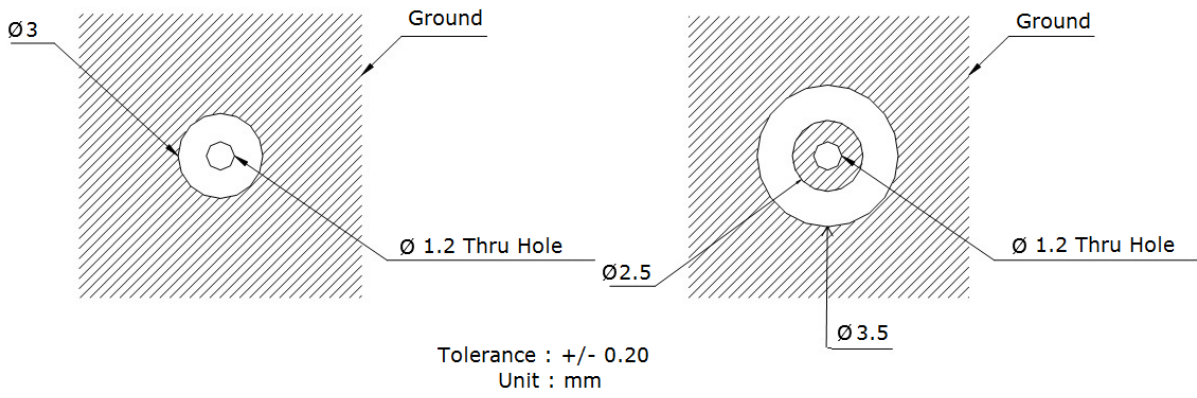

8. Evaluation Board CGGPD.35.A (Unit: mm)

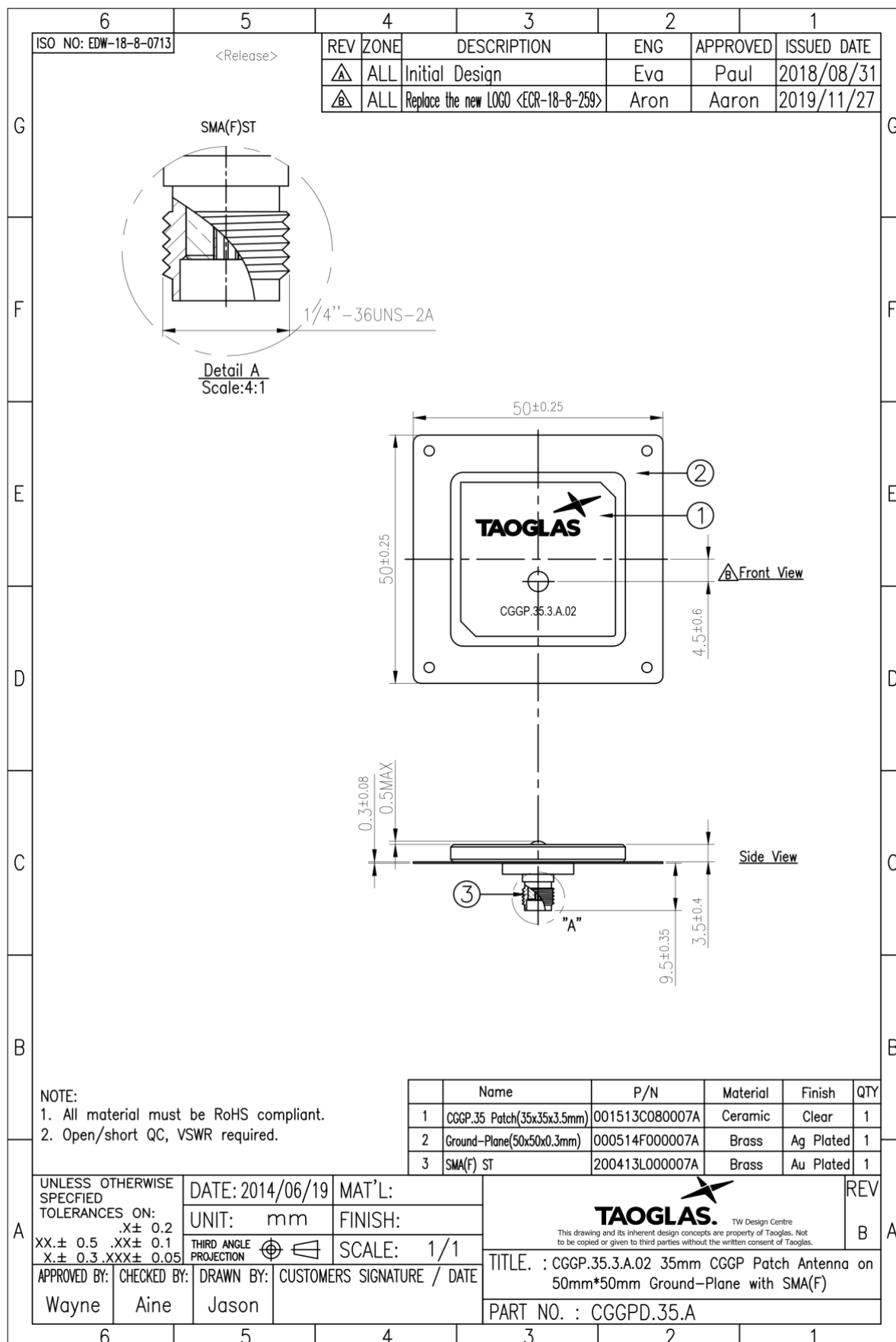

9. Packaging

CGGP.35.3.A.02

Packaging Specifications

12 Pieces CGGP.35 per tray
 Dimensions - Diameter 250*150*20mm
 Weight - 220g

6 Trays per Small Carton
 72 Pieces CGGP.35 Carton
 Dimensions - 260*160*120
 Weight - 1.37Kg

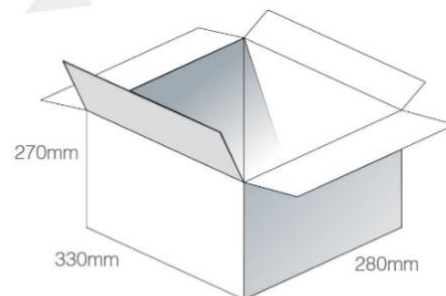
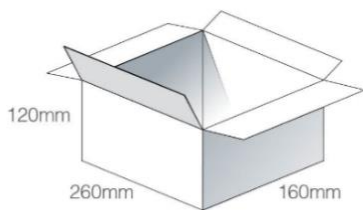
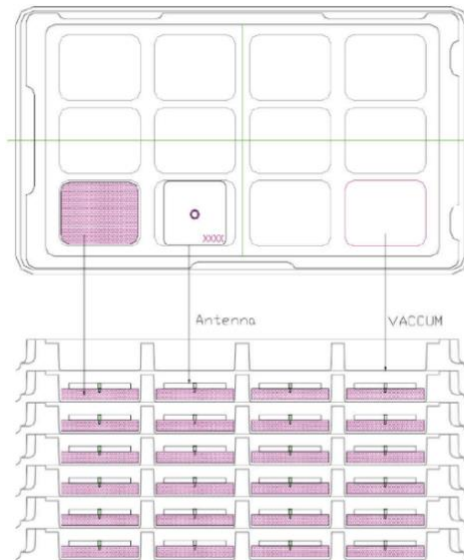

4 Small Cartons per 1 Large Carton
 288 Pieces CGGP.35 per Large Carton
 Carton Dimensions - 330*280*270
 Weight - 6Kg

Pallet Dimensions 1100*1100*1550mm
 60 Cartons per Pallet
 12 Cartons per layer
 5 Layers

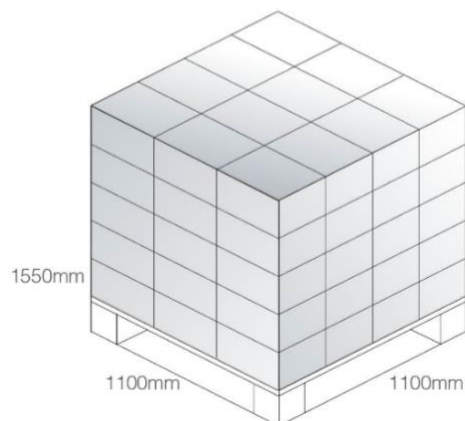

Changelog for the datasheet

SPE-11-8-062– CGGP.35.3.A.02

Revision: N (Current Version)

Date:	2021-06-12
Changes:	Updated Pin Length to 2.4mm Updated Drawing
Changes Made by:	Dan Cantwell

Previous Revisions

Revision: M

Date:	2020-11-23
Changes:	Updated to new format
Changes Made by:	Dan Cantwell

Revision: H

Date:	2015-10-02
Changes:	Added efficiency Rating to cover page
Changes Made by:	Aine Doyle

Revision: L

Date:	2019-04-12
Changes:	Added AR Values
Changes Made by:	David Connolly

Revision: G

Date:	2015-06-01
Changes:	Amended PCB Footprint
Changes Made by:	Aine Doyle

Revision: K

Date:	2019-02-12
Changes:	Amended Drawing
Changes Made by:	Technical Writer

Revision: F

Date:	2014-08-19
Changes:	Removed Circular Polarization data from spec
Changes Made by:	Aine Doyle

Revision: J

Date:	2016-09-09
Changes:	Updated drawing as per PCN
Changes Made by:	Andy Mahoney

Revision: E

Date:	2014-07-04
Changes:	Updated test results
Changes Made by:	Aine Doyle

Revision: I

Date:	2016-05-12
Changes:	Updated Packaging Spec
Changes Made by:	Aine Doyle

Revision: D

Date:	2014-11-06
Changes:	Added EBV information
Changes Made by:	Aine Doyle

Revision: C	
Date:	2013-04-15
Changes:	updated Supplier spec with GND plane info
Changes Made by:	Aine Doyle

Revision: B	
Date:	2011-08-30
Changes:	
Changes Made by:	Technical Writer

Revision: A (Original First Release)	
Date:	2011-07-29
Notes:	
Author:	Technical Writer



TAOGLAS®

www.taoglas.com

