

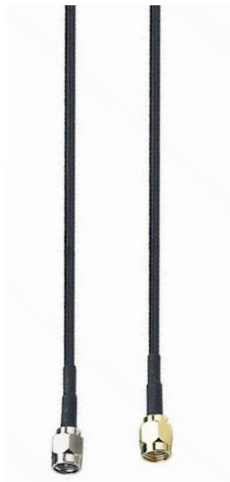

Underside View
(this side faces the passenger)



Top View
(this side faces the sky)

Stingray

MA203w.AB.002

Specification

Part No.	MA.203w.AB.002
Product Name	Stingray GPS/Penta-band Cellular Adhesive Antenna
Feature	High gain LNA up to 32dB (GSM/CDMA/PCS/DCS/UMTS/GPRS/EDGE/ HSPA) Height 10.8mm Diameter 55.1mm Waterproof IP67 Version ROHS Compliant

1. Introduction

This is a combination high performance GPS and Penta-band Cellular (GSM/CDMA/PCS/DCS/ / UMTS / GPRS / EDGE/ HSPA) antenna to simplify AVL or Fleet management antenna systems worldwide.

Its high quality low profile covert housing can be attached onto the glass or even out of sight under the dashboard. This combination of a high gain GPS antenna and a leading edge penta band

cellular antenna is ideal for those applications that require durability, small size and covert installation, and reliable reception and transmission crossing through different mobile networks.

1.1 Features

GPS

High LNA Gain up to 32 dB

Antenna Gain 30 ± 2 dB

Miniaturized to 55.15x12mm

Low Noise 1.5 dB max

Cellular

Advanced Penta-Band Cellular Antenna
(GSM/CDMA/PCS/DCS/UMTS/GPRS/EDGE/HSPA)

Other

Water Resistant IP 67

Quality textured covert design. Low profile

UV resistant ABS housing

Comes with high grade 3M double sided tape for quick and easy mounting

Optional cables and connectors

2. Specification

2.1 Performance Specifications

Items	GPS Patch Antenna	Cellular Antenna
Features	High performance GPS ceramic patch antenna with cutting edge low noise amplifier	CDMA: 824~896MHz DCS: 1710~1880MHz PCS: 1850~1990MHz GSM: 880~960MHz
Centre Frequency	1593MHz ± 2MHz(Free Space)	As above
Gain	-3.0dB typ. Axial Ratio :2.0 dB max	As patterns
Polarization	RHCP	
Bandwidth	10 MHz min	
VSWR	1.92 Max.	
Impedance	50Ω	50Ω
Cable / Connector	Standard 1/2/3/5/10mRG-174 Cables and Connectors Fully Customizable	Standard 1/2/3/5/10mRG-174 Cables and Connectors Fully Customizable
Return Loss		10dB Typ
Size	59.8mm * 16mm	
Housing	UV resistant ABS	

*Note: Specifications may be subject to change

2.2 LNA GPS Antenna

Parameter	Specification
Frequency (MHz)	1575.42 ± 1.023MHz
Gain	28dB Typical
Output Impedance	50Ω
Output VSWR	1.92 Max
DC Power Input	2.7-3.3V
Noise Figure	1.5dB Typ.
Power Consumption	6mA

3. GPS Ceramic Patch Antenna

3.1 Free Space



3. GPS Ceramic Patch Antenna

3.2 With Housing, Glass Mount



4. GSM Radiation Patterns

XZ Plane

YZ Plane

880 MHz

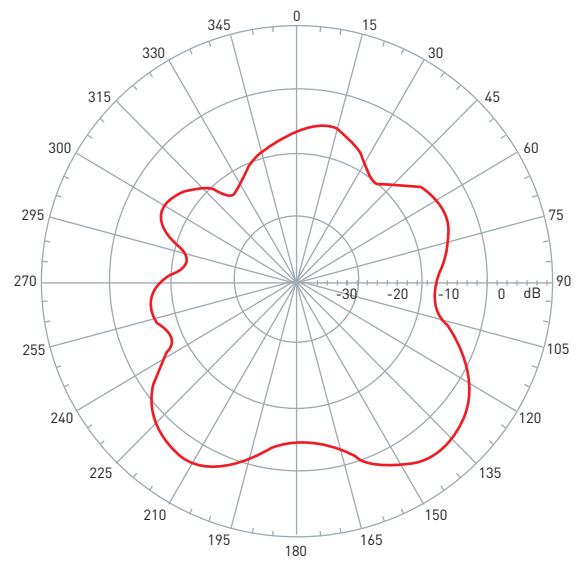
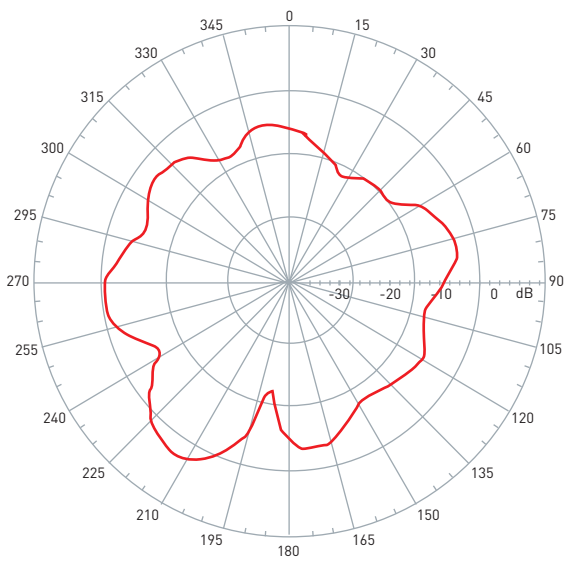

960 MHz

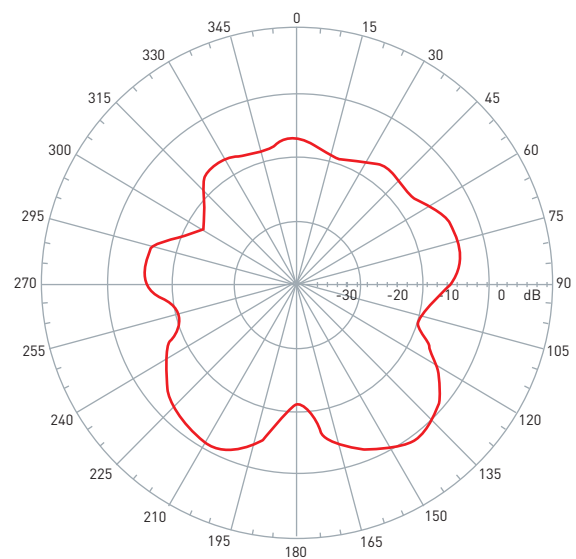
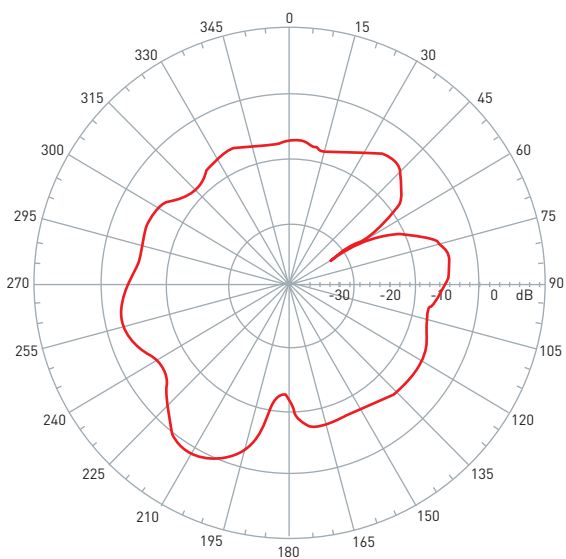

4. GSM Radiation Patterns

XZ Plane

YZ Plane

1710 MHz

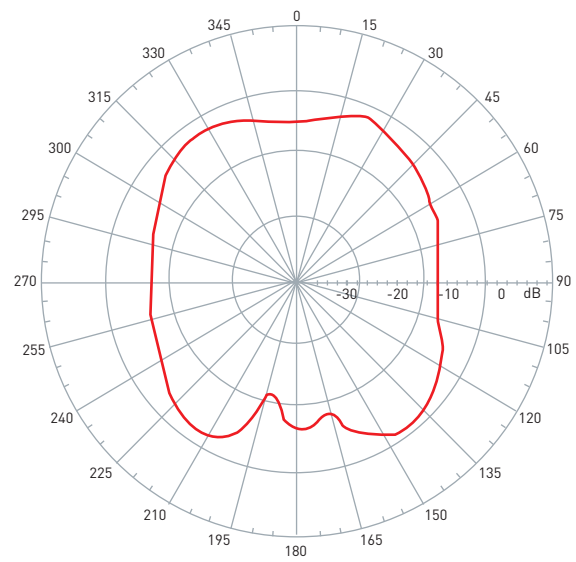
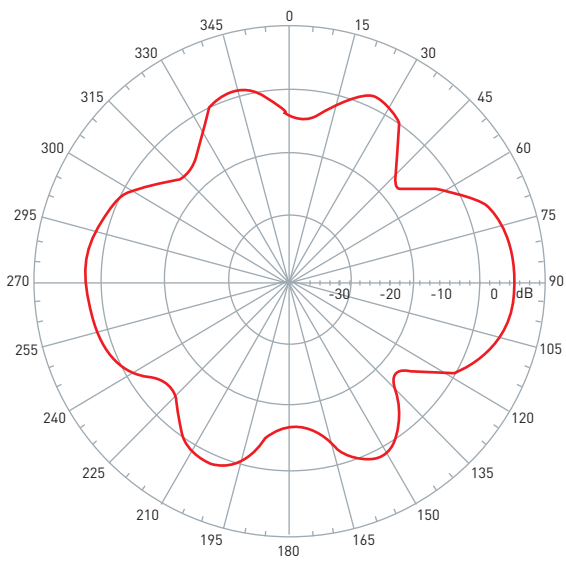

1880 MHz

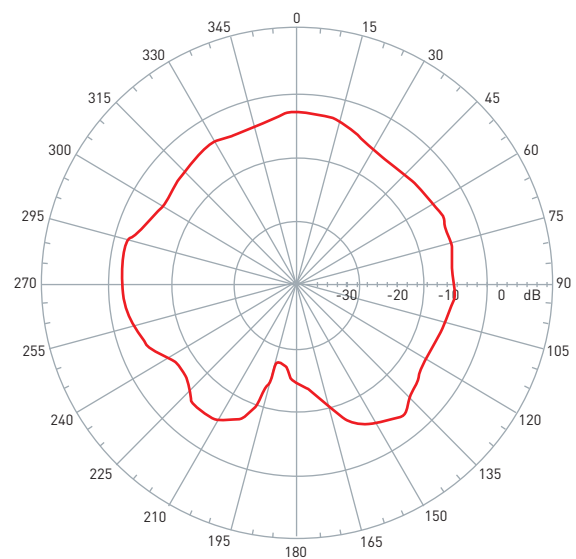
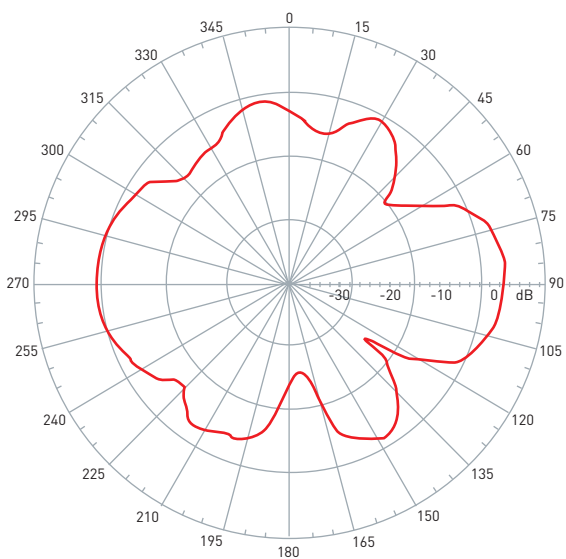

5. GSM Antenna Return Loss

5.1 Free Space



5. GSM Antenna Return Loss

5.2 With Housing, Glass Mount



6. Drawings

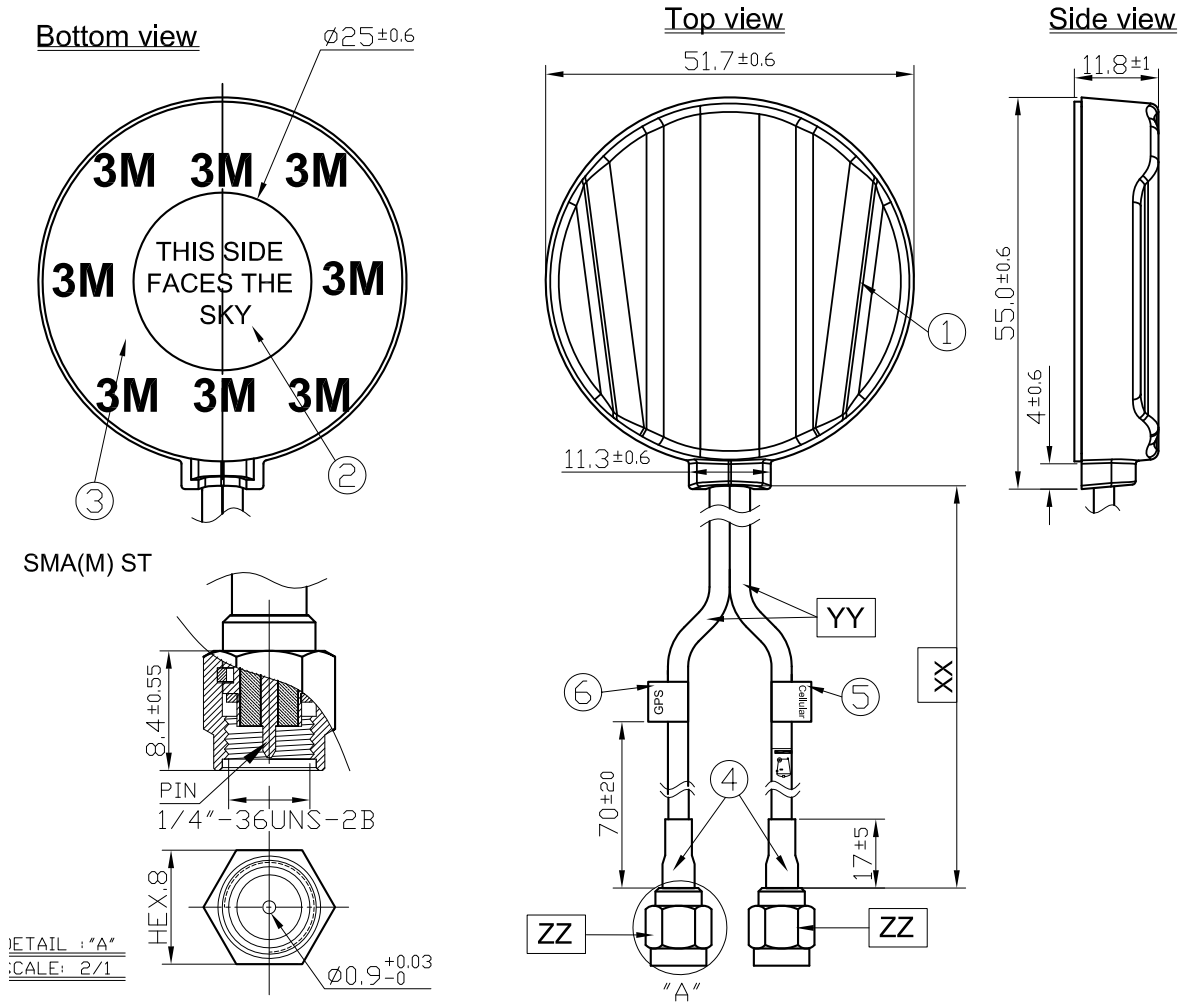

	Name	Material	Finish	QTY
1	Housing	ABS	Black	1
2	Round Label	Art Paper	White	1
3	Scotch Brand Acrylic Foam Tape	3M 4612	White Liner	1
4	Heat Shrink Tube	PE	Black	2
5	Cellular Label	Coated Paper	Blue	1
6	GPS Label	Coated Paper	Orange	1

	Name	Spec	Finish	QTY
XX	Cable Length	3000mm ± 30mm		1
YY	Cable Type	RG174	Black	2
ZZ	Connector Type	SMA(M) ST	Gold	2

7. Packaging

1 pcs antenna per small PE bag

80 small PE bag per box

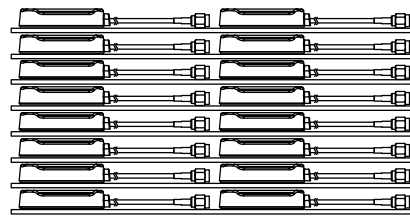
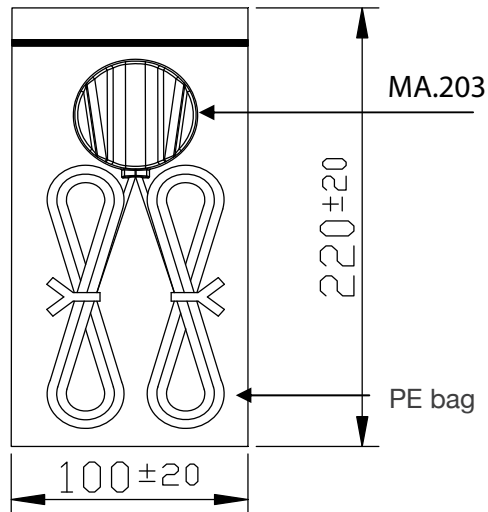

← 10 pcs/pad

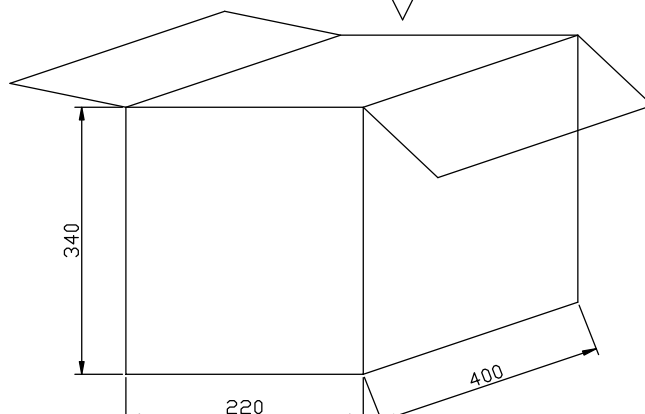

← 80 pcs per carton

Taoglas makes no warranties based on the accuracy or completeness of the contents of this document and reserves the right to make changes to specifications and

product descriptions at any time without notice.

Taoglas reserves all rights to this document and the information contained herein.

Reproduction, use or disclosure to third parties without express permission is strictly prohibited.

Copyright © Taoglas Ltd.