

## SPECIFICATION

- Part No. : **GSA.8841.A.105111**
- Product Name : Wideband 4G LTE I-Bar Antenna  
698MHZ to 6000MHz
- Features : LTE / GSM / CDMA / DCS / PCS / WCDMA /  
UMTS / HSDPA / GPRS / EDGE / GPS / Wi-Fi  
176mm \* 59mm \*11.6mm  
698MHz to 960MHz, 1575.42MHz  
1710MHz to 2700Mhz  
5150MHz to 5850MHz  
With 1M NFC-200 and SMA(M) Connector  
**RoHS Compliant**



## 1. Introduction

The GSA.8841 LTE Wideband I-Bar Antenna is an external adhesive mount solution on glass and plastic for automotive and telematics applications. It covers not only LTE, but all Cellular, ISM and Wi-Fi working frequencies in the 700-6000 MHz spectrum. It has the highest wide-band efficiency in its range of any antenna in its category today.

The GSA.8841 has been primarily designed for use with 4G LTE modules and devices that require the highest possible efficiency and peak gain to deliver best in class throughput on all major cellular 4G bands worldwide for telematics applications.

- High speed HD video
- Real-time streaming
- High capacity MIMO networks on public transportation

It comes with 1 meter of coaxial cable and SMA (M) connector, in a low profile compact format for mounting via high quality first tier automotive approved 3M adhesive foam. Stable radiation is observed on both glass and plastic.

The GSA.8841 is backward compatible with 3G and 2G cellular applications such as HSPA, as well as covering WI-FI bands, and even has GPS included for E911 applications.

It is an ideal solution for any device requiring high, reliable performance. It will meet nearly all carrier certification requirements from an efficiency standpoint. The antenna also makes an excellent reference antenna for test purposes. It has been designed as an omni-directional antenna and the radiation patterns show this and are stable across all bands.

## 2. Specification

ELECTRICAL									
Standard	LTE/GSM/ CDMA 700/800/ 850/900	GNSS	LTE/GSM/ HSPA/CDMA 1700/1800/ 1900	UMTS/ HSPA 2100	LTE 2300	Wi-Fi 2400	LTE 2600	LTE 3500	Wi-Fi 5800
Frequency (MHz)	698~960	1565 ~1612	1710 ~1990	1920 ~2170	2305 ~2360	2400 ~2500	2500 ~2700	3400 ~3600	4800~6000
Efficiency (%)									
In free space	30cm	71.88	62.03	67.62	67.81		68.79	71.08	48.73
	1M	68.64	56.57	61.77	62.39		62.74	64.83	43.43
	2M	63.75	51.59	55.33	56.02		54.64	55.89	36.76
	3M	59.34	45.98	48.75	49.59		47.06	47.47	30.75
	5M	50.54	36.53	37.87	39.04		36.10	36.30	22.34
On the 2mm ABS Base	30cm	74.99	64.23	70.69	70.33		69.68	73.11	49.39
	1M	71.62	58.58	64.58	64.68		63.55	66.67	44.02
	2M	66.53	53.42	57.85	58.07		55.35	57.49	37.25
	3M	61.93	47.61	50.97	51.41		47.67	48.82	31.16
	5M	52.78	37.82	39.60	40.45		36.57	37.33	22.63
On the Glass Base	30cm	74.73	73.00	80.37	77.79		64.27	69.10	55.18
	1M	71.86	66.58	73.41	71.51		58.62	63.02	49.18
	2M	67.23	60.72	65.79	64.21		51.05	54.33	41.44
	3M	64.50	54.12	57.94	56.81		43.97	46.14	34.81
	5M	55.06	42.99	45.03	44.67		33.73	35.28	24.97
Average Gain(dBi)									
In free space	30cm	-1.46	-2.08	-1.72	-1.71		-1.63	-1.49	-3.22
	1M	-1.66	-2.48	-2.12	-2.07		-2.03	-1.89	-3.72
	2M	-1.98	-2.88	-2.59	-2.54		-2.63	-2.53	-4.45
	3M	-2.29	-3.38	-3.14	-3.07		-3.28	-3.24	-5.22
	5M	-2.99	-4.38	-4.23	-4.11		-4.43	-4.41	-6.62
On the 2mm ABS Base	30cm	-1.29	-1.93	-1.52	-1.55		-1.57	-1.37	-3.13
	1M	-1.49	-2.33	-1.92	-1.91		-1.97	-1.77	-3.63
	2M	-1.81	-2.73	-2.39	-2.38		-2.57	-2.41	-4.37
	3M	-2.12	-3.23	-2.94	-2.91		-3.22	-3.12	-5.13
	5M	-2.82	-4.23	-4.04	-3.95		-4.37	-4.28	-6.53
On the Glass Base	30cm	-1.33	-1.37	-0.96	-1.11		-1.92	-1.62	-2.62
	1M	-1.50	-1.77	-1.35	-1.47		-2.32	-2.02	-3.12
	2M	-1.80	-2.17	-1.83	-1.94		-2.92	-2.66	-3.87
	3M	-2.02	-2.67	-2.38	-2.47		-3.57	-3.37	-4.62
	5M	-2.72	-3.67	-3.47	-3.51		-4.72	-4.53	-6.07

Peak Gain(dBi)									
Standard	LTE/GSM /CDMA 700/800/850/900	GNSS	LTE/GSM/HS PA/CDMA 1700/1800/1900	UMTS/ HSPA 2100	LTE 2300	Wi-Fi 2400	LTE 2600	LTE 3500	Wi-Fi 5800
Frequency (MHz)	698~960	1565~1612	1710~1990	1920~2170	2305 ~2360	2400~2500	2500~2700	3400 ~3600	4800~6000
In free space	30cm	1.56	1.38	3.79	3.06		4.25	4.70	2.56
	1M	1.36	0.98	3.40	2.69		3.85	4.30	2.06
	2M	1.04	0.58	2.92	2.23		3.25	3.66	1.33
	3M	0.73	0.08	2.37	1.70		2.60	2.95	0.56
	5M	0.03	-0.92	1.28	0.66		1.45	1.79	-0.84
On the 2mm ABS Base	30cm	1.65	1.74	3.85	3.13		5.00	5.27	2.08
	1M	1.45	1.34	3.46	2.76		4.60	4.87	1.58
	2M	1.13	0.94	2.99	2.30		4.00	4.23	0.84
	3M	0.81	0.44	2.44	1.77		3.35	3.52	0.08
	5M	0.11	-0.56	1.34	0.73		2.20	2.35	-1.32
On the Glass Base	30cm	1.52	3.20	4.76	4.12		5.75	5.35	4.14
	1M	1.32	2.80	4.37	3.76		5.35	4.95	3.64
	2M	0.99	2.40	3.89	3.29		4.75	4.31	2.89
	3M	0.68	1.90	3.34	2.76		4.10	3.60	2.14
	5M	-0.02	0.90	2.25	1.72		2.95	2.44	0.69
Impedance		50Ω							
Polarization		Linear							
Radiation Pattern		Omni							
Input Power		5 W							
MECHANICAL									
Casing		ABS							
Coaxial Cable		NFC-200 Low Loss Cable							
Cable Length		1 Meter Standard, Fully Customizable							
Connector		SMA Male Standard, Fully Customizable							
Adhesive		3M9448+CR4305 Double Sided Adhesive							
Weight		127g							
ENVIRONMENTAL									
Operation Temperature Range		-40°C to 85°C							
Storage Temperature Range		-40°C to 85°C							
Humidity		Non-condensing 65°C 95% RH							

LTE BANDS			
Band Number	LTE / LTE-Advanced / WCDMA / HSPA / HSPA+ / TD-SCDMA		
	Uplink	Downlink	Covered
1	UL: 1920 to 1980	DL: 2110 to 2170	✓
2	UL: 1850 to 1910	DL: 1930 to 1990	✓
3	UL: 1710 to 1785	DL: 1805 to 1880	✓
4	UL: 1710 to 1755	DL: 2110 to 2155	✓
5	UL: 824 to 849	DL: 869 to 894	✓
7	UL: 2500 to 2570	DL: 2620 to 2690	✓
8	UL: 880 to 915	DL: 925 to 960	✓
9	UL: 1749.9 to 1784.9	DL: 1844.9 to 1879.9	✓
11	UL: 1427.9 to 1447.9	DL: 1475.9 to 1495.9	✗
12	UL: 699 to 716	DL: 729 to 746	✓
13	UL: 777 to 787	DL: 746 to 756	✓
14	UL: 788 to 798	DL: 758 to 768	✓
17	UL: 704 to 716	DL: 734 to 746 (LTE only)	✓
18	UL: 815 to 830	DL: 860 to 875 (LTE only)	✓
19	UL: 830 to 845	DL: 875 to 890	✓
20	UL: 832 to 862	DL: 791 to 821	✓
21	UL: 1447.9 to 1462.9	DL: 1495.9 to 1510.9	✗
22	UL: 3410 to 3490	DL: 3510 to 3590	✗
23	UL: 2000 to 2020	DL: 2180 to 2200 (LTE only)	✓
24	UL: 1625.5 to 1660.5	DL: 1525 to 1559 (LTE only)	✓
25	UL: 1850 to 1915	DL: 1930 to 1995	✓
26	UL: 814 to 849	DL: 859 to 894	✓
27	UL: 807 to 824	DL: 852 to 869 (LTE only)	✓
28	UL: 703 to 748	DL: 758 to 803 (LTE only)	✓
29	UL: -	DL: 717 to 728 (LTE only)	✓
30	UL: 2305 to 2315	DL: 2350 to 2360 (LTE only)	✓
31	UL: 452.5 to 457.5	DL: 462.5 to 467.5 (LTE only)	✗
32	UL: -	DL: 1452 - 1496	✗
35		1850 to 1910	✓
38		2570 to 2620	✓
39		1880 to 1920	✓
40		2300 to 2400	✓
41		2496 to 2690	✓
42		3400 to 3600	✓
43		3600 to 3800	✗

\*Covered bands represent an efficiency greater than 20%

## 3. Antenna Characteristics

### 3.1. Testing setup



In free space



On 2mm ABS Base



On Glass Base

**Figure.1** Test setup; a) In free space, b) On 2mm ABS Base, c) On the Glass Base

### 3.2. Return loss

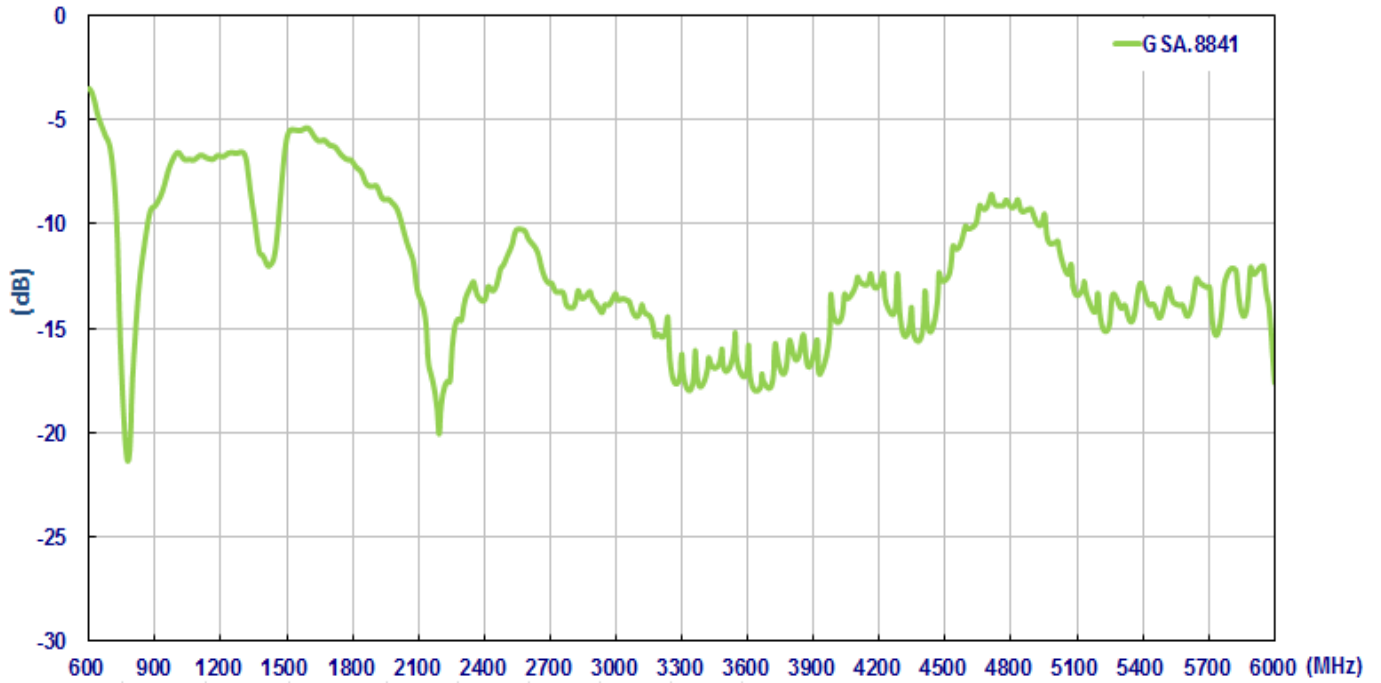


Figure2. Return loss of GSA.8841 with 1 meter cable length in free space

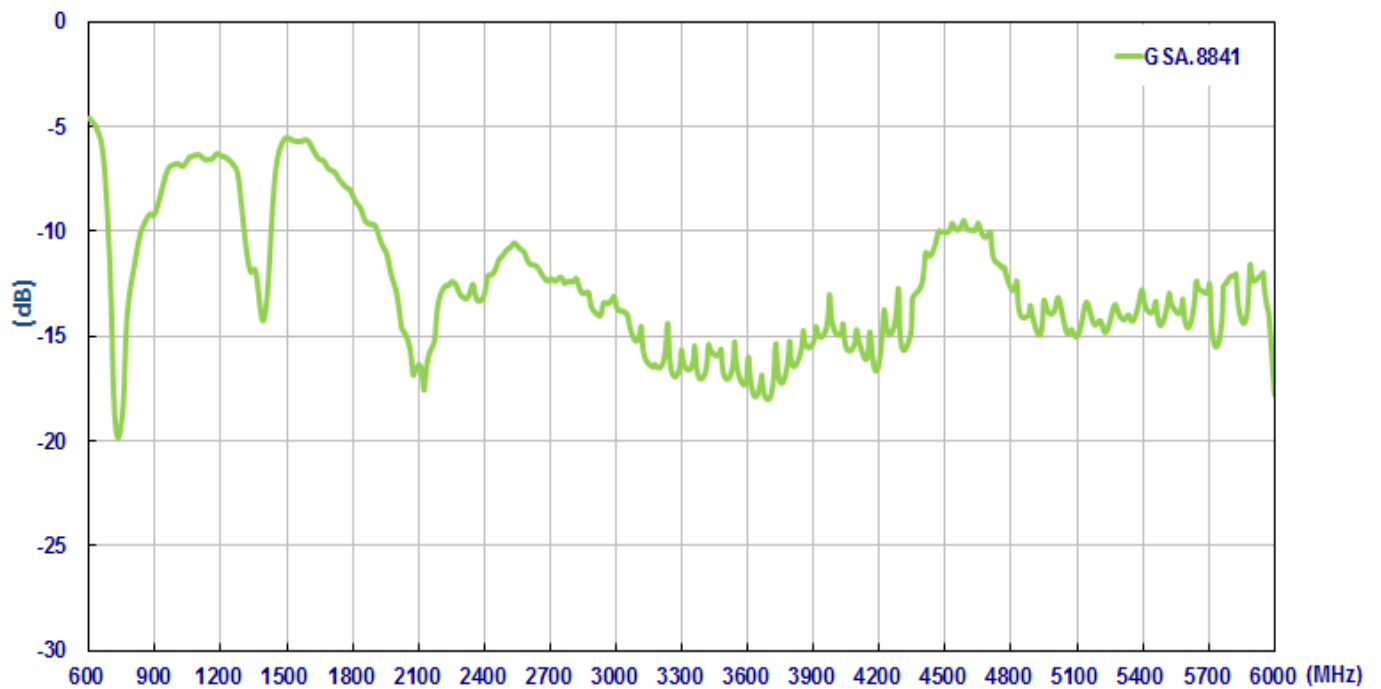
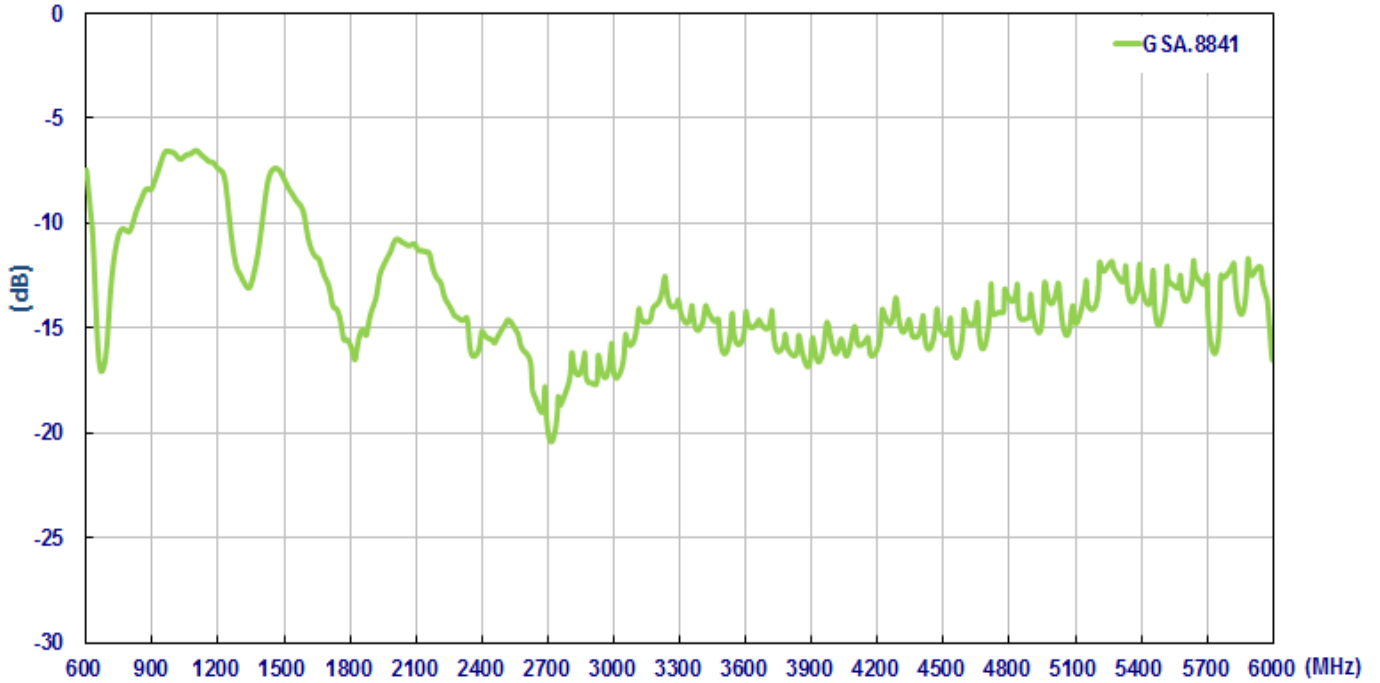
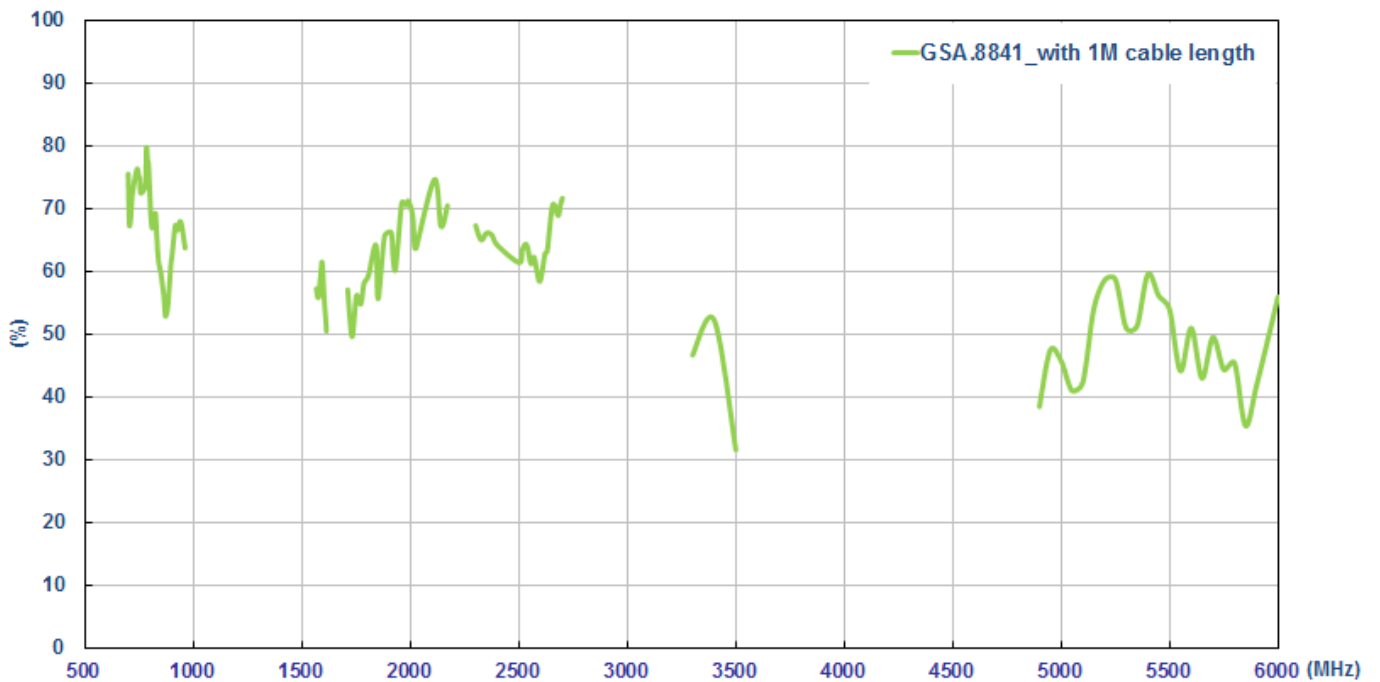


Figure3. Return loss of GSA.8841 with 1 meter cable length on the 2mm ABS base



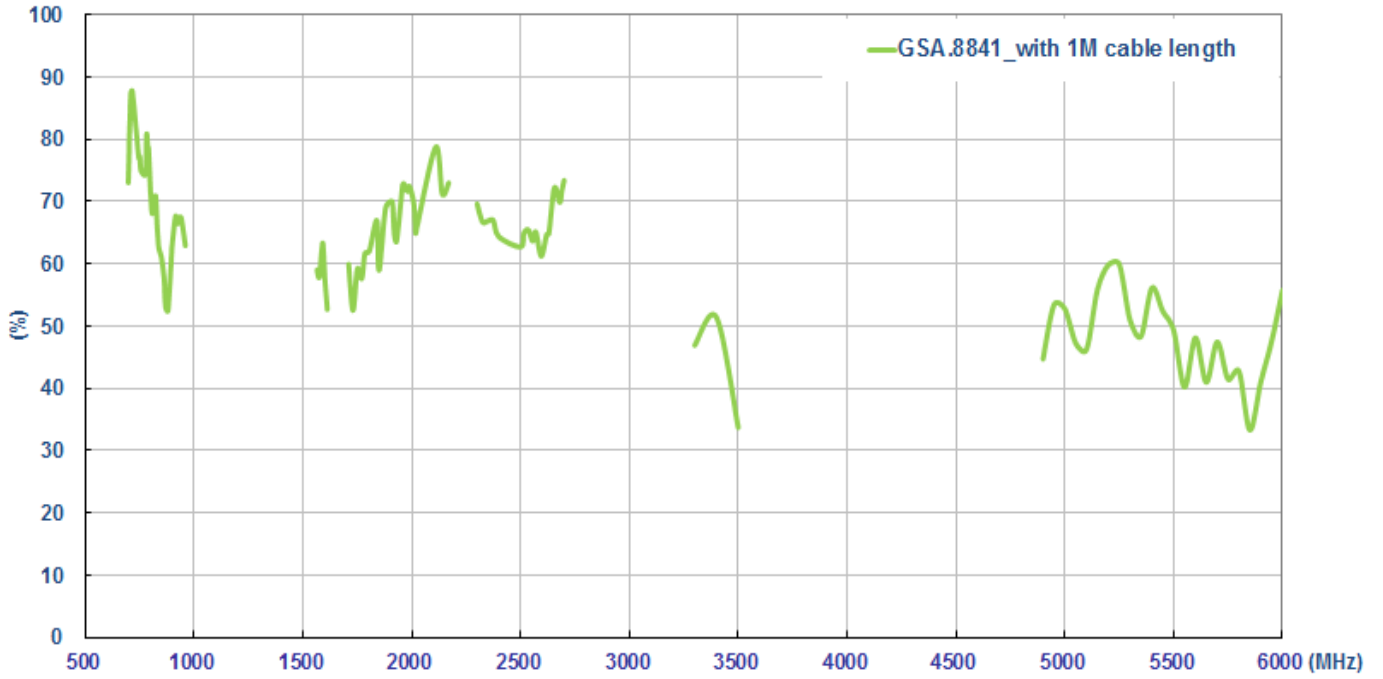
**Figure4.** Return loss of GSA.8841 with 1 meter cable length on the glass base

### 3.3 Efficiency

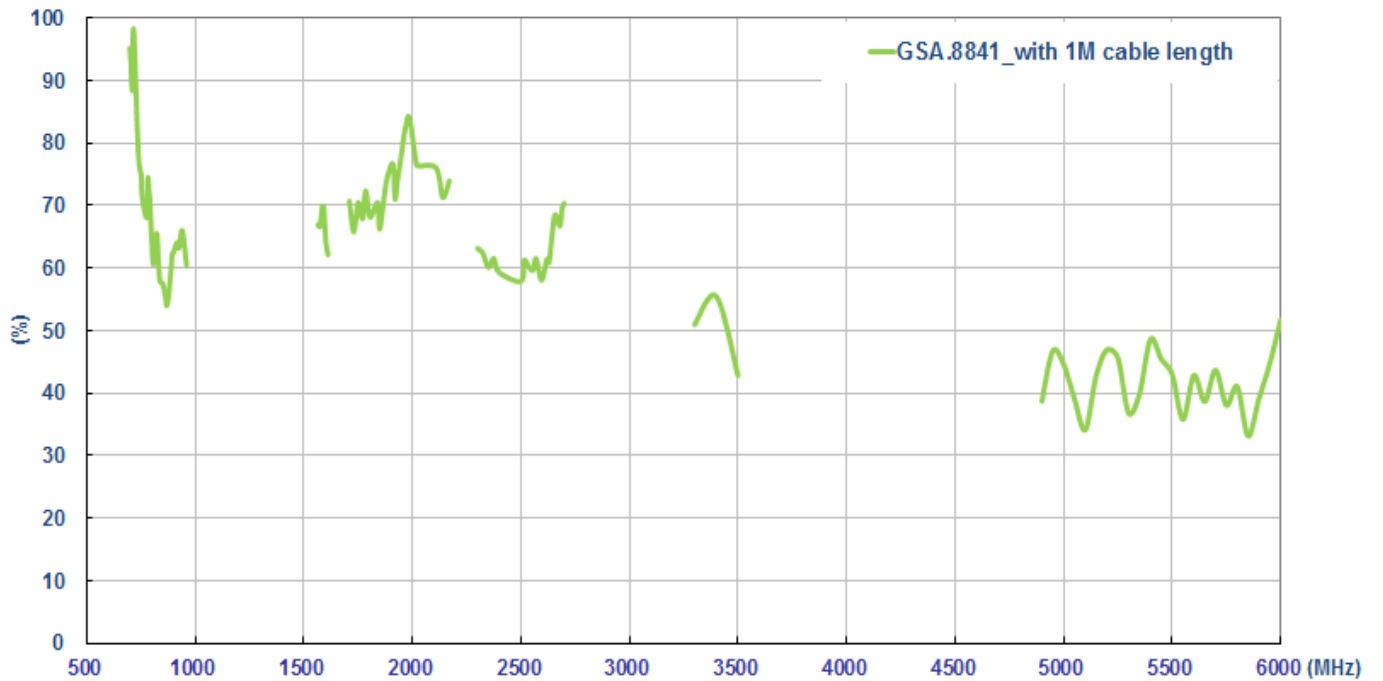


**Figure5.** Efficiency of GSA.8841 with 1 meter cable length in free space





**Figure6.** Efficiency of GSA.8841 with 1 meter cable length on the 2mm ABS base



**Figure7.** Efficiency of GSA.8841 with 1 meter cable length on the glass base

### 3.4 Peak gain

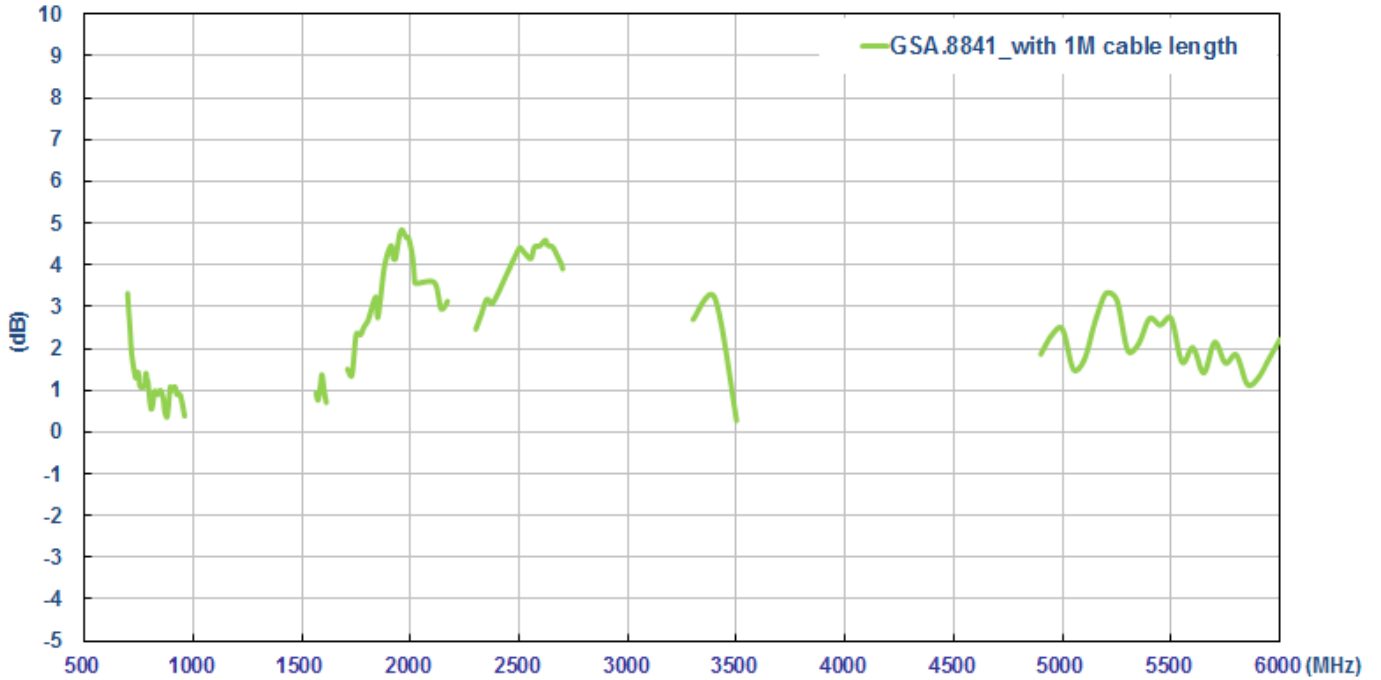


Figure8. Peak gain of GSA.8841 with 1 meter cable length in free space

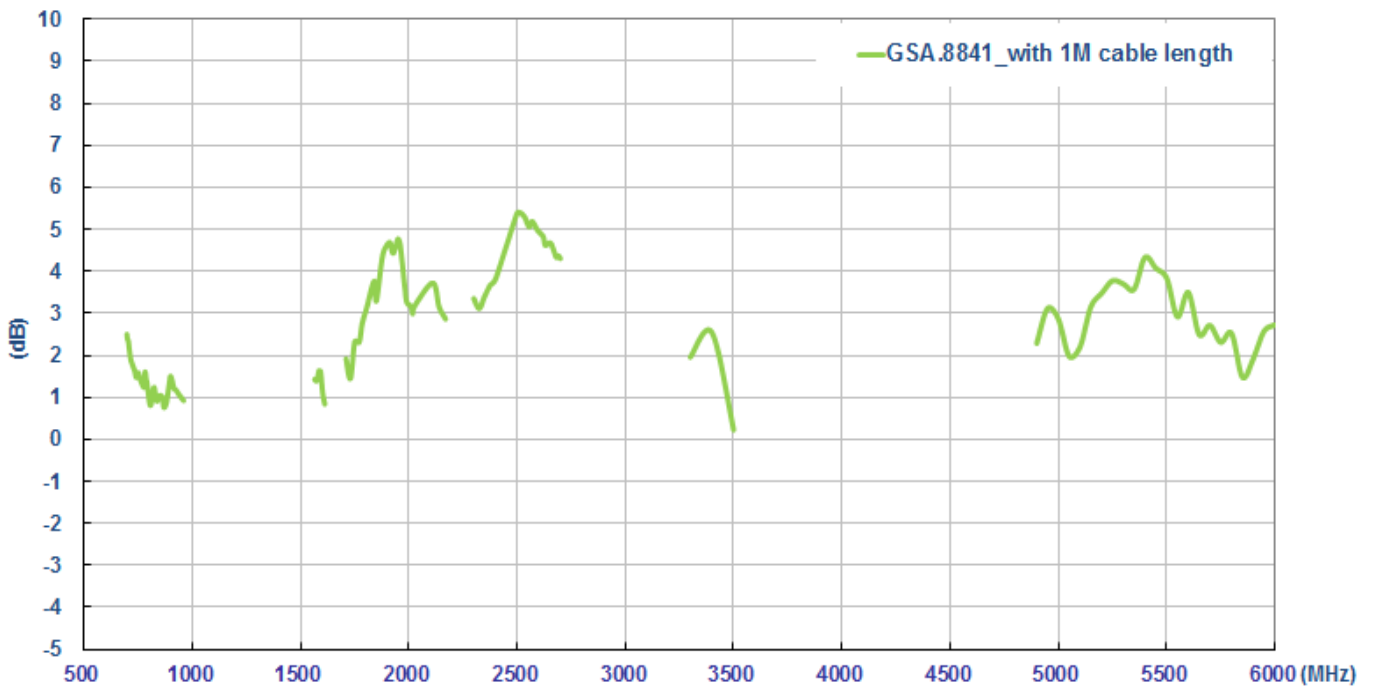
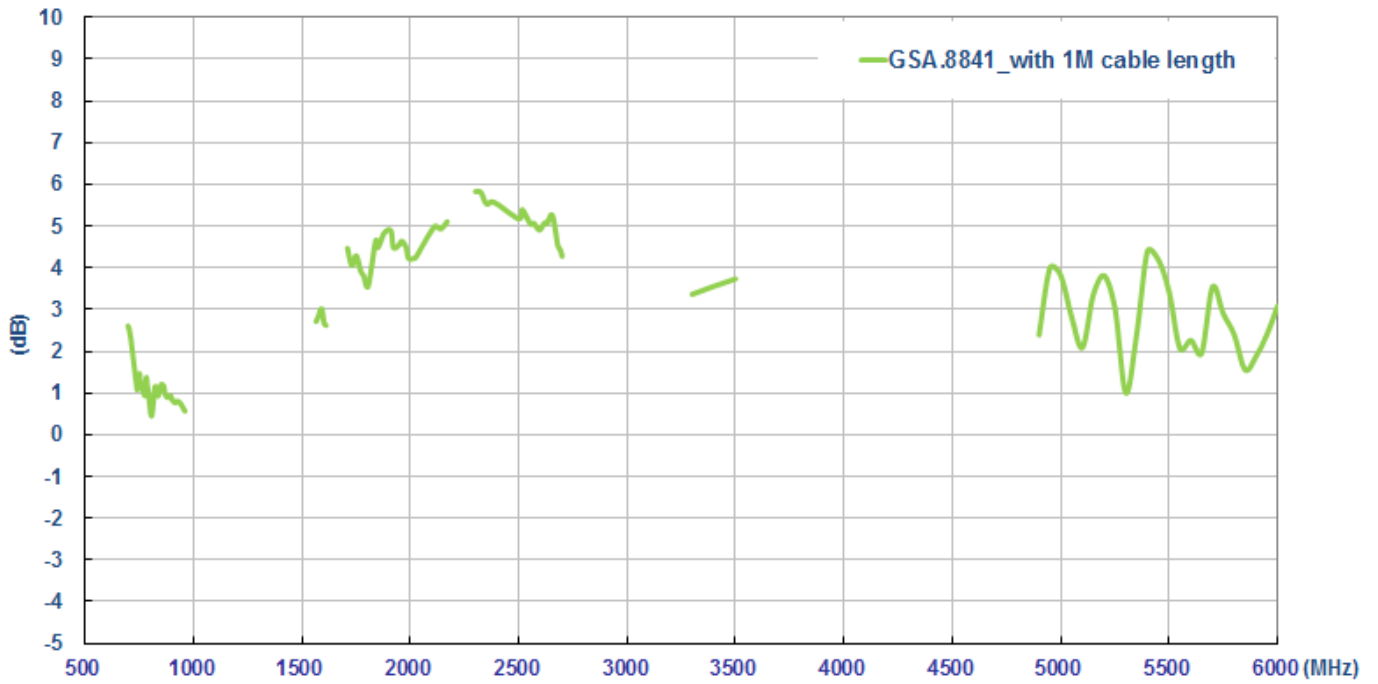
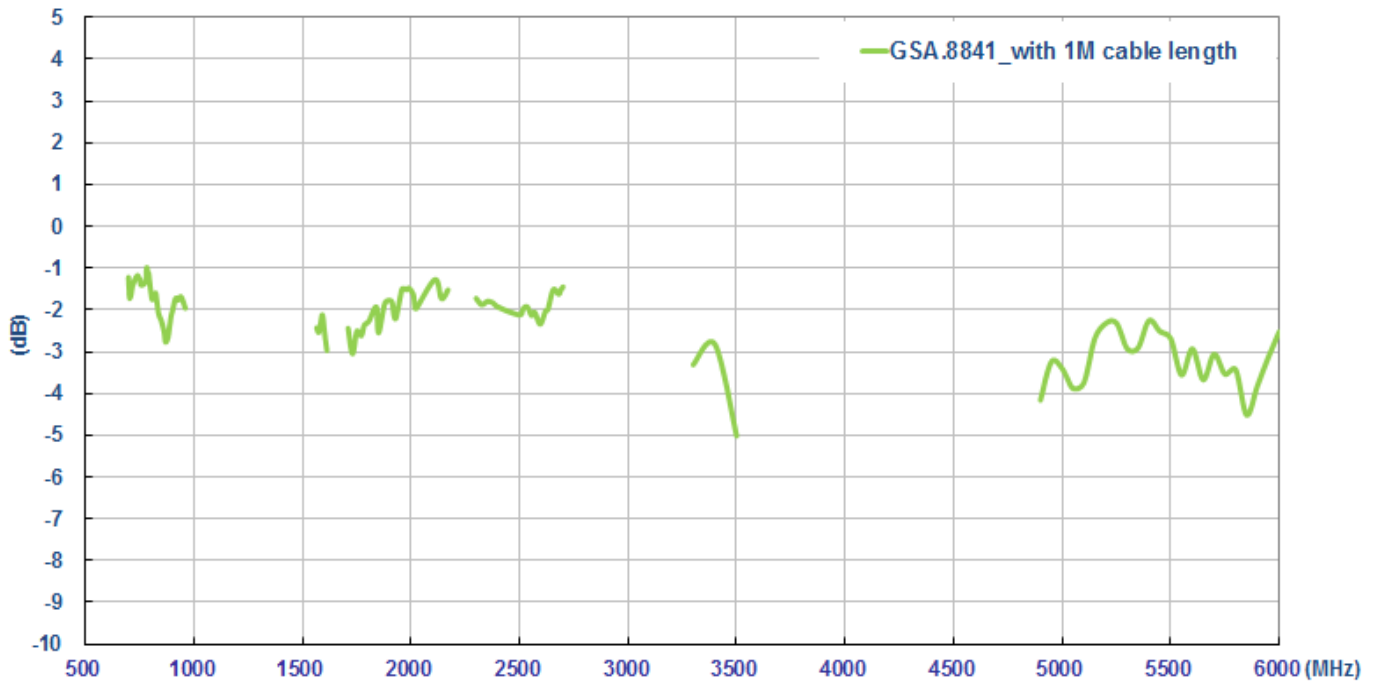


Figure9. Peak gain of GSA.8841 with 1 meter cable length on the 2mm ABS base

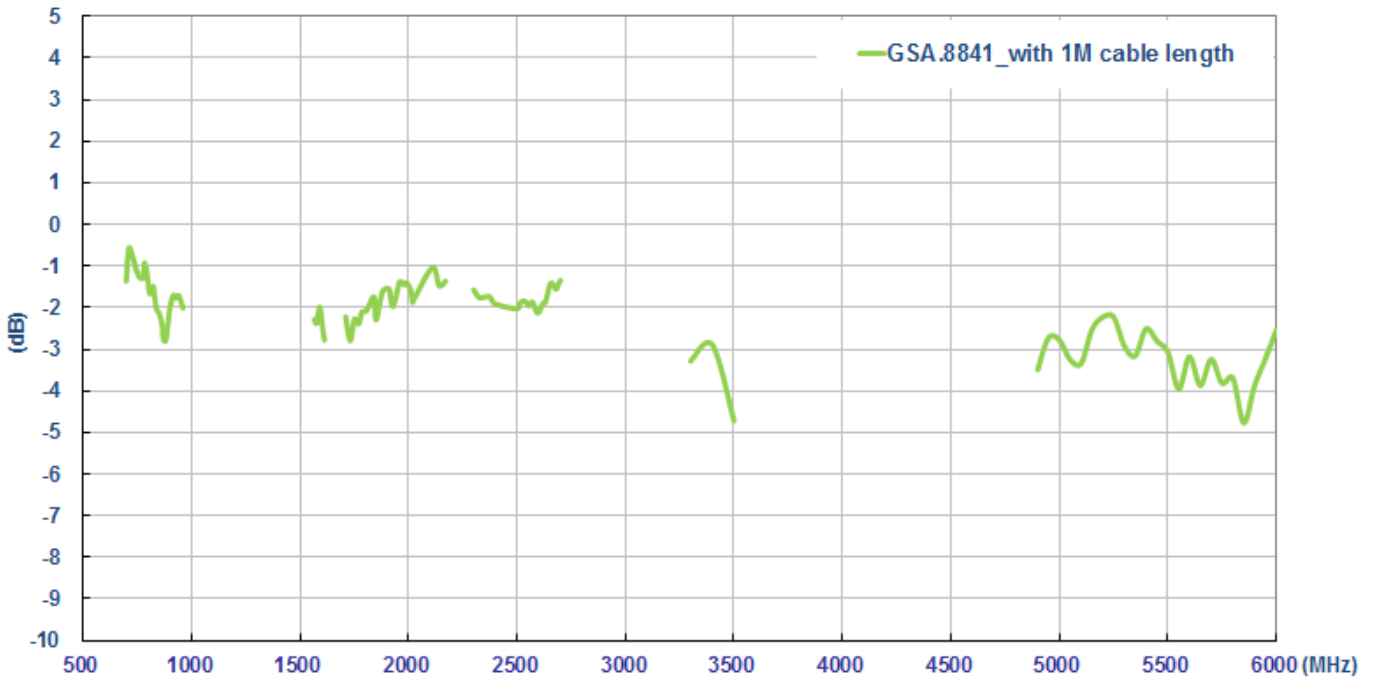


**Figure10.** Peak gain of GSA.8841 with 1 meter cable length on the glass base

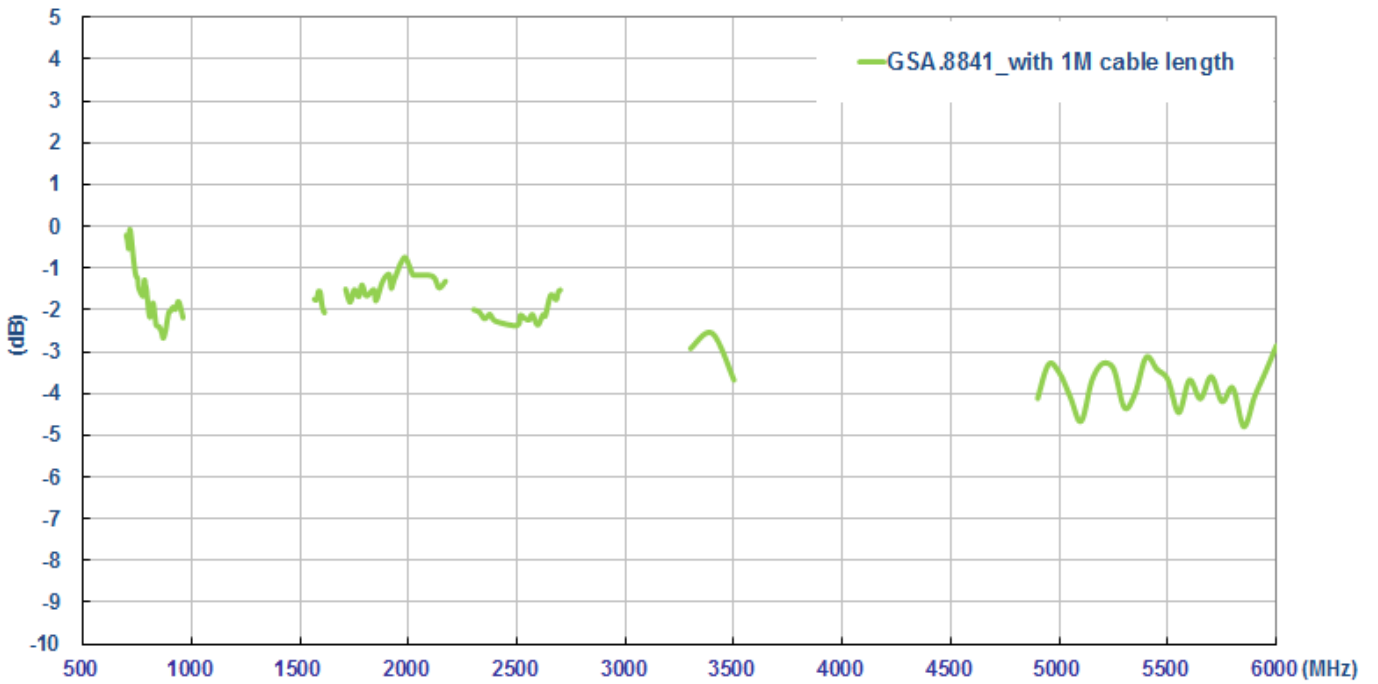
### 3.5 Average gain



**Figure11.** Average gain of GSA.8841 with 1 meter cable length in free space



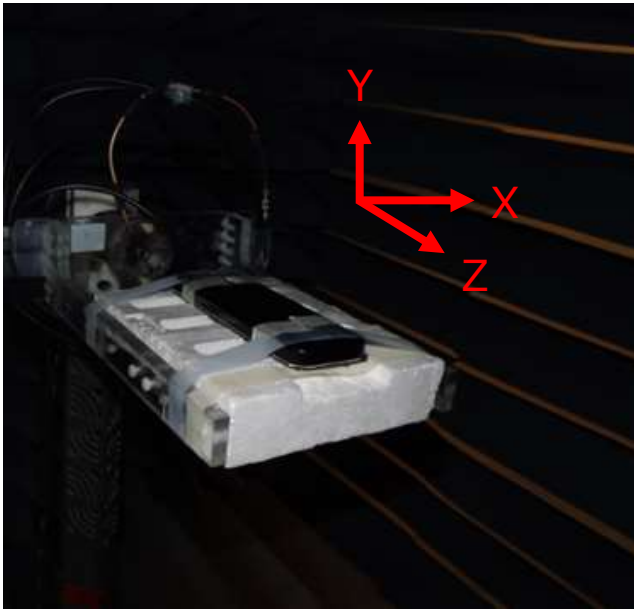
**Figure12.** Average gain of GSA.8841 with 1 meter cable length on the 2mm ABS base



**Figure13.** Average gain of GSA.8841 with 1 meter cable length on the glass base

## 4. Antenna Radiation Patterns

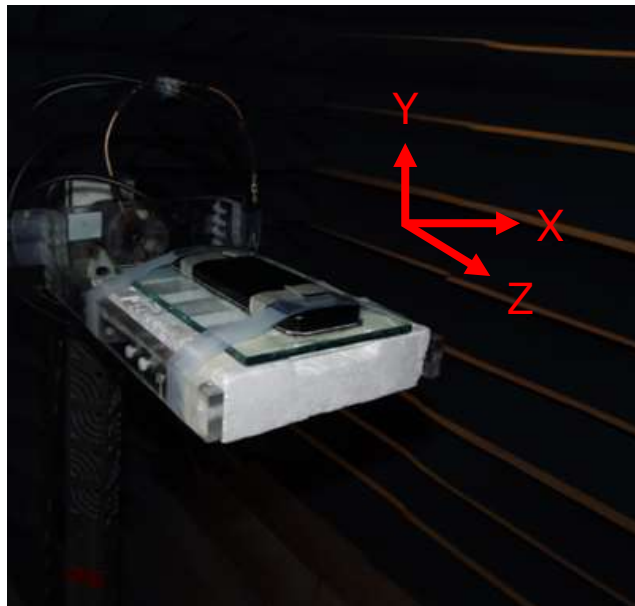
The antenna radiation patterns were measured in ETS Anechoic Chamber. The measurement setup as below,



In free space



On 2mm ABS base

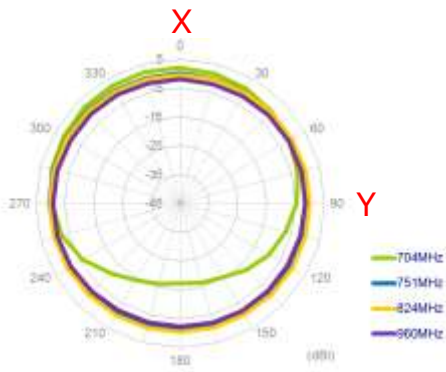


3) On the glass base

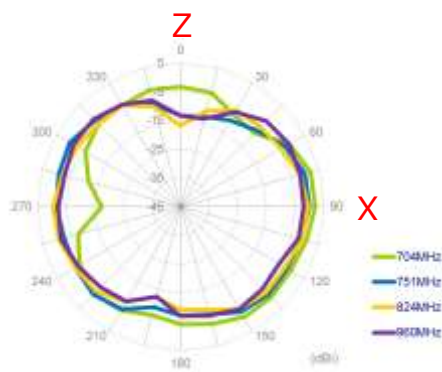
**Figure.14** The measurement setup; a) In free space, b) On the 2mm ABS base, c) On the glass base

### 4.1. 1 Meter Cable in Free Space

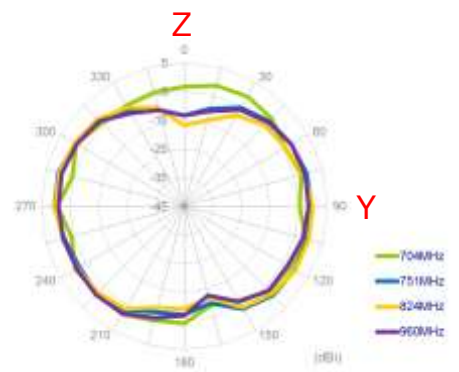
XY Plane



XZ Plane



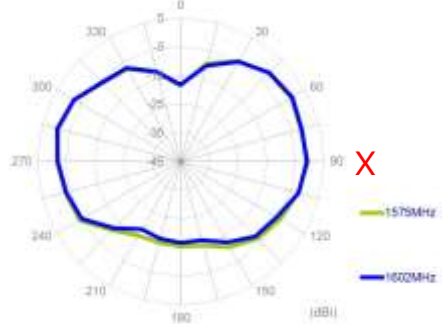
YZ Plane



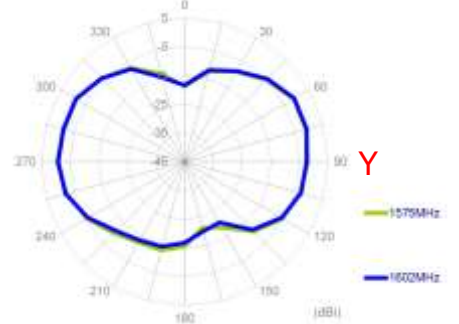
X



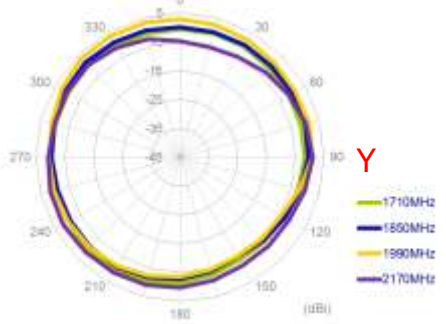
Z



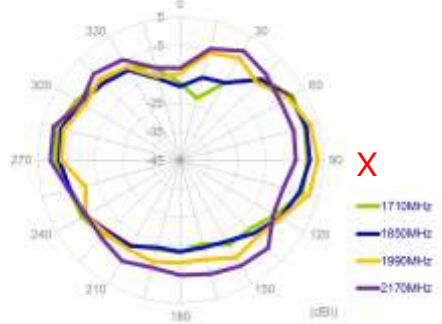
Z



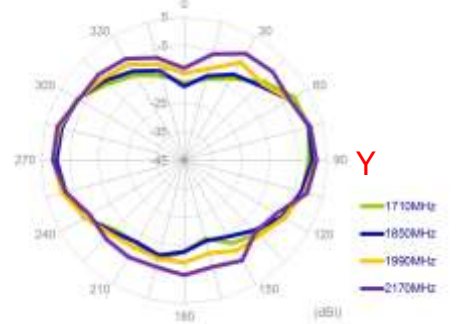
X



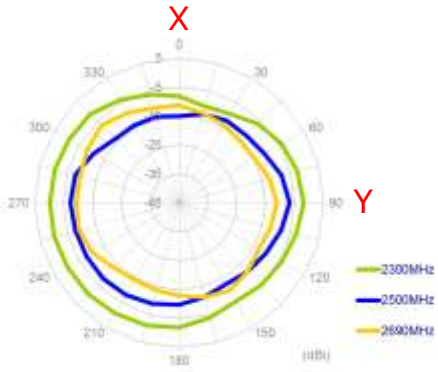
Z



Z



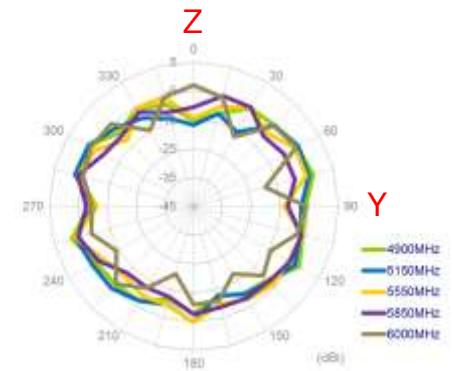
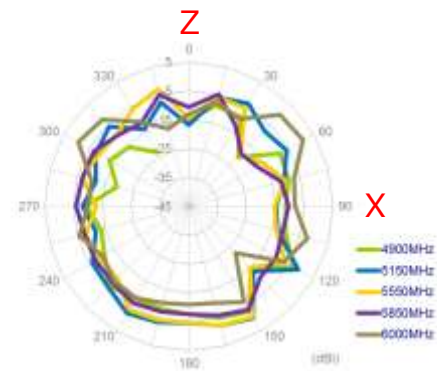
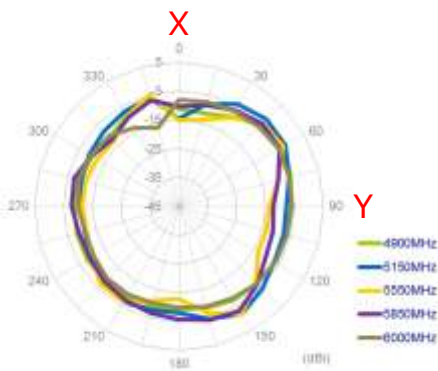
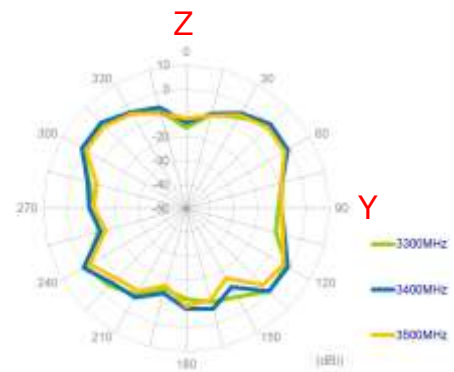
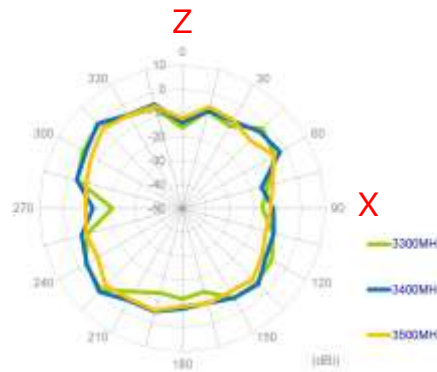
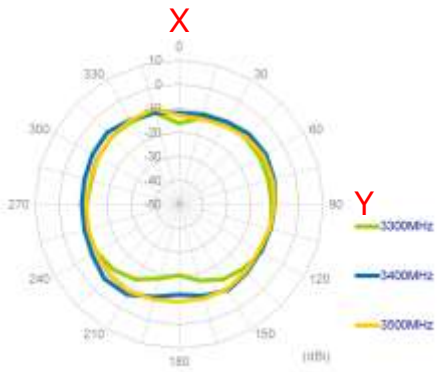
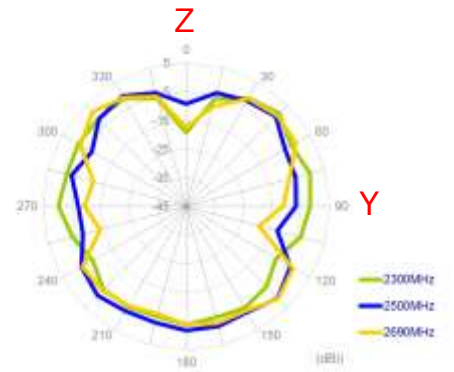
XY Plane



XZ Plane

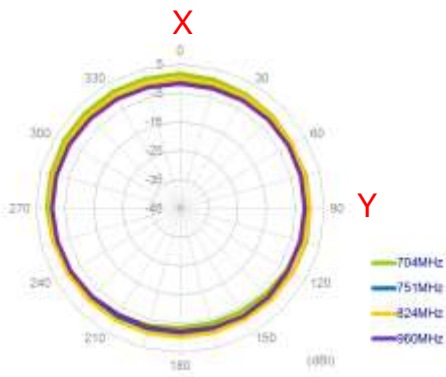


YZ Plane

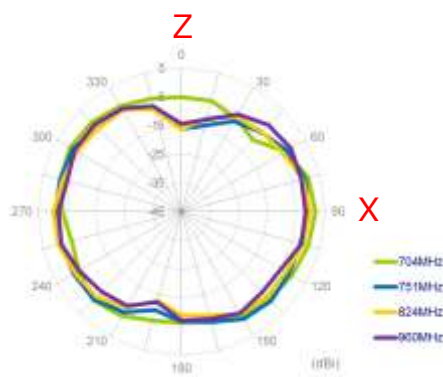


## 4.2. 1 Meter Cable Length on 2mm ABS Base

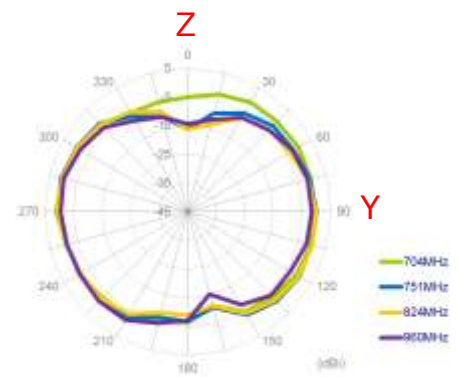
XY Plane



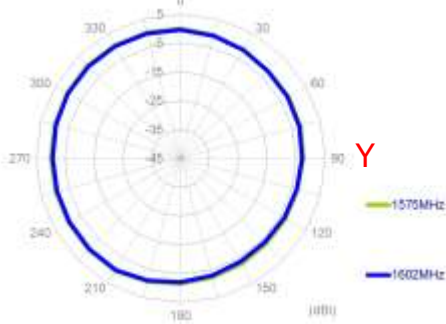
XZ Plane



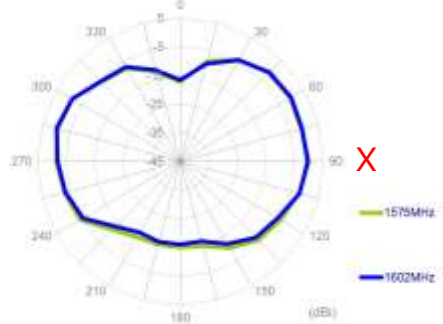
YZ Plane



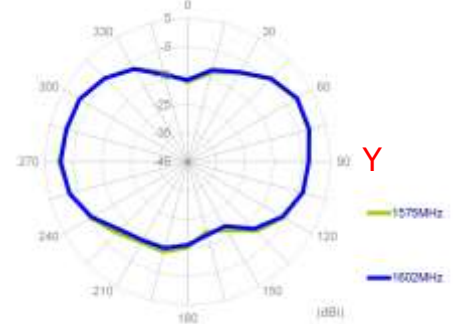
X



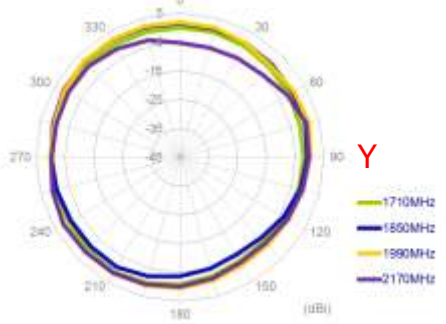
Z



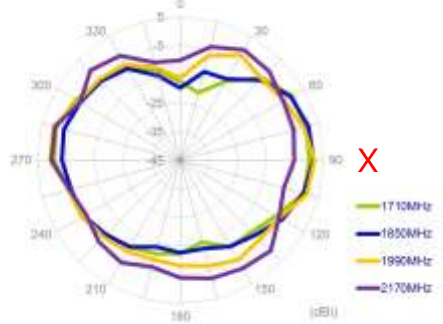
Z



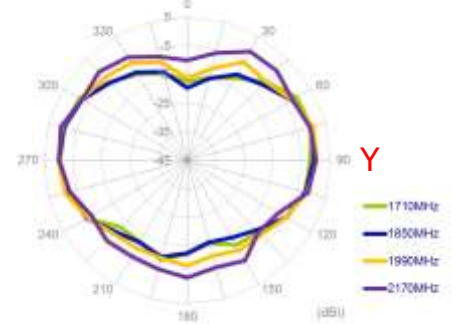
X



Z

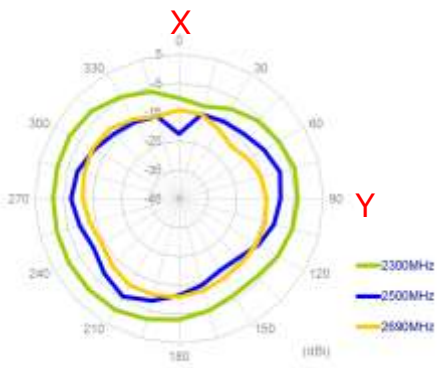


Z





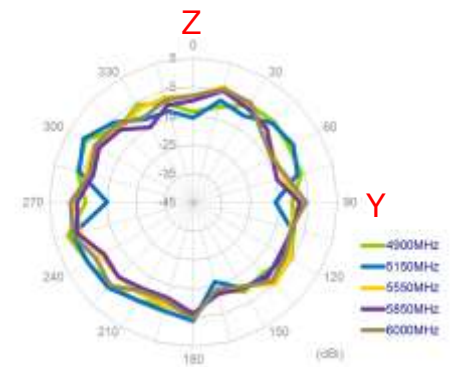
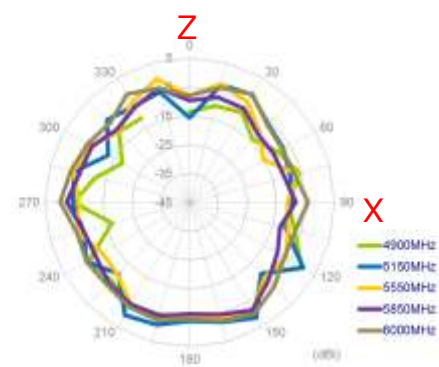
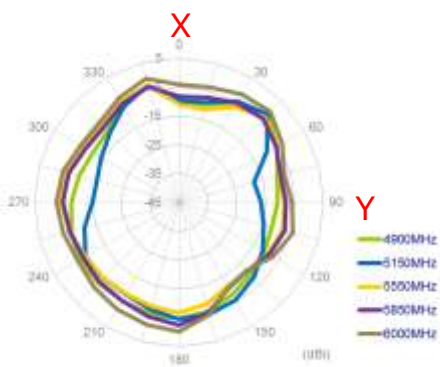
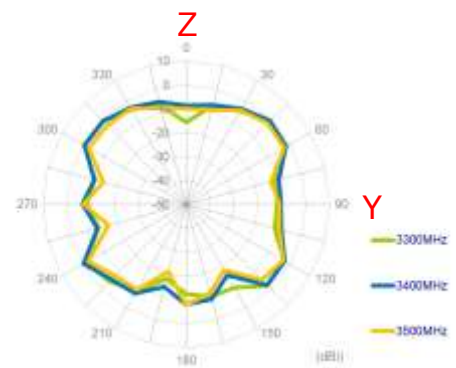
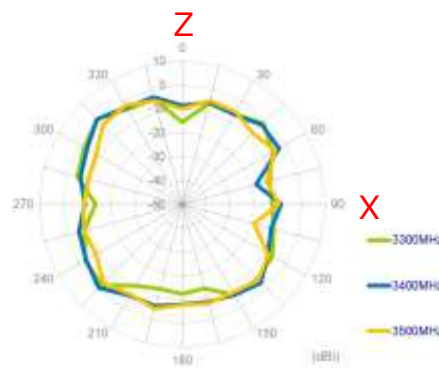
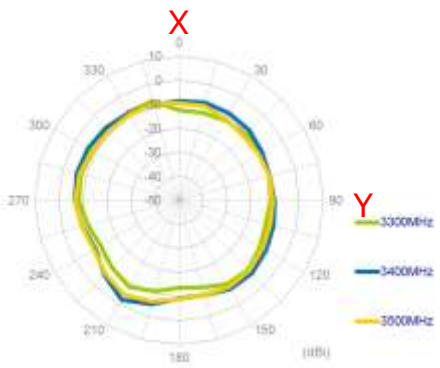
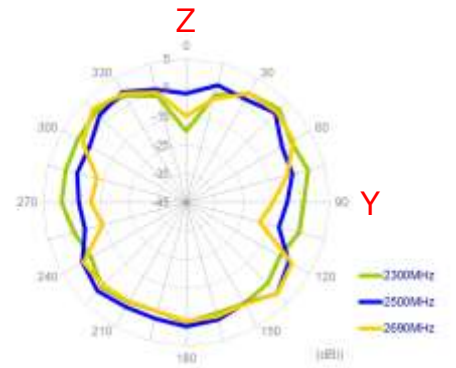
XY Plane



XZ Plane



YZ Plane

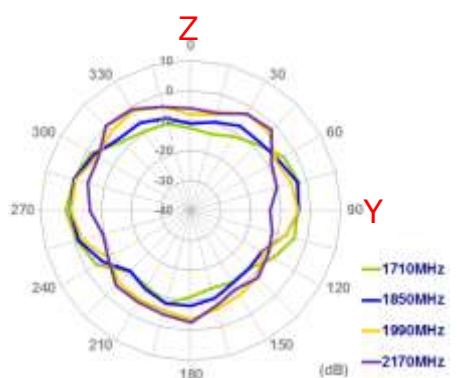
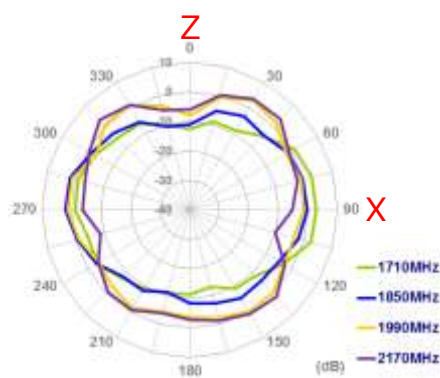
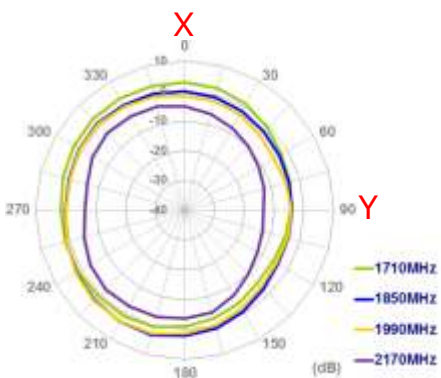
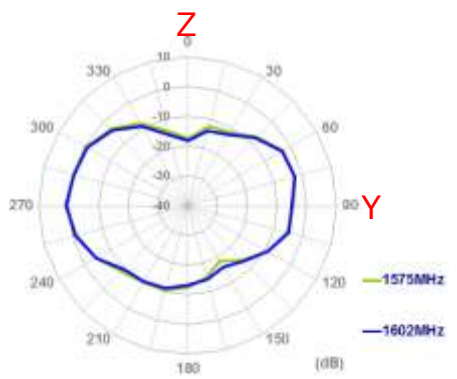
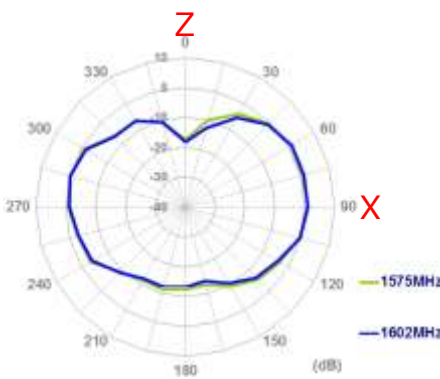
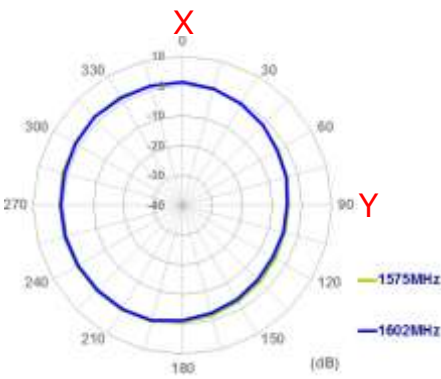
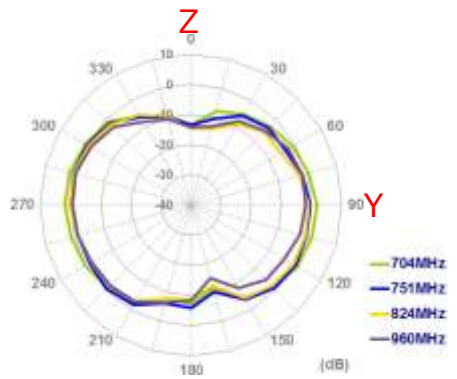
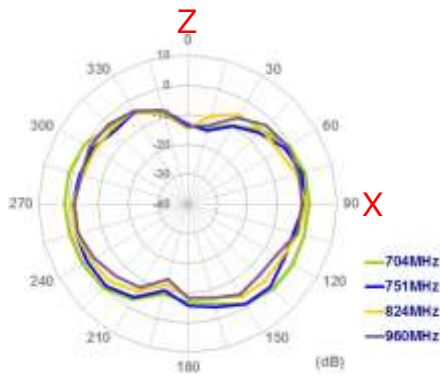
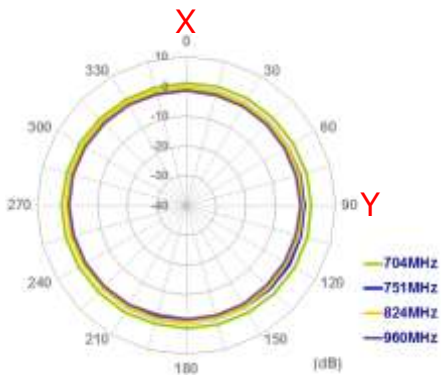


### 4.3. 1 Meter Cable Length on Glass Base

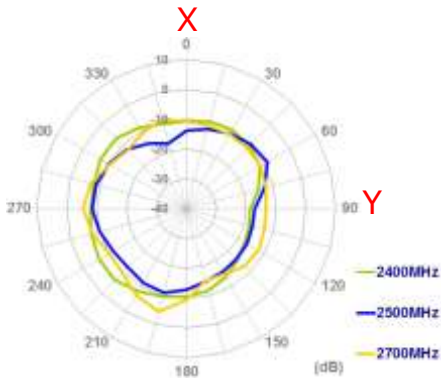
XY Plane

XZ Plane

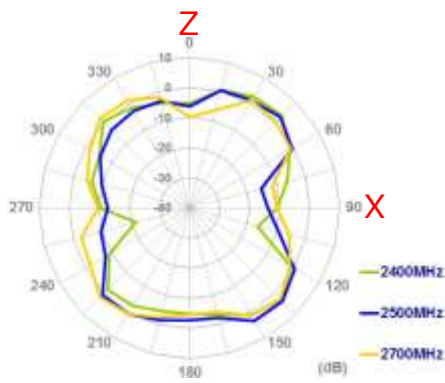
YZ Plane



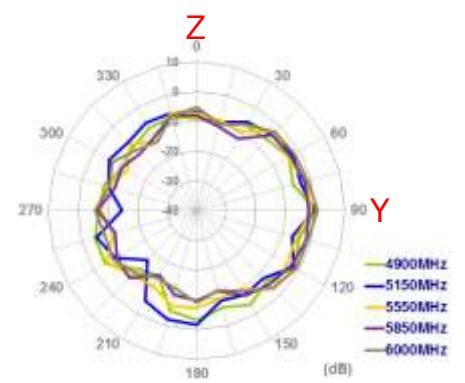
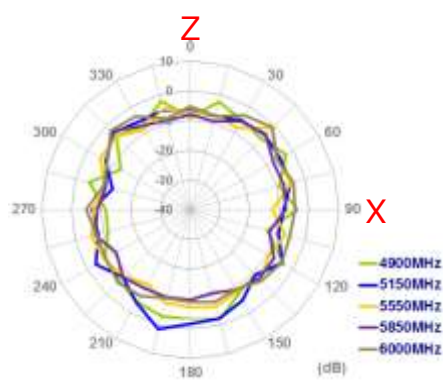
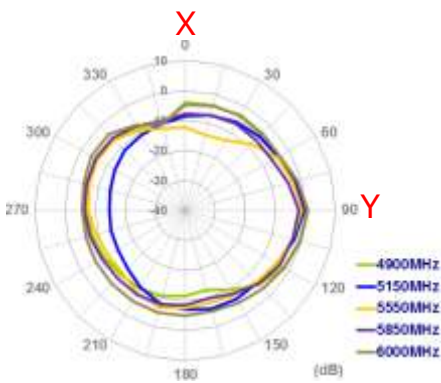
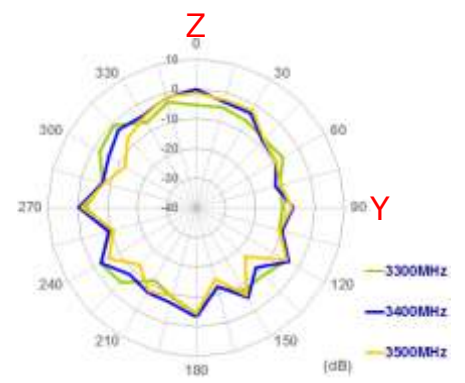
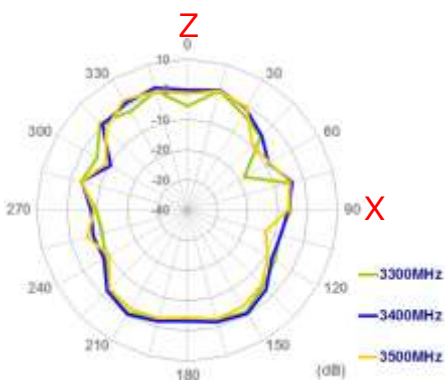
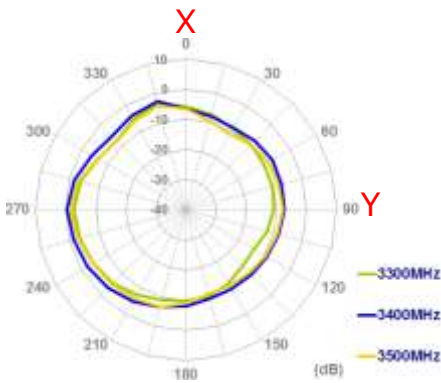
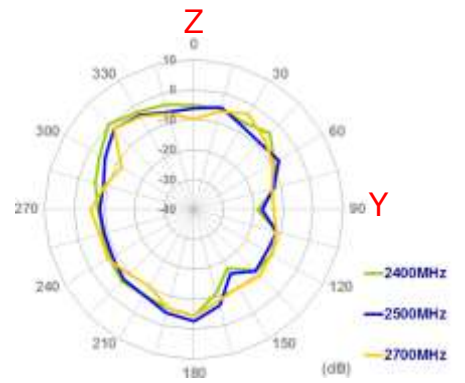
XY Plane



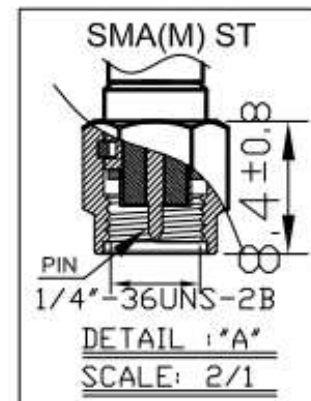
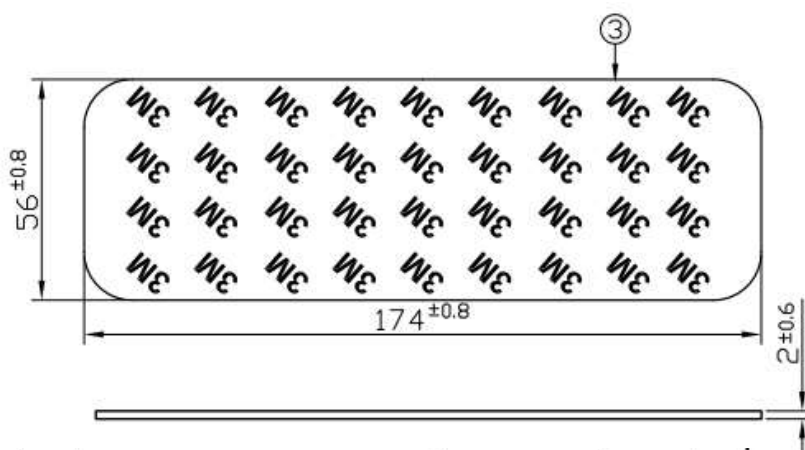
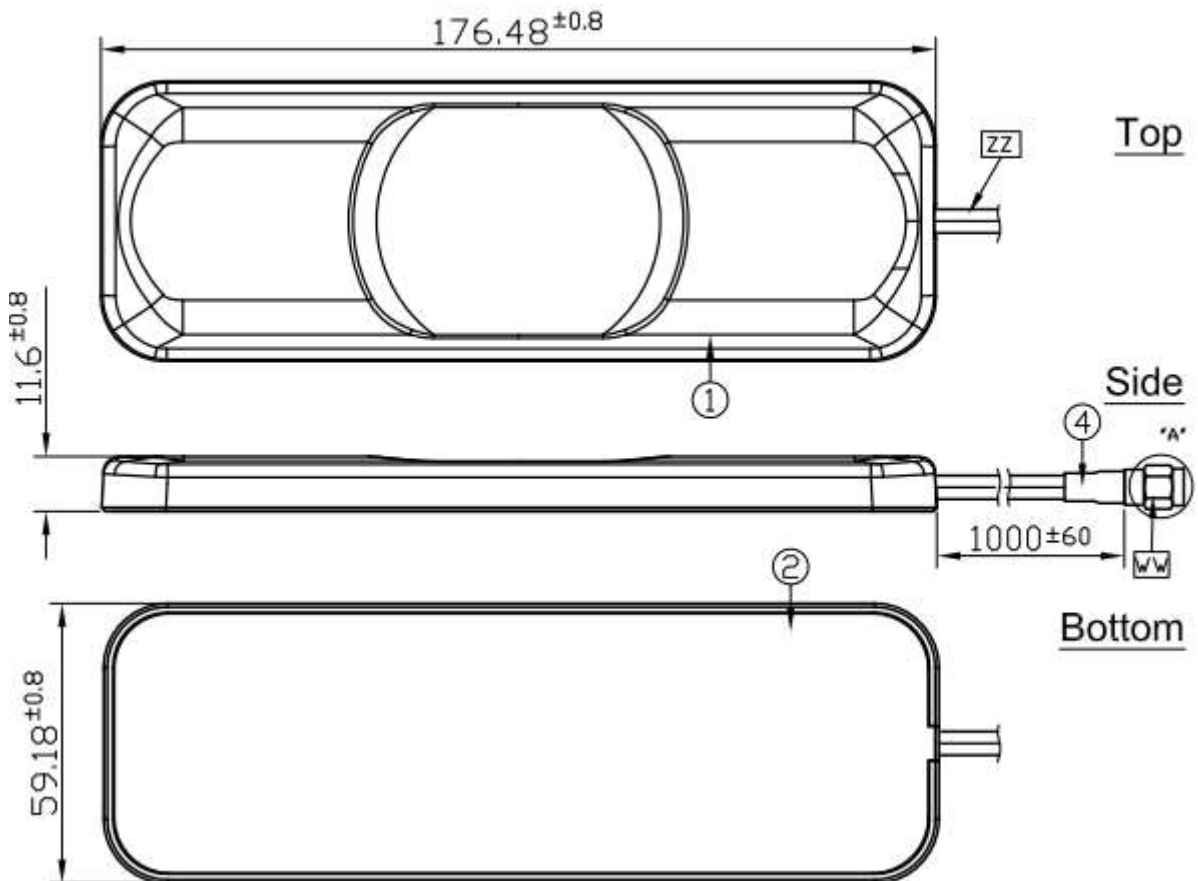
XZ Plane



YZ Plane



## 5. Drawing

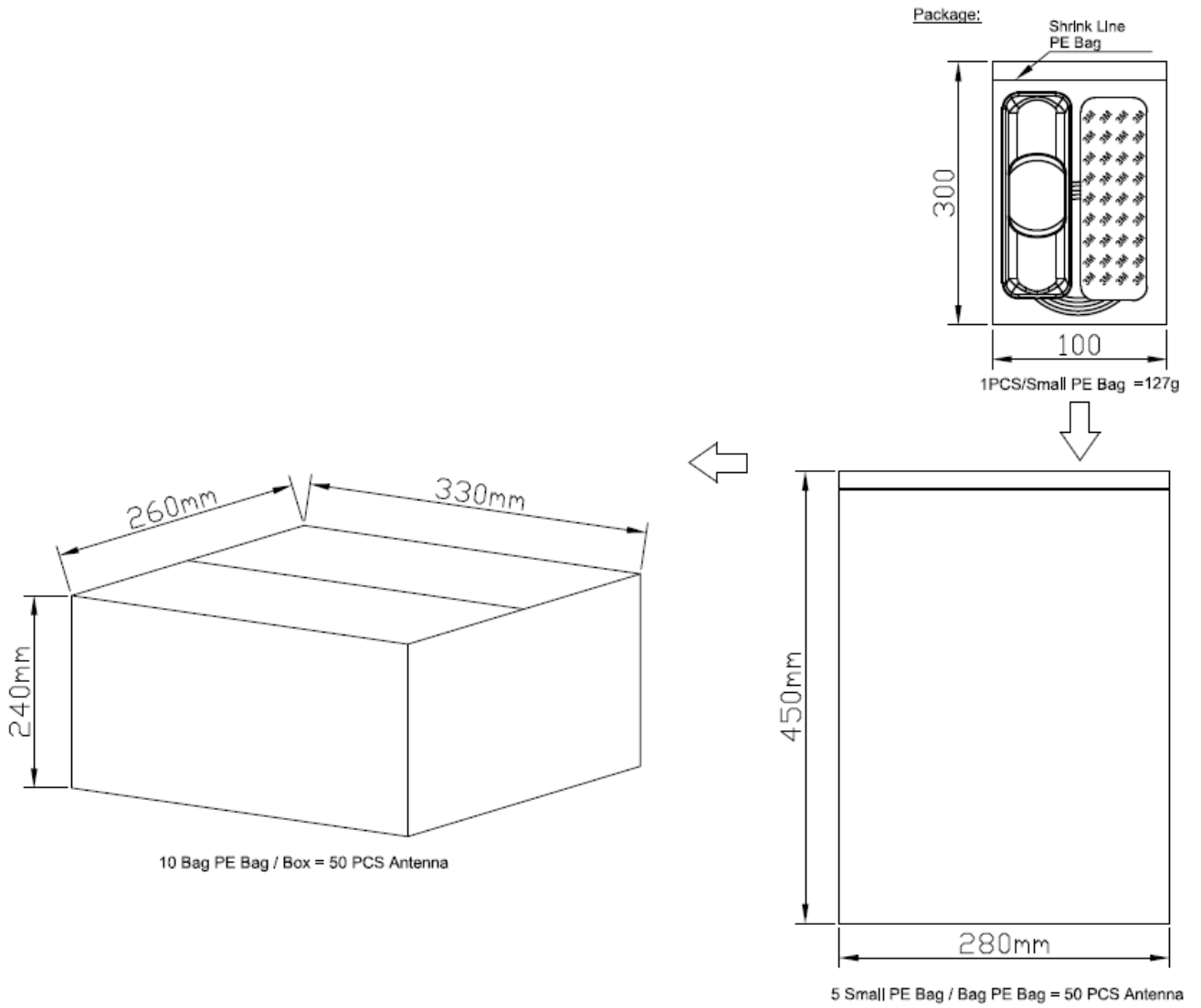


Name	Material	Finish	QTY
1 Housing Top GSA8841	ABS	Black	1
2 Housing Bottom GSA8841	ABS	Black	1
3 3M Double Sided Adhesive With Foam	3M9448+CR4305	Black	1
4 Heat Shrink Tube (CFD 200)	PE	Black	1

Name	Spec	Finish	QTY
WW Connector Type	SMA(M) ST	Gold	1
ZZ Cable Type	NFC 200	Black	1

## 6. Packaging



## 7. Application Note

The GSA.8841 antenna measurement with difference cable length and difference environments, the performance is shown as below,

### 7.1. Return Loss (in free space)

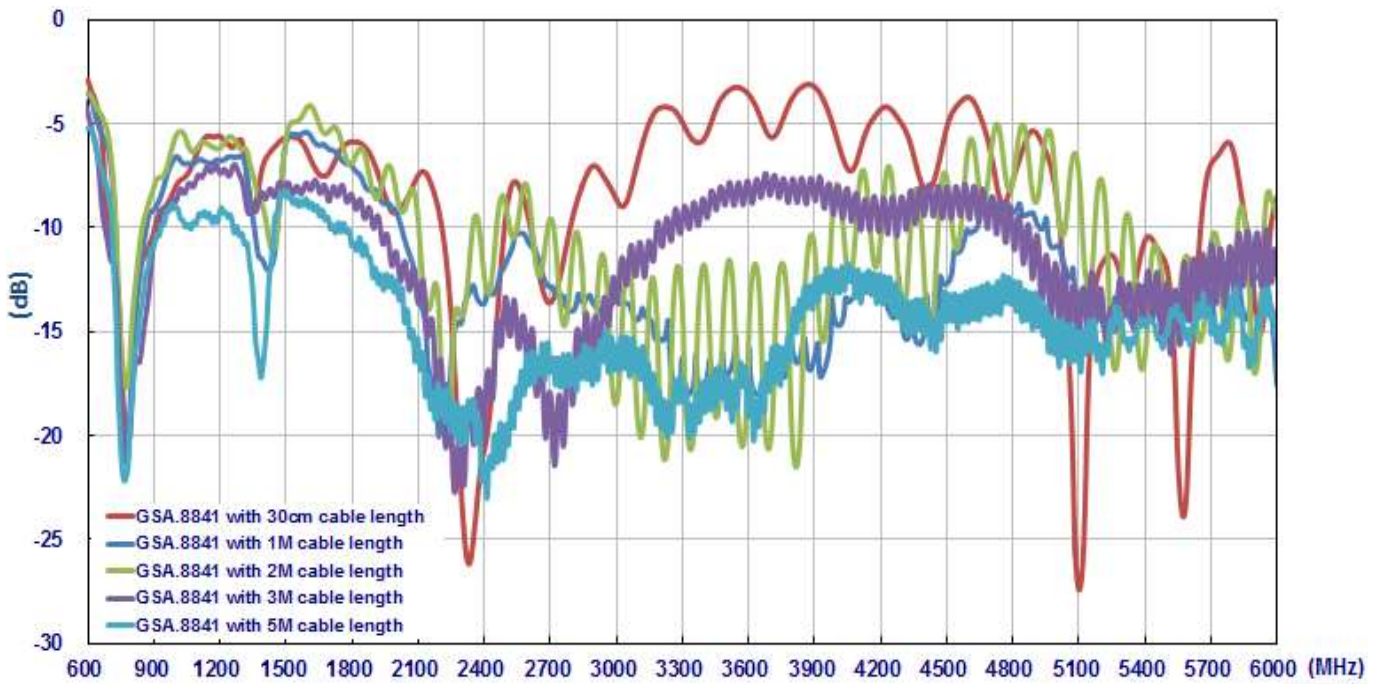


Figure 15. Measured the return loss of GSA.8841 Antenna with difference cable length

## 7.2. Efficiency (In free space)

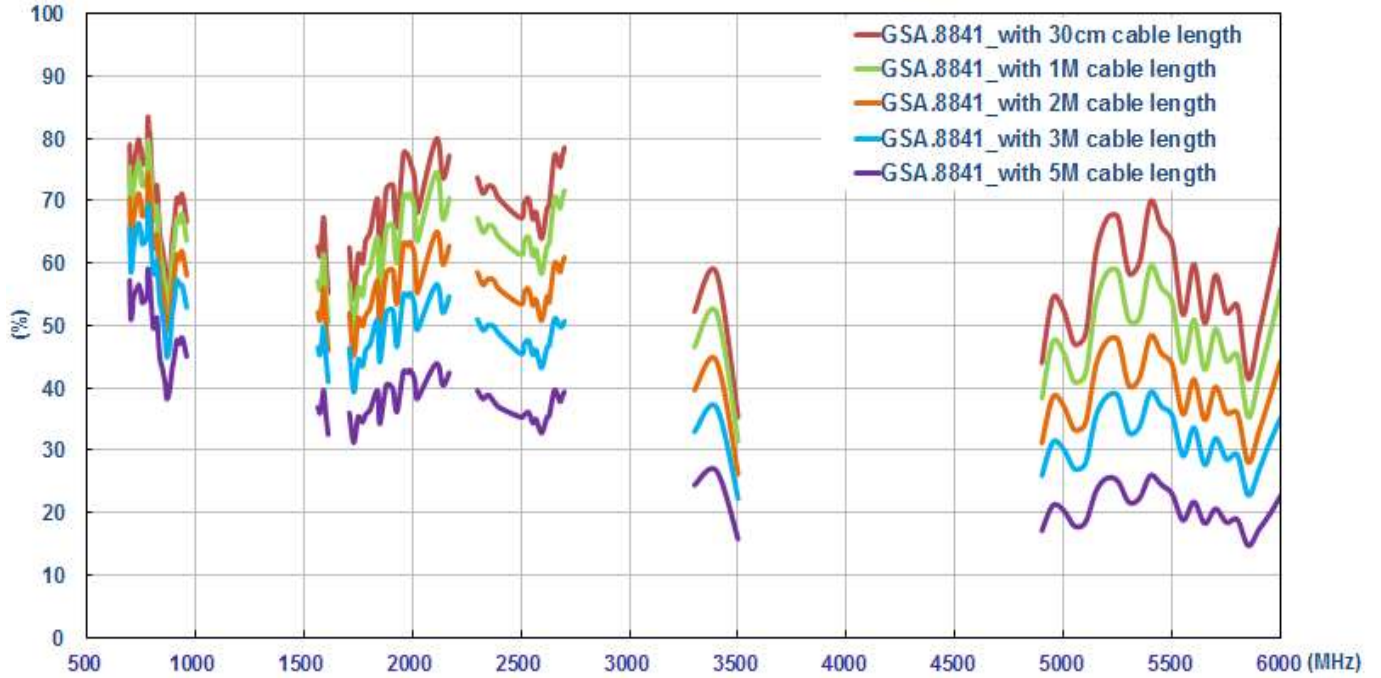


Figure 16. Measured the efficiency of GSA.8841 Antenna with difference cable length

## 7.3. Average Gain (In free space)

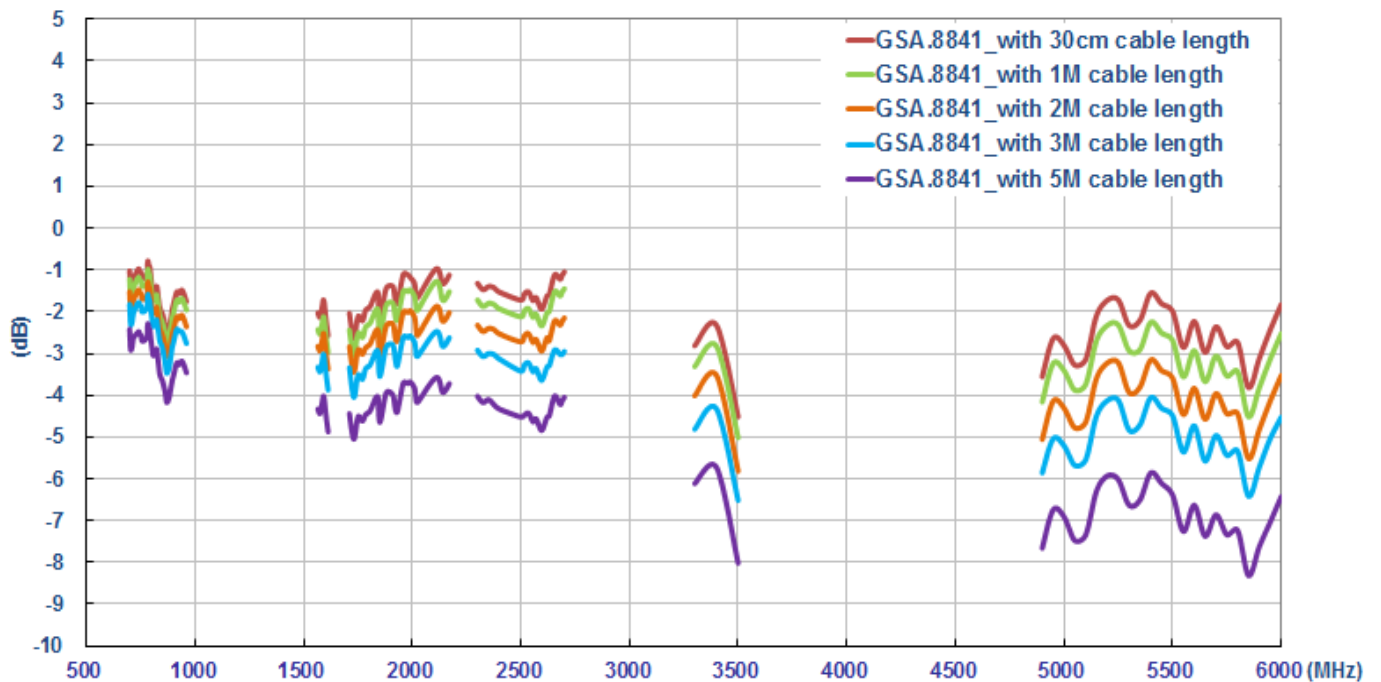


Figure 17. Measured the Average Gain of GSA.8841 Antenna with difference cable length

### 7.4. Peak Gain (In free space)

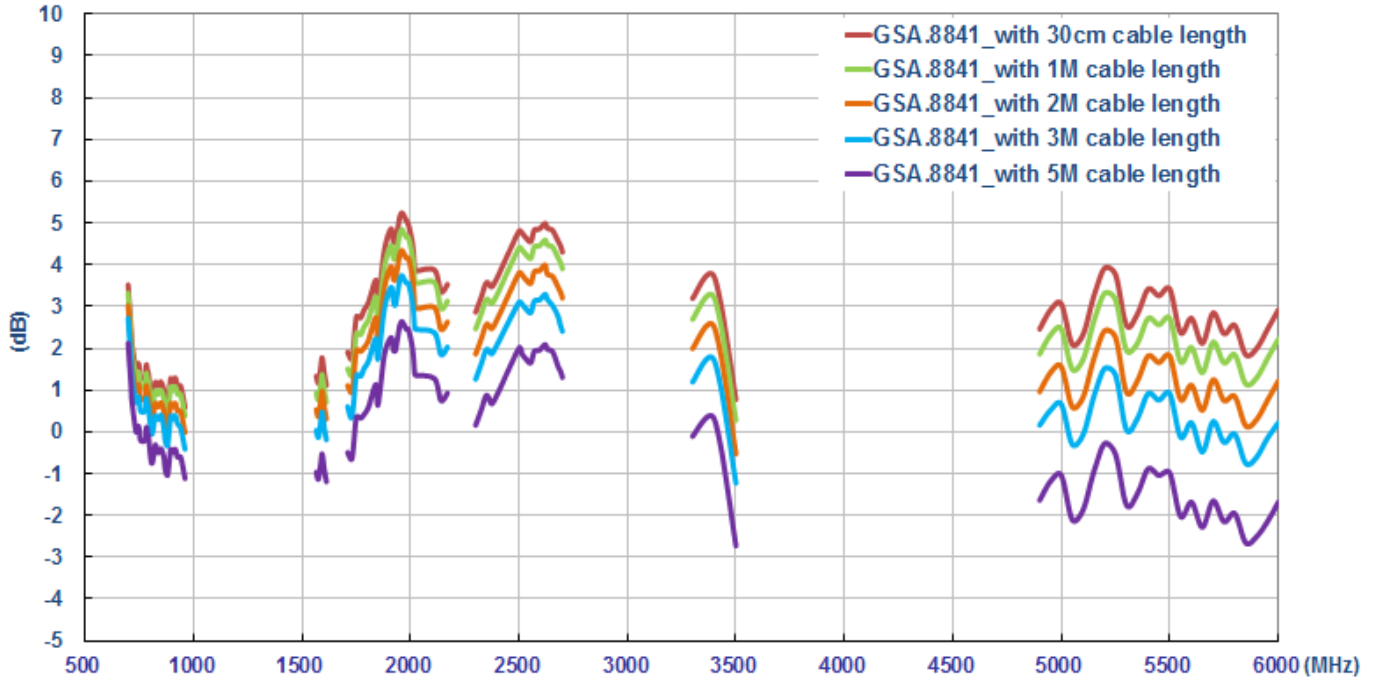


Figure 18. Measured the Peak Gain of GSA.8841 Antenna with difference cable length

### 7.5. Return loss (On the 2mm ABS base)

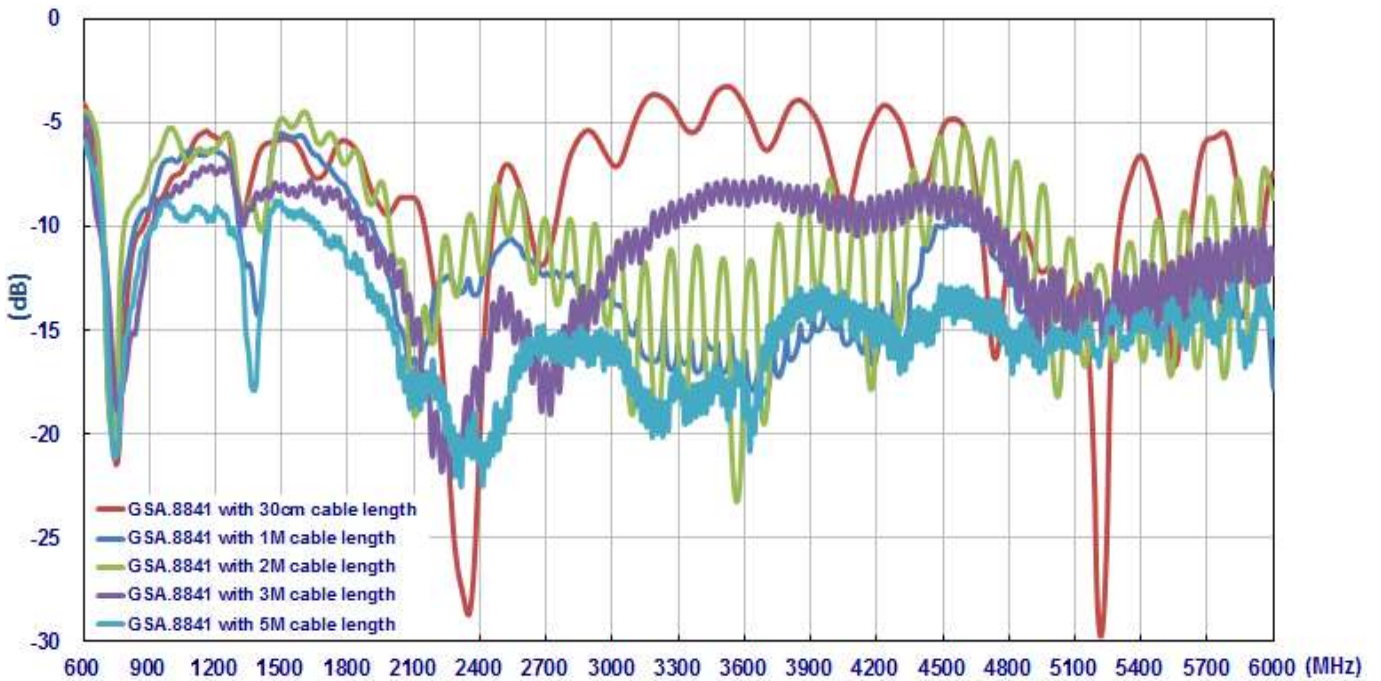


Figure 19. Measured the return loss of GSA.8841 Antenna with difference cable length



### 7.6. Efficiency (On the 2mm ABS base)

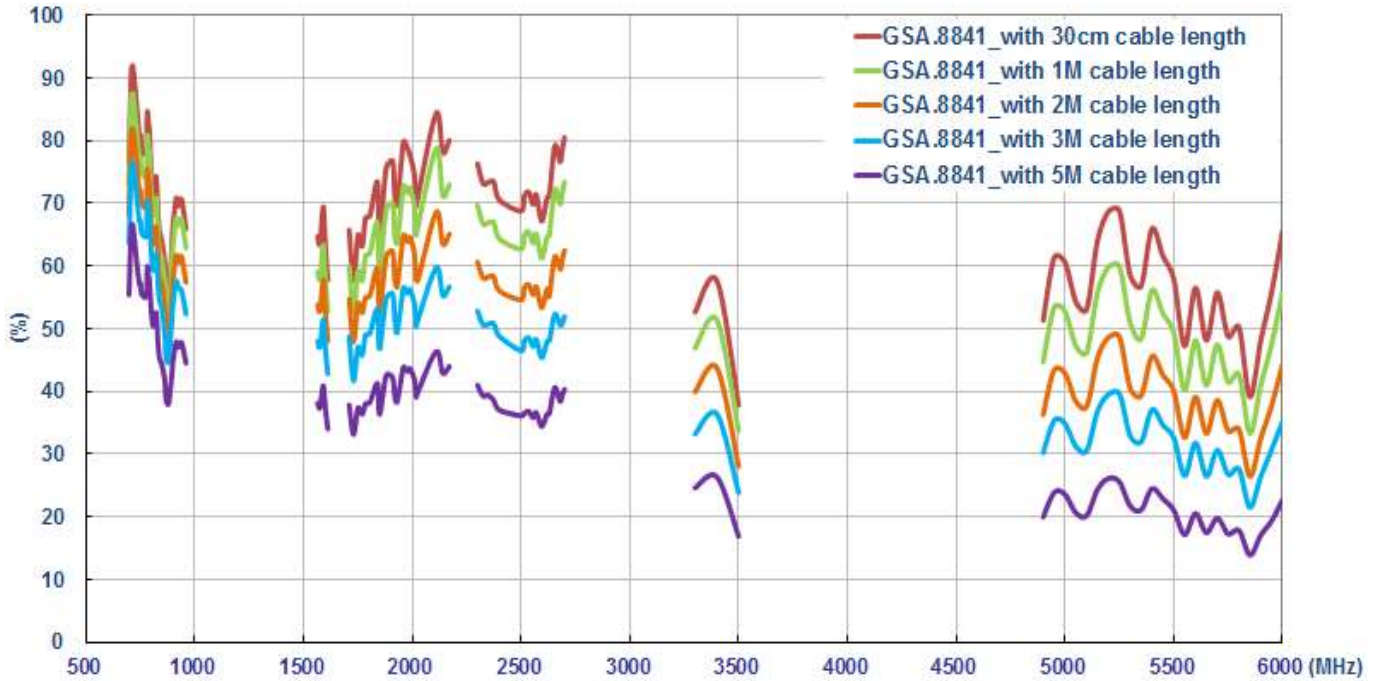


Figure 20. Measured the efficiency of GSA.8841 Antenna with difference cable length

### 7.7. Average Gain (On the 2mm ABS base)

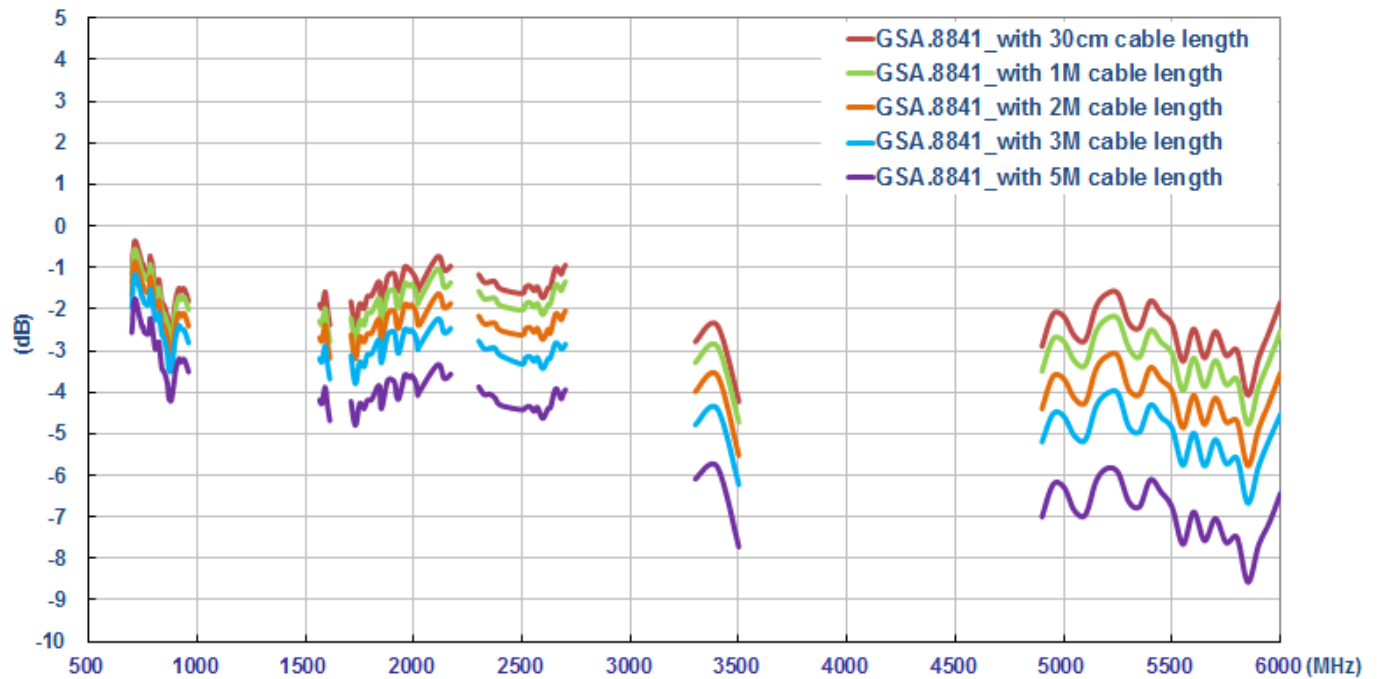


Figure 21. Measured the Average Gain of GSA.8841 Antenna with difference cable length

### 7.8. Peak Gain (On the 2mm ABS base)

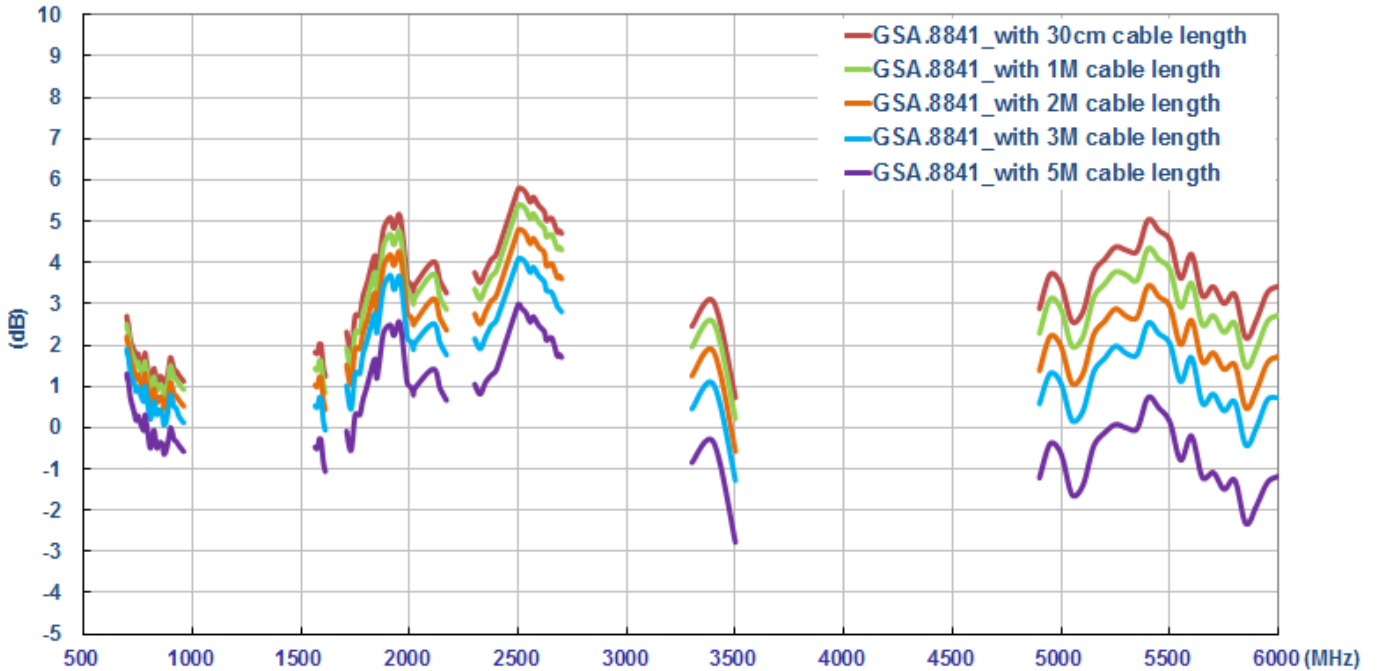


Figure 22. Measured the Peak Gain of GSA.8841 Antenna with difference cable length

### 7.9. Return loss (On the glass base)

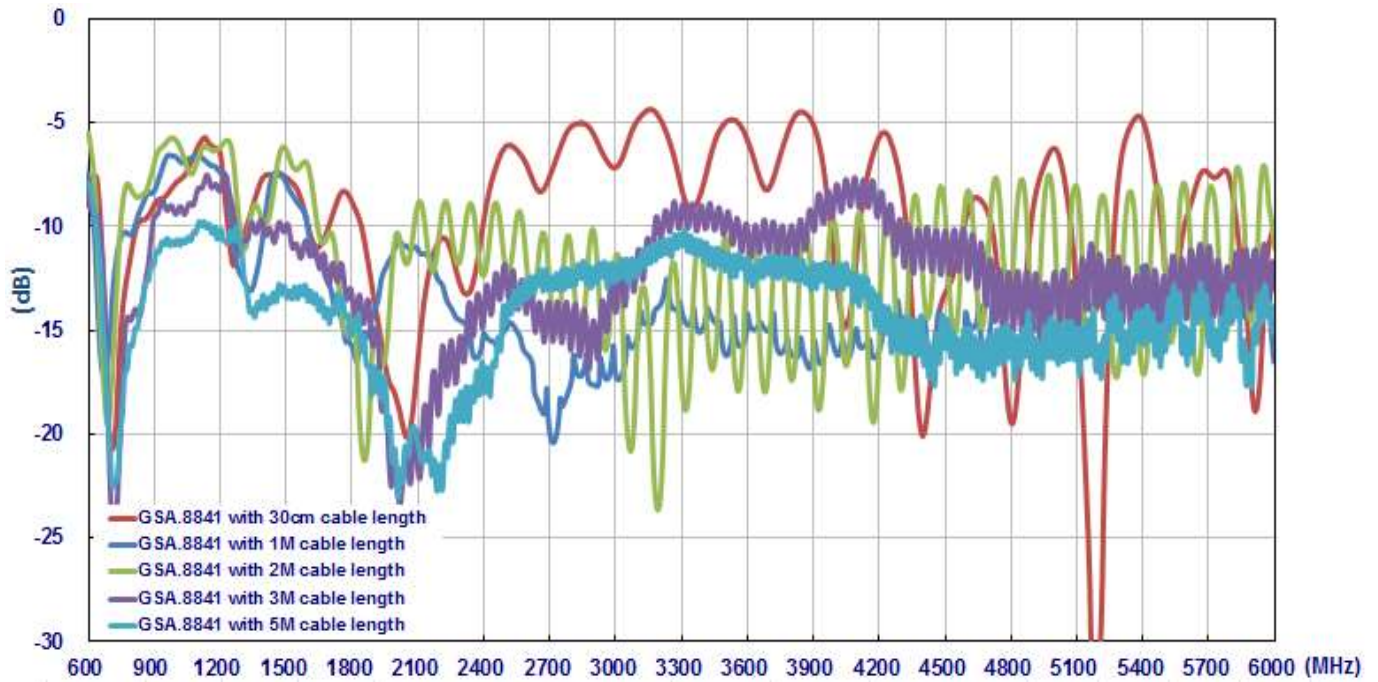


Figure 23. Measured the return loss of GSA.8841 Antenna with difference cable length

### 7.10. Efficiency (On the glass base)

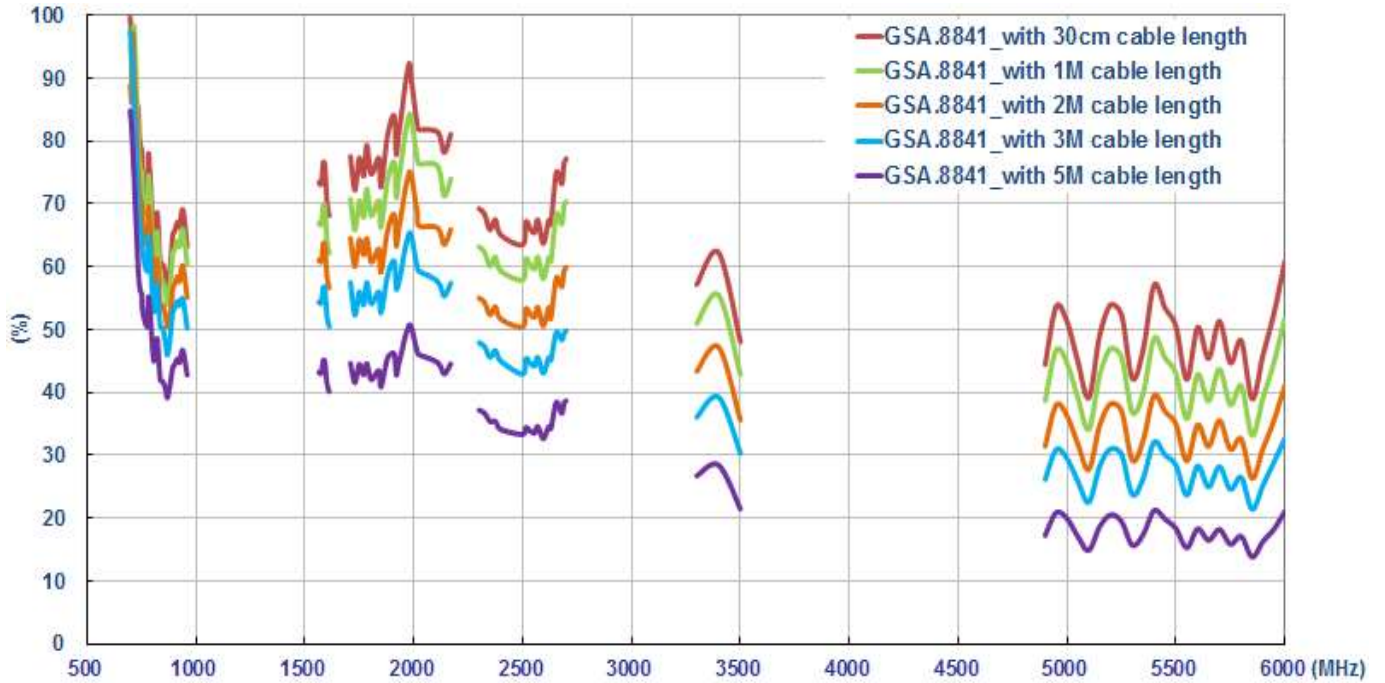


Figure 24. Measured the efficiency of GSA.8841 Antenna with difference cable length

### 7.11. Average Gain (On the glass base)

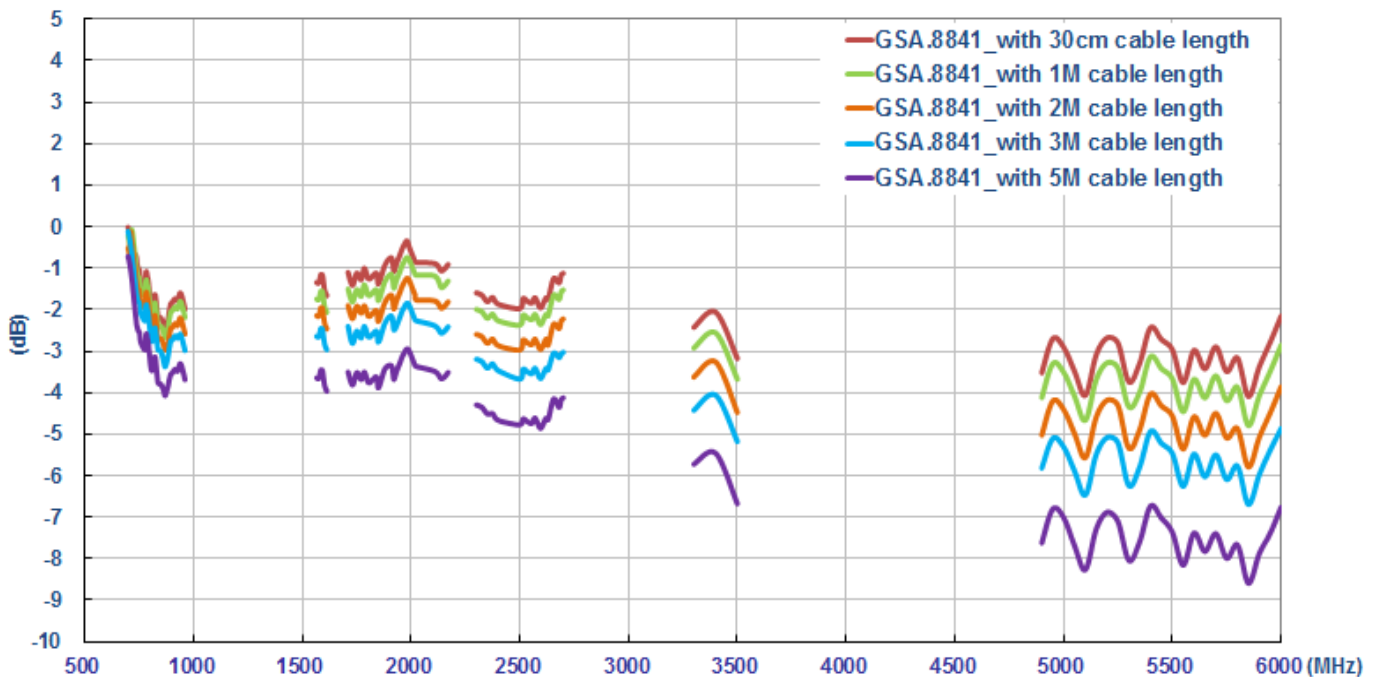
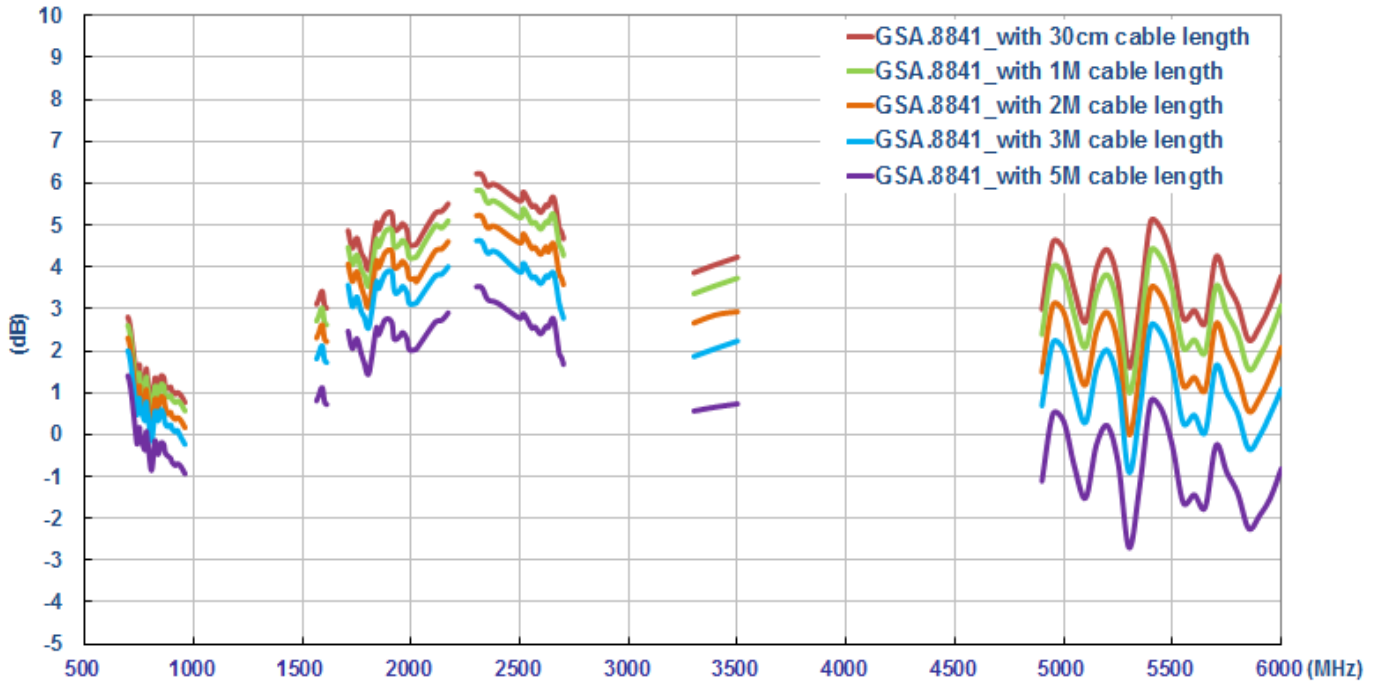


Figure 25. Measured the Average Gain of GSA.8841 Antenna with difference cable length

## 7.12. Peak Gain (On the glass base)



**Figure 26.** Measured the Peak Gain of GSA.8841 Antenna with difference cable length

Taoglas makes no warranties based on the accuracy or completeness of the contents of this document and reserves the right to make changes to specifications and product descriptions at any time without notice. Taoglas reserves all rights to this document and the information contained herein.

Reproduction, use or disclosure to third parties without express permission is strictly prohibited.

Copyright © Taoglas Ltd.